

MASTER CATALOG

HARVESTING | HAY/FORAGE | FARM SUPPLIES | PLANTER PARTS | TILLAGE TOOLS

***HERSCHEL PARTS***<sup>™</sup>  
Quality Ag Parts Since 1887

WWW.HERSCHELPARTS.COM | 888-828-3276



**COMMITTED TO QUALITY, SERVICE AND SELECTION SINCE 1887**

***Our Agricultural Background***

Founded in 1887, by two brothers, Paul E and H. Robert Herschel. R. Herschel Manufacturing quickly became a leader in the sickle section industry.

For more than 130 years HERSCHEL has been an innovator in the cutting parts industry and introduced the chrome plated section (1950), Tiger Jaw®(1981) and Tiger Jaw 2000®(1997) combine conversion kits, Super 7® sections (1992) and most recently the Tiger Shark™ section (2016). Cutting parts designed to provide the agricultural industry with a high quality product at an exceptional value. We are proud to still make our popular cutting products at our factory in Indianola, IA.

In 1995, Herschel Manufacturing decided to expand their tillage market and made the decision to purchase ADAMS Hard-Facing. Adams Hard-Facing was founded in 1927 by W.E. Adams and was known for long wearing, high quality hard-faced and plain tillage tool parts. The addition of these unique and high quality parts to this product line has enhanced our industry-leading position in tillage. We have proudly continued to make high quality tillage tools like our Terminator Sweeps at our factory in Indianola, IA.

These fine products are available from a SINGLE SOURCE, Herschel Parts! The ultimate in PARTS quality, value, and service!

**How To Order From Herschel Parts**

**Toll-Free Phone: 888-828-3276**

Customer Service Reps Are Available Monday - Friday from 8:00 am - 4:30 pm CST.

**Online** at [www.herschelparts.com](http://www.herschelparts.com)

**Store/Mail Order:** 1301 N 14th Street, Indianola IA 50125

**Why buy anywhere else when you can buy direct from the factory?**

**We are the exclusive distributor of the following:**

**TIGER SHARK™**



**TERMINATOR SWEEPS**

**flo-rite**  
seed firmers

**Get the Adams Edge™**

**1-Year Guarantee On Everything We Offer!**

**CONNECT WITH US!**



**Order Online [www.herschelparts.com](http://www.herschelparts.com)  
Toll-Free Customer Service 888-828-3276  
Mail Order/Store 1301 N 14th Street Indianola, IA 50125**

## A

Adapters & Couplers .....	194 - 195
Aerosols.....	191
Alfalfa Spikes.....	177
Application Charts	
Chisel Sweeps .....	143
Disc Blades .....	142
Field Cultivator Sweeps ...	143
Anhydrous Knives.....	182

## B

Baler, Round	
Belts, Lacing ....	104, 115, 116
Gathering Wheels .....	105
Pickup Bands .....	103
Teeth.....	61, 82, 102
Bale Spears.....	198
Baler Teeth.....	110 - 101
Bearings	
Disc.....	159-162
Drill Disc.....	185
Gauge Wheel.....	164
Bearing Flanges	
Pillow Block.....	195
Belts	
Baler.....	115
Lacing Tools.....	116
Row Crop.....	46
Blades	
Coulter .....	153, 155
Disc.....	154 - 155
Disc Mower .....	117 - 120
Drill Disc.....	185
Harrow .....	154 - 155
Peanut.....	175
Rotary Cutter.....	123
Vertical Tillage .....	157
Bolts	
#3 Head Plow.....	148
Chrome Plated .....	148
Clipped Head .....	148
Elliptical Head .....	148
Grain Drill.....	185
Section.....	84
Brake Cleaner.....	191

## C

Carb & Choke Cleaner .....	191
Chain & Cable Lube .....	191
Chains	
Covering.....	183
Roller.....	196
Row Crop.....	46
Steel Detachable.....	196
Chisel Plows	
Points.....	177 - 178
Sweeps .....	176 - 177
Clamp, Danish Tines .....	176
Clips, Hammer Lock .....	148, 173, 174
Closing Wheels.....	164
Combine Conversion Kits .....	125 - 127
Combine Teeth.....	102

## C CONTINUED

Coulter Blades .....	153, 155, 158
Bubble.....	153
Concave.....	153
Fertilizer .....	153
Fluted/Rippled.....	153
Forges De Niaux .....	155
Plain/Flat.....	153
Unverferth .....	158
Wavy.....	153
Couplers .....	195
Covering Chains .....	183
Cultivator Parts	
Field Cultivator .....	173
Row Crop .....	173
S-Tine .....	176
Cutting Parts	
AGCO-Allis.....	3 - 7
Blackwelder.....	8
Cereal .....	8
Case-IH.....	9 - 20
Caterpillar.....	21
Field Queen .....	21
FMC .....	21
Gehl .....	22
Hart Carter .....	23
Honey Bee .....	30
JE Love .....	31
John Deere .....	32 - 48
Johnson .....	49
Kosch.....	50
MacDon.....	51 - 54
Massey.....	55 - 61
New Holland.....	62 - 75
New Idea.....	76 - 77
Owatonna.....	78
Rowse.....	79
Schumacher .....	80
Triumph.....	81
Vermeer .....	82
White.....	83
Universal.....	84 - 87

## D

Danish Tines.....	176
Disc Assemblies .....	183 - 184
Disc Blades.....	154 - 155
Cone Style .....	154
Deep Tillage.....	158
Flat Center .....	155, 156
Notched.....	154, 155
Plain .....	154, 155
Vertical.....	157
Disc Harrow Bearings.....	159 - 162
Disc Mower Knives.....	117 - 120
Disc Openers.....	183 - 184

## D CONTINUED

Disc Replacement Parts .....	163
Case-IH.....	163
John Deere .....	163
Sunflower .....	163
Drawbar .....	193
Drivelines.....	122
Dust Caps.....	185

## F

Ferobide .....	180
Fertilizer Tubes.....	185
Flo-Rite .....	170 - 172
Forage Harvester Teeth .....	110 - 102
Furrowers .....	174

## G

Glass Cleaner.....	191
Grain Drill Replacement Parts, JD.	185
Grain Drill Spacers .....	185
Graphite Lubricant.....	191
Graphite Powder.....	172
Guards .....	121 - 100

## H

Harrow Shoes.....	181
Harrow Tines .....	181
Hitch Pin .....	192
Hoes .....	178
Crescent .....	178
Tender Plant .....	178
Hydraulic Adapters .....	194
Hydraulic Cylinders.....	194
Hydraulic Hose .....	194

## J

Jacks .....	188
-------------	-----

## L

Lacing, Baler.....	116
Landsides .....	150
Lift Arm Pins, Hitch.....	193
Lights .....	189 - 190

## M

Moldboards.....	149
-----------------	-----

*Continued On Next Page*

# MASTER INDEX

## P

Paint .....	186 - 187
Planter Parts	
Bearings.....	164
Closing Wheels.....	164
Disc Openers .....	183 - 184
Flo-Rite®.....	170 - 171
Gauge Wheels.....	164
Gauge Wheel Halves.....	164
John Deere Parts....	165 - 169
Kinze.....	169
Seed Firmers .....	170 - 171
Tires.....	164
Peanut Blades .....	175
Pickup Bands.....	103
Pillow Block Bearing Flanges .....	195
Plow Shins.....	149
Plowshares.....	150 - 152
Points	
Chisel.....	177 - 178
Drill.....	183
Springtooth.....	174
Subsoiler/Ripper Points ...	179
PTO Drivelines .....	122

## R

Rake/Baler/Tedder Teeth ....	105 - 105
Rake Wheels .....	101
Ripper Points .....	179
Rotary Cutter Bolts .....	124
Rotary Cutter Blades .....	123
Rotary Cutter Drivelines .....	122
Rotary Cutter Tailwheels .....	121

## S

Safety Equipment.....	192
Seed Boots.....	185
Seed Firmers, Flo-Rite .....	170 - 171
Seed Tubes .....	185
Shares, Plow .....	150 - 152
Shares, Upset Forged .....	152
Shank Saver.....	148, 178
Shins .....	149
Slim Shank Spoons .....	174
Stem Angles	
Chisel Plows .....	146 - 147
Field Cultivators .....	144 - 145
Subsoiler Caps .....	179
Sweeps	
Alabama.....	175
Chisel.....	176 - 177
Danish.....	176
Field Cultivator.....	173
Hammer-Lock .....	174
Heel.....	174

## Sweeps Continued .....

Joyce.....	175
N-Series .....	173
Row Crop.....	173
Slim Shank.....	174
Terminator II.....	174
V-Plow/Wing .....	175
Wheatland.....	176 - 178
Wing.....	177

## T

Talc Powder.....	172
Technical Information	
Landside .....	131 - 132
Moldboard.....	129, 138 - 139
Plowshare .....	133 - 137
Shins .....	139 - 140
Tillage .....	141
Tedder Teeth.....	102
Tie-Rod Cylinders.....	194
Tines	
Danish.....	176
Harrow .....	181
Tires .....	165
Toplink Parts.....	193
Toplinks .....	193
Trash Shields.....	185

<b>B</b>	
Bale Counter.....	5
Bearings, Plastic Reel .....	6
Board, Grass .....	5
Bolts, Section .....	5
<b>C</b>	
Clips, Hold Down .....	5
<b>E</b>	
End Sections .....	4
<b>G</b>	
Gathering Chain Sprockets .....	7
Grass Board .....	5
Guards.....	6
<b>H</b>	
Hammer Rivet Tool.....	7
Hold Down Clips.....	5
<b>I</b>	
Idler Pulleys .....	7
<b>P</b>	
Pick-Up Teeth.....	7
Plastic Reel Bearings .....	7
Plastic Tines .....	7
Poly Replacement Parts.....	7
Pulleys, Idler .....	7

<b>R</b>	
Reel Tines .....	7
Rivets, Section.....	5
<b>S</b>	
Sections.....	4
Section Bolts.....	5
Section Rivets.....	5
Sickle Assemblies.....	6
Sickle Heads.....	5
Splice Kit.....	5
<b>T</b>	
Teeth, Pick-up .....	7
Tines, Reel .....	7
<b>W</b>	
Wear Plate.....	5

HERSCHEL sections are made in the USA from high quality boron steel. Heat-treated for long life. Sections are extra heavy (.116") and chrome unless stated otherwise.

All AGCO-ALLIS sections have 2" hole spacing.

### SECTION TYPES

7TS = Super 7® Top Serrated  
 SM = Smooth  
 US = Under Serrated - 14 Tooth  
 TS = Top Serrated - 14 Tooth  
 TT = Tiger Tooth  
 TJ = Tiger Jaw  
 SRK = Tiger Shark™



### UNIVERSAL SECTIONS

Fits all AGCO-ALLIS Mowers. Section is 3" x 3-1/16". Uses 9/16 OH rivet. Sold 10 sections per pack.

OEM Number	Application	Design	Order No.	List
70802535	XHSM	H	S20-1142	13.22
70802541	XHUS	A-	S20-5246	11.24
70804709	XHUSCR	A	S20-6344	20.22



### SECTION - XH7TSCR - H+ TYPE

Section is 3" x 2-1/2". Uses 5/8 CS rivet. Sold 10 sections per pack. Replaces OEM SS1176531. Bottom countersunk.

Order No.	List
S20-4322	17.46



### SECTION - XHTSCR - H TYPE

Fits AGCO-ALLIS Combines, Floating Bar (soybean) Series 1 & 2. Section is 3" x 2-1/2". Uses 5/8 CS rivet. Sold 10 sections per pack. Replaces OEM 71176531. Bottom countersunk.

Order No.	List
S20-4462	18.81



### SECTION - XHTSCR - O TYPE

Fits AGCO-ALLIS Series 3, 300, 400, 500, 700, 800, 7000, 7200, 8000, 8200, 9250, 9255 with Bolt On Sections. Section is 3" x 2-7/8". Sold 10 sections per pack. Top countersunk. Use TJ55 bolt. Replaces 71348175.

Order No.	List
S20-4279	16.33



### SECTION - XH7TSCR - O+ TYPE

Fits AGCO-ALLIS 7000, 7200, 8000, 8200, 9250, 9255, MF9250. Fits non-floating platforms & series III with riveted sections. Section is 3" x 2-7/8". Sold 10 sections per pack. Use 9/16 OH rivet. Replaces 71426346.

Order No.	List
S20-4285	15.92



### SECTION - XHSRKCR

Fits AGCO-ALLIS Series III to 9255. Section is 3" x 2-7/8". Uses 5/8 CS rivet. Sold 25 sections per pack. Replaces OEM 71135135.

Order No.	List
S20-8279	15.40



### TIGER JAW SECTIONS

Fits all AGCO-ALLIS Combines with Tiger Jaw systems. Section is 3" x 2-1/4". Uses TJ55BN bolt. Sold 10 sections per pack.

Replaces Number	Description	Design	Order No.	List
TJ6000	XHTJCR	S	S20-4638	26.71
SSTJ6000	XH7TJCR	S+	S20-4316	17.62

### UNIVERSAL END SECTIONS

HERSCHEL "End Sections" are made of one-piece high carbon, heat-treated steel for rugged use. They are punched with an oblong hole to virtually fit any standard cutterbar mower in use today. To install our "End Section", simply take off the last section on the shoe end of your sickle assembly and replace it with an "End Section". The change-over takes only a couple of minutes to complete and you will notice a big difference in time saved from unclogging your mower. We recommend using a R36-0523D oval head rivets or B55-0065D Bolts.

Description	Order No.	List	Description	Order No.	List
XH7TSCR (RH) 10/Box	S20-4403	38.49	Tiger Shark™ (LH) 2/SP	S20-8445D	12.06
XH7TSCR (RH) 2/SP	S20-4403D	10.54	XHTS CR (RH) 10/Box	S20-4210	38.49
Tiger Shark™ (RH) 10/Box	S20-8403	45.13	XHTS CR (RH) 2/SP	S20-4210D	10.54
Tiger Shark™ (RH) 2/SP	S20-8403D	12.06	XHTSCR (LH) 10/Box	S20-4211	38.49
XH7TSCR (LH) 10/Box	S20-4445	41.22	XHTSCR (LH) 2/SP	S20-4211D	10.54
XH7TSCR (LH) 2/SP	S20-4445D	13.94	XHUSCR (RH) 10/Box	S20-6640	40.77
Tiger Shark™ (LH) 10/Box	S20-8445	45.13	XHUSCR (RH) 2/SP	S20-6640D	10.54



**1-YEAR WARRANTY ON ALL ITEMS!**

**HOLD DOWN CLIPS  
NON-ADJUSTABLE**



Fits all AGCO-ALLIS Combines. Steel.

Style	Order No.	List
Low Arch	C45-0063	6.69



Fits all AGCO-ALLIS Mowers, Rigid & Flex, Combine, Except Hart Cart. Steel.

Style	Order No.	List
Low Arch	C45-0692	3.57
High Arch	C45-0693	4.79

**HOLD DOWN CLIPS  
ADJUSTABLE**



Fits all AGCO-ALLIS Mowers & Mower Conditioners. Cast.

Style	Order No.	List
Low Arch	C45-0006	21.39
High Arch	C45-0007	21.39



Fits most AGCO-ALLIS Combines, Mowers & Windrowers, except Hart-Carter & Love. Steel.

Style	Order No.	List
Low Arch	C45-0040	5.65

**SECTION BOLTS**

Description	Application	Qty. Pkg.	Mstr. Ctn.	Order No.	List
Overlap Bolt w/Low Profile Nut, 1/2" CS	Double Drive Sickles (use with Allen Wrench)	10	60	B55-0059D	7.06
Section Bolt, 9/16"CS	Replaces Rivets for Bolt-on Convenience	20	120	B55-0056D	10.82
Head Bolt, 1" CS	Replaces Rivets for Bolt-on Convenience	10	60	B55-0058D	8.56
Section Bolt w/Nut	Universal - Replaces 9/16" & 5/8" Rivets	50	300	B55-0065D	9.55
Head Bolt w/Nut	Universal - Replaces 1" & 1-1/16" OH Rivets	15	90	B55-0085D	5.85
Head Bolt w/Nut	Universal - Replaces 1-1/4" OH Rivets	12	72	B55-0095D	6.02
Section Bolt w/Nut	Universal - Bolts for 10" Sickle w/head bolts (80 - TJ55BN, 5 - TJ85BN, 5-TJ95BN)	90	Each	B55-0500D	22.76
Nut	Universal	20	120	N83-0289D	5.36



**SECTION RIVETS - ZINC PLATED**

OH = Oval Head CS = Counter Sunk

Size/No. in Pkg.	Application	Qty. Pkg.	Mstr. Ctn.	Order No.	List
5/8" # 5-1/2 (56)	7" Heavy Mower Sections and Knife Heads	Asst.	6	R36-0523D	7.75
1" # 5-1/2 (10)	Mower Conditioners	Asst.	6	R36-0524D	9.39
5/8" # 5-1/2 (72)	Mower Conditioners	Asst.	6	R36-0524D	9.39
1" # 5-1/2 (5)					
1-1/4" # 5-1/2 (5)					
5/8" OH #5-1/2	Heavy Gauge Sections	1#	6#	R36-0462D	13.40
15/16" OH #5-1/2	Head Rivet	1/2#	3#	R36-0522D	6.32
1-1/4" OH #5-1/2	Head Rivet	1/2#	3#	R36-0467D	6.83
5/8" CS #5-1/2	Section Rivet	1#	6#	R36-0463D	10.94
1-1/4" CS #5-1/2	Guard Plate Rivet	1/2#	3#	R36-0468D	6.63



**GRASS BOARD**

Fits all mowers.



Order No.	List
B52-0615	44.40

**BALE COUNTER**

Bale counter, reads up to 99,999. 4-hole mounting plate, push button reset, adjustable side arm. Fits most balers.



Order No.	List
T55-0002	25.30

**SPLICE KIT**



For 2" hole spacing on combines, mowers & mower conditioners. Contains 2 straps, bolts & nut.

Order No.	List
C83-0750	22.80

**WEAR PLATES**



For all AGCO-ALLIS mowers. 6". Replaces W50.

Order No.	List
P44-0591	2.95
P44-0591D*	10.27

\*Display Pack of 2.



For all AGCO-ALLIS combines. 6-7/16". Replaces 1116532.

Order No.	List
P44-0472	3.73



For all AGCO-ALLIS combines. 5-1/2" Replaces 1176537.

Order No.	List
P44-0417	2.53

**SPLICE BOLT & NUT KIT**



For splice segment on all spliced sickles. 12 bolts/nuts per package.

Order No.	List
B55-0049D	8.74

**SICKLE HEADS**

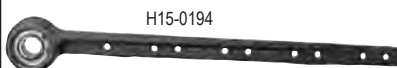

H15-0194

Fits AGCO-ALLIS Combines, Floating Bar Generation 3, HC & Series 2. For wobble drive. Replaces 71307323.

Order No.	List
H15-0194	118.02



H15-0228

Fits AGCO-ALLIS Combines Series 3 prior to S/N 19301. Replaces 71358960.

Order No.	List
H15-0228	102.79



### RIVETED SICKLE - 7 FT

Fits AGCO-ALLIS 7, 80, 80R, 80R3, 80S, 80T, 82R, 82S, 82SH, 82T. Replaces OEM number 70804549.

Head part number is H15-0306, OEM# 70804519.  
Section part number is S20-5246, OEM# 70805241.

# of Sections	Order No	List
28 -XHUS	S35-3716	187.90

### RIVETED SICKLES

Fits AGCO-HART-CARTER FLOATING BAR, HART-CARTER GENERATION III, SERIES II F2, K2, L2, M2, N5, N6, N7 (WOBBLE DRIVE HD). Mounts on end of sickle.

Head part number is H15-0194, OEM# 71307323.  
Section part number is S20-4462, OEM# 71176531.

OEM#	Length	# of Sections	Order No	List
71307333	13'	53 - XHTSCR	S35-4230	333.90

### BOLTED SICKLES - HEADLESS

Fits AGCO-HART-GLEANER F, L, M, MH, R, R40, R50, R52, R62, R70, R72 ALL WITH SERIES III, FLEX, 300, 500, 700, 800 ALL SERIES I & II RIGID 1986-LATER.

Section part number is S20-4285, OEM# SS71135135.  
Spliced sickle will ship UPS.

OEM#	Length	# of Sections	A	B	C	D	Order No	List
71348524	24'	95 - XH7TSCR	1	2	0	1	S35-2807	528.76
71348527	27'	107 - XH7TSCR	1	1	1	1	S35-2808	547.36
71348530	30'	119 - XH7TSCR	1	0	2	1	S35-2809	582.06

### SECTION TYPES

7TS = Super 7<sup>®</sup> Top Serrated  
SM = Smooth  
US = Under Serrated  
TS = Top Serrated  
TT = Tiger Tooth  
TJ = Tiger Jaw  
SRK = Tiger Shark<sup>™</sup>

A	=	8' Head End S35-2801
B	=	4' Extension S35-2802
C	=	7' Extension S35-2803
D	=	8' Tail End S35-2804



### MALLEABLE GUARD 1 PRONG

Fits AGCO-ALLIS MOWERS 3, 4, 5, 7, 80. Replaces DM700 and 70804072.

Order No.	List
G81-0803	7.05

### MALLEABLE GUARD 1 PRONG RIGHT HAND

Fits AGCO-ALLIS MOWERS WITH 7/16" BARS. Replaces DM700R and 70802500.

Order No.	List
G81-0805	9.95



### FORGED GUARD 2 PRONG

Fits AGCO-ALLIS COMBINES, RIGID BAR SERIES A, C, E, R, T, G, F & N. Replaces FC68-2, HA225A, 71116504, 71341601.

Order No.	List
G81-0187	14.12



### FORGED GUARD 2 PRONG

Fits AGCO-ALLIS COMBINES, FLOATING BAR. Replaces FC89-2, HA231, 71176532, 71320143.

Order No.	List
G81-0125	16.78



### FORGED GUARD 2 PRONG

Fits CLASS-CAT CHALLENGER COMBINE. Replaces BU2018H, 676295N.

Order No.	List
G81-0199	14.86



### PLASTIC BEARING KIT

Includes 6 caps, 6 bases, U-Bolts and 12 nuts.

Application: Reels with Wood Bats used on AC Gleaner.

Order No.	List
B15-0915	27.47



### PLASTIC BEARING KIT

Includes 12 bearing halves, 12 bolts, and 12 nuts.

Application: Reels with Tear Drop Bats and Rear Mounted Plastic Tines used on AGCO Gleaner series 3 and 300.

Order No.	List
B15-0920	50.91



### PLASTIC BEARING KIT

Includes 12 bearing halves, 6 bolts, and 6 nuts.

Application: Pipe Reels with Plastic Tines used on AGCO 300, 400, 500, 700, & 800 series.

Order No.	List
B15-0925	24.64

### Our Agricultural Background

Founded in 1887, by two brothers, Paul E and H. Robert Herschel. R. Herschel Manufacturing quickly became a leader in the sickle section industry.

For more than 130 years HERSCHEL has been an innovator in the cutting parts industry and introduced the chrome plated section (1950), Tiger Jaw<sup>®</sup> (1981) and Tiger Jaw 2000<sup>®</sup> (1997) combine conversion kits, Super 7<sup>®</sup> sections (1992) and most recently the Tiger Shark<sup>™</sup> section (2016). Cutting parts designed to provide the agricultural industry with a high quality product at an exceptional value. We are proud to still make our popular cutting products at our factory in Indianola, IA.

**1-YEAR WARRANTY ON ALL ITEMS!**



- PATENTED 2 PIECE DESIGN.
- SAVE MONEY!  
REPLACE ONLY THE TINE.



**HERSCHEL 6" 2-PIECE POLY TINES FOR PIPE REELS**

Fits AGCO-ALLIS 700, & 800, 7000 & 8000 series.

Description	Pkg. Qty.	Order No	List
Tine & Clamp	100/Box	T16-0740	198.88
Tine & Clamp	10/Box	T16-0745	21.80
Tine ONLY	100/Box	T16-0750	130.64

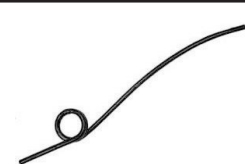

**COMBINE PICKUP REEL**

For Case-New Holland Pickup reels. Replaces H1611. Steel. 100 per box.

Order No.	List
T16-0124	1.60



**NYLON FLEX TINE**

For Case-New Holland 810 Flex & 820, 1020 1987 & Older. Replaces N66A. 1 mounts to front of bat. 100 per box.

Order No.	List
T16-0183	189.12



**NYLON FLEX TINE**

For Case-New Holland 1020 1988 & After. Replaces 1970586C1 and N67A. 1 mounts to rear of bat. 100 per box.

Order No.	List
T16-0767	165.82



**HAMMER RIVET TOOL**

For drive rivets.

Order No	List
T55-0812	30.72



**4" - 2 PIECE M/L REEL TINE**

Most with pipe reels built up to 2000. Most combines. Replaces 782551. 100 per box.

Order No.	List
T16-0720	175.64



**4" - 2 PIECE M/L REEL TINE**

Most with pipe reels built up to 2000. Most combines. Replaces 782226. 10 per bag.

Order No.	List
T16-0715	19.03



**M/L REEL TINE**

For T16-0715 and T16-0720. No clamps. Replaces HA100MLT. 100 per box.

Order No.	List
T16-0725	128.83

**REPLACEMENT SCREW**

For T16-0715 and T16-0720. No clamps. Replaces HA20SC. 20 per box.

Order No.	List
B55-0096D	2.40

**Customer Service**

Our customer service department has over 105 years of combined experience in the agricultural industry. Each team member prides themselves on providing each customer the highest level of service and strive to ensure that each customers needs are meet beyond their expectations. From your most difficult product questions to placing an order, our Customer Service Representatives are here for you!

Our customer service representatives can be reached Monday - Friday from 8 am to 4:30 PM CST.

**Give us a call today!**

**IDLER PULLEYS BY AETNA**

OEM Number	Style	Outer Diam.	Center Hole	Overall Width	Order No	List
70539528	Flat Face	2-3/4"	1/2"	1-1/2"	P83-0609	20.69
71174568	Flat Flanged	5-3/4"	5/8"	1-3/4"	P83-0602	32.82
71145679	Flat Flanged	5-3/4"	5/8"	2-1/8"	P83-0603	38.54

**GATHERING CHAIN IDLER SPROCKET**

Lower idler sprocket, regreasable, 8 tooth, 5/8" hole. For all huggor corn heads. Replaces 71359125.



Order No	List
S62-0726	19.10

**GATHERING CHAIN IDLER SPROCKET**

Lower idler sprocket, regreasable, 8 tooth, 5/8" hole. For all huggor corn heads. Replaces 71359125.



Order No	List
S62-0815	33.04

**1-YEAR WARRANTY ON ALL ITEMS!**

# BLACKWELDER

HERSCHEL sections are made in the USA from high quality boron steel. Heat-treated for long life. Sections are extra heavy (.116") and chrome unless stated otherwise.

## SECTION TYPES

7TS = Super 7® Top Serrated      TT = Tiger Tooth  
SM = Smooth                              TJ = Tiger Jaw  
US = Under Serrated - 14 Tooth      SRK = Tiger Shark™  
TS = Top Serrated - 14 Tooth



### SECTION - XHSM

Fits BLACKWELDER **Tomato Harvesters**. Bottom countersunk. Section is 3" x 3-1/4". Uses 5/8 OH rivet. Sold 10 sections per pack.

#### Replaces

Number	Order No	List
49152	S20-1152	16.36

# CEREAL (CCIL)



### SECTION - XHUS

Fits Cereal **Swathers**. Section is 3" x 3-1/4". Uses 1/2 OH rivet. Sold 10 sections per pack.

#### Replaces

Number	Order No	List
1145	S20-5107	10.58

<b>B</b>		<b>P</b>	
Bale Counter.....	12	Pick-Up Teeth .....	19
Bearings, Plastic Reel .....	19	Plastic Reel Bearings .....	19
Board, Grass .....	12	Plastic Tines .....	19
Bolt-N-Clip Kit.....	12	<b>R</b>	
Bolts, Section.....	12	Rake Teeth .....	20
<b>C</b>		Reel Tines .....	19
Chains, Gathering.....	20	Rivets, Section.....	12
Clips, Hold Down .....	18	<b>S</b>	
Combine Teeth .....	19	Sections.....	10 - 11
<b>D</b>		Section Bolts.....	12
Disc Mower Knives .....	17	Section Rivets.....	12
<b>E</b>		Sickle Heads.....	16
End Sections .....	11	Sickles .....	13 - 15
<b>G</b>		Spliced Sickles .....	15
Gathering Chain .....	20	Spring Teeth .....	20
Gathering Chain Sprockets .....	20	Sprockets, Gathering Chain .....	20
Grass Board .....	12	<b>T</b>	
Guards, Case I.H.....	17 - 18	Teeth, Combine .....	19
<b>H</b>		Teeth, Pick-up.....	19
Hammer Rivet Tool .....	20	Teeth, Rake .....	19
Head Socket Assemblies.....	16	Teeth, Reel .....	19
Hold Down Clips .....	18	Teeth, Spring .....	20
<b>K</b>		Tines, Reel .....	19
Kit, Bolt-N-Clip.....	12	Tooth, Rake .....	20
Kits, Combine Cutterbar Replacement.....	16	<b>W</b>	
Kits, Spliced.....	16	Wear Plate.....	19
<b>O</b>			
Overlap Sections .....	10		

# CASE-IH

HERSCHEL sections are made in the USA from high quality boron steel. Heat-treated for long life. Sections are extra heavy (.116") and chrome unless stated otherwise.

All Case-IH sections have 2-1/16 hole spacing.

## SECTION TYPES

7TS = Super 7<sup>®</sup> Top Serrated      TT = Tiger Tooth  
 SM = Smooth                              TJ = Tiger Jaw  
 US = Under Serrated - 14 Tooth      SRK = Tiger Shark™  
 TS = Top Serrated - 14 Tooth



### SECTION - XHTSCR - B TYPE

Fits all CASE mowers and windrowers. Section is 3 x 3-1/4. Uses 1/2 OH rivet. Sold 10 sections per pack. Replaces 049213.

Order No.      List  
 S20-4277      15.39



### SECTION - XH7TSCR - H+ TYPE

Fits HART-CARTER Floating Bar. Section is 3 x 2-1/2. Uses 5/8 CS rivet. Sold 10 sections per pack. Replaces OEM 277444. Bottom countersunk.

Order No.      List  
 S20-4322      17.46



### SECTION - XHTSCR - H TYPE

Fits HART-CARTER Floating Bar (soybean) Series 1 & 2. Section is 3 x 2-1/2. Uses 5/8 CS rivet. Sold 10 sections per pack. Replaces OEM 179736C3. Bottom countersunk.

Order No.      List  
 S20-4462      18.81



### SECTION - XHTSCR

Fits all CASE-IH combines 810 rigid header. Section is 3 x 2-31/32. Uses 9/16 OH rivet. Sold 10 sections per pack. Replaces 634794R2.

Order No.      List  
 S20-4681      17.84



### OVERLAP SECTIONS

Fits all CASE-IH double drive sickle overlap. Section is 3 x 3-1/4. Uses 9/16 OH rivet. Sold 10 sections per pack. Replaces TS635161. Bottom countersunk

Description	Design	Order No	List
XH7TSCR	B+	S20-4309	17.32
XHTSCR	B	S20-4371	23.65



### SECTIONS - HTS

Fits all CASE-IH mowers, windrowers and mower conditioners. .083 Thick. Section is 3 x 3-1/4. Uses 1/2 OH rivet or B55-0065D bolt. Sold 10 sections per pack. Replaces MC333

Order No.      List  
 S20-3412      14.88



### HALF SECTION - SMOOTH

One used on head end. Sold 10 sections per pack.

Order No.      List  
 S20-0297      21.74

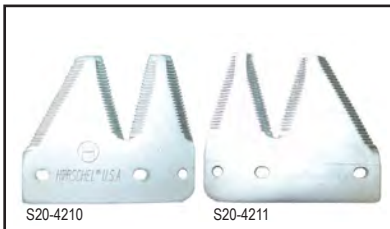

### END SECTION - XHTSCR

Uses 9/16 OH rivet. Sold 10 sections per pack.

Application	OEM #	Order No	List
RH	700705462	S20-4210	38.49
LH	700705463	S20-4211	38.49

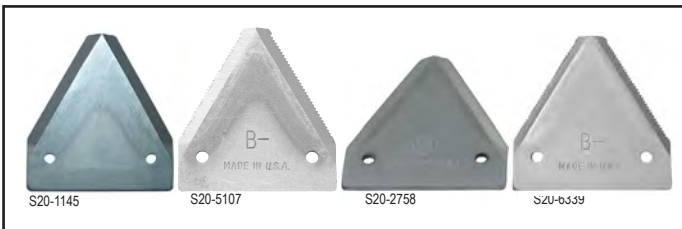

### SECTIONS

Fits all CASE-IH mowers, windrowers and mower conditioners. Section is 3 x 3-1/4. Uses 9/16 OH rivet. Sold 10 sections per pack.

OEM #	Description	Design	Order No	List
826724C1	XHSM		S20-1145	12.58
826722C2	XHUS	B-	S20-5107	10.58
A457605R2	XHSMCR		S20-2758	20.44
457607R3	XHUSCR	B-	S20-6339	13.30

**1-YEAR WARRANTY ON ALL ITEMS!**



**WHY TRY TIGER SHARK™ SECTIONS?**

1. Serrated teeth allow more cutting surface.
2. They last longer, cut faster.
3. Cuts equally well in soybeans, alfalfa, grass hay, wheat, etc.

**Customer Testimonial:**

I cut over 1000 acres of soybeans with the same *Herschel Tiger Shark™* sections. They stayed sharper longer and lasted longer than any section I have used. - Roger Woodruff, Warren Co. Iowa

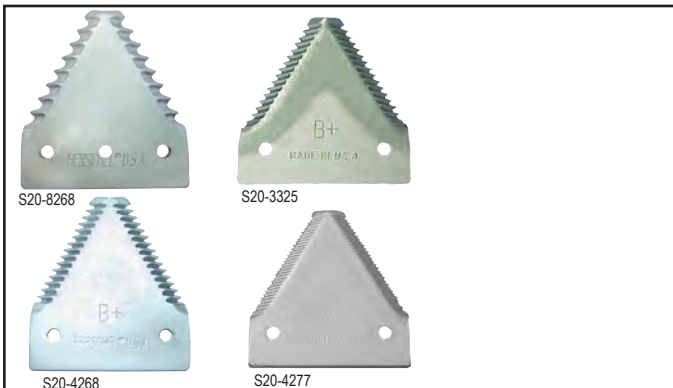

**SECTIONS**

Fits CASE-IH mowers and conditioners 820, 1010, 1020, 2010, 2020 combine headers. Section is 3 x 3-1/4. Uses 9/16 OH rivet. Sold 10 sections per pack.

The *Tiger Shark™* section can be used in place of the sections listed below.

OEM #	Description	Design	10 Pack Order No	List	25 Pack Order No	List
	<i>Tiger Shark™</i>	3-Hole	S20-8268	13.37	S20-8268P	31.70
826720C2, 9622744, 86615988	XHTS	B	S20-3276	10.59	S20-3276P	25.16
112074A1, 86616588, 86616691	XH7TS	B+	S20-3325	10.54	S20-3325P	25.13
191256A1, 86616689	XH7TSCR	B+	S20-4268	12.75	S20-4268P	30.49
700705300, 86616527	XHTSCR	B	S20-4277	15.39	S20-4277	36.66
826720C2, 112074A1	XH7TS, 3 hole	B+	S20-3482	14.54		



**SECTIONS**

Fits CASE-IH Combine Heads 1042, 1052, 2042, 2052, 2062, 2142, 2152, 2162. Section is 3 x 3-1/4. Sold 10 sections per pack.

The *Tiger Shark™* section can be used in place of the sections listed below.

OEM #	Description	Design	10 Pack Order No	List	25 Pack Order No	List
	<i>Tiger Shark™</i>	C+	S20-8398	14.81	S20-8398P	35.16
87422066	XH7TSCR	C+	S20-4398	14.10	S20-4398P	33.37
1327448C1	XHTS	C	S20-3283	12.91	S20-3283P	30.88
84342590	XHTSCR	C	S20-4170	16.91		



**SECTIONS**

Fits Case-IH 3020, 3152, 3162, NH740CH, NH8800CF Combine Headers. Section is 3 x 3-1/4. Sold 10 sections per pack.

The *Tiger Shark™* section can be used in place of the section listed below.

OEM #	Description	Design	Order No	List
	<i>Tiger Shark™</i>		S20-8549	12.92
87728905	XH7TS	C+	S20-3549	12.29



**TIGER JAW SECTIONS**

Fits all Case-IH Combines with Tiger Jaw systems. Section is 3 x 3-1/4. Uses B55-0065D bolt. Sold 10 sections per pack.

Replaces Number	Description	Reference Number	Order No	List
TJ7000	XHTJCR	R	S20-4639	17.63
SSTJ7000	XH7TJCR	R+	S20-4317	17.62



**IH - 1-1/2" SYSTEM**

Fits all Case-IH Combine 1020 with 1-1/2" IH systems. Section is 3 x 3. Uses B55-0050D bolt, B55-0060D Head bolt. Sold 10 sections per pack.

Replaces Number	Order No	List
1970390C2	S20-3120	19.22

**Our Agricultural Background - Cutting Parts**

Founded in 1887, by two brothers, Paul E and H. Robert Herschel. R. Herschel Manufacturing quickly became a leader in the sickle section industry.

For more than 130 years HERSCHEL has been an innovator in the cutting parts industry and introduced the chrome plated section (1950), Tiger Jaw® (1981) and Tiger Jaw 2000® (1997) combine conversion kits, Super 7® sections (1992) and most recently the Tiger Shark™ section (2016). Cutting parts designed to provide the agricultural industry with a high quality product at an exceptional value. We are proud to still make our popular cutting products at our factory in Indianola, IA.

**UNIVERSAL END SECTIONS**

HERSCHEL End Sections are made of one-piece high carbon, heat-treated steel for rugged use. They are punched with an oblong hole to virtually fit any standard cutterbar mower in use today. To install our End Section, simply take off the last section on the shoe end of your sickle assembly and replace it with an End Section. The change-over takes only a couple of minutes to complete and you will notice a big difference in time saved from unclogging your mower. We recommend using R36-0523D oval head rivets or B55-0065D Bolts.



Description	Order No	List	Description	Order No	List
XH7TSCR (RH) 10/Box	S20-4403	38.49	<i>Tiger Shark™ (LH) 2/SP</i>	S20-8445D	12.06
XH7TSCR (RH) 2/SP	S20-4403D	10.54	XHTS CR (RH) 10/Box	S20-4210	38.49
<i>Tiger Shark™ (RH) 10/Box</i>	S20-8403	45.13	XHTS CR (RH) 2/SP	S20-4210D	10.54
<i>Tiger Shark™ (RH) 2/SP</i>	S20-8403D	12.06	XHTSCR (LH) 10/Box	S20-4211	38.49
XH7TSCR (LH) 10/Box	S20-4445	41.22	XHTSCR (LH) 2/SP	S20-4211D	10.54
XH7TSCR (LH) 2/SP	S20-4445D	13.94	XHUSCR (RH) 10/Box	S20-6640	40.77
<i>Tiger Shark™ (LH) 10/Box</i>	S20-8445	45.13	XHUSCR (RH) 2/SP	S20-6640D	10.54

S20-8445



## SECTION BOLTS

- Quick and easy section changes are possible with bolts.
- No more cutting, chiseling, or grinding - simply unbolt the section, replace and tighten bolts.
- Bolts will not turn in Knife Back and are reusable. They will last thru the life of several sections.
- Bolts may be replaced easily if accidentally damaged or broken.
- No special tools are needed to change sections, only a 7/16 wrench or socket.
- Bolt and nuts hold better than rivets and they have a greater clamp load than rivets.
- Special lock nuts will not vibrate loose.

Description	Application	Qty. Pkg.	Mst Ctn.	Order No	List
Section Bolt w/nut	Universal - Replaces 9/16 & 5/8 OH Rivets	50	300	B55-0065D	9.55
Head Bolt w/nut	Universal - Replaces 1-1/2 & 1-1/16 OH Rivets	15	90	B55-0085D	5.85
Head Bolt w/nut	Universal - Replaces 1-1/2 OH Rivets	12	72	B55-0095D	6.02
Section Bolt w/nut	Case I-H Combines 1010 & 1020, 1-1/2 System**. Oval Head.	20	120	B55-0050D	18.56
Head Bolt w/nut	Case I-H Combines 1010 & 1020, 1-1/2 System**. Oval Head. 1-1/8	16	96	B55-0060D	25.89
Section Bolt w/nut	Universal Bolts for 10' Sickle w/Head Bolts (80-B55-0065D, 5-B55-0085D, 5-B55-0095)	90	Each	B55-0500D	22.76
Overlap Bolt w/Low Profile Nut*	Double Drive Sickles, replaces 1/2 CS rivets 60° Head	10	60	B55-0059D	7.06
Section Bolt*	Versatile, Countersink, replaces 9/16 CS rivets	20	120	B55-0056D	10.82
Section Bolt*	Love & Hart Carter, Countersink, replaces 5/8 CS rivets. 60° Head	20	120	B55-0057D	5.05
Head Bolt*	Love, Hart Carter & Versatile, Countersink, replaces 1 CS rivets	10	6	B55-0058D	8.56
Nut	Universal-Used on all the above bolts except B55-0050D	20	120	N83-0289D	5.36

\* Use with Allen Wrench

\*\* Requires IH Hold Down OEM#132074663



## OVERLAP SECTION KIT

For Case-IH 8380 and 8840. Contains: (5) S20-4371 - XH TS CR Sections, (3 RH & 2 LH) Btm. CTSK Sections, (10) B55-0059 - CTSK Bolts & Nuts.

Order No	List
S20-4003	23.14

## SECTION RIVETS - ZINC PLATED

OH = Oval Head CS = Counter Sunk

Size/No. in Pkg.	Application	Qty. Pkg.	Mstr. Ctn.	Order No	List
5/8 # 5-1/2 (56)	7' Heavy Mower Sections and Knife Heads	Asst.	6	R36-0523D	7.75
1 # 5-1/2 (10)	Mower Conditioners	Asst.	6	R36-0524D	9.39
5/8 # 5-1/2 (72)					
1 # 5-1/2 (5)					
1-1/4 # 5-1/2 (5)					
5/8 OH #5-1/2	Heavy Gauge Sections	1#	6#	R36-0462D	13.40
15/16 OH #5-1/2	Head Rivet	1/2#	3#	R36-0522D	6.32
1-1/4 OH #5-1/2	Head Rivet	1/2#	3#	R36-0467D	6.83
5/8 CS #5-1/2	Section Rivet	1#	6#	R36-0463D	10.94
1-1/4 CS #5-1/2	Guard Plate Rivet	1/2#	3#	R36-0468D	6.63



## SECTION CLIP

For Case-IH 2142, 2152, 2162 Double Drive Head. Fits 42, 52, 62 Series Headers. Replaces 87458207. 20 per pack.

Order No	List
C45-0050	17.21

## GRASS BOARD

Fits all mowers.



Order No	List
B52-0615	44.40

## BOLT-N-CLIP KIT

**Why bolts are better than rivets:**

- Bolts will not turn in Knife Back and are reusable.
- They will last thru the life of several sections.
- Bolts may be replaced easily if accidentally damaged or broken.
- No special tools are needed to change sections, only a 7/16 wrench or socket.
- Bolts and nuts hold better than rivets. They have a greater clamp load than rivets.

Fits most mowers, mower conditioners and combines. For 10' bar. Includes 9 Low Arch Clips, 1 High Arch Clip, Bolts & Nuts to do a 10' Bar

Order No	List
B55-0629	40.16



## BALE COUNTER

Bale counter, reads up to 99,999. 4-hole mounting plate, push button reset, adjustable side arm. Fits most balers.



Order No	List
T55-0002	25.30

## Our Agricultural Background - Tillage Products

Did you know that we are also a leader in the tillage parts industry?

In 1995, Herschel Manufacturing decided to expand their tillage market and made the decision to purchase ADAMS Hard-Facing. Adams Hard-Facing was founded in 1927 by W.E. Adams and was known for long wearing, high quality hard-faced and plain tillage tool parts. The addition of these unique and high quality parts to the product line has enhanced our industry-leading position in tillage. We have proudly continued to make high quality tillage tools like our Terminator Sweeps at our factory in Indianola, IA.

**1-YEAR WARRANTY ON ALL ITEMS!**

**CASE RIVETED SICKLE ASSEMBLIES**

**MOWER CONDITIONER 555**

OEM #	Length	No. Of Sections	Head	Head OEM #	Type	Section	Section OEM #	Riveted Order No	Riveted List	Bolted Order No	List
451955HD	9'	38	H15-0880	451948HD	XHTSCR	S20-4277	049213	S35-4594	170.90	-	-
6566178HD	9'	38	H15-0880	451948HD	XHTSCR	S20-4564	049254	S35-4060	171.51	-	-

**WINDROWERS 950, 955, 1050, 1055, 1150, 1155**

OEM #	Length	No. Of Sections	Head	Head OEM #	Type	Section	Section OEM #	Riveted Order No	Riveted List	Bolted Order No	List
6566178HD	9'	38	H15-0880	451948HD	XHTSCR	S20-4564	049254	-	-	S35-2359	189.00

**CASE IH SICKLES**

**MOWER SERIES 100 BALANCED HEAD 1000 SERIES, 1100, 1300 PIN TYPE**

OEM #	Length	No. Of Sections	Head	Head OEM #	Type	Section	Section OEM #	Riveted Order No	Riveted List	Bolted Order No	List
462381R93	7'	28	H15-0281	56692C91	XHSM	S20-1145	826724C1	S35-3668	151.23	-	-
					<b>Tiger Shark™</b>	<b>S20-8268</b>				<b>S35-2500</b>	<b>151.06</b>
462380R93	7'	28	H15-0281	56692C91	XHUS	S20-5107	826722C1, 826722C2	S35-3667	110.63	S35-1281	173.36
SS1281292C92	7'	28	H15-0281	56692C91	XH7TS	S20-3325	112074A1	-	-	S35-1032	190.65
1281292C92	7'	28	H15-0281	56692C91	XHTS	S20-3276	826720C2	S35-3939	172.86	-	-
1281291C92	9'	35	H15-0281	56692C91	XHTS	S20-3276	826720C2	S35-3940	117.60	S35-1103	164.52
463182R93	9'	35	H15-0281	56692C91	XHSM	S20-1145	826724C1	S35-3672	136.64	-	-
463159R93	9'	35	H15-0281	56692C91	XHUS	S20-5107	826722C1, 826722C2	S35-3669	115.53	S35-1714	158.40
					<b>Tiger Shark™</b>	<b>S20-8268</b>				<b>S35-2512</b>	<b>149.54</b>
SS1281291C92	9'	35	H15-0281	56692C91	XH7TS	S20-3325	112074A1	S35-3012	111.07	S35-1033	136.70

**ALL MOWER MODELS EXCEPT SERIES 100 BALANCED HEAD (OLD BALL HEAD)**

OEM #	Length	No. Of Sections	Head	Head OEM #	Type	Section	Section OEM #	Riveted Order No	Riveted List	Bolted Order No	List
1958206C1	6'	24	H15-0257	MA999	XHUS	S20-5107	826722C1, 826722C2	S35-3629	116.39	-	-
<b>1958205C1</b>	<b>7'</b>	<b>28</b>	<b>H15-0257</b>	<b>MA999</b>	<b>Tiger Shark™</b>	<b>S20-8268</b>				<b>S35-1131</b>	<b>143.63</b>
1958207C1	7'	28	H15-0257	MA999	XHUS	S20-5107	826722C1, 826722C2	S35-3630	115.90	S35-1282	169.61
SS1958207C1	7'	28	H15-0257	MA999	XH7TS	S20-3325	112074A1	S35-3631	134.99	S35-1031	138.11
1958203C1, MB409	7'	28	H15-0257	MA999	XHSM	S20-1145	826724C1	S35-3543	120.57	-	-
463294R91	9'	36	H15-0257	MA999	XHUS	S20-5107	826722C1, 826722C2	S35-3304	224.09	-	-
1958206C1	6'	24	H15-0257	MA999	XHSM	S20-1145	826724C9	S35-3542	123.72	-	-
SS463294R51	9'	36	H15-0257	MA999	XH7TS	S20-3325	112074A1	S35-1097	215.82	-	-

**MOWER CONDITIONER 990**

OEM #	Length	No. Of Sections	Head	Head OEM #	Type	Section	Section OEM #	Riveted Order No	Riveted List	Bolted Order No	List
542816R91, 542816R92	7'	28	H15-0131	540607R11	XHUS	S20-5107	826722C1, 826722C2	S35-3132	167.64	-	-
540605R91, 540605R92	9'	36	H15-0131	540607R11	XHUS	S20-5107	826722C1, 826722C2	S35-3133	137.97	S35-1715	231.35
					<b>Tiger Shark™</b>	<b>S20-8268</b>				<b>S35-2559</b>	<b>221.30</b>

**WINDROWERS 75 PULL TYPE**

OEM #	Length	No. Of Sections	Head	Head OEM #	Type	Section	Section OEM #	Riveted Order No	Riveted List	Bolted Order No	List
825821C91	21'	84	Headless	-	XHTSCR	S20-4277	596321R3	-	-	S35-2288	357.77

**MOWER 1190**

OEM #	Length	No. Of Sections	Head	Head OEM #	Type	Section	Section OEM #	Riveted Order No	Riveted List	Bolted Order No	List
101987C95	7'	29	H15-0283	824594C91	XHUS	S20-5107	826722C1, 826722C2	S35-3293	282.48	-	-
101988C95	9'	37	H15-0283	824594C91	XHUS	S20-5107	826722C1, 826722C2	S35-3292	195.16	S35-1716	231.70
					<b>Tiger Shark™</b>	<b>S20-8268</b>				<b>S35-2514</b>	<b>201.05</b>

## WINDROWERS 230, 4000, 5000 ALL WITH SINGLE AUGER OR DRAPER HEADER, 210 S/N 3700-LATER

OEM #	Length	No. Of Sections	Head	Head OEM #	Type	Section	Section OEM #	Riveted Order No	Riveted List	Bolted Order No	List
827814C92	14.5'	57	H15-0283	824594C91	XHUSCR	S20-6339	457607R3	S35-4289	422.29	S35-2717	452.20
831607C94	14.5'	57	H15-0283	824594C91	XHTSCR	S20-4277	596321R3	-	-	S35-2295	359.98
827815C92	16.5'	64	H15-0283	824594C91	XHUSCR	S20-6339	457607R3	S35-4290	381.91	-	-
1281480C92	16.5'	64	H15-0283	824594C91	XHTSCR	S20-4277	596321R3	-	-	S35-2296	418.89
827816C92	19.5'	76	H15-0283	824594C91	XHUSCR	S20-6339	457607R3	S35-4291	452.41	-	-
1281481C92	19.5'	76	H15-0283	824594C91	XHTSCR	S20-4277	596321R3	-	-	S35-2297	420.66

## WINDROWERS 4000, 5000, 5500 ALL WITH DUAL AUGER HEADER

OEM #	Length	No. Of Sections	Head	Head OEM #	Type	Section	Section OEM #	Riveted Order No	Riveted List	Bolted Order No	List
827701C92	14'	56	H15-0283	824594C91	XHTSCR	S20-4277	596321R3	-	-	S35-2587	407.52

## WINDROWERS 6500, 7000 WITH SINGLE DRIVE AUGER HEADER

OEM #	Length	No. Of Sections	Head	Head OEM #	Type	Section	Section OEM #	Riveted Order No	Riveted List	Bolted Order No	List
33704	18'	71	Headless	-	XH7TSCR	S20-4398	SS34390CR	-	-	S35-2262	354.08
43074	21'	83	Headless	-	XH7TSCR	S20-4398	SS34390CR	-	-	S35-2253	351.47
338616A1											
43076	4'	16	Headless	-	XH7TSCR	S20-4398	SS34390CR	-	-	S35-2254	182.37
43077	9'	36	Headless	-	XH7TSCR	S20-4398	SS34390CR	-	-	S35-2255	263.55

## WINDROWERS 8820 SINGLE AUGER HEADER

OEM #	Length	No. Of Sections	Head	Head OEM #	Type	Section	Section OEM #	Riveted Order No	Riveted List	Bolted Order No	List
700709577	7' LH	25	H15-0390	6821078	XHTSCR	S20-4564	700705300	S35-4390	275.74	-	-
700709578	7' RH	25	H15-0301	6821136	XHHTSCR	S20-4564	700705300	S35-4391	275.74	-	-
700709579	8' LH	29	H15-0390	6821078	XHTSCR	S20-4564	700705300	S35-4388	290.97	-	-
700709580	8' RH	29	H15-0301	6821136	XHTSCR	S20-4564	700705300	S35-4389	290.97	-	-

## MOWER, MOWER/CONDITIONER 1490, 1590

OEM #	Length	No. Of Sections	Head	Head OEM #	Type	Section	Section OEM #	Riveted Order No	Riveted List	Bolted Order No	List
143806C92, ZA502889	12'	49	H15-0292	ZA502562	XHUSCR	S20-6339	457607R3	-	-	S35-2293	344.71
143807C92, ZA502890	14'	57	H15-0292	ZA502562	XHUSCR	S20-6339	457607R3	-	-	S35-2294	358.48

## MOWER/CONDITIONER 8380, 8840, 8870 WITH 625 AUGER HEADER, SC414DLX, SC416DLX

OEM #	Length	No. Of Sections	Head	Head OEM #	Type	Section	Section OEM #	Riveted Order No	Riveted List	Bolted Order No	List
SS700114590	7' LH	28	H15-0063	700114594	XH7TSCR	S20-4268	700705300	-	-	S35-2001	206.68
SS700709581	7' LH	28	Headless	-	XH7TSCR	S20-4268	700705300	-	-	S35-2003	133.52
SS700114591	7' RH	28	H15-0063	700114594	XH7TSCR	S20-4268	700705300	-	-	S35-2002	210.39
SS700709582	7' RH	28	Headless	-	XH7TSCR	S20-4268	700705300	-	-	S35-2004	133.52
700715165	7' LH	28	H15-0063	700114594	XHTSCR	S20-4277	700705300	-	-	S35-2067	281.68
700715166	7' RH	28	H15-0063	700114594	XHTSCR	S20-4277	700705300	-	-	S35-2068	281.68
SS700114592	8' LH	32	H15-0063	700114594	XH7TSCR	S20-4268	700705300	-	-	S35-2014	224.86
										S35-2528	218.57
SS700709585	8' LH	32	Headless	-	XH7TSCR	S20-4268	700705300	-	-	S35-2017	166.93
SS700114593	8' RH	32	H15-0063	700114594	XH7TSCR	S20-4268	700705300	-	-	S35-2015	224.86
										S35-2532	211.08
SS700709586	8' RH	32	Headless	-	XH7TSCR	S20-4268	700705300	-	-	S35-2016	166.93
700715167	8' LH	32	H15-0063	700114594	XHTSCR	S20-4277	700705300	-	-	S35-2069	263.78
700114894	8' LH	32	Headless	-	XHTSCR	S20-4277	700705300	-	-	S35-2111	249.26
700715168	8' RH	32	H15-0063	700114594	XHTSCR	S20-4277	700705300	-	-	S35-2070	263.78
700715168	8' RH	32	Headless	-	XHTSCR	S20-4277	700705300	-	-	S35-2112	249.26
SS700715778	9' LH	36	H15-0063	700114594	XH7TSCR	S20-4268	700705300	-	-	S35-2305	316.80
SS700715778	9' LH	36	Headless	-	XH7TSCR	S20-4268	700705300	-	-	S35-2306	215.99
SS700715779	9' RH	37	H15-0063	700114594	XH7TSCR	S20-4268	700705300	-	-	S35-2309	316.54
700715778	9' LH	36	H15-0063	700114594	XHTSCR	S20-4277	700705300	-	-	S35-2307	342.80
700715778	9' LH	36	Headless	-	XHTSCR	S20-4277	700705300	-	-	S35-2308	191.76
700715779	9' RH	37	H15-0063	700114594	XHTSCR	S20-4277	700705300	-	-	S35-2311	380.92
700715779	9' RH	37	Headless	-	XHTSCR	S20-4277	700705300	-	-	S35-2312	194.76



**MOWER/CONDITIONER 8380, 8840, 8870 WITH 625 AUGER HEADER**

OEM #	Length	No. Of Sections	Head	Head OEM #	Type	Section	Section OEM #	Riveted Order No	Riveted List	Bolted Order No	List
700114590	7' LH	28	H15-0063	700114594	Tiger Shark™	S20-8268		-		S35-2517	206.68
700114591	7' RH	28	H15-0063	700114594	Tiger Shark™	S20-8268		-		S35-2519	206.27

**MOWER/CONDITIONER 8340**

OEM #	Length	No. Of Sections	Head	Head OEM #	Type	Section	Section OEM #	Riveted Order No	Riveted List	Bolted Order No	List
700118673	9'	37	H15-0066	700111003	XHTSCR	S20-4277	596321R3	-		S35-2071	272.48

**MOWER/CONDITIONER 8360, 8370, 8830, SC412, SC414 CENTER PIVOT WITH 425 HEADER**

OEM #	Length	No. Of Sections	Head	Head OEM #	Type	Section	Section OEM #	Riveted Order No	Riveted List	Bolted Order No	List
700110730, 700709622	12'	48	H15-0066	700111003	XHTSCR	S20-4277	596321R3	-		S35-2072	298.85
700110731, 700709623	14'	56	H15-0066	700111003	XHTSCR	S20-4277	596321R3	-		S35-2073	326.63

**MOWER/CONDITIONER 8320, 8330, 8350**

OEM #	Length	No. Of Sections	Head	Head OEM #	Type	Section	Section OEM #	Riveted Order No	Riveted List	Bolted Order No	List
700709587, 700712775	7'	29	H15-0390	6821078	XHTSCR	S20-4277	596321R3	-		S35-2080	339.75
700111430, 700711767	9'	37	H15-0390	6821078	XH7TSCR	S20-4268	SS596321R3	-		S35-2081	215.26
700109341, 700709583	12'	48	H15-0390	6821078	XH7TSCR	S20-4268	SS596321R3	-		S35-2082	308.81

**810 FLOATING BAR WOBBLE HEAD S/N 26001-LATER, GENERATION III HART-CARTER**

OEM #	Length	No. Of Sections	Head	Head OEM #	Type	Section	Section OEM #	Riveted Order No	Riveted List	Bolted Order No	List
180853C91	13'	53	H15-0194	180859C91	XHTSCR	S20-4462	179736C3	S35-4230	333.90	-	

**COMBINE 820 HEADER - 3 CUT**

OEM #	Length	No. Of Sections	Head	Head OEM #	Type	Section	Section OEM #	Riveted Order No	Riveted List	Bolted Order No	List
197463C91, 197463C93	15'	58	H15-0640	197230C91	XHTS	S20-3276	826720C2	-		S35-2115	424.45
197466C91, 197466C93	20'	78	H15-0640	197230C91	XHTS	S20-3276	826720C2	-		S35-2117	472.09

**ALL MOWERS MA 999 HEADER & BALANCED HEAD, 990, 1190 M/C**

OEM #	Length	No. Of Sections	Head	Head OEM #	Type	Section	Section OEM #	Riveted Order No	Riveted List	Bolted Order No	List
			Headless					-		S35-1038	94.93
			Headless					-		S35-1039	111.45

**2142, 2152 RIGID DRAPER HEAD**

For 30'

OEM #	Length	No. Of Sections	Head	Head OEM #	Type	Section	Section OEM #	Riveted Order No	Riveted List	Bolted Order No	List
124926	16' RH	35	Headless	-	XH7TSCR	S20-4398	SS34390CR			S35-2120	166.93
124923	16' LH	31	Headless	-	XH7TSCR	S20-4398	SS34390CR			S35-2121	166.93

**2162 DOUBLE DRIVE GRAIN HEAD**

For 30'

OEM #	Length	No. Of Sections	Head	Head OEM #	Type	Section	Section OEM #	Riveted Order No	Riveted List	Bolted Order No	List
	20.5' LH	81	Headless	-	XH7TSCR	S20-4398	SS34390CR			S35-2130	386.75

**COMPLETE SPLICED SICKLES - HEADLESS XH7TS SECTIONS**  
Fits Case-IH 1010, 1020 HEADER 3 CUT

Section part number is S20-3325, OEM# 112074A1.

- A = 7' Head End S35-1044
- B = 7.25' Head End S35-1043
- C = 7.5' S35-1042
- D = 5' S35-1041

OEM #	Length	# of Sections	A	B	C	D	XH7TS Order No	List	Tiger Shark Order No	List	14-Tooth Order No	List
1307283C98	20'	78	-	1	1	1	S35-1052	245.57	S35-2786	311.84		
1307284C98	22.5'	88	-	1	2	-	S35-1051	265.61	S35-2787	301.96		
1307255C98	25'	98	-	1	1	2	S35-1050	394.95	S35-2774	377.79	S35-2770	394.95
1307286C98	30'	118	-	1	3	-	S35-1049	458.77	S35-2775	438.84	S35-2771	458.77

**COMPLETE SPLICED SICKLES - HEADLESS XH7TS SECTIONS**  
Fits Case-IH 820 HEADER 3 CUT

Section part number is S20-3325, OEM# 112074A1.

- A = 7' Head End S35-1044
- B = 7.25' Head End S35-1043
- C = 7.5' S35-1042
- D = 5' S35-1041

OEM #	Length	# of Sections	A	B	C	D	Order No	List
SPL197463C93	15'	58	1	-	2	-	S35-1048	233.87
SPL197465C93	17.5'	68	1	-	2	-	S35-1047	299.29
SPL197466C93	20'	78	1	-	1	1	S35-1046	328.63

## SPLICE KIT

Splice Kit 2-1/16 hole spacing. Kit Contains 2 straps along with the bolts & nuts.

<b>Order No</b>	<b>List</b>
C83-0755	22.80

Bolts & Nuts for C83-0755 Splice Kit. Contains 12 each per package.

<b>Order No</b>	<b>List</b>
B55-0049D	8.74



## SICKLE BACK

Fits Case-IH SERIES 100 MOWERS



Replaces	Size	Order No	List
IH 7	7'	S35-6096	34.04
IH 9	9'	S35-6095	32.05

## OUTER SHOE PLATE

Fits all Case-IH MOWERS

<b>Replaces</b>	<b>Order No</b>	<b>List</b>
MA330	P44-0617	23.11



## PITMAN WOOD - 33-5/8

Fits all Case-IH MOWERS 9, 10 & BIG 6

<b>Replaces</b>	<b>Order No</b>	<b>List</b>
M1583	P38-0530	27.47



## PITMAN WOOD - 35-11/16

Fits all Case-IH MOWERS SERIES 10, 16, 21, 24, 28

<b>Replaces</b>	<b>Order No</b>	<b>List</b>
M22184	P38-0535	30.48



## PITMAN STRAP - FRONT

Fits all Case-IH MOWERS

<b>Replaces</b>	<b>Order No</b>	<b>List</b>
MA1577	S78-0834	79.20



## PITMAN STRAP - REAR

Fits all AUTOMATIC PITMANS

<b>Replaces</b>	<b>Order No</b>	<b>List</b>
M1578	S78-0835	83.77



## HEAD PIN

Fits Case-IH BALANCE HEAD 100 SERIES MOWERS.

<b>Replaces</b>	<b>Order No</b>	<b>List</b>
458973R	P34-0641B	23.90

## BUSHING

Fits Case-IH HEADS WITH OEM#S 462378R11 & 540607R11, Series 100 balanced head 1100, 1300.

<b>Replaces</b>	<b>Order No</b>	<b>List</b>
458971R1	B82-0367D	8.19

## HEAD BEARING & SNAP RINGS

Fits all IH 810 & 820, HC III; Fits H15-0294 Heads, H15-0295 Heads, H15-0194 Heads, H15-0640 Head.

<b>Replaces</b>	<b>Order No</b>	<b>List</b>
KP12A	B15-0659B	31.33

## SICKLE HEADS



Fits Case-IH Combines Floating Bars; 810 Header Wobble Drive HC Gen III. Replaces 180859C91.

<b>Order No</b>	<b>List</b>
H15-0194	118.02



Fits Case-IH Mowers All Except Balanced Head series 100. Replaces MA999.

<b>Order No</b>	<b>List</b>
H15-0257	73.67



Fits Case-IH Mowers w/ Balanced Head Series 100. Replaces 462378R11 and 56692C91.

<b>Order No</b>	<b>List</b>
H15-0281	49.38



Fits Case-IH Mower/Cond. 990. Replaces 462378R11 and 540607C91.

<b>Order No</b>	<b>List</b>
H15-0131	69.18

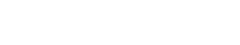

Fits Case-IH Combine 810 Header Not Floating Bar. Replaces 178466C91.

<b>Order No</b>	<b>List</b>
H15-0294	108.93



Fits Case-IH Mower/Conditioner and Windrower 1190, 230, 4000 and 5000. Replaces 824594C91 and 824812C91.

<b>Order No</b>	<b>List</b>
H15-0257	73.67



Fits Case-IH Mower/Cond. 1490, 1590. Replaces ZA502562.

<b>Order No</b>	<b>List</b>
H15-0292	95.62



Fits Case-IH Combine 1010 & 1020 w/3 System or Tiger Jaw Systems. Replaces 1316161C94

<b>Order No</b>	<b>List</b>
H15-0090	104.50

73.67its Case-IH IH 1020 Silver Tiger.

<b>Order No</b>	<b>List</b>
H15-0432	91.18



Fits Case-IH 8340, 8360, 8370 & 8830, Single Drive. Replaces 700111003.

<b>Order No</b>	<b>List</b>
H15-0066	147.65



Fits Case-IH 8380 & 8840, Double Drive Replaces 700114594. Fits both RH and LH sickles.

<b>Order No</b>	<b>List</b>
H15-0063	103.22



Fits Case-IH IH 820 1-1/2 and 3 Cut systems. Tiger Jaw Sickles. Bolted Sickle. Replaces TJ197230C91.

<b>Order No</b>	<b>List</b>
H15-0640	256.00

**1-YEAR WARRANTY  
ON ALL ITEMS!**

**DISC MOWER KNIVES - 13 DEGREE TOP BEVEL**

Fits Case-IH 306, 307, 308, 3204, 3205, 3206, 3309

Length: 4.72      Degree of Twist: 13      Hole Diameter: .73  
Width: 1.86      Thickness: 0.163      Center Of Hole To Back Edge: .78

OEM Number	Style	Shape	Bolt Order No	6 Blades Order No	List	25 Blades Order No	List
ZA526216	5	LH Twisted	B55-0357D	B45-6992D	11.07	B45-6992	41.74
ZA526215	5	RH Twisted	B55-0357D	B45-6993D	11.07	B45-6993	41.74



**FORGED STEEL GUARD**

Fits Case-IH Combines Floating Bar. Replaces 232155-234006, FC 89-2 and HA231.

Order No	List
G81-0125	16.78



**DISC MOWER KNIVES - 13 DEGREE TOP BEVEL**

Fits Case-IH 725, 8309, 8312, 8315, 8850, DC515

Length: 4.21      Degree of Twist: 13      Hole Diameter: .72  
Width: 1.78      Thickness: 0.169      Center Of Hole To Back Edge: .80

OEM Number	Style	Shape	Bolt Order No	6 Blades Order No	List	25 Blades Order No	List
700712888	4	RH Twisted	B55-0344D	B45-6568D	9.83	B45-6568	39.24
700712889	4	LH Twisted	B55-0344D	B45-6569D	9.83	B45-6569	39.24



**FORGED STEEL GUARD**

Fits Case-IH 75 Windrowers. Replaces D8420S K8420S, FS 73-2, HA235.

Order No	List
G81-0070	13.96



Length: 4.21      Degree of Twist: 13      Hole Diameter: .73  
Width: 1.86      Thickness: 0.175      Center Of Hole To Back Edge: .78

OEM Number	Style	Shape	Bolt Order No	6 Blades Order No	List	25 Blades Order No	List
700711857	5	RH Twisted	B55-0342D	B45-6559D	9.39	B45-6559	37.96
700711858	5	LH Twisted	B55-0342D	B45-6560D	9.39	B45-6560	37.96



**FORGED STEEL GUARD**

Fits Case-IH 820, 1010, 1020 Platforms W/ 3 System. (First 3 Guards on LH Drive End). Replaces 483500R3, 1326787C1, FS 85-2, HA210. No wear bar

Order No	List
G81-0183	10.70



**DISC MOWER KNIVES - 18 DEGREE TOP BEVEL**

Fits Case-IH 725, 8850, DC515, 8309, 8312, 8315

Length: 4.21      Degree of Twist: 18      Hole Diameter: .73  
Width: 1.89      Thickness: 0.157      Center Of Hole To Back Edge: .75

OEM Number	Shape	Bolt Order No	6 Blades Order No	List	25 Blades Order No	List
	LHTwisted	B55-0342D	B45-6725D	11.75	B45-6725	40.79
	RHTwisted	B55-0342D	B45-6726D	11.75	B45-6726	40.79

**DISC MOWER KNIVES - 18 DEGREE BOTTOM BEVEL**

Fits Case-IH 725, 8850, DC515, 8309, 8312, 8315

Length: 4.21      Degree of Twist: 18      Hole Diameter: .73  
Width: 1.88      Thickness: 0.163      Center Of Hole To Back Edge: .78

OEM Number	Shape	Bolt Order No	6 Blades Order No	List	25 Blades Order No	List
700715575, 700715576, 86625673, 86625674	LHTwisted	B55-0342D	B45-6572D	10.96	B45-6572	39.90
	RHTwisted	B55-0342D	B45-6573D	10.96	B45-6573	39.90

**DISC MOWER KNIVES - 13 DEGREE TOP BEVEL**

Fits Case-IH 3204, 3205, 3206

Length: 4.76      Degree of Twist: 13      Hole Diameter: .89  
Width: 1.88      Thickness: 0.165      Center Of Hole To Back Edge: .78

OEM Number	Style	Shape	Bolt Order No	6 Blades Order No	List	25 Blades Order No	List
113385A1	5	RH Twisted	B55-0355D	B45-6563D	10.51	B45-6563	41.18
113384A1	5	LH Twisted	B55-0355D	B45-6564D	10.51	B45-6564	41.18



**FORGED STEEL GUARD**

Fits Case-IH M/C 8320, 8330, 8340, 8350, 8360, 8370, 8380, SC412, SC414, SC416. Windrowers 525, 625, 8210, 8220, 8230, 8240, 8820, 8830, 8840, DHX 182, DHX212, DHX252, DXH362, HDX121, HDX122, HDX141, HDX142, HDX161, HDX162, HDX182, SCX100, SMX91, 2010, 2020 Headers prior to s/nCBJ020000. Replaces 86615982, 700707147, DU215, BU215DH, HA200A, FS97-BH. With cross bar.

Order No	List
G81-0155	9.37
G81-0098 - Double Heat Treat	11.23
G81-0231 - Boron	11.23



**DISC MOWER KNIVES - 18 DEGREE TOP BEVEL**

Fits Case-IH 3204, 3205, 3260, 3309

Length: 4.76      Degree of Twist: 18      Hole Diameter: .89  
Width: 1.88      Thickness: 0.165      Center Of Hole To Back Edge: .78

OEM Number	Style	Shape	Bolt Order No	6 Blades Order No	List
527749, 113385A1	5	LH Twisted	B55-0355D	B45-6576D	10.15
527748, 113384A1	5	RH Twisted	B55-0355D	B45-6577D	10.15

**DISC MOWER KNIVES - 13 DEGREE TOP BEVEL**

Fits Case-IH MD72, MD82, MD92, RD132, MDX71, MDX81, MDX91, RD162, DCX91, DCX101, DCX131, DCX161, RDX131, RDX161, RDX181, H7450, H7460, H7550, H7560.

Length: 4.21      Degree of Twist: 13      Hole Diameter: .90  
Width: 1.90      Thickness: 0.160      Center Of Hole To Back Edge: .75

OEM Number	Style	Shape	Bolt Order No	6 Blades Order No	List	25 Blades Order No	List
86621873		LH Twisted	N/A	B45-6721D	10.16	B45-6721	39.58
86621872		RH Twisted	N/A	B45-6720D	10.16	B45-6720	40.79



**FORGED STEEL GUARD**

Fits Case-IH Windrowers 950, 955, 1050, 1055, 1150, 1155, 1275. Replaces 87560324, 87421451. Heat treated. Replaces BU260.

Order No	List
G81-0085	14.40



## FORGED STEEL GUARD

Fits Case-IH 1010, 1020, 2010, 2020 Single & Double Drive Heads s/n CBJ020001 and up. Replaces 1307299C2, 87442324, 334305A1, BU299. With wear bar, no cross bar.

**Order No.**            **List**  
G81-0037            11.03



## FORGED STEEL GUARD

Fits Case-IH Mower/Cond. & Windrowers. Replaces 049312, FS 86-2, HA250. Stub guard.

**Order No.**            **List**  
G81-0120            13.18



## FORGED STEEL GUARD

Fits Case-IH Windrowers. Replaces 823025C1, FT 77-2, HA260. Tie guard

Fits Case Windrowers 950, 955, 1050, 1055, 1150, 1155, 1275. Replaces 049270, FT77-2, BT260, HA260.

**Order No.**            **List**  
G81-0085            14.40



## FORGED STEEL GUARD

Fits Case-IH Combines w/Rigid Bars 810. Replaces 633098R1, FC 69-2, HA265.

**Order No.**            **List**  
G81-0055            18.48



## FORGED STEEL GUARD

Fits Case-IH Combines w/FLOATING BARS. Replaces 179775C1, FC 89-2, HA231.

**Order No.**            **List**  
G81-0125            16.78



## FORGED STEEL GUARD

Fits Case-IH M/C 8320, 8330, 8340, 8350, 8360, 8370, 8380. Windrowers 8210, 8220, 8230, 8240, 8820, 8830. Auger Header 8840. Replaces 1989552C1, 700700845, FS 66-DH, HA245H. Double Heat Treated.

**Order No.**            **List**  
G81-0042            13.92



## FORGED STEEL GUARD

Fits Case-IH Mowers 100, 110, 115 & 115. M/C 1190, 1290, 1490 & 1590. Windrowers 75, 210, 230, 275, 375, 4000, 5000 & 5500. Replaces 613838R2, HA270.

**Order No.**            **List**  
G81-0035            13.05



## FORGED STEEL GUARD

Fits Case-IH 3020, 3152, 3162. Replaces BU973, 87702973.

**Order No.**            **List**  
G81-0973            14.12



## FORGED STEEL GUARD

Fits Case-IH 3020, 3152, 3162. Replaces BU974, 87702974. Head guard. Four used by drive head

**Order No.**            **List**  
G81-0974            14.12



## FORGED STEEL GUARD

Fits Case-IH 2040, 2052, 2062, 2142, 2152, 2162 Draper Head. Replaces HA215M, 87421451.

**Order No.**            **List**  
G81-0097            11.50



## HOLD DOWN CLIPS NON-ADJUSTABLE



Fits all Case-IH Bolted sickles with head clearance. Steel.

Style	Order No.	List
Low Arch	C45-0692	3.57
High Arch	C45-0693	4.79



Fits all Case-IH Windrowers with guard G81-0120. Steel.

Style	Order No.	List
Low Arch	C45-0502	6.59
High Arch	C45-0503	10.03

## HOLD DOWN CLIPS - CASE NON-ADJUSTABLE



Fits CASE Windrowers using guard 049270 (G81-0085). Steel tie plate.

Style	Order No.	List
Low Arch	C45-0500	6.44
High Arch	C45-0501	13.44



Fits all CASE Windrowers using guard 049239 (G81-0040). Steel.

Style	Order No.	List
Low Arch	C45-0692	3.57

## HOLD DOWN CLIPS ADJUSTABLE



Fits Case-IH Mowers, Windrowers, & Swathers. Cast.

Style	Order No.	List
Low Arch	C45-0006	21.39
High Arch	C45-0007	21.39



Fits most Case-IH Combines, Mowers & Windrowers, except Versatile, Hart-Carter & Love. Steel.

Style	Order No.	List
Low Arch	C45-0040	5.65

Fits all Case-IH 1020 Series Platforms with 1-1/2 Systems. Top clip ONLY. Steel

Style	Order No.	List
Top Clip	C45-0011	9.80



Fits all Case-IH 1020 Series Platforms with 1-1/2 Systems. Clip kit. Steel

Style	Order No.	List
Low Arch	C45-0012	9.80

## MALLEABLE GUARDS

Fits 7/16 Bars.

Replaces	Description	Order No.	List
DM700, T27293	Center Guard	G81-0803	7.05
DM700-R	Outer Guard	G81-0805	9.95

Fits all Case-IH Mowers.

Replaces	Description	Order No.	List
MC2041Z	Center Guard	G81-0830	9.66



**Customer Service**

Our customer service department has over 105 years of combined experience in the agricultural industry. Each team member prides themselves on providing each customer the highest level of service and strive to ensure that each customer's needs are met beyond their expectations. From your most difficult product questions to placing an order, our Customer Service Representatives are here for you!

Our customer service representatives can be reached Monday - Friday from 8 am to 4:30 PM CST.

**Give us a call today!**

**WEAR PLATES**



For all Case-IH **Mowers, Swathers, Combines**. Replaces W50. 5-7/8 long. Slotted holes with 3 spacing.

Order No.	List
P44-0591	2.95
P44-0591D*	10.27

\*Display Pack of 2.



For all Case-IH **Mowers**. 6" full length. Replaces MC468.

Order No.	List
P44-0417	2.53



For all Case-IH **Tiger Jaws**. 24" length with 1-1/2 spacing. Heat treated.

Order No.	List
P44-0200	15.14

**1-YEAR WARRANTY ON ALL ITEMS!**



**PLASTIC BEARING KIT**

Includes 6 caps, 6 bases, U-Bolts and 12 nuts.

Application: Reels with Wood Bats used on Case-IH **810, 820**.

Order No.	List
B15-0915	27.47



**PLASTIC BEARING KIT**

Includes 12 bearing halves, 12 bolts, and 12 nuts.

Application: Reels with Tear Drop Bats and Rear Mounted Plastic Tines used on Case-IH **1010, 1020**.

Order No.	List
B15-0920	50.91



**PLASTIC BEARING KIT**

Includes 12 bearing halves, 6 bolts, and 6 nuts.

Application: Pipe Reels with Plastic Tines used on Case-IH **1010, 1020**.

Order No.	List
B15-0925	24.64



**PLASTIC BEARING KIT**

Includes bearing halves, bolts, and nuts.

Application: Case-IH **820, 1020** w/Love Reel.

Order No.	List
B15-0930	24.28

- PATENTED 2 PIECE DESIGN.
- SAVE MONEY! REPLACE ONLY THE TINE.



**HERSCHEL 6 2-PIECE POLY TINES FOR PIPE REELS**

Fits Case-IH 1020 built after 2001 & 2020 series.

Description	Pkg. Qty.	Order No.	List
Tine & Clamp	100/Box	T16-0740	198.88
Tine & Clamp	10/Box	T16-0745	21.80
Tine ONLY	100/Box	T16-0750	130.64



**COMBINE PICKUP REEL**

For Case-IH **Pickup reels**. Replaces H1611. Steel. 100 per box.

Order No.	List
T16-0124	1.60



**NYLON FLEX TINE**

For Case-IH **810 Flex & 820, 1020 1987 & Older**. Replaces N66A. 1 mounts to front of bat. 100 per box.

Order No.	List
T16-0183	189.12



**NYLON FLEX TINE**

For Case-IH **1020 1988 & After**. Replaces 1970586C1 and N67A. 1 mounts to rear of bat. 100 per box.

Order No.	List
T16-0767	165.82



**2 PIECE M/L REEL TINE**

For Case-IH **1020 w/pipe reels built up to 2000. Most combines**. Replaces 782551, 1989438C1, AH136689, AH153175. 100 per box.

Order No.	List
T16-0720	175.64



**2 PIECE M/L REEL TINE**

For Case-IH **1020 w/pipe reels built up to 2000. Most combines**. Replaces 782226, 1989438C1, AH136689, AH153175. 10 per bag.

Order No.	List
T16-0715	19.03



**M/L REEL TINE**

For T16-0715 and T16-0720. No clamps. Replaces HA100MLT. 100 per box.

Order No.	List
T16-0725	128.83

**REPLACEMENT SCREW**

For T16-0715 and T16-0720. No clamps. Replaces HA20SC. 20 per box.

Order No.	List
B55-0096D	2.40



### SPRING TOOTH

For Case-IH Reel 990, 1190. Replaces 540565R. 100 per box.

<u>Order No.</u>	<u>List</u>
T16-0128	3.73



### SPRING TOOTH

For JI CASE Rakes 170, F170, 2000. Replaces R740S.

<u>Order No.</u>	<u>List</u>
T16-0305	3.69



### RAKE SPRING TOOTH

For Case-IH Rakes No. 3, 4, 5, 8, 9, 11, 14, 15, 16, 30, 35, 86, 96, 97. Replaces 462978R1, 457374R1. 100 per box.

<u>Order No.</u>	<u>List</u>
T16-0126	2.36



### RAKE SPRING TOOTH

For Farmhand Rakes. Replaces L2117RH. 50 per box.

<u>Order No.</u>	<u>List</u>
T16-0368	5.35



### GATHERING CHAINS - CA555

For Case-IH 800, 900, 1000 series. Replaces 176279C91. Chain quantity is 40. Attachment link type is C6E, quantity of 8. No offset links. Connection links are endless. Total of 48 links

<u>Order No</u>	<u>List</u>
C30-0121*	33.85

\*Imported



### GATHERING CHAIN

#### DRIVE SPROCKET

For Case-IH 800, 900, 1000 w/Key & Roll Pin Hole. Replaces 199497C1.

<u>Order No</u>	<u>List</u>
S62-0725	18.35



### GATHERING CHAIN

#### ILDER SPROCKET

For Case-IH 800, 900, 1000 series. Replaces 176283C91.

<u>Order No</u>	<u>List</u>
S62-0741	24.18

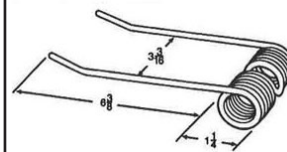

### BALER SPRING TOOTH

For Case-IH 4460, 4650, 4900. Replaces 700706128. 25 per box.

<u>Order No.</u>	<u>List</u>
T16-0163	5.06

### HAMMER RIVET TOOL

For Drive Rivets



<u>Order No.</u>	<u>List</u>
T55-0812	30.72

### DRAPER BELTING

Fits 2152, 2162, 83C, 86C, D60, D65, FD70, FD75

Replaces 220639, 172197, 87560980.

LH & RH Draper Belt w/Single V-Guide Double Delivery

Header Size	Belt Width X Length	QTY Used Per Header	Order No.	List
40'	41.60 x 397.24	2	H87560980	1363.80

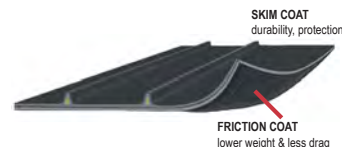

SKIM COAT  
durability, protection

FRICTION COAT  
lower weight & less drag

HERSCHEL sections are made in the USA from high quality boron steel. Heat-treated for long life. Sections are extra heavy (.116") and chrome unless stated otherwise.

### SECTION TYPES

7TS = Super 7® Top Serrated      TT = Tiger Tooth  
 SM = Smooth      TJ = Tiger Jaw  
 US = Under Serrated - 14 Tooth      SRK = Tiger Shark™  
 TS = Top Serrated - 14 Tooth



**SECTION - XHTS**  
 Fits CATERPILLAR Lexion Combines. F series platform. Section is 3" x 3.2". 1/4" bolt holes. 2" spacing. Sold 10 sections per pack.

Replaces Number	Order No	List
149-3303	S20-3478	16.07



**SECTION**  
 Fits CATERPILLAR Lexion Combines. F series platform. Section is 3" x 3.2". 1/4" bolt holes. 2" spacing. Sold 10 sections per pack.

Replaces Number	Type	Order No	List
149-3303	Tiger Shark™	S20-8517	14.10
149-3303	XH7TS	S20-4517	16.25

**FORGED STEEL GUARD**  
 Fits CATERPILLAR-CLAAS Combines. Replaces 676235N, HA207

Order No	List
G81-0198	11.91

**FORGED STEEL GUARD**  
 Fits CATERPILLAR-CLAAS Combines. Double heat treated. Replaces 67629N, HA208H.



Order No	List
G81-0199	14.86

**FORGED STEEL GUARD**  
 Fits CATERPILLAR-CLAAS Combines. Double heat treated. Replaces 67629N, HA208H.



Order No	List
G81-0200	17.22

# FIELD QUEEN



**SECTION - XHUSCR**  
 Fits FIELD QUEEN Hay Harvester 420, 620. Section is 3" x 3-1/4". Use 9/16 OH Rivet. Sold 10 sections per pack.

Replaces Number	Order No	List
457607R2	S20-6339	13.30



**SECTION - XHTSCR**  
 Fits FIELD QUEEN Hay Harvester 420, 620. Section is 3" x 3-1/4". Use 1/2 OH Rivet. Sold 10 sections per pack.

Replaces Number	Order No	List
049213	S20-4277	15.39

**HOLD DOWN CLIPS NON-ADJUSTABLE**



Fits FIELD QUEEN Hay Harvester 420, 620. Steel.

Style	Order No.	List
Low Arch	C45-0692	3.57

**RIVETED SICKLES - HTSCR SECTIONS**  
 Fits FIELD QUEEN Hay Harvester 420, 620.

Section OEM# 049254. Head OEM#: 6193577



OEM #	Length	# of Sections	Order No	List
6272959	12'	49	S35-4881	248.47
6272967	14'	57	S35-4879	304.36

**HOLD DOWN CLIP ADJUSTABLE**



Fits FIELD QUEEN Hay Harvester 420, 620. Stamped

Style	Order No.	List
Low Arch	C45-0040	5.65



Fits FIELD QUEEN Hay Harvester 420, 620. Steel tie plate.

Style	Order No.	List
Low Arch	C45-0500	6.44
High Arch	C45-0501	13.44

**FORGED STEEL GUARD**  
 Fits FIELD QUEEN Windrowers 420, 620. Replaces FS66-2, HA245. Center guard.



Order No	List
G81-0192	9.38

**FORGED STEEL GUARD**  
 Fits FIELD QUEEN Windrowers 420, 620. Replaces 049270, FT-77-2, HA260. Tie guard



Order No	List
G81-0085	14.40

**FORGED STEEL GUARD**  
 Fits FIELD QUEEN Hay Harvesters. Replaces FS65-2.



Order No	List
G81-0035	13.05

# FMC TOMATO HARVESTERS



**SECTION - XHSM**  
 Section is 3" x 3-1/4". Use 5/8 CS rivet. Sold 10 sections per pack.

Replaces Number	Order No	List
5751132	S20-1152	16.36

**5' RIVETED SICKLES - XHSM SECTIONS**

Section OEM# 5751132.



OEM #	# of Sections	Head OEM	Order No	List
5751487-S	20	Less Head	S35-3064	57.35

HERSCHEL sections are made in the USA from high quality boron steel. Heat-treated for long life. Sections are extra heavy (.116") and chrome unless stated otherwise.

## SECTION TYPES

7TS = Super 7® Top Serrated      TT = Tiger Tooth  
 SM = Smooth      TJ = Tiger Jaw  
 US = Under Serrated - 14 Tooth      SRK = Tiger Shark™  
 TS = Top Serrated - 14 Tooth



### SECTION - XHUSCR

Fits GEHL Mower Conditioners 770, 880, 1070, 1090. Section is 3" x 3-3/16". Use 5/8" OH rivet. Sold 10 sections per pack. 2-1/16" hole spacing.

Replaces		
Number	Order No	List
060635	S20-6339	13.30

### 9' 3" RIVETED SICKLE - XHUSCR SECTIONS HEADLESS

Fits GEHL Mower Conditioner 880, 1090.

Section OEM# 060635.



OEM #	# of Sections	Order No	List
060969	38	S35-4203	204.83

### 9' RIVETED SICKLE - XHTSCR SECTIONS

Fits GEHL Mower Conditioner 2160.

Section OEM# 049254.

Head OEM# 6582530.



OEM #	# of Sections	Order No	List
6582522	37	S35-4318	177.05

### 12' RIVETED SICKLE - XHTSCR SECTIONS

Fits GEHL Mower Conditioner 2230 Swing Frame.

Section OEM# 049254.

Head OEM# 6193577.

OEM #	# of Sections	Order No	List
6272959	49	S35-4881	248.47

### 14' RIVETED SICKLE - XHTSCR SECTIONS

Fits GEHL Mower Conditioner 2262 Swing Frame.

Section OEM# 049254.

OEM #	Description	# of Sections	Head OEM	Order No	List
6832174	LH	28	6821078	S35-4390	275.74
6832224	RH	29	6821136	S35-4391	275.74

### UNIVERSAL SICKLES - BOLTED HEADLESS

Fits GEHL 880, 1090, 2130, 2160



Description	Order No	List
7' XH7TS Knf	S35-1038	94.93
9' XH7TS Knf	S35-1039	111.45

### FORGED STEEL GUARD

Fits GEHL MA206A. Replaces FS65-2, HA270, 044779.

Order No	List
G81-0035	13.05



### FORGED STEEL GUARD

Fits GEHL HK108, HK440, 770, 880, 1070, 1090. Replaces HA250, FS86-2, 049312, 060494.

Order No	List
G81-0120	13.18



### FORGED STEEL GUARD

Fits GEHL 770, 880, 1070, 1090. Replaces HA220, FS82-2, 059827, 072057.

Order No	List
G81-0185	14.12



### FORGED STEEL GUARD

Fits GEHL Mower Conditioner 2230, 2240, 2262 Swing Frame. Replaces FS66-2, HA245, 748178, 611179, 611902. Center guard.

Order No	List
G81-0192	9.38



### FORGED STEEL GUARD

Replaces HA206, BU206, 110-32342.

Order No	List
G81-0140	19.14



### MALLEABLE GUARD

Fits GEHL Mower Conditioner. Replaces MC2041Z, H7540, MA188. Center guard.

Order No	List
G81-0830	9.66



### RAKE TEETH

Fits GEHL Rake Models 207, 208, 216, 217, 218. Replaces 611181. 100/pkg.

Order No	List
T16-0030	3.93



### HOLD DOWN CLIPS NON-ADJUSTABLE

Use with guard G81-0120. Steel.

Style	Order No.	List
Low Arch	C45-0502	6.59
High Arch	C45-0503	10.03





HERSCHEL sections are made in the USA from high quality boron steel. Heat-treated for long life. Sections are extra heavy (.116") and chrome unless stated otherwise.

All HART CARTER sections have 2-1/16" hole spacing.

### SECTION TYPES

- |                                |                    |
|--------------------------------|--------------------|
| 7TS = Super 7® Top Serrated    | TT = Tiger Tooth   |
| SM = Smooth                    | TJ = Tiger Jaw     |
| US = Under Serrated - 14 Tooth | SRK = Tiger Shark™ |
| TS = Top Serrated - 14 Tooth   |                    |



**SECTION - XHTSCR**  
Fits HART CARTER Combines, Floating bar. Section is 3" x 2-1/2". Use 5/8 CS Rivet. Sold 10 sections per pack.

Replaces Number	Order No	List
277444	S20-4462	18.81



**SECTION - XH7TSCR**  
Fits HART CARTER Combines, Floating bar. Section is 3" x 2-1/2". Use 5/8 CS Rivet. Sold 10 sections per pack.

Replaces Number	Order No	List
SS277444	S20-4322	17.46



**SICKLE HEAD**  
Fits HART CARTER Combines, Floating bar, Newest Style Wobble Drive Head Gen III.

Replaces Number	Order No	List
880662	H15-0194	118.02

### WHY TRY TIGER SHARK™ SECTIONS?

1. Serrated teeth allow more cutting surface.
2. They last longer, cut faster.
3. Cuts equally well in soybeans, alfalfa, grass hay, wheat, etc.



#### Customer Testimonial:

"I cut over 1000 acres of soybeans with the same *Herschel Tiger Shark™* sections. They stayed sharper longer and lasted longer than any section I have used." - Roger Woodruff, Warren Co. Iowa

### UNIVERSAL END SECTIONS

HERSCHEL "End Sections" are made of one-piece high carbon, heat-treated steel for rugged use. They are punched with an oblong hole to virtually fit any standard cutterbar mower in use today. To install our "End Section", simply take off the last section on the shoe end of your sickle assembly and replace it with an "End Section". The change-over takes only a couple of minutes to complete and you will notice a big difference in time saved from unclogging your mower. We recommend using a R36-0523D oval head rivets or B55-0065D Bolts.



Description	Order No	List	Description	Order No	List
XH7TSCR (RH) 10/Box	S20-4403	38.49	Tiger Shark™ (RH) 2/SP	S20-8445D	12.06
XH7TSCR (RH) 2/SP	S20-4403D	10.54	XHTS CR (RH) 10/Box	S20-4210	38.49
Tiger Shark™ (RH) 10/Box	S20-8403	45.13	XHTS CR (RH) 2/SP	S20-4210D	10.54
Tiger Shark™ (RH) 2/SP	S20-8403D	12.06	XHTSCR (LH) 10/Box	S20-4211	38.49
XH7TSCR (LH) 10/Box	S20-4445	41.22	XHTSCR (LH) 2/SP	S20-4211D	10.54
XH7TSCR (LH) 2/SP	S20-4445D	13.94	XHUSCR (RH) 10/Box	S20-6640	40.77
Tiger Shark™ (LH) 10/Box	S20-8445	45.13	XHUSCR (RH) 2/SP	S20-6640D	10.54



### SECTION BOLTS

- Quick and easy section changes are possible with bolts.
- No more cutting, chiseling, or grinding - simply unbolt the section, replace and tighten bolts.
- Bolts will not turn in Knife Back and are reusable. They will last thru the life of several sections.
- Bolts may be replaced easily if accidentally damaged or broken.
- No special tools are needed to change sections, only a 7/16" wrench or socket.
- Bolt and nuts hold better than rivets and they have a greater "clamp load" than rivets.
- Special lock nuts will not vibrate loose.

Description	Pkg.	Qty. Mstr.	Qty. Order No.	List
9/16" CS Section Bolt & Nut	20	120	B55-0056D	10.82
1" CS Head Bolt & Nut	10	60	B55-0058D	8.56

### SICKLES - XHTSCR SECTIONS

Fits HART CARTER Generation III and AC Series 2 Floating Bar (Wobble Drive Hd.)

Section OEM# 277444.  
Head OEM#: 880662.

OEM #	Length	# of Sections	Order No	List
880644	13'	53	S35-4230	333.90



**HAMMER RIVET TOOL**  
For Drive Rivets

Order No.	List
T55-0812	30.72



**WEAR PLATE - 6"**  
Fits Windrowers. Replaces 7382.

Order No.	List
P44-0417	2.53

<b>B</b>	
Baler Teeth.....	29
Bolts, Section .....	26
<b>C</b>	
Clips, Hold Down .....	26
<b>D</b>	
Disc Mower Knives.....	29
<b>E</b>	
End Sections .....	25
<b>G</b>	
Guards.....	26
<b>H</b>	
Hold Down Clips .....	26
<b>O</b>	
Overlap Sections .....	25
<b>R</b>	
Rivets, Section.....	26
<b>S</b>	
Sections.....	25
Section Bolts.....	26
Section Rivets.....	26
Sickle Assemblies.....	27 - 28
Sickle Heads.....	28
<b>T</b>	
Teeth, Baler .....	29
<b>W</b>	
Windrower Teeth .....	29

HERSCHEL sections are made in the USA from high quality boron steel. Heat-treated for long life. Sections are extra heavy (.116") and chrome unless stated otherwise.

All HESSTON sections have 2-1/16" hole spacing.

## SECTION TYPES

- |                                |                    |
|--------------------------------|--------------------|
| 7TS = Super 7® Top Serrated    | TT = Tiger Tooth   |
| SM = Smooth                    | TJ = Tiger Jaw     |
| US = Under Serrated - 14 Tooth | SRK = Tiger Shark™ |
| TS = Top Serrated - 14 Tooth   |                    |

**SECTIONS**  
Fits HESSTON Mowers. Section is 3" x 3-1/4". Sold 10 sections per pack.

OEM#	Description	Design	Rivet Used	Order No	List
048009	XHUSCR	B-	1/2 OH	S20-6339	13.30
049262	XHSMCR	H	9/16 OH	S20-2758	20.44

## WHY TRY TIGER SHARK™ SECTIONS?

1. Serrated teeth allow more cutting surface.
2. They last longer, cut faster.
3. Cuts equally well in soybeans, alfalfa, grass hay, wheat, etc.



### Customer Testimonial:

"I cut over 1000 acres of soybeans with the same *Herschel Tiger Shark™* sections. They stayed sharper longer and lasted longer than any section I have used." - Roger Woodruff, Warren Co. Iowa

### Our Agricultural Background - Cutting Parts

Founded in 1887, by two brothers, Paul E and H. Robert Herschel. R. Herschel Manufacturing quickly became a leader in the sickle section industry.

For more than 130 years HERSCHEL has been an innovator in the cutting parts industry and introduced the chrome plated section (1950), Tiger Jaw® (1981) and Tiger Jaw 2000® (1997) combine conversion kits, Super 7® sections (1992) and most recently the Tiger Shark™ section (2016). Cutting parts designed to provide the agricultural industry with a high quality product at an exceptional value. We are proud to still make our popular cutting products at our factory in Indianola, IA.

**SECTIONS**  
Fits HESSTON Windrowers and Mower Conditioners. Section is 3" x 3-1/4". Uses a 5/8" OH Rivet. Sold 10 sections per pack.

The *Tiger Shark™* section can be used in place of the sections listed below.

OEM#	Description	Order No	List
	<i>Tiger Shark™</i>	<b>S20-8268</b>	<b>13.37</b>
700705300	XHTSCR	S20-4277	15.39
700705300	XH7TSCR	S20-4268	12.75
700705299	XH7TS	S20-3325	10.54

**TIGER TOOTH SECTIONS**  
Fits all HESSTON Mower Conditioners & Windrowers. Section is 3" x 3-1/4". Uses B55-0065D bolt. Sold 10 sections per pack.

OEM#	Description	Design	Order No	List
TT049254	XHTTCR	R	S20-4639	17.63
SSTJ7000	XH7TTCR	R+	S20-4317	17.62

## UNIVERSAL END SECTIONS

HERSCHEL "End Sections" are made of one-piece high carbon, heat-treated steel for rugged use. They are punched with an oblong hole to virtually fit any standard cutterbar mower in use today. To install our "End Section", simply take off the last section on the shoe end of your sickle assembly and replace it with an "End Section". The change-over takes only a couple of minutes to complete and you will notice a big difference in time saved from unclogging your mower. We recommend using a R36-0523D oval head rivets or B55-0065D Bolts.

Description	Order No	List	Description	Order No	List
XH7TSCR (RH) 10/Box	S20-4403	38.49	<i>Tiger Shark™ (LH) 2/SP</i>	<b>S20-8445D</b>	<b>12.06</b>
XH7TSCR (RH) 2/SP	S20-4403D	10.54	XHTS CR (RH) 10/Box	S20-4210	38.49
<i>Tiger Shark™ (RH) 10/Box</i>	<b>S20-8403</b>	<b>45.13</b>	XHTS CR (RH) 2/SP	S20-4210D	10.54
<i>Tiger Shark™ (RH) 2/SP</i>	<b>S20-8403D</b>	<b>12.06</b>	XHTSCR (LH) 10/Box	S20-4211	38.49
XH7TSCR (LH) 10/Box	S20-4445	41.22	XHTSCR (LH) 2/SP	S20-4211D	10.54
XH7TSCR (LH) 2/SP	S20-4445D	13.94	XHUSCR (RH) 10/Box	S20-6640	40.77
<i>Tiger Shark™ (LH) 10/Box</i>	<b>S20-8445</b>	<b>45.13</b>	XHUSCR (RH) 2/SP	S20-6640D	10.54

### HALF SECTION - XHSMCR

Fits HESSTON Windrowers. Uses 1/2" OH rivet. Sold 10 sections per pack. OEM# 048868.

**Order No List**  
S20-2521 23.69

### OVERLAP SECTION - XHTSCR - B TYPE

Fits HESSTON Mower Conditioner overlap. Use 3 on right hand and 2 on left hand. Section is 3" x 3-1/4". Sold 10 sections per pack. Replaces OEM# TS635161.

**Order No List**  
S20-4371 23.65

### OVERLAP SECTION - XH7TSCR - B+ TYPE

Fits HESSTON 1170 & 8400 Windrowers. Section is 3" x 3-1/4". Uses bottom CS rivet. Sold 10 sections per pack. Replaces OEM# SSTS635161

**Order No List**  
S20-4309 17.32

### OVERLAP SECTION KIT - 14 TOOTH

Fits HESSTON 1170, 8840, 666, 6665 Head-ers. Kit contains 5 of S20-4371, (3 right hand and 2 left hand sections), 10 bolts/nuts (B55-0059 countersunk).

Order No	List
S20-4003	23.14

### OVERLAP SECTION KIT - 14 TOOTH

Fits HESSTON 1014+2, 6450, 6455, 6556, 6855, 6866, 6650, 6655, 6660, 6665, 8100 Auger. Kit contains 5 sections, 1 wear bar and 11 bolts.

Order No	List
S20-4007	18.98

**1-YEAR WARRANTY  
ON ALL ITEMS!**

### SECTION BOLTS

- Quick and easy section changes are possible with bolts.
- No more cutting, chiseling, or grinding - simply unbolt the section, replace and tighten bolts.
- Bolts will not turn in Knife Back and are reusable. They will last thru the life of several sections.
- Bolts may be replaced easily if accidentally damaged or broken.
- No special tools are needed to change sections, only a 7/16 wrench or socket.
- Bolt and nuts hold better than rivets and they have a greater clamp load than rivets.
- Special lock nuts will not vibrate loose.

Description	Application	Qty. Pkg.	Mst Ctn.	Order No	List
Section Bolt w/nut	Universal - Replaces 9/16 & 5/8 OH Rivets	50	300	B55-0065D	9.55
Head Bolt w/nut	Universal - Replaces 1-1/2 & 1-1/16 OH Rivets	15	90	B55-0085D	5.85
Head Bolt w/nut	Universal - Replaces 1-1/2 OH Rivets	12	72	B55-0095D	6.02
Section Bolt w/nut	Universal Bolts for 10' Sickle w/Head Bolts (80-B55-0065D, 5-B55-0085D, 5-B55-0095)	90	Each	B55-0500D	22.76
Overlap Bolt w/Low Profile Nut*	Double Drive Sickles, replaces 1/2 CS rivets 60° Head	10	60	B55-0059D	7.06
Nut	Universal-Used on all the above bolts except B55-0050D	20	120	N83-0289D	5.36
Low Profile Nut	Overlap Sickles, use B55-0059D	20	120	N83-0295D	5.45



### SECTION RIVETS - ZINC PLATED

OH = Oval Head CS = Counter Sunk

Size/No. in Pkg.	Application	Qty. Pkg.	Mstr. Ctn.	Order No	List
5/8" # 5-1/2 (56)	7' Heavy Mower Sections and Knife Heads	Asst.	6	R36-0523D	7.75
1" # 5-1/2 (10)	Mower Conditioners	Asst.	6	R36-0524D	9.39
5/8" # 5-1/2 (72)					
1" # 5-1/2 (5)					
1-1/4" # 5-1/2 (5)					
9/16" OH #5-1/2	Heavy Gauge Sections	1#	6#	R36-0461D	9.28
5/8" OH #5-1/2	Heavy Gauge Sections	1#	6#	R36-0462D	13.40
15/16" OH #5-1/2	Head Rivet	1/2#	3#	R36-0522D	6.32
1-1/4" OH #5-1/2	Head Rivet	1/2#	3#	R36-0467D	6.83
5/8" CS #5-1/2	Section Rivet	1#	6#	R36-0463D	10.94
1-1/4" CS #5-1/2	Guard Plate Rivet	1/2#	3#	R36-0468D	6.63



### HOLD DOWN CLIPS NON-ADJUSTABLE



Fits all HESSTON Mower Conditioners and Windrowers. Steel.

Style	Order No.	List
Low Arch	C45-0692	3.57
High Arch	C45-0693	4.79

### FORGED STEEL GUARD

Fits all HESSTON Mower/Cond. & Windrowers. Replaces 049312, FS 86-2, BU250 AND HA250. Stub guard.



Order No	List
G81-0120	13.18

### FORGED STEEL GUARD

Fits all HESSTON Windrowers. Replaces 049270, FT-77-2, HA260. Tie guard



Order No	List
G81-0085	14.40

### FORGED STEEL GUARD

Fits all HESSTON Super Guard, Mower Conditioners and Windrowers. Replaces 700700845, FS 66-DH, BU245H, HA245H. Double Heat Treated.



Order No	List
G81-0042	13.92

### HOLD DOWN CLIPS ADJUSTABLE

Fits all HESSTON Mowers, Windrowers & Swathers. Cast.



Style	Order No.	List
Low Arch	C45-0006	21.39
High Arch	C45-0007	21.39



Fits all HESSTON Windrowers and Mower Conditioners. Steel.

Style	Order No.	List
Low Arch	C45-0040	5.65



4.79fits all HESSTON Mower Conditioners and Windrowers with stub guard G81-0120. Steel.

Style	Order No.	List
Low Arch	C45-0502	6.59
High Arch	C45-0503	10.03



Fits HESSTON Windrowers using guard 049270 (G81-0085). Steel tie plate.

Style	Order No.	List
Low Arch	C45-0500	6.44
High Arch	C45-0501	13.44

## MOWER CONDITIONERS PT-7, PT-10, 1010

OEM #	Length	No. Of Sections	Head	Head OEM #	Type	Section	Section OEM #	Riveted Order No	Riveted List	Bolted Order No	List
6193510 HD	7'	30	H15-0880	451948 HD	XHTSCR	S20-4013	049213	S35-4593	132.51	-	-

## MOWER CONDITIONERS PT-7, PT-10, 1011

OEM #	Length	No. Of Sections	Head	Head OEM #	Type	Section	Section OEM #	Riveted Order No	Riveted List	Bolted Order No	List
6566178 HD	9'	38	-	-	XHTSCR	S20-4564	049254	-	-	S35-2359	189.00

## MOWER CONDITIONERS PT-12

OEM #	Length	No. Of Sections	Head	Head OEM #	Type	Section	Section OEM #	Riveted Order No	Riveted List	Bolted Order No	List
429498	12'	49	-	433102	XHTSCR	S20-4013	049213	S35-4325	329.57	-	-

## MOWER CONDITIONERS 1070, 1071, 1085, 1090, 1091, 1095

OEM #	Length	No. Of Sections	Head	Head OEM #	Type	Section	Section OEM #	Riveted Order No	Riveted List	Bolted Order No	List
6584031, 70071198	7'	28	-	-	XHTSCR	S20-4564	049254	S35-4317	228.39	-	-

## MOWER CONDITIONERS 1070, 1071, 1085, 1090, 1091, 1096

OEM #	Length	No. Of Sections	Head	Head OEM #	Type	Section	Section OEM #	Riveted Order No	Riveted List	Bolted Order No	List
6582522, 700711979	9'	37	-	-	XHTSCR	S20-4564	049254	S35-4318	177.05	-	-

## MOWER CONDITIONERS 1070, 1071, 1085, 1090, 1091, 1097

OEM #	Length	No. Of Sections	Head	Head OEM #	Type	Section	Section OEM #	Riveted Order No	Riveted List	Bolted Order No	List
SS6582522	9'	37	-	-	XH7TSCR	S20-4268	SS700705300	-	-	S35-2728	242.30

## WINDROWERS 200, 220, 240, 260, 280, 300, 500

OEM #	Length	No. Of Sections	Head	Head OEM #	Type	Section	Section OEM #	Riveted Order No	Riveted List	Bolted Order No	List
373530 S	14'	57	-	-	XHTSCR	S20-4013	049213	-	-	S35-2291	272.33
373530 HS	14'	57	-	-	XHTSCR	S20-4564	049254	S35-4452	228.38	-	-

## WINDROWERS 520, 620, 1014 HYDRO-SWING, 6200, 6400, 6465, 6550, 6600, 6610 11 HOLE HEAD

OEM #	Length	No. Of Sections	Head	Head OEM #	Type	Section	Section OEM #	Riveted Order No	Riveted List	Bolted Order No	List
6272959	12'	49	-	6193577	XHTSCR	S20-4564	049254	S35-4881	248.47	-	-
SSTT6497101	12'	50	-	TT6497416	XH7TSCR	S20-4317	SSTJ7000	-	-	S35-2375	307.20
6272967	14'	57	-	6193577	XHTSCR	S20-4564	049254	S35-4879	304.36	-	-

## WINDROWERS 520, 620, 1014 HYDRO-SWING, 6200, 6400, 6450, 6550, 6600, 6610 21 HOLE HEAD

OEM #	Length	No. Of Sections	Head	Head OEM #	Type	Section	Section OEM #	Riveted Order No	Riveted List	Bolted Order No	List
6497101	12'	49	-	-	XHTSCR	S20-4564	049254	-	-	S35-2101	301.31
SSTT6497101	12'	50	-	-	XH7TSCR	S20-4317	SSTJ7000	-	-	S35-2375	307.20
SS6497119	14'	57	-	-	XH7TSCR	S20-4268	SS700705300	-	-	S35-2730	331.29
6497374	16'	65	-	-	XHTSCR	S20-4564	049254	-	-	S35-2731	364.68
700705843											
6206031	14'	57	Headless	-	XHTSCR	S20-4013	049213	-	-	S35-2291	272.33
6497465	14'	57	Headless	-	XHTSCR	S20-4564	049254	S35-4452	228.38	-	-

## WINDROWERS 1014+2 HYDRO SWING, 6450, 6455, 6550, 6555, 6566, 6650, 6655, 6660, 6665, 8100 AUGER HEADER, 21' DRAPER HEADER

OEM #	Length	No. Of Sections	Head	Head OEM #	Type	Section	Section OEM #	Riveted Order No	Riveted List	Bolted Order No	List
6832174	7' LH	25	H15-0390	6821078	XHTSCR	S20-4564	049254	S35-4390	275.74	-	-
SS6832174	7' LH	25	H15-0390	6821078	XH7TSCR	S20-4268	SS700705300	-	-	S35-2285	224.04
6832224	7' RH	25	H15-0301	6821136	XHTSCR	S20-4564	049254	S35-4391	275.74	-	-
SS6832224	7' RH	25	H15-0301	6821136	XH7TSCR	S20-4268	SS700705300	-	-	S35-2286	223.91
6832182	8' LH	29	H15-0390	6821078	XHTSCR	S20-4564	049254	S35-4388	290.97	-	-
SS6832182	8' LH	29	H15-0390	6821078	XH7TSCR	S20-4268	SS700705300	-	-	S35-2325	275.45
6832232	8' RH	29	H15-0301	6821136	XHTSCR	S20-4564	049254	S35-4389	290.97	-	-
SS6832232	8' RH	29	H15-0301	6821136	XH7TSCR	S20-4268	SS700705300	-	-	S35-2326	275.45

## MOWER CONDITIONERS 1170, 1270, 1275; WINDROWERS 8020, 8400, 8450, 8600 WITH 625 AUGER HEADERS

OEM #	Length	No. Of Sections	Head	Head OEM #	Type	Section	Section OEM #	Riveted Order No	Riveted List	Bolted Order No	List
SS700114590	7' LH	28	H15-0063	700114594	XH7TSCR	S20-4268	SS700705300	-		S35-2001	206.68
SS700709581	7' LH	28	Headless	-	XH7TSCR	S20-4268	SS700705300	-		S35-2003	133.52
SS700114591	7' RH	28	H15-0063	700114594	XH7TSCR	S20-4268	SS700705300	-		S35-2002	210.39
SS700709582	7' RH	28	Headless	-	XH7TSCR	S20-4268	SS700705300	-		S35-2004	133.52
700114590	7' LH	28	H15-0063	700114594	Tiger Shark™	S20-8268				S35-2517	191.96
700114591	7' RH	28	H15-0063	700114594	Tiger Shark™	S20-8268				S35-2519	206.27
700715165	7' LH	28	H15-0063	700114594	XHTSCR	S20-4277	700705300	-		S35-2067	281.68
700715166	7' RH	28	H15-0063	700114594	XHTSCR	S20-4277	700705300	-		S35-2068	281.68
SS700114592	8' LH	32	H15-0063	700114594	XH7TSCR	S20-4268	SS700705300	-		S35-2014	224.86
					Tiger Shark™	S20-8268				S35-2528	218.57
SS700709585	8' LH	32	Headless	-	XH7TSCR	S20-4268	SS700705300	-		S35-2017	166.93
SS700114593	8' RH	32	H15-0063	700114594	XH7TSCR	S20-4268	SS700705300	-		S35-2015	224.86
					Tiger Shark™	S20-8268				S35-2532	211.08
SS700709586	8' RH	32	Headless	-	XH7TSCR	S20-4268	SS700705300	-		S35-2016	166.93
700715167	8' LH	32	H15-0063	700114594	XHTSCR	S20-4277	700705300	-		S35-2069	263.78
700114894	8' LH	32	Headless	-	XHTSCR	S20-4277	700705300	-		S35-2111	249.26
700715168	8' RH	32	H15-0063	700114594	XHTSCR	S20-4277	700705300	-		S35-2070	263.78
700715168	8' RH	32	Headless	-	XHTSCR	S20-4277	700705300	-		S35-2112	249.26
SS700715778	9' LH	36	H15-0063	700114594	XH7TSCR	S20-4268	SS700705300	-		S35-2305	316.80
SS700715778	9' LH	36	Headless	-	XH7TSCR	S20-4268	SS700705300	-		S35-2306	215.99
SS700715779	9' RH	37	H15-0063	700114594	XH7TSCR	S20-4268	SS700705300	-		S35-2309	316.54
700715778	9' LH	36	H15-0063	700114594	XHTSCR	S20-4277	700705300	-		S35-2307	342.80
700715778	9' LH	36	Headless	-	XHTSCR	S20-4277	700705300	-		S35-2308	191.76
700715779	9' RH	37	H15-0063	700114594	XHTSCR	S20-4277	700705300	-		S35-2311	380.92
700715779	9' RH	37	Headless	-	XHTSCR	S20-4277	700705300	-		S35-2312	194.76

### MOWER CONDITIONER 1130

OEM #	Length	No. Of Sections	Head	Head OEM #	Type	Section	Section OEM #	Riveted Order No	Riveted List	Bolted Order No	List
700118673	9'	37	H15-0066	700111003	XHTSCR	S20-4277	700705300	-		S35-2071	272.48

### MOWER CONDITIONER 1110

OEM #	Length	No. Of Sections	Head	Head OEM #	Type	Section	Section OEM #	Riveted Order No	Riveted List	Bolted Order No	List
700000573	7'	27	H15-0390	6821078	XHTSCR	S20-4564	049254	-		S35-2080	339.75
700111432											

### MOWER CONDITIONER 1120

OEM #	Length	No. Of Sections	Head	Head OEM #	Type	Section	Section OEM #	Riveted Order No	Riveted List	Bolted Order No	List
SS700111430	9'	35	H15-0390	6821078	XH7TSCR	S20-4268	SS700705300	-		S35-2081	215.26

### MOWER CONDITIONER 1150

OEM #	Length	No. Of Sections	Head	Head OEM #	Type	Section	Section OEM #	Riveted Order No	Riveted List	Bolted Order No	List
S700109341	12'	46	H15-0390	6821078	XH7TSCR	S20-4268	SS700705300	-		S35-2082	308.81

## WINDROWERS 1160, 1260, 1265, 8200 CENTER PIVOT WITH 425 HEADER

OEM #	Length	No. Of Sections	Head	Head OEM #	Type	Section	Section OEM #	Riveted Order No	Riveted List	Bolted Order No	List
700709622	12'	48	H15-0066	700111003	XHTSCR	S20-4277	700705300	-		S35-2072	298.85
700709623	14'	56	H15-0066	700111003	XHTSCR	S20-4277	700705300	-		S35-2073	326.63

#### SICKLE HEAD

Fits HESSTON Single Drive 1130, 1160, 8200.

Replaces	Order No	List
700111003	H15-0066	147.65

#### SICKLE HEAD

Fits HESSTON Double Drive 1170, 8400, 8450, 8020, 8600. Double needle bearing. Left hand/Right hand.

Replaces	Order No	List
700114594	H15-0063	103.22

## HERSCHEL DISC MOWER KNIVES - MADE IN THE USA

- Manufactured in the U.S.A. to meet ISO 5718 standard on Knives for agricultural rotary disc mowers.
- Manufactured from high quality U.S.A. 10B38 (boron) steel.
- Edges are formed not ground to prevent edges from chipping & breakage.
- Entire knife is belt, not batch heat treated to a RC hardness of 45-52. Batch heat treating can cause knives on the inside of the batch to vary greatly in hardness compared to knives on the outside of the batch.
- Each knife is stamped with our name, date and lot number to allow us to trace the manufacturing process on each knife. This allows traceability of the steel back to the steel mill and the mills heat lot of the steel used in the knife.

### DISC MOWER KNIVES

Fits HESSTON 1004, 1005, 1006, 1007, 1008, 3006, 3007, 3008, 3009, 3010, 3309.

Length: 4.76" Degree of Twist: 13 Hole Diameter: .89  
Width: 1.88 Thickness: 0.165 Center Of Hole To Back Edge: .78

OEM Number	Style	Shape	Bolt Order No	6 Blades Order No	List	25 Blades Order No	List
527746	5	RH Twisted	B55-0355D	B45-6563D	10.51	B45-6563	41.18
527747	5	LH Twisted	B55-0355D	B45-6564D	10.51	B45-6564	41.18



### DISC MOWER KNIVES

Fits HESSTON 1030, 1035, 1040, 1050, 1060.

Length: 3.66" Degree of Twist: 13 Hole Diameter: .64  
Width: 1.60 Thickness: 0.116 Center Of Hole To Back Edge: .80

OEM Number	Style	Shape	Bolt Order No	6 Blades Order No	List	25 Blades Order No	List
DM303	4	LH Twisted	B55-0358D	B45-6996D	10.18	B45-6996	30.57
DM304	4	RH Twisted	B55-0358D	B45-6997D	10.18	B45-6997	35.62



### DISC MOWER KNIVES

Fits HESSTON 1320, 1340, 1345, 1355, 1360, 1365, 1375, 3312, 3315, 8070, 8500, 9070, 9075, 9080, 9190, 9192

Length: 4.21" Degree of Twist: 13 Hole Diameter: .72  
Width: 1.78 Thickness: 0.169 Center Of Hole To Back Edge: .80

OEM Number	Style	Shape	Bolt Order No	6 Blades Order No	List	25 Blades Order No	List
700713983	4	RH Twisted	B55-0344D	B45-6568D	9.83	B45-6568	39.24
700713984	4	LH Twisted	B55-0344D	B45-6569D	9.83	B45-6569	39.24



### DISC MOWER KNIVES - 18 DEGREE TOP BEVEL

Fits HESSTON 8070, 1320, 1340, 1360, 1365

Length: 4.21" Degree of Twist: 18 Hole Diameter: .73  
Width: 1.89 Thickness: 0.157 Center Of Hole To Back Edge: .75

OEM Number	Shape	Bolt Order No	6 Blades Order No	List	25 Blades Order No	List
86625673	LHTwisted	B55-0342D	B45-6725D	11.75	B45-6725	40.79
86625674	RHTwisted	B55-0342D	B45-6726D	11.75	B45-6726	40.79

### DISC MOWER KNIVES - 18 DEGREE BOTTOM BEVEL

Fits HESSTON 8070, 1320, 1340, 1360, 1365

Length: 4.21" Degree of Twist: 18 Hole Diameter: .73  
Width: 1.88 Thickness: 0.163 Center Of Hole To Back Edge: .78

OEM Number	Shape	Bolt Order No	6 Blades Order No	List	25 Blades Order No	List
86625673	LHTwisted	B55-0342D	B45-6572D	10.96	B45-6572	39.90
86625674	RHTwisted	B55-0342D	B45-6573D	10.96	B45-6573	39.90

### DISC MOWER KNIVES

Fits HESSTON 8500.

Length: 4.21" Degree of Twist: 13 Hole Diameter: .73  
Width: 1.86 Thickness: 0.157 Center Of Hole To Back Edge: .78

OEM Number	Style	Shape	Bolt Order No	6 Blades Order No	List	25 Blades Order No	List
700715576	5	RH Twisted	B55-0342D	B45-6559D	9.39	B45-6559	37.96
700715575	5	LH Twisted	B55-0342D	B45-6560D	9.39	B45-6560	37.96



### RAKE TOOTH

For HESSTON 3700,3800, 3810, 3900, 3950. 100 per box.

Order No.	List
T16-0185	3.65



### SPRING TOOTH

For HESSTON Windrowers, Pickup and Forage Harvester. Replaces 7894751. 100 per box.

Order No.	List
T16-0012	13.92



### SPRING TOOTH

For HESSTON Windrowers PT-10 420, 620, 6600 & 1014. Replaces 750075. 100 per box.

Order No.	List
T16-0030	13.92



### BALER TOOTH

For HESSTON Baler, Large Round, 5600 & 5800. Replaces 7751621. 100 per box.

Order No.	List
T16-0040	13.92

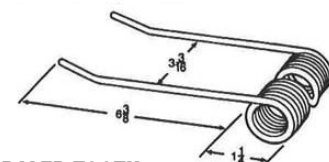

### BALER TOOTH

For HESSTON 4900. Replaces 700706128. 100 per box.

Order No.	List
T16-0163	13.92

### BALER TOOTH

For HESSTON 48W, 1 TON FREEMAN. Replaces 7893746. 100 per box.

Order No.	List
T16-0164	13.92

# HONEY BEE

HERSCHEL sections are made in the USA from high quality boron steel. Heat-treated for long life. Sections are extra heavy (.116") and chrome unless stated otherwise.

## WHY TRY TIGER SHARK™ SECTIONS?

1. Serrated teeth allow more cutting surface.
2. They last longer, cut faster.
3. Cuts equally well in soybeans, alfalfa, grass hay, wheat, etc.



### Customer Testimonial:

"I cut over 1000 acres of soybeans with the same *Herschel Tiger Shark™* sections. They stayed sharper longer and lasted longer than any section I have used." - Roger Woodruff, Warren Co. Iowa



S20-8498

S20-4498

S20-3513

### SECTIONS

Fits HONEY BEE Heads with Schumacher Easy Cut System. Sold 10 sections per pack.

The *Tiger Shark™* section can be used in place of the sections listed below.

OEM #	Description	Order No	List
26208	<i>Tiger Shark™</i>	S20-8498	18.12
26208	XH7TSCR	S20-4498	17.20
26208	XH7TS	S20-3513	15.72

### SECTION TYPES

7TS = Super 7® Top Serrated	TT = Tiger Tooth
SM = Smooth	TJ = Tiger Jaw
US = Under Serrated - 14 Tooth	SRK = Tiger Shark™
TS = Top Serrated - 14 Tooth	

### SECTION BOLT/NUT

Used on Honey Bee headers with SCH cutting systems. Replaces 420100012, 61711. M6-1.0x16. 50 per package.



Order No.	List
B55-0075D	23.53



HERSCHEL sections are made in the USA from high quality boron steel. Heat-treated for long life. Sections are extra heavy (.116") and chrome unless stated otherwise.

**SECTION TYPES**

- 7TS = Super 7® Top Serrated
- SM = Smooth
- US = Under Serrated - 14 Tooth
- TS = Top Serrated - 14 Tooth
- TT = Tiger Tooth
- TJ = Tiger Jaw
- SRK = Tiger Shark™



**SECTION - XHUS**  
Fits JE LOVE Green Pea Wind-  
rowers. Section is 3" x 3-3/16".  
Use 9/16 OH Rivet. Sold 10 sections  
per pack.

Replaces			
Number	Order No	List	
L191	S20-5246	11.24	



**SECTION - XH7TS**  
Fits JE LOVE TR308, TR310.  
Section is 3" x 3". Use 5/8 CS  
Rivet. Sold 10 sections per  
pack.

Replaces			
Number	Order No	List	
L192DS7	S20-3370	14.66	



**SECTION - XHTSCR**  
Fits JE LOVE TR409, TR510.  
Section is 3" x 3". Use 5/8 CS  
Rivet. Sold 10 sections per  
pack.

Replaces			
Number	Order No	List	
L192DCR	S20-4608	18.01	



**SECTION - XHTJCR**  
Fits JE LOVE Combines with  
Tiger Jaws, King Kut. Section  
is 3" x 3-1/4". Sold 10 sections  
per pack.

Replaces			
Number	Order No	List	
TJ6000	S20-4638	26.71	



**SECTION - XH7TJCR**  
Fits JE LOVE Combines with  
Tiger Jaws, King Kut. Section  
is 3" x 3-1/4". Sold 10 sections  
per pack.

Replaces			
Number	Order No	List	
SSTJ6000	S20-4316	17.62	



**WEAR PLATE - 6"**  
Standard and Adjustable.

Replaces			
Number	Order No.	List	
L220	P44-0417	2.53	

**Get Online With  
Herschel Parts!**

**HERSCHELPARTS.com**

You can shop 24 hours a  
day. 7 Days A Week!

We are also on Facebook  
and Twitter! Check out our  
pages today and stay up-to-  
date on all the things going  
on at Herschel!

**SECTION BOLTS**

- Quick and easy section changes are possible with bolts.
- No more cutting, chiseling, or grinding - simply unbolt the section, replace and tighten bolts.
- Bolts will not turn in Knife Back and are reusable. They will last thru the life of several sections.
- Bolts may be replaced easily if accidentally damaged or broken.
- No special tools are needed to change sections, only a 7/16 wrench or socket.
- Bolt and nuts hold better than rivets and they have a greater clamp load than rivets.
- Special lock nuts will not vibrate loose.

Description	Application	Pkg.	Qty. Mst Ctn.	Order No	List
Section Bolt*	Countersink, replaces 5/8 CS rivets. 60° Head	20	120	B55-0057D	5.05
Head Bolt*	Countersink, replaces 1 CS rivets	10	6	B55-0058D	8.56

\* Use with Allen Wrench

**FORGED STEEL GUARD**

Fits JE LOVE. Replaces FC90-2,  
BU275, LB208, LB214, HA275.



Order No	List
G81-0196	13.40

**FORGED STEEL GUARD**

Fits all TIGER JAWS. Replaces  
TJ44-4A. 4-Prong.



Order No	List
G81-0581	20.67

**GUARD BOLT**

#3 bolt. Replaces L1316,  
L1317. 50 bolts/nuts per  
package. 7/16" x 1-1/2".



Order No	List
B55-0260	19.95

**GUARD BOLT**

#3 bolt. Replaces LB318.  
50 bolts/nuts per package.  
7/16" x 1-3/4".



Order No	List
B55-0265	22.43

**BOLTED SICKLES, SPLICED  
HEADLESS**

Fits Both the Original Tiger Jaws and the  
Tiger Jaws 2000 Series, now all with Super  
7 Sections.



Size	Order No	List
1-Piece Universal		
16'	S35-2153	349.16
20'	S35-2155	427.33

Spliced Universal	Order No	List
4'	S35-2860	82.03
5'	S35-2276	105.95
8'	S35-2861	140.22
8.5' Drive Head Segment	S35-2862	141.11



S35-2860/2861



S35-2862

<b>B</b>	
Bale Counter.....	35
Baler Bearings.....	48
Baler Sprockets, Round.....	47 - 48
Baler Teeth.....	45
Bearings, Plastic Reel.....	46
Bolts, Section.....	36
<b>D</b>	
Disc Mower Knives.....	43
<b>C</b>	
Clips, Hold Down.....	36
Combine Cutterbar Replacement Kits.....	39
Combine Teeth.....	45
Corn Head Rollers.....	46
<b>E</b>	
End Sections.....	35
<b>G</b>	
Gathering Chain Sprockets.....	46
Grass Board.....	35
Guards.....	44
<b>H</b>	
Hammer Rivets.....	46
Hammer Rivet Tool.....	46
Hold Down Clips.....	36
<b>K</b>	
Kits, Combine Cutterbar Replacement.....	39
Kits, Overlap.....	35
<b>O</b>	
Overlap Kits.....	35
<b>P</b>	
Pick-Up Teeth.....	45
Pitman Woods.....	45
Plastic Reel Bearings.....	46
Plastic Tines.....	45
Poly Replacement Parts.....	45

<b>R</b>	
Rake Teeth.....	45
Rake Wheels.....	46
Reel Tines.....	45
Rivets, Hammer.....	46
Rivets, Section.....	36
Round Baler Bearings.....	48
Round Baler Sprockets.....	47 - 48
<b>S</b>	
Sections.....	33 - 34
Section Bolts.....	36
Section Rivets.....	36
Sickle Backs.....	39
Sickle Heads.....	42
Sickles.....	37 - 41
Splice Kits.....	40
Spliced Sickles.....	39 - 41
Sprockets, Round Baler.....	48
Sprockets, Gathering Chain.....	46
<b>T</b>	
Teeth, Baler.....	45
Teeth, Combine.....	45
Teeth, Pick-up.....	45
Tines, Reel.....	45
Tooth, Rake.....	45
<b>W</b>	
Wear Plate.....	42

HERSCHEL sections are made in the USA from high quality boron steel. Heat-treated for long life. Sections are extra heavy (.116") and chrome unless stated otherwise.

**All JOHN DEERE sections for combines have 2-1/16" hole spacing.**  
**All JOHN DEERE sections for hay machines have 2" hole spacing.**

### SECTION TYPES

- |   |                    |
|---|--------------------|
| 7TS = Super 7 <sup>®</sup> Top Serrated | TT = Tiger Tooth   |
| SM = Smooth                             | TJ = Tiger Jaw     |
| US = Under Serrated - 14 Tooth          | SRK = Tiger Shark™ |
| TS = Top Serrated - 14 Tooth            |                    |

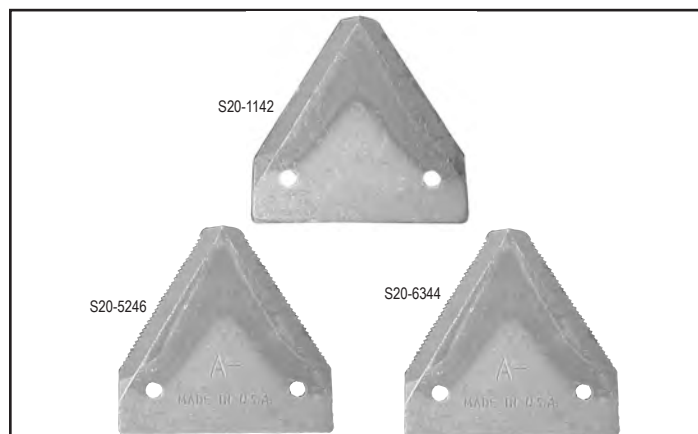

### SECTIONS

Fits JOHN DEERE Mowers, Mower Conditioners and Windrowers. Section is 3" x 3-3/16". Uses 9/16 OH rivet. Sold 10 sections per pack.

OEM #	Description	Design	Order No	List
E76372, Z6451H	XHSM	H	S20-1142	13.22
E76373, Z7030H	XHUS	A-	S20-5246	11.24
E76371, H21530H	XHUSCR	A-	S20-6344	20.22

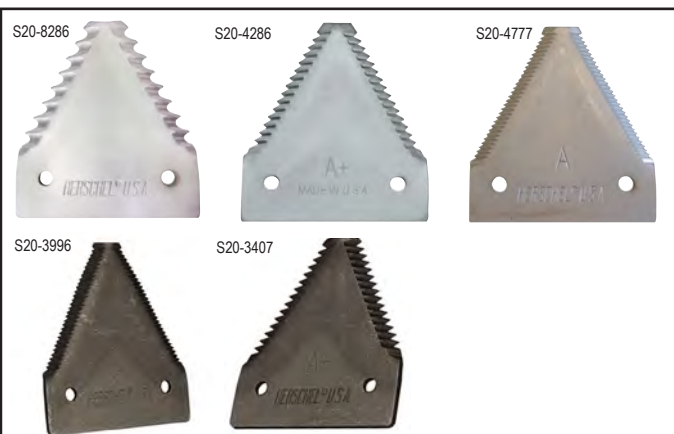

### SECTIONS

Fits JOHN DEERE Mowers, Conditioners and Windrowers. Section is 3" x 3-1/16". Uses 9/16 OH rivet. Sold 10 sections per pack. Replaces E45996, E76370 and E90571.

*The Tiger Shark™ section can be used in place of the sections listed below.*

Description	Design	Order No	List
<u>Tiger Shark™</u>		<u>S20-8286</u>	<u>13.51</u>
XH7TSCR	A+	S20-4286	12.85
XHTSCR	A	S20-4777	15.72
XHTS	A	S20-3996	12.49
XH7TS	A+	S20-3407	11.15
<u>Tiger Shark™ (TopCS)</u>	<u>A+</u>	<u>S20-8328</u>	<u>25.53</u>
<u>Tiger Shark™ (BtmCS)</u>	<u>A+</u>	<u>S20-8329</u>	<u>26.04</u>



### SECTIONS

Fits JOHN DEERE 140, 140A, 160A, 180A Auger Heads, 415D, 420D, 425D, 430D, 435D, 440D, 160 Series Draper Heads, 580 & 90 Windrowers, Mower Conditioners 1212, 1214 & 1216. Section is 3" x 3-1/4". Uses 5/8 OH rivet. Sold 10 sections per pack.

*The Tiger Shark™ section can be used in place of the sections listed below.*

OEM #	Description	Design	Order No	List
	<u>Tiger Shark™</u>		<u>S20-8398</u>	<u>14.81</u>
W34602CR, W35888CR	XH7TSCR	C+	S20-4398	14.10
W34602CR, W35888CR	XHTSCR	C	S20-4170	16.91
W34602, W35888	XHTS	5/8 OH	S20-3283	12.91



### SECTIONS

Fits JOHN DEERE Windrower, 300 Twin Drive Header. Section is 3" x 3-3/16". Uses 5/8 CS rivet. Sold 10 sections per pack.

OEM #	Description	Design	Order No	List
E71947	XHTSCR(Top CS)	A	S20-4130	27.72
E71947	XH7TSCR(TopCS) - overlap section	A+	S20-4328	23.32
E71948	XH7TSCR(BtmCS) - overlap section	A+	S20-4329	23.77



### SECTIONS

Fits JOHN DEERE Windrower 580, 590, 2360. Section is 3" x 3-1/4". Uses 9/16 OH rivet. Sold 10 sections per pack.

OEM #	Description	Design	Order No	List
W30344,W36402	XHUS	C-	S20-5236	12.74
W35888	XHTSCR	C	S20-4969	17.11



### SECTIONS

Fits JOHN DEERE 200 and 900 series headers. Section is 3" x 3-1/4". Uses bolt B55-0065D. Sold 10 sections per pack. 2 hole section.

*The Tiger Shark™ section can be used in place of the sections listed below.*

OEM #	Description	Design	Order No	List
	<b>Tiger Shark™</b>		<b>S20-8452</b>	<b>17.45</b>
H136807, H207930	XH7TSCR	N+	S20-4452	16.60
H136807, H207929	XHTSCR	N	S20-4451	16.60



### SECTION - XHTSCR

Fits JOHN DEERE Windrower 2360, Overlap. Section is 3" x 3-7/32". Uses 5/8 OH Rivet. Sold 10 sections per pack.

OEM#	Order No	List
34390CR-CSK	S20-4399	20.71



### SECTION - XHTSCR

Fits JOHN DEERE Windrower 2360 XH Shoulder. Section is 3" x 3-1/4". Uses 5/8 OH Rivet. Sold 10 sections per pack.

OEM#	Order No	List
W35888, 34390CR	S20-4097	15.15



### SECTIONS

Fits JOHN DEERE 600 Rigid & Flex, 900 Draper Headers. Section is 3" x 4". Use bolt B55-0600D. Sold 10 sections per pack.

*The Tiger Shark™ section can be used in place of the sections listed below.*

OEM #	Description	Order No	List
	<b>Tiger Shark™</b>	<b>S20-8531</b>	<b>26.51</b>
H163131	XH7TSCR	S20-4531	25.27
H153329	XHTSCR	S20-4532	25.27

S20-4267



S20-4719



### SECTIONS

Fits JOHN DEERE Combines with 200 & 900 series headers. Section is 3" x 3-1/4". Uses 5/8 OH Rivet. Sold 10 sections per pack.

OEM #	Description	Design	Order No	List
H84415, H213805	XH7TSCR	N+	S20-4267	17.92
H84415, H130478, H213815	XHTSCR	N	S20-4719	18.01

### SECTION

Fits JOHN DEERE 600 Series Double Drives. Top countersunk. Section is 3" x 4". Uses bolt B55-0075D. Sold 10 sections per pack.



OEM#	Description	Order No	List
H226351	<b>Tiger Shark™</b>	<b>S20-8540</b>	<b>51.65</b>
H226351	XH7TSCR	S20-4540	50.99

S20-4537



### SECTIONS

Fits JOHN DEERE 600 Rigid & Flex, 900 Draper Headers. Section is a half section. Uses bolt B55-0075D. Sold 10 sections per pack. *The Tiger Shark™ section can be used in place of the sections listed below.*

OEM #	Description	Order No	List
H163132	XH7TSCR	S20-4537	29.37
<b>H163132</b>	<b>Tiger Shark™</b>	<b>S20-8537</b>	<b>37.93</b>
H161242	XHTSCR	S20-4536	29.37
H163132	XH7TSCR	S20-4537D*	8.08
H161242	XHTSCR	S20-4536D*	8.08

\*Sold as a 2 pack.

S20-4639



### TIGER JAW SECTIONS

Fits JOHN DEERE Combines with Tiger Jaw systems. Section is 3" x 3-1/4". Uses bolt B55-0065D. Sold 10 sections per pack.

Description	Design	Order No	List
XHTJCR	R	S20-4639	17.63
XH7TJCR	R+	S20-4317	17.62
Blank 1/2 Section		S20-0297	21.74

S20-4317

**1-YEAR WARRANTY ON ALL ITEMS!**



### TIGER TOOTH SECTION

Fits JOHN DEERE Mowers and Mower Conditioners. Section is 3" x 3-1/8". Uses bolt B55-0065D. Sold 10 sections per pack. Replaces TTE45996.

Description	Order No	List
XH7TTCR	S20-4414	17.01



### TIGER TOOTH SECTIONS - XH7TTCR

Fits JOHN DEERE Windrower Overlap section. Section is 3" x 3-1/8". Uses bolt 5/8 CS rivet. Sold 10 sections per pack.

Replaces	Description	Order No	List
SSTTE71948	Bottom Countersunk	S20-4416	15.15

### MOWER/CONDITIONER OVERLAP SECTION KIT FOR DOUBLE DRIVES

Fits JOHN DEERE Mower and Mower Conditioner 300 Twin Drive Headers. Kit includes 1 of S20-4131, 3 of S20-4130 and 8 B55-0059 countersunk bolts and nuts.

Order No	List
S20-4002	20.76

### MOWER/CONDITIONER OVERLAP SECTION KIT FOR DOUBLE DRIVES

Fits JOHN DEERE 300, 1600, 890, 4890 Mowers. Kit includes 6 sections and 10 countersunk bolts and nuts.

Order No	List
S20-4006	20.67

### GRASS BOARD

Fits all mowers.



Order No	List
B52-0615	44.40

### BALE COUNTER

Bale counter, reads up to 99,999. 4-hole mounting plate, push button reset, adjustable side arm. Fits most balers.



Order No	List
T55-0002	25.30

### Our Agricultural Background - Cutting Parts

Founded in 1887, by two brothers, Paul E and H. Robert Herschel. R. Herschel Manufacturing quickly became a leader in the sickle section industry.

For more than 130 years HERSCHEL has been an innovator in the cutting parts industry and introduced the chrome plated section (1950), Tiger Jaw® (1981) and Tiger Jaw 2000® (1997) combine conversion kits, Super 7® sections (1992) and most recently the Tiger Shark™ section (2016). Cutting parts designed to provide the agricultural industry with a high quality product at an exceptional value. We are proud to still make our popular cutting products at our factory in Indianola, IA.

### COMBINE OVERLAP SECTION KIT - XH7TSCR

Fits JOHN DEERE 600 SERIES HEADERS. Includes 5 countersunk sections, 1 overlap rectangle plate, 12 6MM CTSK bolts, 12 6MM nuts.

Order No	List
S20-4011	53.85

### COMBINE OVERLAP SECTION KIT - TIGER SHARK

Fits JOHN DEERE 600 SERIES HEADERS. Includes 5 countersunk sections, 1 overlap rectangle plate, 12 6MM CTSK bolts, 12 6MM nuts.

Order No	List
S20-4012	53.85

### WHY TRY TIGER SHARK™ SECTIONS?

1. Serrated teeth allow more cutting surface.
2. They last longer, cut faster.
3. Cuts equally well in soybeans, alfalfa, grass hay, wheat, etc.



### Customer Testimonial:

"I cut over 1000 acres of soybeans with the same Herschel Tiger Shark™ sections. They stayed sharper longer and lasted longer than any section I have used." - Roger Woodruff, Warren Co. Iowa

### UNIVERSAL END SECTIONS

HERSCHEL "End Sections" are made of one-piece high carbon, heat-treated steel for rugged use. They are punched with an oblong hole to virtually fit any standard cutterbar mower in use today. To install our "End Section", simply take off the last section on the shoe end of your sickle assembly and replace it with an "End Section". The change-over takes only a couple of minutes to complete and you will notice a big difference in time saved from unclogging your mower. We recommend using a R36-0523D oval head rivets or B55-0065D Bolts.



Description	Order No	List	Description	Order No	List
XH7TSCR (RH) 10/Box	S20-4403	38.49	Tiger Shark™ (LH) 2/SP	S20-8445D	12.06
XH7TSCR (RH) 2/SP	S20-4403D	10.54	XHTS CR (RH) 10/Box	S20-4210	38.49
Tiger Shark™ (RH) 10/Box	S20-8403	45.13	XHTS CR (RH) 2/SP	S20-4210D	10.54
Tiger Shark™ (RH) 2/SP	S20-8403D	12.06	XHTSCR (LH) 10/Box	S20-4211	38.49
XH7TSCR (LH) 10/Box	S20-4445	41.22	XHTSCR (LH) 2/SP	S20-4211D	10.54
XH7TSCR (LH) 2/SP	S20-4445D	13.94	XHUSCR (RH) 10/Box	S20-6640	40.77
Tiger Shark™ (LH) 10/Box	S20-8445	45.13	XHUSCR (RH) 2/SP	S20-6640D	10.54

S20-8445



## 1-YEAR WARRANTY ON ALL ITEMS!

## SECTION BOLTS

Description	Application	Qty. Pkg.	Qty. Mstr Ctn.	Order No.	List
Section Bolt w/Nut	Universal - Replaces 9/16" & 5/8" OH Rivets	50	300	B55-0065D	9.55
Section Bolt w/Nut	600 Series Flex & Rigid Headers M6-1.0x16	50		B55-0075D*	23.53
Head Strap Bolt	600 Series Flex & Rigid Headers M6-1.0x20	11		B55-0076D*	16.55
Head Section Bolt w/Nut	600 Series Flex & Rigid Headers M6-1.0x25	9		B55-0077D*	17.35
Splice Bolt & Nut	600 Series Flex & Rigid Headers	20		B55-0078D*	9.64
Assortment of Head Bolts	600 Series Flex & Rigid Headers. (6) 20 mm & (6) 25 mm	12		B55-0080D*	18.73
Head Bolt w/Nut	Universal - Replaces 1" & 1-1/16" OH Rivets	15	90	B55-0085D	5.85
Head Bolt w/Nut	Universal - Replaces 1-1/4" OH Rivets	12	72	B55-0095D	6.02
Section Bolt w/Nut	Universal - Bolts for 10' Sickles w/head bolts (80 -B55-0065D, 5 - B55-0085D, 5-B55-0095D)	90	Each	B55-0500D	22.76
Head Bolt w/Oval Shank	600, 700 (15 - 20 mm bolts & nuts, 10 - 25mm bolts & nuts) H158342 AND H158343.	25		B55-0601D**	44.14
Section Bolt W/Oval Shank	600, 700 Series Flex & Rigid Headers. H158341, H158343.	50		B55-0600D**	43.47
Overlap Bolt/Nut	600, 700 Series Flex & Rigid Headers.	10		B55-0602D	5.66
1/2" CS Overlap Bolt w/Low Profile Nut	Double Drive Hay Sickles (use with Allen Wrench)	10	60	B55-0059D	7.06
Nut, Full	Universal for all above bolts	20	120	N83-0289D	5.36
Nut, Low Profile	Overlap Hay	20	120	N83-0295D	5.45

\*For sickles using ribbed shoulder section bolts. \*\*For sickles using oval shoulder section bolts.



## RIVETS

Size / No. in Pkg.	Description	Application	Qty. Pkg.	Qty. Ctn.	Order No.	List
5/8" # 5-1/2 (56)	OH Rivets Asst.	7" Heavy Mower Sections	Asst.	6	R36-0523D	7.75
1" # 5-1/2 (10)	Zinc Pltd.	and Knife Heads				
5/8" # 5-1/2 (72)	OH Rivets Asst.	9" Mower Conditioners	Asst.	6	R36-0524D	9.39
1" # 5-1/2 (5)	Zinc Pltd.					
1-1/4" # 5-1/2 (5)						
1-1/4" OH	OH Rivets Zinc Plt.	Head Rivet	1/2#	3	R36-0467D	6.83
5/8" OH	OH Rivets Zinc Plt.	Heavy Gauge Sections	1#	6	R36-0462D	13.40
15/16" OH	OH Rivets Zinc Plt.	Head Rivet	1/2#	3	R36-0522D	6.32
1-1/4" CS	CS Rivets Zinc Plt.	Guard Plate Rivet	1/2#	3	R36-0468D	6.63
5/8" CS	CS Rivets Zinc Plt.	Section Rivet	1#	6	R36-0463D	10.94



## HOLD DOWN CLIPS NON-ADJUSTABLE

Fits JOHN DEERE Mowers. Steel.

Style	Order No.	List
High Arch	C45-0042	6.59



Fits all JOHN DEERE Combines and Mowers. Steel.

Style	Order No.	List
Low Arch	C45-0692	3.57
High Arch	C45-0693	4.79

## HOLD DOWN CLIPS ADJUSTABLE



Fits all JOHN DEERE Mowers, Windrowers, & Swathers. Cast.

Style	Order No.	List
Low Arch	C45-0006	21.39
High Arch	C45-0007	21.39

Fits most JOHN DEERE Combines, Mowers & Windrowers. Steel.

Style	Order No.	List
Low Arch	C45-0040	5.65



5.65fits most JOHN DEERE 600, 700 Series. Cast.

Replaces	Style	Order No.	List
AH218547	Low Arch	C45-0620	6.83
AH218548	High Arch	C45-0625	8.28

SICKLES

MOWERS 2, 5, 7B, 7D, 8, 8W, 9, 9W, 11, 20A, 37, 38, 39, 39N, 51

OEM #	Length	No. Of Sections	Head	Head OEM #	Type	Section	Section OEM #	Riveted Order No	Riveted List	Bolted Order No	Bolted List
AZ958H, AZ3987H	7'	28	H15-0282	AZ955H, H28076	XHSM	S20-1142	E76372, Z6451H	S35-3725	146.40	-	-
AZ1299H	7'	28	H15-0282	AZ955H, H28076	XHUS	S20-5246	E76373, Z7030H	S35-3548	133.99	S35-1288	179.78
AZ3987H	9'	36	H15-0282	AZ955H, H28076	XHSM	S20-1142	E76372, Z6451H	S35-3587	188.42	-	-
AZ3988H	9'	36	H15-0282	AZ955H, H28076	XHUS	S20-5246	E76373, Z7030H	S35-3588	162.75	-	-

MOWERS 47, 50, 250, 350, 450, 3700 WITH NEEDLE BEARING STYLE HEAD

OEM #	Length	No. Of Sections	Head	Head OEM #	Type	Section	Section OEM #	Riveted Order No	Riveted List	Bolted Order No	Bolted List
AE48592, AE36097	7'	28	H15-0335	AE35450, AE47891, AE48587	XHUS	S20-5246	E76373, Z7030H	S35-3004	172.13	-	-
AE48593, AE36101	7'	28	H15-0335	AE35450, AE47891, AE48587	XHSM	S20-1142	E76372, Z6451H	S35-3001	226.10	-	-
SSAE48593, SSAE36101	7'	28	H15-0335	AE35450, AE47891, AE48587	XH7TSCR	S20-4286	SSE45996, SSE76370	-	-	S35-2455	238.75
AE48594, AE36102	9'	36	H15-0335	AE35450, AE47891, AE48587	XHUS	S20-5246	E76373, Z7030H	S35-3003	199.55	S35-1709	240.93
AE48594, AE36102	9'	36	H15-0335	AE35450, AE47891, AE48587	XHTS	S20-3996	E76370, E45996	S35-3005	240.52	-	-

MOWER CONDITIONERS 480, 483, 485, 780, 800 BOTH WITH 78 DRAPER HEADER, 1209 S/N 285000-EARLIER, 2280, 2320, 2420 ALL THREE WITH 240 AUGER HEADER TIE ROD HEAD STYLE

OEM #	Length	No. Of Sections	Head	Head OEM #	Type	Section	Section OEM #	Riveted Order No	Riveted List	Bolted Order No	Bolted List
AE27602	9'	37	Headless	AE24247	XHTSCR	S20-4777	E45996, E76370	S35-4354	283.27	-	-
AE27623	9'	37	Headless	AE24247	XHUSCR	S20-6344	E76371, H21530H	S35-4353	221.22	-	-

WINDROWERS 780, 800, 830, 880, 1214, 2250, 2270 USING PLATFORMS 78, 88, 120, 183, 188, 220, 278, 288 TIE ROD HEAD STYLE

OEM #	Length	No. Of Sections	Head	Head OEM #	Type	Section	Section OEM #	Riveted Order No	Riveted List	Bolted Order No	Bolted List
AE28067	12'	49	Headless	AE24247	XHTSCR	S20-4777	E45996, E76370	S35-4350	374.95	-	-
AE28073	14'	57	Headless	AE24247	XHTSCR	S20-4777	E45996, E76370	S35-4351	330.61	-	-
AE23898, AE30976	15'	59	Headless	AE24247	XHTSCR	S20-4777	E45996, E76370	S35-4751	398.58	-	-

WINDROWERS 4890 DOUBLE DRIVE, 4895, 4995 SELF- PROPELLED USING 890, 895, 896 AUGER PLATFORMS

OEM #	Length	No. Of Sections	Head	Head OEM #	Type	Section	Section OEM #	Riveted Order No	Riveted List	Bolted Order No	Bolted List
AE51995, AE57037	14' LH	29	H15-0417	AE54468	XH7TSCR	S20-4286	SSE45996, SSE76370	-	-	S35-2330	234.47
AE51996, AE57038	14' RH	29	H15-0417	AE54468	XH7TSCR	S20-4286	SSE45996, SSE76370	-	-	S35-2332	234.46
AE51795, AE57039	16' LH	33	H15-0417	AE54468	XH7TSCR	S20-4286	SSE45996, Tiger Shark™ S20-8286 SSE76370	-	-	S35-2331	263.83
AE51796, AE57040	16' RH	33	H15-0417	AE54468	XH7TSCR	S20-4286	SSE45996, Tiger Shark™ S20-8286 SSE76370	-	-	S35-2334	263.83
AE51997, AE57041	18' LH	37	H15-0417	AE54468	XH7TSCR	S20-4286	SSE45996, SSE76370	-	-	S35-2333	263.71
AE51998, AE57042	18' RH	37	H15-0417	AE54468	XH7TSCR	S20-4286	SSE45996	-	-	S35-2335	263.71

WINDROWERS 1207, 1209 S/N 285000-LATER, 1217, 1219

OEM #	Length	No. Of Sections	Head	Head OEM #	Type	Section	Section OEM #	Riveted Order No	Riveted List	Bolted Order No	Bolted List
AE34769, AE41758, AE48664	9'	37	H15-0362* Riveted H15-0786* Bolted	AE48125	XHTSCR	S20-4777	E76370, E45996	S35-4873	216.08	-	-
AE41703, AE48662	9'	37		AE48125	XHUSCR	S20-6344	E76371, H21530H	S35-4868	200.65	S35-2012	236.80
										S35-2526	205.47
										S35-2936	246.85

**SICKLES**

**WINDROWERS 2280, 2320, 2420 USING 230, 240 AUGER PLATFORM OR 130, 135 DRAPER HEADER**

OEM #	Length	No. Of Sections	Head	Head OEM #	Type	Section	Section OEM #	Riveted Order No	Riveted List	Bolted Order No	Bolted List
SSAE34769, SSAE41758 SSAE48664	9'	37	H15-0786*	AE48125	XH7TSCR	S20-4286	SSE45996, SSE76370	-		S35-2012	236.80
AE34769, AE41758 AE48664	9'	37	H15-0362*	AE48125	XHTSCR	S20-4777	E76370, E45996	S35-4873	216.08	-	
AE41703, AE48662	9'	37	H15-0362* Riveted H15-0786* Bolted	AE48125	XHUSCR	S20-6344	E76371, H21530H	S35-4868	200.65	S35-2936	246.85
SSAE34769, SSAE1758 SSAE48664	9'	37	H15-0786*	AE48125	XH7TSCR	S20-4286	SSE45996, SSE76370	-		S35-2012	236.80
AE35791, AE48652	12'	49	H15-0362* Riveted H15-0786* Bolted	AE48125	XHTSCR	S20-4777	E76370, E45996	S35-4133	354.81	S35-2290	336.25
AE35809, AE48654	14'	57	H15-0362* Riveted H15-0786* Bolted	AE48125	XHTSCR	S20-4777	E76370, E45996	S35-4131	309.12	S35-2711	392.93
AE35846, AE48657	16'	65	H15-0362*	AE48125	XHTSCR	S20-4777	E76370, E45996	S35-4132	398.00	-	
SSAE35846, SSAE48657	16'	65	H15-0786*	AE48125	XH7TSCR	S20-4286	SSE45996, SSE76370	-		S35-2460	434.20
SSAE31931, SSAE48599	18'	71	H15-0786*	AE48125	XH7TSCR	S20-4286	SSE45996, SSE76370	-		S35-2461	451.12
SSAE28115, SSAE48598	21'	83	H15-0786*	AE48125	XH7TSCR	S20-4286	SSE45996, SSE76370	-		S35-2462	513.87

**MOWER CONDITIONERS 1380 MID-PIVOT HYDRO SHIFT, 1424**

OEM #	Length	No. Of Sections	Head	Head OEM #	Type	Section	Section OEM #	Riveted Order No	Riveted List	Bolted Order No	Bolted List
AE35791, AE48652	12'	49	H15-0362* Riveted H15-0786* Bolted	AE48125	XHTSCR	S20-4777	E76370, E45996	S35-4133	354.81	S35-2290	336.25
AE35809, AE48654	14'	57	H15-0362* Riveted H15-0786* Bolted	AE48125	XHTSCR	S20-4777	E76370, E45996	S35-4131	309.12	S35-2711	392.93

**MOWER CONDITIONERS 1525, 3430, 3830 ALL USING 300 TWIN KNIFE HEAD, 1600, 1600A BOTH USING 300 AUGER PLATFORM**

OEM #	Length	No. Of Sections	Head	Head OEM #	Type	Section	Section OEM #	Riveted Order No	Riveted List	Bolted Order No	Bolted List
AE43511, AE48135	14' RH	28	H15-0363*	AE48126	XHTSCR	S20-4777	E76370, E45996	S35-4138	254.05	-	
SSAE43511, SSAE48135	14' RH	28	H15-0787*	AE48126	XH7TSCR	S20-4286	SSE45996, SSE76370	-		S35-2300	266.72
AE43520, AE48131	14' LH	29	H15-0362*	AE48125	XHTSCR	S20-4777	E76370, E45996	S35-4139	336.08	-	
SSAE43520, SSAE48131	14' LH	29	H15-0786*	AE48125	XH7TSCR	S20-4286	SSE45996, SSE76370	-		S35-2301	266.72
SSAE43510, SSAE48134	16' RH	32	H15-0787*	AE48126	XH7TSCR	S20-4286	SSE45996, SSE76370	-		S35-2021	260.50
AE43519, AE48130	16' LH	33	H15-0362*	AE48125	XHTSCR	S20-4777	E76370, E45996	S35-4141	367.70	-	
SSAE43519, SSAE48130	16' LH	33	H15-0786*	AE48125	XH7TSCR	S20-4286	SSE45996, SSE76370	-		S35-2020	260.50
SSTTAE43511, SSTTAE48135	14' RH	28	H15-0789*	TTAE48125	XH7TSCR	S20-4414	SSTTE45996, SSTTE76370	-		S35-2391	279.89
SSTTAE43520, SSTTAE48131	14' LH	30	H15-0788*	TTAE48125	XH7TSCR	S20-4414	SSTTE45996,	-		S35-2390	279.88

**MOWER CONDITIONERS 710, 720, 820**

OEM #	Length	No. Of Sections	Head	Head OEM #	Type	Section	Section OEM #	Riveted Order No	Riveted List	Bolted Order No	Bolted List
SSAE49203	9' 9"	39	H15-0406	AE49854	XH7TSCR	S20-4286	SSE45996,	-		S35-2270	242.58



SICKLES

WINDROWERS 580, 590 PULL-TYPE, 2360 USING 160 DRAPER HEADER

OEM #	Length	No. Of Sections	Head	Head OEM #	Type	Section	Section OEM #	Riveted Order No	Riveted List	Bolted Order No	Bolted List
SSAW20651, SSCXM15191 SSCXM38634	18'	71	Headless	-	XH7TSCR	S20-4398	SS34390CR	-		S35-2262	354.08
SSAW20652, SSAW25030 SSCXM43074 SSCXM49667	21'	83	Headless	-	XH7TSCR Tiger Shark™	S20-4398 S20-8398	SS34390CR	-		S35-2253 S35-2553	351.47 278.46
SSAW20653	4'	16	Headless	-	XH7TSCR	S20-4398	SS34390CR	-		S35-2254	182.37
SSAW24760, SSAW24762 SSAW25058	9'	36	Headless	-	XH7TSCR	S20-4398	SS34390CR	-		S35-2255	263.55

COMBINES 3300, 4400, 4420, 6600, 6620, 7700, 7720, 8820 USING 200 SERIES RIGID HEADERS OR 213-230 FLEXHEAD PLATFORM, 9400, 9500, 9600 USING 900 SERIES RIGID HEADERS

OEM #	Length	No. Of Sections	Head	Head OEM #	Type	Section	Section OEM #	Riveted Order No	Riveted List	Bolted Order No	Bolted List
AH121076, AH140382	13'	50	H15-0004	AH121075	XH7TSCR	S20-4267	SSH84415, SSH130478	-		S35-2536	360.90
AH128721	16'	62	H15-0004	AH121075	XH7TSCR	S20-4267	SSH84415, SSH130478	-		S35-2538	385.67
AH121081	20'	78	H15-0004	AH121075	XH7TSCR	S20-4267	SSH84415, SSH130478	-		S35-2540	476.51
AH121085	24'	94	H15-0004	AH121075	XH7TSCR	S20-4267	SSH84415, SSH130478	-		S35-2542	614.87
AH121221	25'	100	H15-0004	AH121075	XH7TSCR	S20-4267	SSH84415, SSH130478	-		S35-2108	555.63
N/A	6' Ext. w/splice	24	Headless	N/A	XH7TSCR	S20-4267	SSH84415, SSH130478	-		S35-2543	139.70

**TIGER SHARK™ SPLICED SICKLES**

For JOHN DEERE COMBINES WITH QUICK-TACH RIGID HEADER, 200 & 900 SERIES FLEX HEADER

\*Ships Via UPS

Size	Order No.	List
20'	S35-8920	350.42
22'	S35-8922	370.17
25'	S35-8925	417.72
30'	S35-8930	512.41



**WHY TRY TIGER SHARK™ SICKLES?**

1. Serrated teeth allow more cutting surface.
2. They last longer, cut faster.
3. Cuts equally well in soybeans, alfalfa, grass hay, wheat, etc.

**Customer Testimonial:**

"I cut over 1000 acres of soybeans with the same *Herschel Tiger Shark™* sections. They stayed sharper longer and lasted longer than any section I have used."  
- Roger Woodruff, Warren Co. Iowa

**SICKLE/KNIFE BACKS**

Fits JOHN DEERE Mowers 5, 8, 9, 11, 37, 38, 39

OEM#	Size	Order No.	List
JD 7	7'	S35-6091	34.54
JD 9	9'	S35-6108	56.54

Get Online With Herschel Parts!

www.HERSCHELPARTS.com

You can shop 24 hours a day. 7 Days A Week!  
We are also on Facebook and Twitter! Check out our pages today and stay up-to-date on all the things going on at Herschel!

### SPLICE KIT

For 2-1/16" hole spacing. Kit contains 2 straps along with the bolts & nuts. For 200, 900 Series headers.



**Order No.** C83-0755  
**List** 22.80

### SPLICE KIT

For 2" hole spacing. Kit contains 2 straps along with the bolts & nuts. Mowers & Mower Conditioners.



**Order No.** C83-0750  
**List** 22.80

### SPLICE KIT

For 600 series Herschel made sickles.



**Order No.** C83-1600  
**List** 22.80

### BOLTS FOR SPLICE KITS

Bolts and nuts for splice kits listed above. 12 each per package.



**Order No.** B55-0049D  
**List** 8.74

### SPLICED SICKLES

Fits JOHN DEERE COMBINES WITH QUICK-TACH RIGID HEADER, 200 & 900 SERIES FLEX HEADER

If Head Required: Order #H15-0395 for Quick-Tach Rigid Headers.

Order #H15-0004 for 200 & 900 Series Flex Headers.

Note: For Sickles 16' or longer, use (1) S78-0005 Reinforcement Strap

#### WITH SUPER 7® CHROME SECTIONS

OEM #	Length	# Of Sections	Cut-Off Section	8' Segment S35-2734	7.5' Head End S35-2733	6' Segment S35-2732	Order No.	List
SPLAH121076	13'	50	4	-	1	1	S35-2735	259.59
SPLAH121077	15'	60	2	1	1	-	S35-2736	299.84
SPLAH128721	16'	62	0	1	1	-	S35-2737	315.23
SPLAH121079	18'	70	8	-	1	2	S35-2738	364.36
SPLAH121081	20'	78	0	-	1	2	S35-2739	290.27
SPLAH121083	22'	86	0	1	1	1	S35-2740	387.01
SPLAH121085	24'	94	0	2	1	-	S35-2741	394.75
SPLAH121221	25'	100	2	-	1	3	S35-2742	345.97
SPLAH121087	30'	120	6	3	1	-	S35-2743	405.98

#### WITH TOP SERRATED 14 TOOTH CHROME SECTIONS

OEM #	Length	# Of Sections	Cut-Off Section	8' Segment S35-2205	7.5' Head End S35-2204	6' Segment S35-2203	Order No.	List
SPLAH125754	20'	78	0	-	1	2	S35-2210	435.78
SPLAH125756	24'	94	0	2	1	-	S35-2212	479.98
SPLAH121221	25'	100	2	-	1	3	S35-2213	531.19
SPLAH121087	30'	120	6	3	1	-	S35-2214	619.08

### JOHN DEERE 600 SERIES FLEX DRAPER SINGLE DRIVE SPLICED SICKLES

Milled splice joints. Oval bolt holes

Segments sized to interchange with JD OE segments

Headless - Order heads seperately

With chrome Super 7 or Tiger Shark sections

Ships via UPS

#### SUPER 7

Model	Description	All S35-5000 Head Seg	All S35-5003 Mid Seg	20 FT S35-4705 Tail Seg	25 FT S35-4706 Tail Seg	30 FT S35-4707 Tail Seg	35 FT S35-4708 Tail Seg	40 FT S35-4709 Tail Seg	Complete Sickle Order No.	List
620 SINGLE DR	JD 620	1	1	1					S35-4663	659.82
625 SINGLE DR	JD 625	1	1		1				S35-4664	765.37
630 SINGLE DR	JD 630	1	2			1			S35-4665	888.24
635 SINGLE DR	JD 635	1	2				1		S35-4666	954.10
640 SINGLE DR	JD 640	1	3					1	S35-4667	1181.71

#### TIGER SHARK

Model	Description	All S35-8004 Head Seg	All S35-8003 Mid Seg	20 FT S35-8015 Tail Seg	25 FT S35-8016 Tail Seg	30 FT S35-8017 Tail Seg	35 FT S35-8018 Tail Seg	40 FT S35-8019 Tail Seg	Complete Sickle Order No.	List
620 SINGLE DR	JD 620	1	1	1					S35-8641	663.13
625 SINGLE DR	JD 625	1	1		1				S35-8642	762.17
630 SINGLE DR	JD 630	1	2			1			S35-8643	886.79
635 SINGLE DR	JD 635	1	2				1		S35-8644	954.90
640 SINGLE DR	JD 640	1	3					1	S35-8645	1179.67

**JD 600, 700 SERIES FLEX DRAPER DOUBLE DRIVE REPLACEMENT PARTS**

Description	OEM #	Order No.	List
Splice Kit, 10-Hole, Tiger Shark™	AH205715TSRK	C83-1601JD	16.54
Splice Kit, 10-Hole, Super 7	AH205715	C83-1600JD	16.54
Head Strap	H156240	S78-0600	26.12
Head Bolts (15) 20MM, (10) 25MM	H158342, H158434	B55-0601D	44.14
Section Bolts 16MM	H158341	B55-0600D	43.47
Section Bolts. C/S For Overlap Sections	12 bolts/nuts	B55-0602D	5.66
Tiger Shark Overlap Kit. Includes sections, slide & hardware		S20-4012	53.85
Super 7 Overlap Kit. Includes sections, slide & hardware		S20-4011	53.85
Top Countersunk Super 7 Section For Overlap. Box of 10		S20-4540	50.99

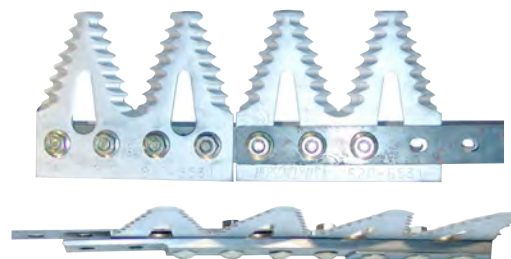

**JOHN DEERE 600, 700 SERIES FLEX DRAPER DOUBLE DRIVE SPLICED SICKLES**

Milled splice joints . Oval bolt holes  
 Segments sized to interchange with JD OE segments  
 Headless - Order heads separately  
 With chrome Super 7 or Tiger Shark sections  
 Ships via UPS

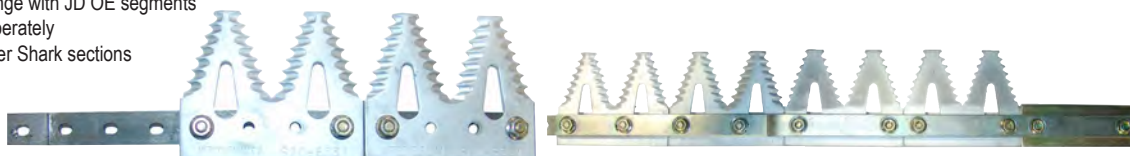

**SUPER 7**

Model	Description	RH Head Seg	LH Head Seg	40 FT Mid Seg	25 FT RH Tail Seg	25 FT LH Tail Seg	30 FT RH Tail Seg	30 FT LH Tail Seg	35 FT RH Tail Seg	35 FT LH Tail Seg	40 FT RH Tail Seg	40 FT LH Tail Seg	PART #	List
25FD DBL DR	JD 25	1	1		1	1							S35-4750	895.02
30FD DBL DR	JD 30	1	1				1	1					S35-4755	988.53
35FD DBL DR	JD 35	1	1						1	1			S35-4759	1082.18
40FD DBL DR	JD 40	1	1	2							1	1	S35-4760	1358.18

**TIGER SHARK**

Model	Description	RH Head Seg	LH Head Seg	40 FT Mid Seg	25 FT RH Tail Seg	25 FT LH Tail Seg	30 FT RH Tail Seg	30 FT LH Tail Seg	35 FT RH Tail Seg	35 FT LH Tail Seg	40 FT RH Tail Seg	40 FT LH Tail Seg	PART #	List
25FD DBL DR	JD 25	1	1		1	1							S35-8750	899.89
30FD DBL DR	JD 30	1	1				1	1					S35-8751	994.06
35FD DBL DR	JD 35	1	1						1	1			S35-8752	1096.41
40FD DBL DR	JD 40	1	1	2							1	1	S35-8753	1364.94



**SICKLE HEAD**

Fits JOHN DEERE Mowers 5, 8, 9, 11, 37, 38, 39, 39N. Replaces H28076.

Order No.	List
H15-0282	74.61



**SICKLE HEAD**

Fits JOHN DEERE Mowers 47, 50, 250, 350, 450, 3700 w/Needle Bearing. Replaces AE48583.

Order No.	List
H15-0335	88.15



**SICKLE HEAD**

Fits JOHN DEERE Mower Conditioner 1207 & 1209 (S/N 28500 & Up), 1217, 1219 Windrower 230,240,1380, 2280, 2320, 2420, 300 Twin Knife Header. Left hand with needle bearing. For bolted sickles ONLY. Replaces AE48125 and AE34328.

Order No.	List
H15-0786	83.81

**SICKLE HEAD**

Fits JOHN DEERE Mower Conditioner 1207 & 1209 (S/N 28500 & Up), 1217, 1219 Windrower 230,240,1380, 2280, 2320, 2420, 300 Twin Knife Header. Left hand with needle bearing. For riveted sickles ONLY. Replaces AE48125.

Order No.	List
H15-0362	82.16

**SICKLE HEAD**

Fits JOHN DEERE Mower conditioner 1207 & 1209 (S/N28500 & Up), 1217, 1219 Windrower 230, 240, 1380, 2280,2320, 2420, 300 Twin Knife Header. Tiger Tooth sickle with needle bearing. Replaces TTAE48125 and TTAE34328.

Order No.	List
H15-0788	89.21

**SICKLE HEAD**

Fits JOHN DEERE Mower conditioner 300 Twin Knife Windrower, 2280, 2320 and 2420 300 Twin Knife Header. Right hand. For bolted sickles ONLY. Replaces AE48126

Order No.	List
H15-0787	85.91



**SICKLE HEAD**

Fits JOHN DEERE 890 & 4890 Double Drive Windrowers. Left hand and right hand. Replaces AE54468.

Order No.	List
H15-0417	88.55

**SICKLE HEAD**

Fits JOHN DEERE 600 Flex Draper Double Drive. LH or RH. Replaces AH231842. Nylon insert.

Order No.	List
H15-0602	89.48

**SICKLE HEAD**

Fits JOHN DEERE 600 Single Drive Head To Convert From 4" to 3". Replaces AH204938. Nylon insert.

Order No.	List
H15-0601	112.56



**SICKLE HEAD**

Fits JOHN DEERE Combine 2000, 2002, 3300, 4400, 6600, 6601, 6602, 7700(Flex), 200 & 900 Series Headers TJ1996 & Newer. Replaces AH 89498, AH121075, KXE10217.

Order No.	List
H15-0004	95.77



**SICKLE HEAD**

Fits JOHN DEERE 600F, 600R. Includes nylon collar. Replaces AH220051.

Order No.	List
H15-0600	139.91

**HEAD REINFORCEMENT STRAP**

For JD 600 series heads.

Order No.	List
S78-0600	26.12

**HEAD REINFORCEMENT STRAP**

Use (1) on 16' or longer, For Combine Sickles Except Tiger Jaw.

Order No.	List
S78-0005	26.12

**HEAD BEARING KIT WITH SNAP RINGS**

Fits JOHN DEERE Combine 200 & 900 Tiger Jaw (Fits H15-0952 Head). Replaces KP12A.

Order No.	List
B15-0659B	31.33

**SICKLE HEAD**

Fits JOHN DEERE 900 Draper. Replaces AH22050.

Order No.	List
H15-0607	120.28



**6" WEAR PLATE**

Fits JOHN DEERE Mowers, Windrowers and Mower Conditioners. Replaces E47954.

Order No.	List
P44-0650	3.42

**NEEDLE AND BEARING SEAL**

Fits H15-0786, H15-0362, H15-0335, H15-0363, H15-0788, H15-0789, H15-0787. Replaces AE78137 and E78721.

Order No.	List
B15-0681B	30.56



**6" WEAR PLATE**

Fits JOHN DEERE 200 & 900 series platforms. Replaces H153157.

Order No.	List
P44-0655	3.20

**HERSCHEL DISC MOWER KNIVES -  
MADE IN THE USA**

- Manufactured in the U.S.A. to meet ISO 5718 standard on Knives for agricultural rotary disc mowers.
- Manufactured from high quality U.S.A. 10B38 (boron) steel.
- Edges are formed not ground to prevent edges from chipping & breakage.
- Entire knife is heat treated to a RC hardness of 45-52. Batch heat treating can cause knives on the inside of the batch to vary greatly in hardness compared to knives on the outside of the batch.
- Each knife is stamped with our name, date and lot number to allow us to trace the manufacturing process on each knife. This allows traceability of the steel back to the steel mill and the mills heat lot of the steel used in the knife.

**DISC MOWER KNIVES**

Fits JOHN DEERE 525, 530, 535, 625, 630, 635, 730, 735, 830, 835, 910, 915, 916, 920, 925, 926, 930, 935, 936, 945, 946, 955, 956, 990, 994, 995, 1340, 1350, 1360, 1460, 1470.

Length: 4.21"      Degree of Twist: 13      Hole Diameter: .72  
Width: 1.78      Thickness: 0.169      Center Of Hole To Back Edge: .80

OEM Number	Style	Shape	Bolt Order No	6 Blades Order No	List	25 Blades Order No	List
E80208	4	RH Twisted	B55-0344D	B45-6568D	9.83	B45-6568	39.24
E80206	4	LH Twisted	B55-0344D	B45-6569D	9.83	B45-6569	39.24



**DISC MOWER KNIVES**

Fits JOHN DEERE 1314, 1315.

Length: 3.66"      Degree of Twist: 13      Hole Diameter: .64  
Width: 1.60      Thickness: 0.116      Center Of Hole To Back Edge: .80

OEM Number	Style	Shape	Bolt Order No	6 Blades Order No	List	25 Blades Order No	List
CC19336	4	LH Twisted	B55-0358D	B45-6996D	10.18	B45-6996	30.57
CC19333	4	RH Twisted	B55-0358D	B45-6997D	10.18	B45-6997	35.62



**DISC MOWER KNIVES**

Fits JOHN DEERE 1320, 1326, 1327, 240, 260

Length: 3.75"      Degree of Twist: 13      Hole Diameter: .64  
Width: 1.78      Thickness: 0.140      Center Of Hole To Back Edge: .75

OEM Number	Style	Shape	Bolt Order No	6 Blades Order No	List	25 Blades Order No	List
CC20500, CC44005	4	LH Twisted	B55-0358D	B45-6122D	9.30	B45-6122	39.41
CC20501, CC44006	4	RH Twisted	B55-0358D	B45-6123D	9.30	B45-6123	39.41



**DISC MOWER KNIVES**

Fits JOHN DEERE 1320, 1326, 1327, 265, 270, 275, 285.

Length: 4.72"      Degree of Twist: 13      Hole Diameter: .73  
Width: 1.79      Thickness: 0.170      Center Of Hole To Back Edge: .78

OEM Number	Style	Shape	Bolt Order No	6 Blades Order No	List	25 Blades Order No	List
CC21780	4	LH Twisted	B55-0358D	B45-6565D	10.41	B45-6565	40.64
CC21781	4	RH Twisted	B55-0358D	B45-6566D	10.41	B45-6566	40.64



## FORGED STEEL GUARD

Fits JOHN DEERE Mower Conditioner & Windrowers 300, 300A prior to sn 943000. Mower Conditioners 1217, 1218 sn 71001 & later; 1600, 4890, 4895 using 890, 895, 896 Auger Platform. Replaces HA222H, FS 96-DH, E72428, H113571. Double Heat Treated.



Order No \_\_\_\_\_ List  
G81-0147 12.02

## FORGED STEEL GUARD

Fits JOHN DEERE Mowers 37, 389, 39, 250, 350, 450. M/C 480, 483, 485. Windrowers 215, 215A, 780, 800, 880. Platform Augers 18, 19, 183, 188, 220 & 230 prior to s/n 425000. Draper platforms 78, 88, 120, 130, 135. Replaces HA220, FS82-2, E48093, E52667, E82559 Up To 1978



Order No \_\_\_\_\_ List  
G81-0185 14.12

## FORGED STEEL GUARD

Fits JOHN DEERE Windrowers 580, 590; 140, 160 Augers. Replaces HA215DH, FS81DH. Double heat treated.



Order No \_\_\_\_\_ List  
G81-0155 9.37  
G81-0098 - Double Heat Treat 11.23  
G81-0231 - Boron 11.23

## FORGED STEEL GUARD

Fits JOHN DEERE Model 580, 590, 140 Auger. 160 Draper. Replaces HA235, FS73-2, W30341.



Order No \_\_\_\_\_ List  
G81-0070 13.96

## FORGED STEEL GUARD

Fits JOHN DEERE Quick Tach 200, 900 Series. Replaces HA240S and H145791.



Order No \_\_\_\_\_ List  
G81-0021 14.17

## FORGED STEEL GUARD

Fits JOHN DEERE 600F, 600FD, 700FD. Replaces H229537. Double Heat Treat. 610DH. Long-Short-Long.



Order No \_\_\_\_\_ List  
G81-0537 11.76  
G81-0537G\* 21.33  
\*German Made

## FORGED STEEL GUARD

Fits JOHN DEERE 600F, 600FD, 700FD. Replaces H229538. Double Heat Treat. 615DH. Short-Long-Short.



Order No \_\_\_\_\_ List  
G81-0538 11.76  
G81-0538G\* 21.33  
\*German Made

## FORGED STEEL GUARD

Fits JOHN DEERE 600 Series Rigid & Draper Heads. 900 Series Draper Heads. Replaces HA635, H213405. Long-Short-Long.



Order No \_\_\_\_\_ List  
G81-0396 15.10

## FORGED STEEL GUARD

Fits JOHN DEERE 600 Series Rigid & Draper Heads. 900 Series Draper Heads. Replaces HA630, H213408. Short-Long-Short.



Order No \_\_\_\_\_ List  
G81-0397 15.33

## FORGED STEEL GUARD

Fits JOHN DEERE combines. Replaces HA240A, FC 62-2A, H145791, H75386, H61954H.



Order No \_\_\_\_\_ List  
G81-0191 8.79

## FORGED STEEL GUARD

Fits JOHN DEERE Mower Conditioners - 710, 720, 820, 830, 1600A. Auger Platforms - 300A s/n 943001 and later; 890. Replaces E81300 and E88909.



Order No \_\_\_\_\_ List  
G81-0223 19.12

## FORGED STEEL GUARD

Fits JOHN DEERE M/C 1207, 1209, 1214, 1217, 1219, 1380, 1600, 1424, 1525. Mowers 350, 450. Replaces HA254, HA254H, E59625, E52547, E57752, E95625. Non-clog, double heat treated.



Order No \_\_\_\_\_ List  
G81-0102 15.86

## FORGED STEEL GUARD

Fits JOHN DEERE 600, 700 Series Flex Heads. Replaces HA610, H213507, H20547, H213400. Long-Short-Long.



Order No \_\_\_\_\_ List  
G81-0398 15.32

## FORGED STEEL GUARD

Fits JOHN DEERE 600, 700 Series Flex Heads. Replaces HA615, H205448, H213398. Short-Long-Short.



Order No \_\_\_\_\_ List  
G81-0399 15.32

## FORGED STEEL GUARD

Fits JOHN DEERE combines. Replaces HA340, FC 62-3G, H25603, H153855.



Order No \_\_\_\_\_ List  
G81-0026 22.93

## FORGED STEEL GUARDS

Fits all TIGER JAWS.



Replaces	Description	Order No	List
TJ44-4A	4 Prong	G81-0581	20.67
TJ44-6A	6 Prong	G81-0446	46.42

## MALLEABLE GUARDS

Fits JOHN DEERE MOWERS.



Replaces	Description	Order No	List
DM700, AZ 3441H, AZ 2131H	Center Guard	G81-0803	7.05
DM700-R, AZ 3442H, AZ 2132H	Outer Guard	G81-0805	9.95

## CONICAL GUARD BOLT NUT

Package includes 5, 7/16" nuts.



Order No \_\_\_\_\_ List  
N83-0593D 3.29

## GUARD PLATE

Fits JOHN DEERE Mowers with AZ3441 guard. Replaces Z5110H. 10/box



Order No. \_\_\_\_\_ List  
P44-0646 19.36



**PITMAN WOOD - 26-3/4"**

Fits JOHN DEERE Mowers 8, 9. Replaces Z9913H, AZ12878H, AH16427H.

Order No.	List
P38-0515	26.87



**PITMAN WOOD - 33-15/16"**

Fits JOHN DEERE Mowers 5, 20, 20A. Replaces Z9298H, AZ2497H, AZ2956H, A23419H.

Order No.	List
P38-0510	31.87



**PITMAN WOOD - 36-3/4"**

Fits JOHN DEERE Mowers 8W, 9W, 37, 38, 39, 11. Replaces H28286H, AH16427H.

Order No.	List
P38-0505	40.61

- PATENTED 2 PIECE DESIGN.
- SAVE MONEY!  
REPLACE ONLY THE TINE.



**HERSCHEL 6" 2-PIECE POLY TINES FOR PIPE REELS**

Fits JOHN DEERE 900 F & R series s/n 685101 an up, 600 series. 1/2" diameter nub.

Description	Qty.	Order No.	List
Tine & Clamp	100/Box	T16-0740	198.88
Tine & Clamp	10/Box	T16-0745	21.80
Tine ONLY	100/Box	T16-0750	130.64



MADE IN THE USA



**BALER TOOTH**

For JOHN DEERE Balers 14T, 24T, 214T, 214W. Replaces 276SE.

Order No.	List
T16-0022	3.20



**BALER TOOTH**

For JOHN DEERE Balers 327, 336, 346, 337, 347, 367. Replaces E41833.

Order No.	List
T16-0024	2.76



**BALER TOOTH**

For JOHN DEERE Balers 410, 430, 500, 510, 550. Replaces E61295, E67036.

Order No.	List
T16-0025	2.47



**COMBINE FLEX TINE**

For Front side of wood bats. Replaces N66A. 1 mounts to front of bat. 100 per box.

Order No.	List
T16-0183	189.12



**COMBINE FLEX TINE**

For Rear side of tear drop bats. Replaces N67A. 1 mounts to rear of bat. 100 per box.

Order No.	List
T16-0767	165.82



**COMBINE 2 PIECE M/L REEL TINE**

For Most Pipe Style Reels with 4" bat. Replaces 782551, 1989438C1, AH136689, AH153175. Includes clamps. 100 per box. 3/8" diameter nub.

Order No.	List
T16-0720	175.64



**COMBINE 2 PIECE M/L REEL TINE**

For Most Pipe Style Reels with 4" bat. Replaces 782226, 1989438C1, AH136689, AH153175. Includes clamps. 10 per bag. 3/8" diameter nub.

Order No.	List
T16-0715	19.03



**COMBINE M/L REEL TINE**

For T16-0715 and T16-0720. No clamps. Replaces HA100MLT. Tine only, no clamps. 100 per box. 3/8" diameter nub.

Order No.	List
T16-0725	128.83



**COMBINE PICKUP REEL**

For JOHN DEERE 200 Series platform w/Hume reel. Replaces H1611. Steel. 100 per box.

Order No.	List
T16-0124	1.60



**RAKE TOOTH**

For JOHN DEERE Rakes 567. Replaces E 35277.

Order No.	List
T16-0315	5.37

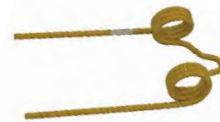

**RAKE TOOTH**

For JOHN DEERE Mower Conditioners 1207, 1209, 1217, 1219, 1380 & AE68906 After SN 425000. Replaces E10711, AE68906.

Order No.	List
T16-0332	3.80



**RAKE TOOTH**

For JOHN DEERE Rakes 553, 594, 594 LW Quick Detach. Replaces 186SE, 175SE. Spring.

Order No.	List
T16-0320	4.07



**RAKE TOOTH**

For JOHN DEERE Rakes 14, 596, 597, 714 Quick Detach. Replaces 194SE.

Order No.	List
T16-0325	3.74



**RUBBER MOUNT RAKE TOOTH**

For JOHN DEERE Rakes 640, 650, 660, 670, 672, 662, 652, 896A. Replaces 1/4 x 3/4 LPK, RMT-1, AE47389. Right hand.

Order No.	List
T16-0182	2.07



**RUBBER MOUNT RAKE TOOTH**

For JOHN DEERE Twin Rake 700, 705. Replaces EF2888001, AE56204. Right/Left hand.

Order No.	List
T16-0185	3.65



**RUBBER MOUNT RAKE TOOTH**

For JOHN DEERE Rakes 640, 650, 660, 670, 672, 662, 652, 896A. Replaces AE47389. Left hand. Torsion

Order No.	List
T16-0188	4.37



**RAKE/BALER TOOTH**

For JOHN DEERE Rakes 851, 894, 350, 858 & 896, 350. Balers 24T, 216T. Replaces 257SE.

Order No.	List
T16-0330	2.32

## RAKE WHEELS

Heavy Duty, .276" (7mm).  
Fits Tonutti/National/Walton,  
John Deere/Frontier, Vermeer,  
Kuhn, Miller Pro/Arts Way, Gehl.  
Painted Black

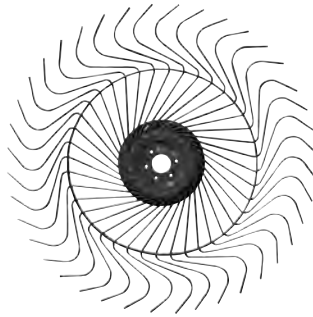

Description	Order No	List
Right Hand. P20BG003	W16-0805	111.98
Left Hand. P20BG004	W16-0806	111.98

Replacement Tine: T16-0497.

## RAKE WHEELS

Heavy Duty, .276" (7mm).  
Fits Tonutti/National/Walton,  
John Deere/Frontier, Vermeer,  
Kuhn, Miller Pro/Arts Way, Gehl.  
Painted Creme

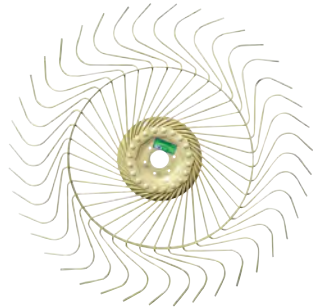

Description	Order No	List
Right Hand. P20BG003	W16-0811	111.98
Left Hand. P20BG004	W16-0812	111.98

Replacement Tine: T16-0497.



**GATHERING CHAIN  
DRIVE SPROCKET**  
For JOHN DEERE 40  
Series to S/N 466450.  
Replaces AN102448,  
Sealed.

Order No	List
S62-0741	24.18



**GATHERING CHAIN  
ILDR SPROCKET**  
For JOHN DEERE 40  
Series to S/N 466451  
and up. Replaces  
AH101219, Relube.

Order No	List
S62-0744	25.73

## HAMMER RIVETS - LARGE HEAD

The R36-0653 Hammer rivet is designed for use of the John Deere 900 series heads with predrilled holes, and can be used in place of the B55-0004 Torque Bolts.



Size	Application	Qty.	Order No.	List
1/4" x 5/16"	JD 900Series-End Plate P44-1126 & Wobble box Plate P44-1127	20/BB	R36-0654	5.92

## PLASTIC BEARING KIT

Includes 12 bearing halves, 6 bolts,  
and 6 nuts.

Application: Pipe Reels with Plastic  
Tines used on JOHN DEERE 900  
series S/N 645300 an up.



Order No.	List
B15-0925	24.64

## PLASTIC BEARING KIT

Includes 6 caps, 6 bases, U-Bolts and  
12 nuts.

Application: Reels with Wood Bats  
used on JOHN DEERE QUICK-TACH  
& 200 series, Tear drop bats used on  
900 series prior to S/N 645300.



Order No.	List
B15-0915	27.47

## CORN HEAD ROLLERS

40 Series Head. Hard-faced



Replaces	Description	Order No	List
H104090	RH	R57-0090	90.52

## GATHERER BELT CHAIN (2 PER ROW)

Replaces AH101172. For 50A Series Row Crop  
Header and 2 Row Forage Harvesters.

Order No	List
B22-0060	129.90

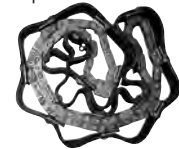

## ROW CROP SECTION

Fits JOHN DEERE 50 Series Row Crop  
Header. Replaces H101607. Sold 12 sec-  
tions per pack. \*36 nuts/bolt per package.

Description	Order No	List
Section	S20-1976	96.41
Bolt/Nut	B55-0977D*	19.53



## HAMMER RIVET TOOL







For Drive Rivets

Order No.	List
T55-0812	30.72





**BALER PARTS**

 <p><b>LOWER DRIVE ROLLER SPROCKET</b> Round Balers 330, 335, 375, 385, 430, 435, 449, 459, 530, 535, 540, 545, 550, 559, 569. Replaces AE39652.</p> <p>20/40 Tooth, 60 Chain, 1.504" Bore</p> <table border="0"> <tr> <td><b>Order No.</b></td> <td><b>List</b></td> </tr> <tr> <td>HAE39652</td> <td>110.38</td> </tr> </table>	<b>Order No.</b>	<b>List</b>	HAE39652	110.38	 <p><b>STARTER ROLLER SPROCKET</b> Round Balers 446, 447, 449, 456, 457, 459, 466, 467, 468, 546, 547, 556, 557, 559, 566, 567, 568, 569. Replaces AE54301, AFH205816.</p> <p>24 Tooth, 60 Chain, 1.504" Bore</p> <table border="0"> <tr> <td><b>Order No.</b></td> <td><b>List</b></td> </tr> <tr> <td>HAE54301</td> <td>55.10</td> </tr> </table>	<b>Order No.</b>	<b>List</b>	HAE54301	55.10	 <p><b>LOWER DRIVE ROLLER SPROCKET</b> Round Balers 446, 447, 449, 456, 457, 459, 466, 467, 468, 546, 547, 556, 557, 559, 566, 567, 568. Replaces AE54302, AFH205819.</p> <p>40/24 Tooth, 60 Chain, 1.504" Bore</p> <table border="0"> <tr> <td><b>Order No.</b></td> <td><b>List</b></td> </tr> <tr> <td>HAE54302</td> <td>110.23</td> </tr> </table>	<b>Order No.</b>	<b>List</b>	HAE54302	110.23	 <p><b>DRIVE SPROCKET FOR STANDARD PICKUP</b> Round Balers 447, 448, 449, 457, 458, 458S, 459, 467, 468, 468S, 469, 547, 567, 557, 558, 559, 568, 569. Replaces AE58632, AFH205822.</p> <p>40 Tooth, 50 Chain, 1.253" Bore</p> <table border="0"> <tr> <td><b>Order No.</b></td> <td><b>List</b></td> </tr> <tr> <td>HAE58632</td> <td>46.31</td> </tr> </table>	<b>Order No.</b>	<b>List</b>	HAE58632	46.31
<b>Order No.</b>	<b>List</b>																		
HAE39652	110.38																		
<b>Order No.</b>	<b>List</b>																		
HAE54301	55.10																		
<b>Order No.</b>	<b>List</b>																		
HAE54302	110.23																		
<b>Order No.</b>	<b>List</b>																		
HAE58632	46.31																		
		 <p><b>SLIP CLUTCH SPROCKET FOR STANDARD PICKUP</b> Round Balers 447, 448, 457, 458, 458s, 467, 468, 468s, 547, 567, 557, 558, 568. Replaces E96714, E131608.</p> <p>38 Tooth, 50 Chain, 2.625" Bore, 4 Bolt, 3.307" Bolt Circle</p> <table border="0"> <tr> <td><b>Order No.</b></td> <td><b>List</b></td> </tr> <tr> <td>HE96714</td> <td>31.22</td> </tr> </table>	<b>Order No.</b>	<b>List</b>	HE96714	31.22	 <p><b>UPPER DRIVE ROLLER SPROCKET #80</b> Round Balers 458, 468, 468s, 558, 568. Replaces AE74596.</p> <p>30 Tooth, 80 Chain</p> <table border="0"> <tr> <td><b>Order No.</b></td> <td><b>List</b></td> </tr> <tr> <td>HAE74596</td> <td>92.62</td> </tr> </table>	<b>Order No.</b>	<b>List</b>	HAE74596	92.62								
<b>Order No.</b>	<b>List</b>																		
HE96714	31.22																		
<b>Order No.</b>	<b>List</b>																		
HAE74596	92.62																		

**1-YEAR WARRANTY ON ALL ITEMS!**

**BALER PARTS**



**MAIN DRIVE SPROCKET FROM GEAR BOX #80**

Round Balers 458, 468, 468s, 558, 568. Replaces AE74597.

13/13 Tooth, 80 Chain

<u>Order No.</u>	<u>List</u>
HAE74597	71.66

**HEADER DRIVE SPROCKET #50**

Round Balers 447, 448, 457, 458, 467, 468, 468s, 540, 545, 547, 550, 557, 567, 568. Replaces AE57757.

19 Tooth, 50 Chain, 1.253" Bore

<u>Order No.</u>	<u>List</u>
HAE57757	44.88



**CAM FOLLOWER BEARING FOR PICKUP REEL**

Round Balers 330, 335, 375, 385, 410, 430, 435, 446, 447, 448, 449, 456, 457, 458, 459, 466, 467, 468, 468s, 510, 530, 535, 540, 545, 546, 547, 550, 556, 557, 559, 566, 567, 568, 569. Replaces AE46215, AFH2040000.

.05" Bore

<u>Order No.</u>	<u>List</u>
HAE46215	17.10

**STARTER ROLL, LOWER GATE ROLLER BEARING**

Round Balers 335, 375, 385, 435, 446, 449, 456, 459, 466, 467, 469, 535, 546, 556, 559, 566, 567, 569. Replaces AE40895.

1-1/2" Hex. 3.3456" OD

<u>Order No.</u>	<u>List</u>
HAE4089	18.94



**TOP IDLER & DRIVE ROLLER BEARING**

Round Balers 430, 435, 456, 466, 467, 530, 535, 547, 556, 557, 567. Replaces AE74652, AR54574, AFH206196, AE45208, AE54574, AE45038.

1-1/2" Hex. 3.5433" OD w/Cast 4-Bolt Flange

<u>Order No.</u>	<u>List</u>
HAE74652	76.96

**IDLER, REAR GATE W/O NET WRAP, BELT STAGGERING & ARM ROLLER BEARING**

Round Balers 335, 375, 430, 435, 446, 447, 449, 456, 457, 458, 458S, 459, 466, 467, 468, 468S, 469, 530, 535, 546, 547, 557, 558, 559, 566, 567, 568, 569. Replaces AE46606.

1-1/4" Hex. 3.1496" OD

<u>Order No.</u>	<u>List</u>
HAE46606	18.44

**PICKUP FRAME SUPPORT BEARING**

Round Balers 385, 430, 435, 447, 456, 457, 458, 468, 468S, 530, 535, 567, 568. Replaces JD9313.

1.0" Hex. 2.4409" OD

<u>Order No.</u>	<u>List</u>
HJD9313	11.55

**STARTER & PICKUP DRIVE ROLLER**

Round Balers 3335, 375, 430, 435, 446, 447, 449, 456, 457, 458, 458S, 459, 466, 467, 468, 468S, 469, 530, 535, 546, 547, 557, 558, 559, 566, 567, 568, 569. Replaces JD8338.

1.0" Hex. 2.44" OD

<u>Order No.</u>	<u>List</u>
HJD9338	11.72

**1-YEAR WARRANTY ON ALL ITEMS!**

HERSCHEL sections are made in the USA from high quality boron steel. Heat-treated for long life. Sections are extra heavy (.116") and chrome unless stated otherwise.

### SECTION TYPES

7TS = Super 7® Top Serrated	TT = Tiger Tooth
SM = Smooth	TJ = Tiger Jaw
US = Under Serrated - 14 Tooth	SRK = Tiger Shark™
TS = Top Serrated - 14 Tooth	

### 5' RIVETED SICKLES - XHSM SECTIONS

Section OEM# 49152.

OEM #	# of Sections	Head OEM#	Order No	List
707510	20	Less Head	S35-3023	61.18



### SECTION - XHSM

Bottom countersunk. Section is 3" x 3-1/4". Use 5/8 CS Rivet. Sold 10 sections per pack.

### Replaces

Number	Order No	List
49152	S20-1152	16.36

HERSCHEL sections are made in the USA from high quality boron steel. Heat-treated for long life. Sections are extra heavy (.116") and chrome unless stated otherwise.

## SECTION TYPES

7TS = Super 7<sup>®</sup> Top Serrated      TT = Tiger Tooth  
 SM = Smooth                              TJ = Tiger Jaw  
 US = Under Serrated - 14 Tooth      SRK = Tiger Shark™  
 TS = Top Serrated - 14 Tooth



**SECTION - XHSM**  
 Fits KOSCH Mowers. Section is 3" x 3-1/4". Use 9/16 OH Rivet. Sold 10 sections per pack.

Replaces Number	Order No	List
K164	S20-1145	12.58



**SECTION - XHSMCR**  
 Fits KOSCH Mowers. Section is 3" x 3-1/4". Use 9/16 OH Rivet. Sold 10 sections per pack.

Replaces Number	Order No	List
K164CR	S20-2758	20.44



**SECTION - XHUSCR**  
 Fits KOSCH Mowers. Section is 3" x 3-1/4". Use 9/16 OH Rivet. Sold 10 sections per pack.

Replaces Number	Order No	List
K165CR	S20-6339	13.30



**SECTION - XHTS**  
 Fits KOSCH Mowers. Section is 3" x 3-1/4". Use 9/16 OH Rivet. Sold 10 sections per pack.

Replaces Number	Order No	List
K164CR	S20-3276	10.59



**SECTION - XHUS**  
 Fits KOSCH Mowers. Section is 3" x 3-1/4". Use 9/16 OH Rivet. Sold 10 sections per pack.

Replaces Number	Order No	List
K165	S20-5107	10.58

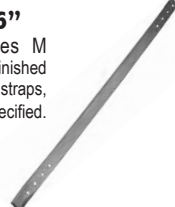

**PITMAN WOOD - 35-11/16"**  
 Fits KOSCH Mowers. Replaces M 222184, K120. Pitman woods are finished and bored BUT do not include separate straps, bolts or boxes. To be used ONLY as specified.

Order No.	List
P38-0535	30.48

**HOLD DOWN CLIPS ADJUSTABLE**



C45-0006      C45-0007

Fits most KOSCH Mowers and Conditioners. Cast.

Style	Order No.	List
Low Arch	C45-0006	21.39
High Arch	C45-0007	21.39

Fits most KOSCH Combines, Mowers and Windrowers except Versatile, Hart-Carter & Love. Stamped

Style	Order No.	List
Low Arch	C45-0040	5.65

**BOLTED SICKLES - XHUS SECTIONS**

Section OEM# K165.

OEM #	Length	# of Sections	Head OEM#	Order No	List
KA436DS	9'			S35-1330*	100.50

\*Special order item - Minimum quantity may be required.



**WEAR PLATE**  
 Center guard. Fits KOSCH Mowers. Replaces K162.

Order No.	List
P44-0417	2.53

**HOLD DOWN CLIP NON-ADJUSTABLE**



Fits KOSCH Mowers and Conditioners. Steel.

Style	Order No.	List
High Arch	C45-0693	4.79

**BOLTED SICKLE - XH7TS SECTIONS - HEADLESS**

Fits KOSCH MOWERS.

Length	Order No	List
7'	S35-1038	94.93
9'	S35-1039	111.45





**Get Online With Herschel Parts!**

**HERSCHELPARTS.com**

**MALLEABLE GUARD**

Center guard. Fits 7/16" Bars. Fits KOSCH Mowers. Replaces MC2041Z, K167.

Order No	List
G81-0830	9.66

S35-3329      S35-3333

**RIVETED SICKLES**

Head OEM# K066A.

OEM #	Length	# of Sections	Head OEM#	Order No	List
KA192	7'	28 - XHUS	K 165	S35-3329	127.24
KA1790	9'	36 - XHUS	K 165	S35-3333	163.30
KA1790	9'	36 - XHTS	826720C2	S35-3018*	192.81

\*Special order item - Minimum quantity may be required.



**SHOE PLATE**  
 Outer guard. Fits KOSCH Mowers. Replaces K163.

Order No.	List
P44-0617	23.11

**GUARD BOLT**

#3 bolt. Replaces 592722R1, M805X. 50 bolts/nuts per package. 7/16" x 1-1/2".

Order No	List
B55-0260	19.95



**GUARD BOLT**

#3 bolt. Replaces K256. 50 bolts/nuts per package. 7/16" x 1-3/4".

Order No	List
B55-0265	22.43



**1-YEAR WARRANTY ON ALL ITEMS!**

HERSCHEL sections are made in the USA from high quality boron steel. Heat-treated for long life. Sections are extra heavy (.116") and chrome unless stated otherwise.

**All MACDON sections have 2-1/8" hole spacing.**

**SECTION TYPES**

- 7TS = Super 7® Top Serrated
- SM = Smooth
- US = Under Serrated - 14 Tooth
- TS = Top Serrated - 14 Tooth
- TT = Tiger Tooth
- TJ = Tiger Jaw
- SRK = Tiger Shark™



**SECTIONS**  
Fits MACDON Windrower 1000, 2000, 3000 & 7000. Section is 3" x 3-1/4". Uses 5/8 OH rivet. Sold 10 sections per pack.

OEM #	Description	Order No	List
16671	XHUS	S20-5236	12.74
22271 CR	XHTSCR	S20-4969	17.11



**SECTION - XHTSCR - F TYPE**  
Fits MACDON 7000 Draper & 960, 962 Header. Section is 3" x 3-1/4". Extra high shoulder. Uses 5/8 OH Rivet. Sold 10 sections per pack.

OEM#	Order No	List
23065	S20-4097	15.15



**SECTION CLIP**  
Replaces 87458207. Used on D50, D60, FD70 & FD75 Headers. Bag of 20.

Order No	List
C45-0050	17.21

**WHY TRY TIGER SHARK™ SECTIONS?**

1. Serrated teeth allow more cutting surface.
2. They last longer, cut faster.
3. Cuts equally well in soybeans, alfalfa, grass hay, wheat, etc.

**Customer Testimonial:**

"I cut over 1000 acres of soybeans with the same *Herschel Tiger Shark™* sections. They stayed sharper longer and lasted longer than any section I have used." - Roger Woodruff, Warren Co. Iowa

**OVERLAP SECTIONS**  
Fits all MACDON Models. Overlap area. Low shoulder. Section is 3" x 3-7/32". Top countersunk holes. Uses 5/8 CS rivet. Sold 10 sections per pack.

OEM #	Description	Order No	List
129319	Tiger Shark™	S20-8399	22.67
34390CR-CS	XH7TSCR-CS	S20-4399	20.71
34390CRTCS	XH7TSCR	S20-4390	20.02



**OVERLAP SECTIONS**  
Fits all MACDON Models. Overlap area. Low shoulder. Section is 3" x 3-7/32". Bottom countersunk holes. Uses 5/8 CS rivet. Sold 10 sections per pack.

OEM #	Description	Order No	List
34390CR.CS	Tiger Shark™	S20-8427	22.67
34390CR.CS	XH7TSCR	S20-4427	20.46

**SECTION OVERLAP KITS**  
Fits MACDON Mowers and Combine heads with double drive sickles. Kit includes 4 Top countersunk sections, 3 bottom countersunk sections and countersunk bolts and nuts.

Description	Order No	List
Tiger Shark™	S20-8009	25.31
XH7TSCR	S20-4009	25.31
XHTSCR	S20-4014	25.31



**SECTIONS**  
Fits MACDON Mowers and conditioners, 912, 922, 933, 960, 962, 963, 972, 973, 974, 4000, D50, D60, FD70, FD75 Headers. Section is 3" x 3-1/4". Uses 5/8 OH rivet. Sold 10 sections per pack. The *Tiger Shark™* section can be used in place of the sections listed below.

OEM #	Description	Order No	List
34390	Tiger Shark™ - Chrome	S20-8398	14.81
34390	Tiger Shark™ - Black	S20-9398	14.26
34390	XH7TSCR	S20-4398	14.10
34390	XHTSCR	S20-4170	16.91
34390	XHTS	S20-3283	12.91

**UNIVERSAL END SECTIONS**  
HERSCHEL "End Sections" are made of one-piece high carbon, heat-treated steel for rugged use. They are punched with an oblong hole to virtually fit any standard cutterbar mower in use today. To install our "End Section", simply take off the last section on the shoe end of your sickle assembly and replace it with an "End Section". The change-over takes only a couple of minutes to complete and you will notice a big difference in time saved from unclogging your mower. We recommend using a R36-0523D oval head rivets or B55-0065D Bolts.

Description	Order No	List
XH7TSCR (RH) 10/Box	S20-4403	38.49
XH7TSCR (RH) 2/SP	S20-4403D	10.54
Tiger Shark™ (RH) 10/Box	S20-8403	45.13
Tiger Shark™ (RH) 2/SP	S20-8403D	12.06
XH7TSCR (LH) 10/Box	S20-4445	41.22
XH7TSCR (LH) 2/SP	S20-4445D	13.94
Tiger Shark™ (LH) 10/Box	S20-8445	45.13
Tiger Shark™ (LH) 2/SP	S20-8445D	12.06
XHTS CR (RH) 10/Box	S20-4210	38.49
XHTS CR (RH) 2/SP	S20-4210D	10.54
XHTSCR (LH) 10/Box	S20-4211	38.49
XHTSCR (LH) 2/SP	S20-4211D	10.54
XHUSCR (RH) 10/Box	S20-6640	40.77
XHUSCR (RH) 2/SP	S20-6640D	10.54

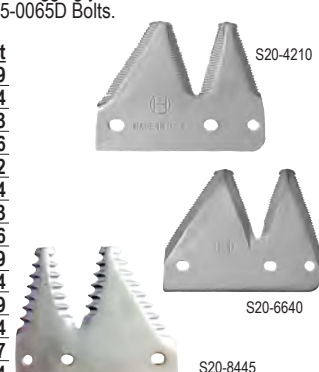

## SECTION BOLTS

- Quick and easy section changes are possible with bolts.
- No more cutting, chiseling, or grinding - simply unbolt the section, replace and tighten bolts.
- Bolts will not turn in Knife Back and are reusable. They will last thru the life of several sections.
- Bolts may be replaced easily if accidentally damaged or broken.
- No special tools are needed to change sections, only a 7/16 wrench or socket.
- Bolt and nuts hold better than rivets and they have a greater clamp load than rivets.
- Special lock nuts will not vibrate loose.

Description	Application	Pkg.	Qty. Mst Ctn.	Order No	List
Section Bolt w/nut	Universal - Replaces 9/16 & 5/8 OH Rivets	50	300	B55-0065D	9.55
Head Bolt w/nut	Universal - Replaces 1-1/2 & 1-1/16 OH Rivets	15	90	B55-0085D	5.85
Head Bolt w/nut	Universal - Replaces 1-1/2 OH Rivets	12	72	B55-0095D	6.02
Section Bolt w/nut	Universal Bolts for 10' Sickle w/Head Bolts (80-B55-0065D, 5-B55-0085D, 5-B55-0095)	90	Each	B55-0500D	22.76
Overlap Bolt w/Low Profile Nut*	Double Drive Sickles, replaces 1/2 CS rivets 60° Head	10	60	B55-0059D	7.06
Nut	Universal-Used on all the above bolts except B55-0050D	20	120	N83-0289D	5.36

\* Use with Allen Wrench



Get Online With Herschel Parts!

# HERSCHELPARTS.com

You can shop 24 hours a day. 7 Days A Week!

We are also on Facebook and Twitter! Check out our pages today and stay up-to-date on all the things going on at Herschel!

### FORGED STEEL GUARD

Fits MACDON 3000, 3020, 4000, 5000, 5010, 5020, 7000, 8000, 9000 series windrowers and mower conditioners' 960, 962, 963, 972, 973, 974, D50, D60, FD70 Drapers; 910, 912, 920, 922, 930, 942, A30S, A30D, A40D Auger Headers. Replaces FS73-2, BU235, 8420, HA235, K84205, K16716-1. **No wear bar.**



Order No	List
G81-0070	13.96

### FORGED STEEL GUARD

Fits MACDON 3000, 3020, 4000, 5000, 5010, 5020, 7000, 8000, 9000 series windrowers and mower conditioners' 960, 962, 963, 972, 973, 974, D50, D60, FD70 Drapers; 910, 912, 920, 922, 930, 942, A30S, A30D, A40D Auger Headers. Replaces HA215M, 23064, 28013, 118344, 118484. Short.



Order No	List
G81-0097	11.50
G81-0097G*	17.57

\*German made

### FORGED STEEL GUARD

Fits MACDON 3000, 3020, 4000, 5000, 5010, 5020, 7000, 8000, 9000 series windrowers and mower conditioners' 960, 962, 963, 972, 973, 974, D50, D60, FD70, FD75 Drapers; 910, 912, 920, 922, 930, 942, A30S, A30D, A40D Auger Headers. Replaces BU215D-HC, 28013, 124338. **Double heat treated. Center guard.**



Order No	List
G81-0093	18.75

### FORGED STEEL GUARD

Fits MACDON 3000, 3020, 4000, 5000, 5010, 5020, 7000, 8000, 9000 series windrowers and mower conditioners' 960, 962, 963, 972, 973, 974, D50, D60, FD70 Drapers; 910, 912, 920, 922, 930, 942, A30S, A30D, A40D Auger Headers. Replaces HA250, FS86-2, 34359. **Stub Guard.**



Order No	List
G81-0120	13.18

### FORGED STEEL GUARD

Fits MACDON 972, D50, D60, D65, FD70, FD75. Left hand overlap guard for double drive heads. 1 used per machine. Replaces 118301.



Order No	List
G81-0092	13.34

### FORGED STEEL GUARD

Fits MACDON 972, D50, D60, D65, FD70, FD75. Right hand overlap guard for double drive heads. 1 used per machine. Replaces 118302.



Order No	List
G81-0096	13.34

### FORGED STEEL GUARD

Fits MACDON 972, D50, D60, D65, FD70, FD75. Guard for drive head areas. 2-6 used per machine. Replaces 118345.



Order No	List
G81-0094	13.34



**WEAR PLATE - 6"**  
Fits MACDON Windrowers.  
Replaces 7382.

Order No.	List
P44-0417	2.53



**SICKLE HEAD - LH**  
Fits MACDON 7000 Auger, 5000, 910, 920, 930, 940. Replaces 34388.

Order No.	List
H15-0132	67.06



**SICKLE HEAD - RH**  
Fits MACDON 7000 Auger, 910, 920, 930, 940. Replaces 34895.

Order No.	List
H15-0133	81.07

**SICKLE HEADS**

FD Series and CNH 2152, 2162 Head

Description	OEM #	Order No.	List
LH Head	132896	H15-0075L	81.66
RH Head	132897	H15-0075R	81.66

**1-YEAR WARRANTY ON ALL ITEMS!**

**BOLTED SICKLES - XHTSCR - HEADLESS**

Fits MACDON 7000 WINDROWERS WITH AUGER HEAD SINGLE DRIVE. JD 2360.

Section OEM# 34390CR.

OEM #	Length	# of Sections	Order No	List
BN34393CR	14'	57	S35-2028	264.95

**BOLTED SICKLES - XHTSCR - HEADLESS**

Fits MACDON 7000 WINDROWERS WITH AUGER HEAD SINGLE DRIVE. JD 2360.

Section OEM# 34390CR.

OEM #	Length	# of Sections	Order No	List
BN33718CR	7' RH	29	S35-2032	187.81
BN33719CR	8' RH	33	S35-2034	224.03
BN33716CR	8' LH	33	S35-2033	224.03

**BOLTED SICKLES - XH7TSCR - HEADLESS**

Section OEM# SS34390CR.

Replaces	Size	Application	Order No	List
36931	9'	4000 9' Single Drive	S35-2257	183.29
34181	12'	5020, 5000, 7000 Auger Header, 12' Single Drive, 912	S35-2258	258.85
34182	14'	5020, 5000, 7000 Auger Header, 14' Single Drive, 912	S35-2259	302.07
34183	16'	5020, 5000, 7000 Auger Header, 16' Single Drive, 912	S35-2260	256.73
33704	18'	7000, 18' Draper Header. Single Drive	S35-2262	354.08
33705	21'	7000, 21' Draper Header, Sgl. Drive, Also Used on 25' & 30' Models	S35-2253	351.47
43076	4' Ext.	7000, 25' Draper Header, Sgl. Drive, Sickle Extn., Use With S35-2253	S35-2254	182.37
43077	9' Ext.	7000, 30' Draper Header, Sgl. Drive, Sickle Extn., Use With S35-2253	S35-2255	263.55
34181	12'	910,912, 920, 922, 930, 12' Single Drive	S35-2258	258.85
34182	14'	910,912, 920, 922, 930, 14' Single Drive	S35-2259	302.07
34183	16'	910,912, 920, 922, 930, 16' Single Drive	S35-2260	256.73
155063	7'RH	910,920,922, 930, 14' 7000 Auger Header, Dbl. Drive w/Std. Guards	S35-2241	118.45
155062	7'LH	910,920,922, 930, 14' 7000 Auger Header, Dbl. Drive w/Std. Guards	S35-2240	119.33
155065	8'RH	910,920,922, 930, 16' 7000 Auger Header, Dbl. Drive w/Std. Guards	S35-2243	130.24
155063	8'LH	910,920,922, 930, 16' 7000 Auger Header, Dbl. Drive w/Std. Guards	S35-2242	147.18
155069	7' LH	932 14' Dbl. Drive, Auger Header, 922, 933	S35-2281	203.68
155064	7' RH	932 14' Dbl. Drive, Auger Header, 922, 933	S35-2282	203.68
38634	18'	940 18' Single Drive	S35-2249	255.59
34211	7'LH	942 15' Double Drive	S35-2240	119.33
155067	9'RH	942 18' Double Drive	S35-2252	186.69
155066	9'LH	942 18' Double Drive	S35-2251	187.92
43074	21'	960, 21', Also used on 25',30' & 36' Models, 962, 963, 3000, 3020	S35-2253	351.47
43076	4' Ext.	960 25' Sickle Extension, Use w/ S35-2253, 962, 963, 3000, 3020	S35-2254	182.37
43077	9' Ext.	960 30' Sickle Extension, Use w/ S35-2253, 962, 963, 3000, 3020	S35-2255	263.55
43078	15' Ext.	960 36' Sickle Extension, Use w/ s35-2253, 962, 963, 3000, 3020	S35-2256	221.11
118443	10.5' LH	972 21' Dbl. Drive	S35-2350	270.08
118395	10.5 RH	972 21' Dbl. Drive	S35-2351	270.08
118441	15' LH	972 30' Dbl. Drive	S35-2357	146.16
118448	15' RH	972 30' Dbl. Drive	S35-2358	146.16
124926	16' RH	D50, D6, Rigid Draper Head. Same as IH 2142 & 2152	S35-2120	166.93
124923	16" LH	FD70 Flex Draper Head. Same as IH 2162. A40D Auger Head	S35-2121	166.93

S35-2259



S35-2262



S35-2243



S35-2242



S35-2350



S35-2120



S35-2121



## SICKLE SPLICE KIT

For Spliced Sickles. 2-1/8" c-c holes. Includes Splice Bar, Bolts, & Nuts. Bolt kit includes 10 csk bolts and nuts.



Replaces	Order No	List
43206	C83-0401	22.45
Bolt Kit	B55-0049D	8.74

## RIVETED SICKLES - XHTSCR - HEADLESS

Fits MACDON WINDROWERS, 2000, HYDRO-MAC.

Head OEM# 20388.

OEM #	Length	# of Sections	Order No	List
18132	25'	100	S35-4928	448.30

## Our Agricultural Background - Cutting Parts

Founded in 1887, by two brothers, Paul E and H. Robert Herschel. R. Herschel Manufacturing quickly became a leader in the sickle section industry.

For more than 130 years HERSCHEL has been an innovator in the cutting parts industry and introduced the chrome plated section (1950), Tiger Jaw® (1981) and Tiger Jaw 2000® (1997) combine conversion kits, Super 7® sections (1992) and most recently the Tiger Shark™ section (2016). Cutting parts designed to provide the agricultural industry with a high quality product at an exceptional value. We are proud to still make our popular cutting products at our factory in Indianola, IA.

## RIVETED SICKLES

Fits MACDON WINDROWERS, 2000, HYDRO-MAC.

Head OEM# 20388.

OEM #	Length	# of Sections	Section#	Order No	List
22258	15'	XHTSCR - 59	22268CR	S35-4737	374.21



## MACDON POLY REEL TINE

Fits most MacDon reels

Order No.	List
H174849	4.81



## WHY TRY TIGER SHARK™ SECTIONS?

1. Serrated teeth allow more cutting surface.
2. They last longer, cut faster.
3. Cuts equally well in soybeans, alfalfa, grass hay, wheat, etc.

## Customer Testimonial:

"I cut over 1000 acres of soybeans with the same *Herschel Tiger Shark™* sections. They stayed sharper longer and lasted longer than any section I have used." - Roger Woodruff, Warren Co. Iowa



## SPLICED COMBINE SICKLES

All sickles are made bolted and headless with extra heavy chrome sections. All segments are less than 108" to ship UPS.

Model	Size	Drive	14-Tooth		Tiger Shark™	
			Order No.	List	Order No.	List
962/963	30	Single	S35-2181	453.32	S35-2879	446.37
	36	Single	S35-2182	559.88	S35-2880	548.01
972	25	Single	S35-2184	357.10	S35-2882	363.24
	30	Single	S35-2181	453.32	S35-2879	446.37
	36	Single	S35-2182	559.88	S35-2880	548.01
	21	Double			S35-2883	378.69
	25	Double	S35-2186	402.84	S35-2884	429.96
	30	Double	S35-2187	444.45	S35-2885	482.94
D50, D60, D65, FD70, FD75	20	Single	S35-2189	306.19	S35-2887	302.72
	25	Single	S35-2184	357.10	S35-2882	363.24
D50, D60, D65, FD70, FD75	30	Single	S35-2181	453.32	S35-2879	446.37
	35	Single	S35-2190	497.69	S35-2888	494.33
	40	Single	S35-2191	607.16	S35-2893	588.73
D50, D60, D65, FD70, FD72	20	Double	S35-2192	353.19	S35-2894	374.15
	25	Double	S35-2193	414.13	S35-2895	433.79
D50, D60, D65, FD70, FD75	30	Double	S35-2194	456.51	S35-2896	487.07
	35	Double	S35-2195	506.86	S35-2897	540.69
	40	Double	S35-2196	629.08	S35-2898	648.23
	45	Double	S35-2197	685.72	S35-2899	714.83

## TIGER SHARK

Shredding The Competition



The first drastically new section tooth design in decades!

- Serrated Teeth Allows More Cutting Surface.
- Stays Sharper Longer
- Lasts Longer
- Cuts Faster
- Cuts Equally Well In Soybeans, Alfalfa, Grass Hay, Wheat, Etc.

**MADE IN THE USA!**



<b>B</b>	
Bale Counter.....	57
Baler Teeth.....	61
Bearings, Plastic Reel.....	61
Bolt-N-Clip Kit.....	57
Bolts, Section.....	57
<b>C</b>	
Clips, Hold Down.....	57
Combine Teeth.....	61
<b>D</b>	
Disc Mower Knives.....	60
<b>E</b>	
End Sections.....	57
<b>G</b>	
Grass Board.....	57
Guards.....	60
<b>H</b>	
Hammer Rivet Tool.....	61
Hold Down Clips.....	57
<b>K</b>	
Kits, Bolt-N-Clip.....	57
<b>P</b>	
Pitman Woods.....	57
Plastic Reel Bearings.....	61
<b>R</b>	
Rake Teeth.....	61
Reel Tines.....	61
Replacement Parts, Poly.....	61
Rivets, Section.....	57
<b>S</b>	
Sections.....	56
Section Bolts.....	57
Section Rivets.....	57
Sickle Assemblies.....	58
Sickle Heads.....	57
<b>T</b>	
Teeth, Baler.....	61
Teeth, Combine.....	61
Teeth, Rake.....	61
Tines, Reel.....	61
<b>W</b>	
Wear Plate.....	57

HERSCHEL sections are made in the USA from high quality boron steel. Heat-treated for long life. Sections are extra heavy (.116") and chrome unless stated otherwise.

**All MASSEY FERUGSON COMBINE sections have 2" hole spacing.**

**All MASSEY FERUGSON HAY MACHINES sections have 2-1/8" hole spacing.**

### SECTION TYPES

7TS = Super 7® Top Serrated      TT = Tiger Tooth  
 SM = Smooth                              TJ = Tiger Jaw  
 US = Under Serrated - 14 Tooth      SRK = Tiger Shark™  
 TS = Top Serrated - 14 Tooth



### SECTIONS

Fits MASSEY Mowers 30, 31, 32, 51, 52, 71, 135, 238. MASSEY HARRIS 5, 6, 40, 41, 60. Section is 3" x 3-1/4". Uses 5/8 OH rivet. Sold 10 sections per pack.

OEM Number	Application	Order No.	List
L 1262	XHUS	S20-5236	12.74
130356M1	XHUS	S20-5743	14.36
669807M1	XHUSCR	S20-6710	18.66



### SECTIONS

Fits MASSEY Windrowers 35, 655, 675, 755, 875. Section is 3" x 3-1/4". Uses 5/8 OH rivet. Sold 10 sections per pack.

OEM Number	Application	Design	Order No.	List
1041472M1	XHUSCR - .083	C-	S20-5236	12.74
1046779M1	XHTSCR	C	S20-4969	17.11



### SECTION - XHTS

Fits MASSEY Windrowers. Section is 3" x 3-1/4". Uses 5/8 OH rivet. Sold 10 sections per pack.

OEM Number	Order No.	List
1071707M1	S20-3283	12.91



### SECTIONS

Fits MASSEY Mower conditioners, Haytender 81, 725 & 925 (Badger). 200, 210 Swathers, 7200, 8200 Grain Tables. Section is 3" x 3-1/4". Uses 5/8 OH rivet. Sold 10 sections per pack.

OEM Number	Application	Design	Order No.	List
1036362M1	XHUS	B	S20-5107	10.58
1038969M1	XHSM	B	S20-1145	12.58
683936M1	XHTSCR	B	S20-4277	15.39
683937M1	XHUSCR	B	S20-6339	13.30
683938M1	XHSMCR	B	S20-2758	20.44
3725570M1	Tiger Shark™		S20-8396	17.20



### SECTION - XHTSCR

Fits MASSEY Windrowers 34, 36, 44. Section is 3" x 3-1/4". Uses TJBN bolt. Sold 10 sections per pack.

OEM Number	Order No.	List
261431M1H	S20-4676	21.88
160254M1		
146503M1		



### SECTION - XHTSCR

Fits MASSEY Windrowers 785, 885. Section is 3" x 3-1/4". Uses 5/8 OH rivet. Sold 10 sections per pack. Extra high shoulder

OEM Number	Order No.	List
1055090M1	S20-4097	15.15



### SECTION

Fits MASSEY Combines with floating bar, wobble drive head. Section is 3" x 2-1/2". Uses 5/8 CS rivet. Sold 10 sections per pack.

OEM Number	Description	Design	Order No.	List
1053209M1	XHTSCR	H	S20-4462	18.81
SS277444	XH7TSCR	H+	S20-4322	17.46



### SECTION - XH7TSCR - G+ TYPE

Fits MASSEY Combines. Section is 3" x 3-1/4". Uses 5/8 OH rivet. Sold 10 sections per pack.

OEM Number	Order No.	List
SS261431M1H	S20-4269	20.22

### WHY TRY TIGER SHARK™ SECTIONS?

1. Serrated teeth allow more cutting surface.
2. They last longer, cut faster.
3. Cuts equally well in soybeans, alfalfa, grass hay, wheat, etc.



### Customer Testimonial:

"I cut over 1000 acres of soybeans with the same *Herschel Tiger Shark™* sections. They stayed sharper longer and lasted longer than any section I have used."  
 - Roger Woodruff, Warren Co. Iowa

### TIGER JAW SECTIONS

Fits all MASSEY Combines with Tiger Jaw systems. Section is 3" x 2-1/4". Uses TJ55BN bolt. Sold 10 sections per pack.

Replaces Number	Description	Section Design	Order No.	List
TJ6000	XHTJCR	S	S20-4638	26.71
SSTJ6000	XHTJCR	S+	S20-4316	17.62



### TIGER SHARK

### SECTION - TIGER SHARK™

Fits MASSEY Swathers 200, 210. Section is 3" x 3-1/4". Sold 10 sections per pack.

OEM Number	Order No.	List
3725570M1	S20-8396	17.20

**UNIVERSAL END SECTIONS**

HERSCHEL "End Sections" are made of one-piece high carbon, heat-treated steel for rugged use. They are punched with an oblong hole to virtually fit any standard cutterbar mower in use today. To install our "End Section", simply take off the last section on the shoe end of your sickle assembly and replace it with an "End Section". The change-over takes only a couple of minutes to complete and you will notice a big difference in time saved from unclogging your mower. We recommend using a R36-0523D oval head rivets or B55-0065D Bolts.



Description	Order No	List	Description	Order No	List
XH7TSCR (RH) 10/Box	S20-4403	38.49	Tiger Shark™ (LH) 2/SP	S20-8445D	12.06
XH7TSCR (RH) 2/SP	S20-4403D	10.54	XHTS CR (RH) 10/Box	S20-4210	38.49
Tiger Shark™ (RH) 10/Box	S20-8403	45.13	XHTS CR (RH) 2/SP	S20-4210D	10.54
Tiger Shark™ (RH) 2/SP	S20-8403D	12.06	XHTSCR (LH) 10/Box	S20-4211	38.49
XH7TSCR (LH) 10/Box	S20-4445	41.22	XHTSCR (LH) 2/SP	S20-4211D	10.54
XH7TSCR (LH) 2/SP	S20-4445D	13.94	XHUSCR (RH) 10/Box	S20-6640	40.77
Tiger Shark™ (LH) 10/Box	S20-8445	45.13	XHUSCR (RH) 2/SP	S20-6640D	10.54

S20-8445



**BOLT-N-CLIP KIT**

For Most Sickles up to 10'. Converts most sickle bars to bolt-on sections.

Kit includes: Hold Down Clips, Section Bolts & Lock Nuts.

Order No.	List
B55-0629	40.16

**GRASS BOARD**

Fits all mowers.



Order No	List
B52-0615	44.40

**BALE COUNTER**

Bale counter, reads up to 99,999. 4-hole mounting plate, push button reset, adjustable side arm. Fits most balers.



Order No	List
T55-0002	25.30

**SECTION BOLTS**

Description	Application	Qty. Pkg.	Qty. Mstr Ctn.	Order No.	List
Section Bolt	Replaces 9/16" & 5/8" OH Rivets	50	300	B55-0065D	9.55
Head Bolt	Replaces 1" & 1 1/16" OH Rivets	15	90	B55-0085D	5.85
Head Bolt	Replaces 1-1/4" OH Rivets	12	72	B55-0095D	6.02
Section Bolt	Bolts for 10' Sickle w/head bolts (80 - B55-0065D, 5 - B55-0085D, 5 - B55-0095D)	90	Each	B55-0500D	22.76
Nut	Fits All Above Bolts	20	120	N83-0289D	5.36



**RIVETS**

Size / No. in Pkg.	Description	Application	Qty. Pkg.	Qty. Ctn.	Order No.	List
5/8" # 5-1/2 (56)	OH Rivets Asst.	7" Heavy Mower Sections and Knife Heads	Asst.	6	R36-0523D	7.75
1" # 5-1/2 (10)	Zinc Pltd.					
5/8" # 5-1/2 (72)	OH Rivets Asst.	Mower Conditioners	Asst.	6	R36-0524D	9.39
1" # 5-1/2 (5)	Zinc Pltd.					
1-1/4" OH	OH Rivets Zinc Plt.	Head Rivet	1/2#	3	R36-0467D	6.83
5/8" OH	OH Rivets Zinc Plt.	Heavy Gauge Sections	1#	6	R36-0462D	13.40
15/16" OH	OH Rivets Zinc Plt.	Head Rivet	1/2#	3	R36-0522D	6.32
1-1/4" CS	CS Rivets Zinc Plt.	Guard Plate Rivet	1/2#	3	R36-0468D	6.63
5/8" CS	CS Rivets Zinc Plt.	Section Rivet	1#	6	R36-0463D	10.94



**WEAR PLATE - 6"**

For all mowers and combines.

Replaces Number	Order No.	List
206196M1	P44-0472	3.73



**PITMAN WOOD - UNIVERSAL**

Order No.	List
P38-0560	24.25

**NEEDLE BEARING & SEAL**

Fits MASSEY Windrowers 885. Use with H15-0132 and H15-0133.

Order No.	List
B15-0681B	30.56



**SICKLE HEAD**

Fits MASSEY Windrowers 885 Auger Header. Single and double drive. Left hand. Replaces 34388.

Order No.	List
H15-0132	67.06

**HEAD BUSHING**

Fits MASSEY Windrowers 655, 755, 785.

Order No.	List
B82-0437B	21.89



**SICKLE HEAD**

Fits MASSEY Windrowers. Right hand. Replaces 34895.

Order No.	List
H15-0133	81.07

**HOLD DOWN CLIPS ADJUSTABLE**

Fits MASSEY Mowers, Windrowers, & Swathers. Cast.

Style	Order No.	List
Low Arch	C45-0006	21.39
High Arch	C45-0007	21.39



Fits MASSEY Combines, Mowers & Windrowers, except Versatile, Hart-Carter & Love. Steel.

Style	Order No.	List
Low Arch	C45-0040	5.65



**1-YEAR WARRANTY ON ALL ITEMS!**

**SICKLES**

**MOWERS DYNA-BALANCE 30, 31, 51 S/N 226040755-EARLIER, 71, 135 FEO SERIES (CAST GEAR BOX)**

OEM #	Length	No. Of		Head OEM #	Type	Section		Riveted Order No	Riveted List	Bolted Order No	Bolted List
		Sections	Head			Section	OEM #				
669791M93	7'	28	Headless	-	XHUSCR	S20-6710	669807M1	S35-3695	225.78	-	-

**MOWERS DYNA-BALANCE 41, 51 S/N 238040755-LATER, 135 (WELDED GEAR BOX)**

OEM #	Length	No. Of		Head OEM #	Type	Section		Riveted Order No	Riveted List	Bolted Order No	Bolted List
		Sections	Head			Section	OEM #				
581177M92	7'	28	H15-0975	581387M1	XHUSCR	S20-6710	669807M1	S35-3887	184.49	-	-

**MOWER CONDITIONERS 725, 925, BADGER NORTHLAND BN1000, BN1005**

OEM #	Length	No. Of		Head OEM #	Type	Section		Riveted Order No	Riveted List	Bolted Order No	Bolted List
		Sections	Head			Section	OEM #				
683583M91	9'	39	Headless	-	XHUSCR	S20-6339	683937M1	S35-3010	171.33	-	-

**MOWER CONDITIONER 81 HAYTENDER**

OEM #	Length	No. Of		Head OEM #	Type	Section		Riveted Order No	Riveted List	Bolted Order No	Bolted List
		Sections	Head			Section	OEM #				
1038699M91	9'	35	Headless	-	XHUS	S20-5107	1036362M1	S35-3620	140.02	-	-

**WINDROWER 35 PULL-TYPE**

OEM #	Length	No. Of		Head OEM #	Type	Section		Riveted Order No	Riveted List	Bolted Order No	Bolted List
		Sections	Head			Section	OEM #				
1041471M91	21'	84	Headless	-	XHTSCR	S20-4968	1046776M1	S35-4741	349.22	-	-
1050779M91	25'	100	Headless	-	XHTSCR	S20-4969	1046779M1	S35-4928	448.30	-	-

**WINDROWER W/DRAPER HEAD 655, 675, 775, 785, NH 1090, WF 6200**

OEM #	Length	No. Of		Head OEM #	Type	Section		Riveted Order No	Riveted List	Bolted Order No	Bolted List
		Sections	Head			Section	OEM #				
1046769M91H	15'	59	H15-0870	1043844M91	XHTSCR		1046776M1	S35-4737	374.21	-	-

**WINDROWERS 775, 785, 885 USING DRAPER HEADER MAC DON 7000**

OEM #	Length	No. Of		Head OEM #	Type	Section		Riveted Order No	Riveted List	Bolted Order No	Bolted List
		Sections	Head			Section	OEM #				
SS1057967M91	18'	71	Headless	-	XH7TSCR	S20-4398	SS1055090M1	-	-	S35-2262	354.08
SS1057508M91	21'	83	Headless	-	XH7TSCR	S20-4398	SS1055090M1	-	-	S35-2253	351.47
	4*	16	Headless	-	XH7TSCR	S20-4398	SS1055090M1	-	-	S35-2254	182.37
	9*	36	Headless	-	XH7TSCR	S20-4398	SS1055090M1	-	-	S35-2255	263.55

SICKLES

WINDROWERS 885 USING AUGER HEADER SINGLE DRIVE MAC DON 7000

OEM #	Length	No. Of		Head	Head OEM #	Type	Section		Riveted	Riveted	Bolted	Bolted
		Sections	Head				Section	OEM #	Order No	List	Order No	List
SS1057934M91	12'	49		Headless	-	XH7TSCR	S20-4398	SS1071707M1	-		S35-2258	258.85
1056866M91	14'	57		Headless	-	XHTSCR	S20-4170	1071707M1	-		S35-2028	264.95
SS1056866M91	14'	57		Headless	-	XH7TSCR	S20-4398	SS1071707M1	-		S35-2259	302.07
SS1057538M91	16'	65		Headless	-	XH7TSCR	S20-4398	SS1071707M1	-		S35-2260	256.73

WINDROWERS 885 USING AUGER HEADER DOUBLE DRIVE MAC DON 7000 & 9000

OEM #	Length	No. Of		Head	Head OEM #	Type	Section		Riveted	Riveted	Bolted	Bolted
		Sections	Head				Section	OEM #	Order No	List	Order No	List
	7' RH	29		Headless	-	XHTSCR	S20-4170	1071707M1	-		S35-2032	187.81
	7' LH	29		Headless	-	XH7TSCR	S20-4398	SS1071707M1	-		S35-2240	119.33
	7' RH	29		Headless	-	XH7TSCR	S20-4398	SS1071707M1	-		S35-2241	118.45
	8' LH	33		Headless	-	XHTSCR	S20-4170	1071707M1	-		S35-2033	224.03
	8' RH	33		Headless	-	XHTSCR	S20-4170	1071707M1	-		S35-2034	224.03
	8' LH	33		Headless	-	XH7TSCR	S20-4398	SS1071707M1	-		S35-2242	147.18
	8' RH	33		Headless	-	XH7TSCR	S20-4398	SS1071707M1	-		S35-2243	130.24

MOWER CONDITIONERS 34, 36, 44

OEM #	Length	No. Of		Head	Head OEM #	Type	Section		Riveted	Riveted	Bolted	Bolted
		Sections	Head				Section	OEM #	Order No	List	Order No	List
146471M91	16'	63		H15-0205	144306M91	XHTSCR	S20-4676	146503M2, 160254M1, 261431M1	S35-4375	373.39	-	-
146253M91	18'	71		H15-0205	144306M91	XHTSCR	S20-4676	146503M2, 160254M1, 261431M1	S35-4205	408.37	-	-

WINDROWERS 613, 625

OEM #	Length	No. Of		Head	Head OEM #	Type	Section		Riveted	Riveted	Bolted	Bolted
		Sections	Head				Section	OEM #	Order No	List	Order No	List
SS1069665M91	21'	83		Headless	-	XH7TSCR	S20-4398	SS34390CR	-		S35-2253	351.47
SS1065051M91	4*	16		Headless	-	XH7TSCR	S20-4398	SS34390CR	-		S35-2254	182.37
SS1065052M91	9*	36		Headless	-	XH7TSCR	S20-4398	SS34390CR	-		S35-2255	263.55
SS1069665M91	15*	60		Headless	-	XH7TSCR	S20-4398	SS34390CR	-		S35-2256	221.11

COMBINE 540, 550, 750, 760, 850, 860 USING FLOATING BAR OR WOBBLE DRIVE, 1859 USING FLEX HEADER

OEM #	Length	No. Of		Head	Head OEM #	Type	Section		Riveted	Riveted	Bolted	Bolted
		Sections	Head				Section	OEM #	Order No	List	Order No	List
SS1053193M92	15'	61		Headless	-	XH7TSCR	S20-4332P	SS1053209M1	S35-4280	206.73	-	-
SS1053196M92	20'	81		Headless	-	XH7TSCR	S20-4332P	SS1053209M1	S35-4282	285.65	-	-

COMBINE 410, 510, 540, 550, 750, 850, 760 & 860 W/RIGID 1859 HEAD 2381 & 9000 SERIES & HINIKER

OEM #	Length	No. Of		Head	Head OEM #	Type	Section		Riveted	Riveted	Bolted	Bolted
		Sections	Head				Section	OEM #	Order No	List	Order No	List
SS260632M94, SS282344M93	24'	95		Headless	-	XH7TSCR	S20-4269	SS146503M3	-		S35-2062	561.07

## HERSCHEL DISC MOWER KNIVES - MADE IN THE USA

- Manufactured in the U.S.A. to meet ISO 5718 standard on Knives for agricultural rotary disc mowers.
- Manufactured from high quality U.S.A. 10B38 (boron) steel.
- Edges are formed not ground to prevent edges from chipping & breakage.
- Entire knife is belt, not batch heat treated to a RC hardness of 45-52. Batch heat treating can cause knives on the inside of the batch to vary greatly in hardness compared to knives on the outside of the batch.
- Each knife is stamped with our name, date and lot number to allow us to trace the manufacturing process on each knife. This allows traceability of the steel back to the steel mill and the mills heat lot of the steel used in the knife.

### DISC MOWER KNIVES

Fits MASSEY 164, 166, 530

Length: 3.66"	Degree of Twist: 13	Hole Diameter: .64
Width: 1.60	Thickness: 0.116	Center Of Hole To Back Edge: .80

OEM Number	Style	Shape	Bolt Order No	6 Blades Order No	List	25 Blades Order No	List
CC19336	4	LH Twisted	B55-0358D	B45-6996D	10.18	B45-6996	30.57
CC19333	4	RH Twisted	B55-0358D	B45-6997D	10.18	B45-6997	35.62



### DISC MOWER KNIVES

Fits MASSEY 1306, 1307, 1308, 1309, 1310, 1326, 1327, 1328, 1329, 1330, 1339, 1359

Length: 4.76"	Degree of Twist: 13	Hole Diameter: .89
Width: 1.88	Thickness: 0.165	Center Of Hole To Back Edge: .78

OEM Number	Style	Shape	Bolt Order No	6 Blades Order No	List	25 Blades Order No	List
113385A1	5	RH Twisted	B55-0355D	B45-6563D	10.51	B45-6563	41.18
113384A1	5	LH Twisted	B55-0355D	B45-6564D	10.51	B45-6564	41.18



### DISC MOWER KNIVES

Fits MASSEY 1345, 1355, 1365, 1372, 1375, 9070, 9075, 9080, 9175, 9185

Length: 4.21"	Degree of Twist: 13	Hole Diameter: .72
Width: 1.78	Thickness: 0.169	Center Of Hole To Back Edge: .80

OEM Number	Style	Shape	Bolt Order No	6 Blades Order No	List	25 Blades Order No	List
700712888	4	RH Twisted	B55-0344D	B45-6568D	9.83	B45-6568	39.24
700712889	4	LH Twisted	B55-0344D	B45-6569D	9.83	B45-6569	39.24

Length: 4.21"	Degree of Twist: 13	Hole Diameter: .73
Width: 1.86	Thickness: 0.175	Center Of Hole To Back Edge: .78

OEM Number	Style	Shape	Bolt Order No	6 Blades Order No	List	25 Blades Order No	List
700711857	5	RH Twisted	B55-0342D	B45-6559D	9.39	B45-6559	37.96
700711858	5	LH Twisted	B55-0342D	B45-6560D	9.39	B45-6560	37.96



### FORGED STEEL GUARD

Fits MASSEY Mowers 30, 31, 51, 71. Replaces 67937M91. Center guard, dyna balance.

Order No	List
G81-0181	12.80



### FORGED STEEL GUARD

Fits MASSEY Mower Conditioners, MF 81 Haytender. Replaces 1036339M1, FS72-2, BU280.

Order No	List
G81-0065	18.93



### FORGED STEEL GUARD

Fits MASSEY Windrowers 655, 35, 675, 775, 785. Replaces 1041468M1, FS73-2, BU235.

Order No	List
G81-0070	13.96



### FORGED STEEL GUARD

Fits MASSEY 725, 925, MF 885 Windrowers. Replaces 683476M9/994M1, FS81-DH, BU215H.

Order No	List
G81-0155	9.37
G81-0098 - Double Heat Treat	11.23
G81-0231 - Boron	11.23

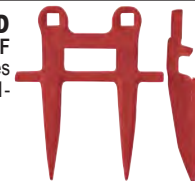

### FORGED STEEL GUARD

Fits MASSEY Combines 540, 550, 750, 760, 1859 Flex (HC). Replaces FC89-2, HA231.

Order No	List
G81-0125	16.78



### FORGED STEEL GUARD

Fits MASSEY Rigid combines. Replaces 228392M2, FC62-2A, HA240A.

Order No	List
G81-0191	8.79



## Our Agricultural Background - Cutting Parts

Founded in 1887, by two brothers, Paul E and H. Robert Herschel. R. Herschel Manufacturing quickly became a leader in the sickle section industry.

For more than 130 years HERSCHEL has been an innovator in the cutting parts industry and introduced the chrome plated section (1950), Tiger Jaw® (1981) and Tiger Jaw 2000® (1997) combine conversion kits, Super 7® sections (1992) and most recently the Tiger Shark™ section (2016). Cutting parts designed to provide the agricultural industry with a high quality product at an exceptional value. We are proud to still make our popular cutting products at our factory in Indianola, IA.

### CONICAL GUARD BOLT NUT

Package includes 5 7/16" nuts.

Order No	List
N83-0593D	3.29



**RAKE TOOTH**

For MASSEY Rakes to 1958, model 20 to s/n 14449. Replaces 667656M1. Spring. 100 per box.

<u>Order No.</u>	<u>List</u>
T16-0367	2.44



**RAKE TOOTH**

For MASSEY Rakes including MH21, 25 s/n 14450 - , 36, 37. Replaces 667530M0, 668364M1, DE0435A. Spring. 100 per box.

<u>Order No.</u>	<u>List</u>
T16-0335	2.80

**RUBBER MOUNT  
RAKE TOOTH**

For MASSEY Rakes 640, 650, 660, 670, 671. Replaces RMT-1. Rubber mount. 100 per box.



<u>Order No.</u>	<u>List</u>
T16-0182	2.07



**BALE TOOTH**

For MASSEY Round Balers 1440, 1560. Replaces 1053394M91. Spring. 100 per box.

<u>Order No.</u>	<u>List</u>
T16-0485	3.65

**SPRING TOOTH**

For MASSEY 1440. Replaces 4000-997. 50 per box.



<u>Order No.</u>	<u>List</u>
T16-0488	5.47

• **PATENTED 2 PIECE DESIGN.**  
• **SAVE MONEY!**  
**REPLACE ONLY THE TINE.**



**HERSCHEL 6" 2-PIECE POLY TINES  
FOR PIPE REELS**

Description	Pkg. Qty.	Order No	List
Tine & Clamp	100/Box	T16-0740	198.88
Tine & Clamp	10/Box	T16-0745	21.80
Tine ONLY	100/Box	T16-0750	130.64



**2 PIECE M/L REEL TINE**

For Most Pipe Style Reels with 4" bat. Replaces 782551, 1989438C1, AH136689, AH153175. Includes clamps. 100 per box.

<u>Order No.</u>	<u>List</u>
T16-0720	175.64



**2 PIECE M/L REEL TINE**

For Most Pipe Style Reels with 4" bat. Replaces 782226, 1989438C1, AH136689, AH153175. Includes clamps. 10 per bag.

<u>Order No.</u>	<u>List</u>
T16-0715	19.03



**M/L REEL TINE**

For T16-0715 and T16-0720. No clamps. Replaces HA100MLT. Tine only, no clamps. 100 per box.

<u>Order No.</u>	<u>List</u>
T16-0725	128.83



**PLASTIC BEARING KIT**

Includes 6 caps, 6 bases, U-Bolts and 12 nuts.

Application: Reels with Wood Bats.

<u>Order No.</u>	<u>List</u>
B15-0915	27.47



**PLASTIC BEARING KIT**

Includes 12 bearing halves, 12 bolts, and 12 nuts.

Application: Reels with Tear Drop Bats and Rear Mounted Plastic Tines used on MF 9700, 9750.

<u>Order No.</u>	<u>List</u>
B15-0920	50.91



**PLASTIC BEARING KIT**

Includes 12 bearing halves, 6 bolts, and 6 nuts.

Application: Pipe Reels with Plastic Tines used on MF 9700, 9750.

<u>Order No.</u>	<u>List</u>
B15-0925	24.64

**REPLACEMENT  
SCREW**

For T16-0715 and T16-0720. No clamps. Replaces HA20SC. 20 per box.

<u>Order No.</u>	<u>List</u>
B55-0096D	2.40

**1-YEAR WARRANTY  
ON ALL ITEMS!**



**HAMMER RIVET TOOL**

For Drive Rivets

<u>Order No.</u>	<u>List</u>
T55-0812	30.72

## B

Bale Counter.....	74
Baler Teeth.....	75
Board, Grass.....	74
Bolt-N-Clip Kit.....	64
Bolts, Section.....	66

## D

Disc Mower Knives.....	73 - 74
------------------------	---------

## E

End Sections.....	64
-------------------	----

## G

Grass Board.....	74
Guards.....	72

## H

Hammer Rivet Tool.....	75
Hold Down Clips.....	73 - 74

## K

Kits, Overlap Section.....	64
----------------------------	----

## O

Overlap Sections.....	64
Overlap Section Kits.....	64

## P

Pitman Wood.....	74
------------------	----

## R

Rake Teeth.....	75
Rake Wheels.....	74
Reel Teeth.....	75
Rivets, Section.....	66

## S

Sections.....	63 - 65
Section Bolts.....	66
Section Rivets.....	66
Sickle Heads.....	70 - 71
Sickles.....	66 - 70
Sickles, Versatile.....	66
Spliced Sickles.....	70

## T

Teeth, Baler.....	75
Teeth, Rake.....	75
Teeth, Reel.....	75

## V

Versatile Sections.....	65
Versatile Sickles.....	66

## W

Wear Plates.....	74
------------------	----



HERSCHEL sections are made in the USA from high quality boron steel. Heat-treated for long life. Sections are extra heavy (.116") and chrome unless stated otherwise.

All NEW HOLLAND sections have 2-1/16" hole spacing.

## WHY TRY TIGER SHARK™ SECTIONS?

1. Serrated teeth allow more cutting surface.
2. They last longer, cut faster.
3. Cuts equally well in soybeans, alfalfa, grass hay, wheat, etc.



## SECTION TYPES

7TS = Super 7® Top Serrated      TT = Tiger Tooth  
 SM = Smooth      TJ = Tiger Jaw  
 US = Under Serrated - 14 Tooth      SRK = Tiger Shark™  
 TS = Top Serrated - 14 Tooth

## Customer Testimonial:

"I cut over 1000 acres of soybeans with the same **Herschel Tiger Shark™** sections. They stayed sharper longer and lasted longer than any section I have used."

- Roger Woodruff, Warren Co. Iowa

**SECTIONS - .116" THICK**  
 Fits NEW HOLLAND Mowers and Conditioners. Section is 3" x 3-1/4". Uses 5/8 OH rivet. Sold 10 sections per pack.

Replaces		Reference		
Number	Description	Number	Order No	List
26622	XHSM		S20-1145	12.58
29875	XHUS	B-	S20-5107	10.58
706226	XHUSCR	B-	S20-6339	13.30

**SECTIONS - .083" THICK**  
 Fits NEW HOLLAND Mowers and Conditioners. Section is 3" x 3-1/4". Uses 1/2 OH rivet. Sold 10 sections per pack.

Replaces		Reference		
Number	Description	Number	Order No	List
67631	RTS	B	S20-3412	14.88

**SECTION - XHTSCR**  
 Fits NEW HOLLAND TR Series Combine, 970, 971, 972, 973. Section is 3" x 3-1/4". Uses 5/8 OH rivet. Sold 10 sections per pack.

Replaces		
Number	Order No	List
694723	S20-4790	19.92

**SECTIONS**  
 Fits NEW HOLLAND 109 Pull-Type Windrower, 1090 Windrower. Section is 3" x 3-1/4". Uses 1/2 OH rivet. Sold 10 sections per pack.

Replaces		Reference		
Number	Description	Number	Order No	List
275522	XHTSCR	C	S20-4969	17.11

**SECTION - XHTSCR**  
 Fits NEW HOLLAND Combines with Love Floating Headers. Section is 3" x 3". Uses 5/8 CS rivet. Sold 10 sections per pack.

Replaces		
Number	Order No	List
271981 CR	S20-4608	18.01

**SECTION - XHTSCR**  
 Fits NEW HOLLAND Combines with Rigid Headers. Section is 3" x 3-1/4". Uses 5/8 OH rivet. Sold 10 sections per pack.

Replaces		
Number	Order No	List
134104	S20-4719	18.01

**SECTIONS**  
 Fits NEW HOLLAND Mowers and Conditioners, 71C, 72C, 73C, 74C Grain heads. Section is 3" x 3-1/4". Uses 5/8 OH rivet. Sold 10 sections per pack. *The Tiger Shark™ section can be used in place of the sections listed below.*

Replaces		Reference		
Number	Description	Number	Order No	List
	<b>Tiger Shark™</b>		<b>S20-8268</b>	<b>13.37</b>
9622744, 826720C3, 86615988	XHTS	B	S20-3276	10.59
9622744, 112074A1, 86616691	XH7TS	B+	S20-3325	10.54
596321R4, 86616689	XH7TSCR	B+	S20-4268	12.75
700705300, 86616527	XHTSCR	B	S20-4277	15.39

**SECTIONS**  
 Fits NEW HOLLAND NH740CH, NH880CF. Section is 3" x 3-1/4". Sold 10 sections per pack. *The Tiger Shark™ section can be used in place of the sections listed below.*

Replaces		Reference		
Number	Description	Number	Order No	List
	<b>Tiger Shark™</b>		<b>S20-8549</b>	<b>12.92</b>
8728905	B+		S20-3549	12.29



### OVERLAP SECTIONS - .083" THICK

Fits NEW HOLLAND Double drive sickles. Section is 3" x 3-1/4". Sold 10 sections per pack.

**Replaces**

Number	Description	Rivet Used	Order No	List
706423	XHUSCR	Top CS	S20-4882	20.50

S20-5127



### OVERLAP SECTIONS - XHUS - .116" THICK

Fits NEW HOLLAND Double drive sickles. Section is 3" x 3-1/4". Sold 10 sections per pack.

**Replaces**

Number	Rivet Used	Order No	List
635161	Bottom CS	S20-5126	17.80
635162	(Top C.S.)	S20-5127	18.43

S20-4371

S20-4370



### OVERLAP SECTIONS - XHTSCR .116" THICK

Fits NEW HOLLAND Double Drive Sickles. Section is 3" x 3-1/4". Sold 10 sections per pack.

**Replaces**

Number	Rivet Used	Order No	List
635161	Bottom CS	S20-4371	23.65
635162	Top CS	S20-4370	23.53

### OVERLAP SECTION KIT - 14 TOOTH

For New Holland machines. Contains: (2) S20-4882 - 706423, RTSCR Top CTSK (3) S20-4883 - 706424 RTSCR Btm. CTSK, (10) B55-0059-CTSK Bolt & Nut

Order No	List
S20-4001	19.52

### OVERLAP SECTION KIT - SUPER 7®

Fits New Holland 1475, 2200, 2300, 2450, 2550, 12HS, 14HS, 16HS and other double drive NH windrowers using tomahawk style overlap section. Kit includes 2 of S20-4308, 4 of S20-4309, 1 wear strip, 6 5/8" CS bolts, 6 1/2" CS bolts and nuts.

Order No	List
S20-4005	19.64

S20-4308

S20-4309



### OVERLAP SECTIONS - .116" THICK

Fits NEW HOLLAND Double Drive Sickles. Section is 3" x 3-1/4". Sold 10 sections per pack.

**Replaces**

Number	Type	Rivet Used	Order No	List
SS635162	XH7TSCR	Top CS	S20-4308	19.66
SS635162	TIGER SHARK™	Top CS	S20-8308	17.96
SS635161	XH7TSCR	Bottom CS	S20-4309	17.32
SS635161	TIGER SHARK™	Bottom CS	S20-8309	17.96

### OVERLAP SECTION KITS - SUPER 7®

Fits New Holland 1475, 2200, 2300, 2450, 2550, 12HS, 14HS, 16HS and other double drive NH windrowers using tomahawk style overlap section.

Contains 3 bottom countersunk sections, 2, 3" Top countersunk sections, 1 Tomahawk style section, bolts and nuts.

Order No	List
S20-4008	24.54

### UNIVERSAL END SECTIONS

HERSCHEL "End Sections" are made of one-piece high carbon, heat-treated steel for rugged use. They are punched with an oblong hole to virtually fit any standard cutterbar mower in use today. To install our "End Section", simply take off the last section on the shoe end of your sickle assembly and replace it with an "End Section". The change-over takes only a couple of minutes to complete and you will notice a big difference in time saved from unclogging your mower. We recommend using a R36-0523D oval head rivets or B55-0065D Bolts.

S20-4210

S20-6640

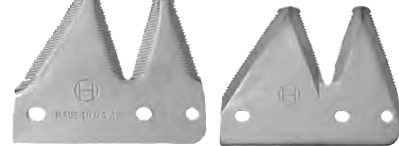

S20-8445

Description	Order No	List	Description	Order No	List
XH7TSCR (RH) 10/Box	S20-4403	38.49	Tiger Shark™ (LH) 2/SP	S20-8445D	12.06
XH7TSCR (RH) 2/SP	S20-4403D	10.54	XHTS CR (RH) 10/Box	S20-4210	38.49
Tiger Shark™ (RH) 10/Box	S20-8403	45.13	XHTS CR (RH) 2/SP	S20-4210D	10.54
Tiger Shark™ (RH) 2/SP	S20-8403D	12.06	XHTSCR (LH) 10/Box	S20-4211	38.49
XH7TSCR (LH) 10/Box	S20-4445	41.22	XHTSCR (LH) 2/SP	S20-4211D	10.54
XH7TSCR (LH) 2/SP	S20-4445D	13.94	XHUSCR (RH) 10/Box	S20-6640	40.77
Tiger Shark™ (LH) 10/Box	S20-8445	45.13	XHUSCR (RH) 2/SP	S20-6640D	10.54



### Our Agricultural Background - Cutting Parts

Founded in 1887, by two brothers, Paul E and H. Robert Herschel. R. Herschel Manufacturing quickly became a leader in the sickle section industry.

For more than 130 years HERSCHEL has been an innovator in the cutting parts industry and introduced the chrome plated section (1950), Tiger Jaw® (1981) and Tiger Jaw 2000® (1997) combine conversion kits, Super 7® sections (1992) and most recently the Tiger Shark™ section (2016). Cutting parts designed to provide the agricultural industry with a high quality product at an exceptional value. We are proud to still make our popular cutting products at our factory in Indianola, IA.

### BOLT-N-CLIP KIT

Bolts are Better Than Rivets

- Bolts will not turn in Knife Back and are reusable.
- They will last thru the life of several sections.
- Bolts may be replaced easily if accidentally damaged or broken.
- No special tools are needed to change sections, only a 7/16" wrench or socket.
- Bolts and nuts hold better than rivets and they have a greater "clamp load" than rivets.



Fits NEW HOLLAND Mowers, Mower Conditioners and Combines up to 10'. Includes special high clearance hold down clips, over the head clip, section bolts and lock nuts.

Order No.	List
B55-0629	40.16

HERSCHEL sections are made in the USA from high quality boron steel. Heat-treated for long life. Sections are extra heavy (.116") and chrome unless stated otherwise.

All NEW HOLLAND sections have 2-1/16" hole spacing.

### SECTION TYPES

- 7TS = Super 7® Top Serrated
- SM = Smooth
- US = Under Serrated - 14 Tooth
- TS = Top Serrated - 14 Tooth
- TT = Tiger Tooth
- TJ = Tiger Jaw
- SRK = Tiger Shark™

### WHY TRY TIGER SHARK™ SECTIONS?

1. Serrated teeth allow more cutting surface.
2. They last longer, cut faster.
3. Cuts equally well in soybeans, alfalfa, grass hay, wheat, etc.



### Customer Testimonial:

"I cut over 1000 acres of soybeans with the same **Herschel Tiger Shark™** sections. They stayed sharper longer and lasted longer than any section I have used." - Roger Woodruff, Warren Co. Iowa

S20-4639

S20-4317

**TIGER JAW SECTIONS**  
Fits NEW HOLLAND Combines with Tiger Jaw systems. Section is 3" x 3-1/4". Uses TJ55BN bolt. Sold 10 sections per pack. Top countersunk.

Replaces		Reference		
Number	Description	Number	Order No	List
TJ7000	XHTTCR	R	S20-4639	17.63
TJ7000	XH7TTCR	R+	S20-4317	17.62

S20-8398

S20-4398

S20-3283

**SECTIONS**  
Fits NEW HOLLAND 82C, 83C, 84C, 86C Headers. Section is 3" x 3-1/4". Uses TJ55BN bolt. Sold 10 sections per pack. *The Tiger Shark™ section can be used in place of the sections listed below.*

Replaces		Reference		
Number	Description	Number	Order No	List
	Tiger Shark™		S20-8398	14.81
87422066CR	XH7TSCR	C+	S20-4398	14.10
1327448C1	XHTS	C	S20-3283	12.91
137448C1CR	XH7TTCR		S20-4170	16.91

## FORD SECTIONS

S20-3407

**SECTION - XH7TS**  
Fits FORD Mowers, Windrowers and Swathers. Section is 3" x 3-1/4". Sold 10 sections per pack.

Order No	List
S20-3407	11.15

S20-2758

**SECTION - XHSMCR**  
Fits FORD Mowers and Mower Conditioners. Section is 3" x 3-1/4". Sold 10 sections per pack.

Replaces		Reference
Number	Order No	List
141197CR	S20-2758	20.44

S20-5246

S20-6344

S20-1142

**SECTIONS**  
Fits FORD Mowers. Section is 3" x 3-1/4". Sold 10 sections per pack.

Replaces		Reference		
Number	Description	Number	Order No	List
141198, 141113	XHUS	A-	S20-5246	11.24
141198 CR	XHUSCR	A-	S20-6344	20.22
141197	XHSM		S20-1142	13.22

## VERSATILE SECTIONS

S20-3975

**SECTIONS - .116" THICK**  
Fits VERSATILE Windrowers 10, 103, 400, 4400. Section is 3" x 3". Uses B55-0065D bolt. Sold 10 sections per pack.

Replaces		Reference		
Number	Description	Number	Order No	List
VS 1616 BN	XHTS for Bolts (w/Low Shoulder)	D	S20-3975	19.64
SSVS1616BN	XH7TS (w/Low Shoulder)	D+	S20-3425	15.81

S20-4450

S20-3287

S20-3288

**SECTIONS -.083" THICK**  
Fits VERSATILE Windrowers 10, 103, 400, 4400. Section is 3" x 3". Uses 1/2 CS rivet. Sold 10 sections per pack.

Replaces		Reference		
Number	Description	Number	Order No	List
SW 1616 CR	RTSCR (w/Low Shoulder)	D	S20-4448	17.83
SW 1776 CR	RTSCR (w/Hi Shoulder)	E	S20-4450	16.60
SSW1776	R7TS (w/Hi Shoulder)	E+	S20-3287	18.93
SSW1616	R7TS (w/Low Shoulder)	D+	S20-3288	14.52

## SECTION BOLTS

- Quick and easy section changes are possible with bolts.
- No more cutting, chiseling, or grinding - simply unbolt the section, replace and tighten bolts.
- Bolts will not turn in Knife Back and are reusable. They will last thru the life of several sections.
- Bolts may be replaced easily if accidentally damaged or broken.
- No special tools are needed to change sections, only a 7/16" wrench or socket.
- Bolt and nuts hold better than rivets and they have a greater "clamp load" than rivets.
- Special lock nuts will not vibrate loose.

Description	Qty. Application	Qty. Pkg.	Mstr.	Order No.	List
Section Bolt w/nut	Universal - Replaces 9/16" & 5/8" OH Rivets	50	300	B55-0065D	9.55
Head Bolt w/nut	Universal - Replaces 1-1/2" & 1-1/16" OH Rivets	15	90	B55-0085D	5.85
Head Bolt w/nut	Universal - 1-1/2" OH Rivets	12	72	B55-0095D	6.02
Section Bolt w/nut	Universal - Bolts for 10' Sickle w/head Bolts Include (80) B55-0065, (5) B55-0085, (5) B55-0095	90	Each	B55-0500D	22.76
Nut	Universal - Used On All Above Bolts	20	120	N83-0289D	5.36
Conical Guard Bolt Nut	For 7/16" Bolt	5	30	N83-0593D	3.29
Low Profile Nut	Double Drive Sickles for Overlap Bolts	20	120	N83-0295D	5.45
5/8" Bolt & Nut, Oval Shoulder, For Sections	Versatile - Windrower 4400, 2400, 2800	20	120	B55-0955D	8.03
7/8" Bolt & Nut, Oval Shoulder, For Heads	Versatile - Windrower 4400, 2400, 2800	10	60	B55-0975D	3.84
Overlap Bolt w/low profile nut 1/2" CS	Double Drive Sickles (use with Allen Wrench)	10	60	B55-0059D	7.06
9/16" CS Section Bolt & Nut	Countersunk Bolt. 60°	20	120	B55-0056D	10.82
5/8" Section Bolt & Nut	Countersunk Bolt. 60°	20	120	B55-0057D	5.05
1" CS Head Bolt & Nut	Versatile - Head Bolt	10	60	B55-0058D	8.56
1" CS Ribbed Bolt & Nut	Versatile Bolted Sickles	25	150	B55-0971D	10.34



## RIVETS

Size/No. in Pkg.	Description	Application	Qty. Pkg.	Mstr. Ctn.	Order No.	List
5/8" # 5-1/2 (56)	OH Rivets Asst.	7' Heavy Mower Sections	Asst.	6	R36-0523D	7.75
1" # 5-1/2 (10)	Zinc Pltd.	and Knife Heads				
5/8" # 5-1/2 (72)	OH Rivets Asst.	Mower Conditioners	Asst.	6	R36-0524D	9.39
1" # 5-1/2 (5)	Zinc Pltd.					
1-1/4" # 5-1/2 (5)						
5/8" OH #5-1/2	OH Rivets Zinc Plt.	Heavy Gauge Sections	1#	6#	R36-0462D	13.40
15/16" OH #5-1/2	OH Rivets Zinc Plt.	Head Rivet	1/2#	3#	R36-0522D	6.32
1-1/4" OH #5-1/2	OH Rivets Zinc Plt.	Head Rivet	1/2#	3#	R36-0467D	6.83
5/8" CS #5-1/2	CS Rivets Zinc Plt.	Section Rivet	1#	6#	R36-0463D	10.94
1-1/4" CS #5-1/2	CS Rivets Zinc Plt.	Guard Plate Rivet	1/2#	3#	R36-0468D	6.63



## VERSATILE SICKLE ASSEMBLIES RIVETED AND BOLTED

S35-4551



LS = Low Shoulder  
HS = High Shoulder

OEM #	Section Type	No. Of Sections	Size	Application	Section Number	Description	Head Number	Riveted Order No	Riveted List	Bolted Order No	Bolted List
SWA1622CR	R TS CR	(48)	12'	Windrowers	SW 1616 CR	LS	SWA 28253	S35-4551	240.12	-	-
SWA1783CR	R TS CR	(48)	12'	10, 103, 400	SW 1776 CR	HS	SWA 28253	S35-4869	264.95	-	-
SWA1786CR	R TS CR	(60)	15'	10 Pull Type	SW 1776 CR	HS	SWA 28253	S35-4176	279.67	-	-
SWA25571CR	R TS CR	(60)	15'		SW 1616 CR	LS	SWA 28253	S35-4985	227.83	-	-
SWA1789	R TS	(72)	18'		SW 1776	HS	SWA 28253	S35-3890	261.40	-	-
SWA1789CR	R TS CR	(72)	18'		SW 1776 CR	HS	SWA 28253	S35-4275	320.56	-	-
SWA25572CR	R TS CR	(72)	18'		SW 1616 CR	LS	SWA 28253	S35-4988	247.22	-	-
SWA3311	R TS	(80)	20'		SW 1776	HS	SWA 28253	S35-3273	290.70	-	-
SWA3311CR	R TS CR	(80)	20'		SW 1776 CR	HS	SWA 28253	S35-4274	377.42	-	-
SWA25573CR	R TS CR	(80)	20'		SW 1616 CR	LS	SWA 28253	S35-4991	308.98	-	-
SSVS4-SB	H7TS	(16)	4' Ext.	Windrowers* 10, 103, 400. Pull Tvøe 10, 4400	SSVS1616BN	LS	Less Head	-	-	S35-1088	109.00
SSVS15-SB	H7TS	(60)	15'		SSVS1616BN	LS	Less Head	-	-	S35-1084	259.71
SSVS18-SB	H7TS	(72)	18'		SSVS1616BN	LS	Less Head	-	-	S35-1085	349.16
SSVS20-SB	H7TS	(80)	20'		SSVS1616BN	LS	Less Head	-	-	S35-1086	397.26
SSVS22-SB	H7TS	(88)	22'		SSVS1616BN	LS	Less Head	-	-	S35-1087	448.35
*Note: Bolted sickles use B55-0955D 5/8" Oval CTSK Shoulder Bolts.											
6832174	H TS CR	(28)	7' LH	4814 Auqer Header	700705300		6821078 LH	S35-4390	275.74	-	-
6832224	H TS CR	(29)	7' RH		700705300		6821136 RH	S35-4391	275.74	-	-
SSBN6832174	XH7TS CR	(28)	7' LH		SS700705300		6821078 LH	-	-	S35-2285	224.04
SS6832224	XH7TSCR	(28)	7' RH		SS700705300		6821136 RH	-	-	S35-2286	223.91

**SICKLES**

**FORD MOWERS 515 SERIES**

OEM #	Length	No. Of Sections	Head	Head OEM #	Type	Section	Section OEM #	Riveted Order No	Riveted List	Bolted Order No	Bolted List
241905	7'	(29)		242063	XHUS		141198	S35-3367	190.10	-	

**FORD MOWERS 175, 176, 257, 258, 259, 260, 501 SERIES, 14-94, 95, 96, 97**

OEM #	Length	No. Of Sections	Head	Head OEM #	Type	Section	Section OEM #	Riveted Order No	Riveted List	Bolted Order No	Bolted List
240890	7'	(28)		147874	XHSM		141197	S35-3658	198.72	-	
240891	7'	(28)		147874	XHUS		141198	S35-3659	141.42	-	

**FORD MOWERS 505 SERIES AND 538**

OEM #	Length	No. Of Sections	Head	Head OEM #	Type	Section	Section OEM #	Riveted Order No	Riveted List	Bolted Order No	Bolted List
462381R9	7'	(28)		56692C91	XHSM		26622	S35-3668	151.23	-	
462380R9	7'	(28)		56692C91	XHUS		29875	S35-3667	110.63	-	
463182R9	9'	(36)		56692C91	XHSM		26622	S35-3672	136.64	-	
463159R9	9'	(36)		56692C91	XHUS		29875	S35-3669	115.53	-	

**FORD MOWERS 535**

OEM #	Length	No. Of Sections	Head	Head OEM #	Type	Section	Section OEM #	Riveted Order No	Riveted List	Bolted Order No	Bolted List
290627S	9'	(35)	Less Head	-	XHUS		OU577HS	S35-3620	140.02	-	

**FORD MOWER/CONDITIONER 538**

OEM #	Length	No. Of Sections	Head	Head OEM #	Type	Section	Section OEM #	Riveted Order No	Riveted List	Bolted Order No	Bolted List
101988C91	9'	(37)		824594C91	XHUS		29875	S35-3292	195.16	-	

**NEW HOLLAND MOWERS 44, 45, 46, 47**

OEM #	Length	No. Of Sections	Head	Head OEM #	Type	Section	Section OEM #	Riveted Order No	Riveted List	Bolted Order No	Bolted List
MA22837	7'	(28)		MA999	XHUS		826722C1	S35-3630	115.90	-	

**NEW HOLLAND MOWER 450 AFTER S/N 87764 AND 455 AFTER S/N 88846 451 WITH SINGLE GUARDS**

OEM #	Length	No. Of Sections	Head	Head OEM #	Type	Section	Section OEM #	Riveted Order No	Riveted List	Bolted Order No	Bolted List
143607	7'	(28)		858740	XHUS		29875	S35-3389	171.57	-	
143609	9'	(36)		858740	XHUS		29875	S35-3390	173.62	-	
143609	9'	(36)		858740	XHTS		29875	S35-3342	235.68	-	

**NEW HOLLAND MOWERS 451 AND 456 WITH DOUBLE GUARDS**

OEM #	Length	No. Of Sections	Head	Head OEM #	Type	Section	Section OEM #	Riveted Order No	Riveted List	Bolted Order No	Bolted List
SS228435,	7'	(29)		858740	XH7TS		SS9622744	-		S35-1024	247.90
SS858744	7'	(29)		858740	XH7TSCR		SS604921H	-		S35-2289	174.69
TT228435	7'	(29)		TT143603	XHTTCR		9622744	-		S35-2566	178.59
SSTT228435	7'	(29)		TT143603	XH7TTTCR		SSTJ7000	-		S35-2362	210.51
5228435	7'	(29)		143603	XHUS		29875	S35-3884	121.76	-	
858745	9'	(35)		858740	XHUS		29875	-		S35-2558	182.18
					Tiger Shark™					S35-1704	199.30
					Tiger Shark™					S35-2552	175.67
SS858745	9'	(35)		858740	XH7TSCR		SS29875	-		S35-2128	150.37
228434	9'	(35)		858740	XH7TS		29875	S35-3006	126.57	-	
228434	9'	(35)		143603	XHUS		29875	S35-3885	158.98	-	

**NEW HOLLAND MOWER CONDITIONER 460 AND 461**

OEM #	Length	No. Of Sections	Head	Head OEM #	Type	Section	Section OEM #	Riveted Order No	Riveted List	Bolted Order No	Bolted List
134186	9'	(35)		86507377	XHUS		29875	S35-3282	225.83	-	

**NEW HOLLAND MOWER CONDITIONER 467**

OEM #	Length	No. Of Sections	Head	Head OEM #	Type	Section	Section OEM #	Riveted Order No	Riveted List	Bolted Order No	Bolted List
137214	7'	(29)		86507377	XHUS		29875	S35-3057	192.56	-	

## SICKLES

### NEW HOLLAND MOWER CONDITIONER 469, 1469

OEM #	Length	No. Of Sections	Head	Head OEM #	Type	Section	Section OEM #	Riveted Order No	Riveted List	Bolted Order No	Bolted List
648844	9'	(37)	-	86507377	XHUS	-	29875	S35-3055	175.82	S35-1705	208.69
SS86518678	9'	(37)	-	86507377	XH7TS	-	SS9622744	-	-	S35-3164	249.86

### NEW HOLLAND MOWER CONDITIONER MODEL 495 AND 1495

OEM #	Length	No. Of Sections	Head	Head OEM #	Type	Section	Section OEM #	Riveted Order No	Riveted List	Bolted Order No	Bolted List
648003	12'	(49)	-	86508155	XHUS	-	29875	S35-3128	275.33	-	-
858706	12'	(49)	-	86508155	XHUS	-	29875	-	-	S35-1708	314.85
SS9623572	12'	(49)	-	86508155	XH7TS	-	SS9622744	-	-	S35-1001	296.58

### NEW HOLLAND MODEL 472, 477, 478

OEM #	Length	No. Of Sections	Head	Head OEM #	Type	Section	Section OEM #	Riveted Order No	Riveted List	Bolted Order No	Bolted List
648832	7'	(29)	-	577868	XHUS	-	29875	S35-3864	191.29	-	-
858708	7'	(29)	-	577868	XHUS	-	29875	-	-	S35-1280	245.59

### NEW HOLLAND MOWER CONDITIONER 479, 488, 1469 AFTER S/N 220947

OEM #	Length	No. Of Sections	Head	Head OEM #	Type	Section	Section OEM #	Riveted Order No	Riveted List	Bolted Order No	Bolted List
648840	9'	(37)	-	577867	XHUS	-	29875	S35-3865	177.52	-	-
858700	9'	(37)	-	577867	XHUS	-	29875	-	-	S35-1706	234.25
SS9623570	9'	(37)	-	577867	XH7TS	-	SS9622744	-	-	S35-3165	230.61
SSTT648840	9'	(37)	-	TT577867	XH7TSCR	-	SSTJ7000	-	-	S35-2052	348.10

### NEW HOLLAND MOWER CONDITIONER 490 (S/N 259715 AND UP)

OEM #	Length	No. Of Sections	Head	Head OEM #	Type	Section	Section OEM #	Riveted Order No	Riveted List	Bolted Order No	Bolted List
579171	12'	(49)	-	86512652	XHUS	-	29875	S35-3076	323.99	-	-

### NEW HOLLAND MOWER CONDITIONER 474, 489, 492 AND 1465

OEM #	Length	No. Of Sections	Head	Head OEM #	Type	Section	Section OEM #	Riveted Order No	Riveted List	Bolted Order No	Bolted List
648831	7'	(29)	-	289488	XHUS	-	29875	S35-3375	281.86	-	-
858702	9'	(37)	-	289488CS	XHUS	-	29875	-	-	S35-1707	251.39
SS86529232	9'	(37)	-	289488CS	Tiger Shark™	S20-8268	-	-	-	S35-2561	229.97
SSTT648835	9'	(37)	-	TT289488CS	XH7TTCR	-	SSTJ7000	-	-	S35-2051	255.50
648835	X9'	(37)	-	289488	XHUS	-	29875	S35-3283	226.92	-	-

### NEW HOLLAND MOWER CONDITIONER 499, 1496, WINDROWER 1499

OEM #	Length	No. Of Sections	Head	Head OEM #	Type	Section	Section OEM #	Riveted Order No	Riveted List	Bolted Order No	Bolted List
635163	6' LH	(24)	-	86536346	XHUS	-	29875	S35-3798	287.72	-	-
9619698	6' LH	(24)	-	86536346	XHUS	-	29875	-	-	S35-1128	223.81
635279	6' RH	(25)	-	86536345	XHUS	-	29875	S35-3799	321.15	-	-
9619699	6' RH	(25)	-	86536345	XHUS	-	29875	-	-	S35-1129	223.81
SS9622712	6' LH	(24 or 25)	-	86536346	XH7TS	-	SS9622744	-	-	S35-1006	193.67
SS9622713	6' RH	(25)	-	86536345	XH7TS	-	SS9622744	-	-	S35-1007	172.49

\*Sickle comes with 25 sections. Count sections on old sickle and take 1 off at head end if need 24.

### NEW HOLLAND MODEL 109 PULL TYPE

OEM #	Length	No. Of Sections	Head	Head OEM #	Type	Section	Section OEM #	Riveted Order No	Riveted List	Bolted Order No	Bolted List
276639 CR	25'	(100)	-	Less Head	XHTSCR	-	275522	S35-4928	448.30	-	-

### NEW HOLLAND WINDROWER 1090 SELF PROPELLED

OEM #	Length	No. Of Sections	Head	Head OEM #	Type	Section	Section OEM #	Riveted Order No	Riveted List	Bolted Order No	Bolted List
275503	15'	(59)	-	275506	XHTSCR	-	275521	S35-4737	374.21	-	-

**SICKLES**

**NEW HOLLAND WINDROWER 1100 HIGH PERFORMANCE HEADER 1112,1114,1116,1118,116 (14' & 16')**

OEM #	Length	No. Of Sections	Head	Head OEM #	Type	Section	Section OEM #	Riveted Order No	Riveted List	Bolted Order No	Bolted List
SST1247987	7' LH	(28)		247989	XH7TTCR		SSTJ7000	-		S35-2363	339.65
SST1247988	7' RH	(29)		247970	XH7TTCR		SSTJ7000	-		S35-2364	339.66
247987	7' LH	(28)		247989	<b>Tiger Shark™</b>					<b>S35-2521</b>	<b>172.72</b>
9619696	7' LH	(28)		247989	XHTSCR		604800	-		S35-2755	285.34
247988	7' RH	(29)		247990	<b>Tiger Shark™</b>					<b>S35-2523</b>	<b>170.99</b>
9619697	7' RH	(29)		247990	XHTSCR		604800	-		S35-2756	280.06
TS247988	7' RH	(29)		247990	XHTSCR		604921	S35-4040	140.29	-	-
XH7TS247987	7' LH	(28)		247989	XHSTSCRS		604921H	-		S35-2005	182.05
XH7TS247988	7' RH	(29)		247990	XHSTSCRS		604921H	-		S35-2006	182.05
858724	7' LH	(28)		247990	XHTSCR		604921H	-		S35-2755	285.34
858725	7' RH	(29)		247989	XHTSCR		604921H	-		S35-2756	280.06
264985	8' RH	(33)		247989	XHUSCR		604800	S35-4034	284.55	-	-
TS264987	8' LH	(32)		247989	XHTSCR		604921	S35-4036	150.30	-	-
TS264985	8' RH	(33)		247990	XHTSCR		604921	S35-4041	150.30	-	-
858722	8' LH	(32)		247989	XHTSCR		604921H	-		S35-2758	231.85
858723	8' RH	(33)		247990	XHTSCR		604921H	-		S35-2759	237.71

**NEW HOLLAND WINDROWER 907, 909, 910, 912, 1112, 1114, 1116, 1118, 116, 114, 1100**

OEM #	Length	No. Of Sections	Head	Head OEM #	Type	Section	Section OEM #	Riveted Order No	Riveted List	Bolted Order No	Bolted List	
264987	8' LH	(32)		858713	XH7TSCR		SS604921H	-		S35-2058	232.91	
264985	8' RH	(33)		858714	XH7TSCR		SS604921H	-		S35-2059	232.91	
HTS264987-S	8' LH	(32)		Less Head	XHTSCR		604921H	-		S35-2972	195.96	
HTS264985-S	8' RH	(33)		Less Head	XHTSCR		604921H	-		S35-2973	195.96	
HTS247987-S	7' LH	(28)		Less Head	XHTSCR		604921H	S35-4133	354.81	S35-2417	118.57	
HTS247988-S	7' RH	(29)		Less Head	XHTSCR		604921H	S35-4534	201.65	S35-2418	118.57	
706418	7' RH	(29)		Less Head	XHTSCR		604921	-		S35-2849	169.34	
706416	8' RH	(33)		Less Head	XHTSCR		604921	-		S35-2851	168.59	
SS706417	7' LH	(28)		Less Head	XH7TSCR		SS604921H	-		S35-2007	130.09	
SS706418	7' RH	(29)		Less Head	XH7TSCR		SS604921H	-		S35-2008	130.09	
139180	RH Knife Back Overlap Bar								S35-6075	18.77	-	-

**NEW HOLLAND WINDROWER MODELS 1475, 2200, 2300, 2450 AND 2550, HS SERIES HEADER 12HS, 14HS, 16HS**

OEM #	Length	No. Of Sections	Head	Head OEM #	Type	Section	Section OEM #	Riveted Order No	Riveted List	Bolted Order No	Bolted List
86509304	7' LH	(29)		Headless	XH7TSCR		SS604921H	-		S35-2049	137.41
86509305	7' RH	(29)		Headless	XH7TSCR		SS604921H	-		S35-2050	137.41
86509302	8' LH	(33)		Headless	XH7TSCR		SS604921H	-		S35-2233	201.78
86509303	8' RH	(33)		Headless	XH7TSCR		SS604921H	-		S35-2234	199.11
9826391	9' RH	(37)		9622855, 186617752	XH7TSCR		SS604921H	-		S35-2914	271.11
9826390	9' LH	(37)		9622854, 186617755	XH7TSCR		SS604921H	-		S35-2915	271.11
85605851	9' LH	(37)		Headless	XH7TSCR		SS604921H	-		S35-2063	248.52
86505852	9' RH	(37)		Headless	XH7TSCR		SS604921H	-		S35-2064	248.52
86616534	7' LH	(29)	Yes	9622854	XH7TSCR		SS604921H	-		S35-2037	206.12
					<b>Tiger Shark™</b>					<b>S35-2533</b>	<b>178.87</b>
Have Tomahawk Overlap Section				Headless	XH7TSCR					S35-1539	137.47
86616535	7' RH	(29)	Yes	9622855	XH7TSCR		SS604921H	-		S35-2038	206.12
					<b>Tiger Shark™</b>					<b>S35-2534</b>	<b>178.87</b>
Have Tomahawk Overlap Section				Headless	XH7TSCR					S35-1540	137.47
86502116	8' LH	(33)	Yes	9622854	XH7TSCR		SS604921H	-		S35-2039	225.74
					<b>Tiger Shark™</b>					<b>S35-2550</b>	<b>198.77</b>
86502117	8' RH	(33)	Yes	9622855	XH7TSCR		SS604921H	-		S35-2040	225.74
					<b>Tiger Shark™</b>					<b>S35-2551</b>	<b>195.89</b>
86616720	9' LH				<b>Tiger Shark™</b>		SS604921H	-		S35-8000	203.28
86616721	9' RH				<b>Tiger Shark™</b>		SS604921H	-		S35-8001	203.28

**UNIVERSAL SICKLES - NEW HOLLAND 2-1/16" SPACING**

Application	Description	Head Number	Riveted Order No.	Riveted List	Bolted Order No.	Bolted List
Mowers 450, 451, 455, 456, M/C, 460,	7" X 7TS Knf	Headless	-		S35-1038	94.93
461, 467, 469, 1469, 472, 477, 478, 479,	9" X 7TS Knf	Headless	-		S35-1039	111.45



## SPliced SICKLES - SINGLE DRIVE LESS HEAD

Fits NEW HOLLAND 3" SYSTEMS. COMBINES WITH 970, 971, 972, & 973 SINGLE DRIVE PLATFORMS.

Complete Sickle - Bolted, 14 Tooth Sections

OEM Number	HTSCR Section Number	No. of Sections	No. of Size	Segments			# Sections To Cut Off	Order No.	List
				5' LH Head Seg. S35-2820	5' Ext. S35-2825	2' Ext. S35-2824			
851663	694723	63	16'	1	2	1	4	S35-2837	484.53

Note: Use H15-0752 Head if needed.



### SPlice KIT

For 2-1/16" hole spacing. Kit contains 2 straps along with the bolts & nuts. For 200, 900 Series headers.

Order No.	List
C83-0755	22.80

## SPliced SICKLES - DOUBLE DRIVE LESS HEAD

Fits NEW HOLLAND 1.5" SYSTEMS. COMBINES WITH 970, 971, 972, & 973 DOUBLE DRIVE PLATFORMS

Complete Sickle

Section Number	No. of Sections	No. of Size	Segments					Order No.	List	
			5' LH Head Seg. S35-2507	5' LH Overlap Seg. S35-2508	5' RH Head Seg. S35-2509	5' RH Overlap Seg. S35-2510	2.5' Ext. Seg. S35-2511			5' Ext. Seg. S35-2277
SSTJ6700	50	25' LH	1	1	-	-	1	-	S35-2503	387.41
SSTJ6700	58	30' RH	-	-	1	1	-	1	S35-2506	373.94

Use H15-0060 LH Head, H15-0061 RH Head if needed. (For Tiger Jaw applications only.)

Use H15-0752 Head if needed. (For OEM 1.5" Systems only.)



### BOLTS FOR SPlice KITS

Bolts and nuts for splice kits listed above. 12 each per package.

Order No.	List
B55-0049D	8.74

### SICKLE HEAD

Fits FORD Mowers 14-280, 1, 2, 3, 515 Series. Replaces 242063.

Order No.	List
H15-0204	57.41



### SICKLE HEAD

Fits FORD Mower Conditioner 538.

Order No.	List
H15-0283	73.21



### SICKLE HEAD

Fits FORD Mowers 505 Series. Replaces 462378R1.

Order No.	List
H15-0281	49.38



### SICKLE HEAD

Fits NEW HOLLAND Mowers 450 (S/N 87765-) 455 (S/N 88847), 451 & 456. Replaces 858740, 143603.

Order No.	List
H15-0208	85.98



### SICKLE HEAD

Fits NEW HOLLAND Mower Conditioner 460, 461, 467, 469, 490 (Up to S/N 259714). Replaces 86507377.

Order No.	List
H15-0866	91.74



### SICKLE HEAD

Fits NEW HOLLAND Mower Conditioners 472, 477 & 478. Replaces 577868.

Order No.	List
H15-0863	106.68



### SICKLE HEAD

Fits NEW HOLLAND Mower Conditioners 488 & 479 490 (S/N 259715-), 1469 (S/N 220947-). Replaces 577867.

Order No.	List
H15-0862	97.90



### SICKLE HEAD

Fits NEW HOLLAND Mower Conditioners 474, 489, 492, 1465. Replaces 289488.

Order No.	List
H15-0488	118.72





**SICKLE HEAD**  
Fits NEW HOLLAND Mower Conditioners. Tiger Tooth 479, 488, 1469 (S/N 220947), TT577867.

<u>Order No.</u>	<u>List</u>
H15-0579	104.99



**SICKLE HEAD - LEFT HAND**  
Fits NEW HOLLAND Windrowers 1100, 1112, 1118, 1114, 1116. Replaces 858713. Not Pivot Tongue.

<u>Order No.</u>	<u>List</u>
H15-0027	70.65



**SICKLE HEAD - LEFT HAND**  
Fits NEW HOLLAND 1475, 2450 & 2550. Replaces 9622854.

<u>Order No.</u>	<u>List</u>
H15-0355	191.63



**SICKLE HEAD - RIGHT HAND**  
Fits NEW HOLLAND 1475, 2450 & 2550. Replaces 9622855.

<u>Order No.</u>	<u>List</u>
H15-0356	77.78



**SICKLE HEAD**  
Fits NEW HOLLAND 44, 45, 46, 47. Replaces MA999.

<u>Order No.</u>	<u>List</u>
H15-0257	73.67

**1-YEAR WARRANTY ON ALL ITEMS!**

**SICKLE HEAD**  
Fits VERSATILE Windrower 10, 103, 400, 4400. Replaces SWA28509.

<u>Order No.</u>	<u>List</u>
H15-0458	69.18



**HEAD BUSHING**  
Fits NEW HOLLAND Mowers 450 (S/N 87764-) 455 (S/N 88846 & Up), 1496, Windrower 1499. Replaces 127610.

<u>Order No.</u>	<u>List</u>
B82-0062B	26.82



**HEAD BUSHING**  
Fits NEW HOLLAND Mower Conditioners 460, 461, 467, 469, 490 (S/N - 259714), 1469. Replaces 134182.

<u>Order No.</u>	<u>List</u>
B82-0381B	35.31



**HEAD BUSHING**  
Fits NEW HOLLAND Mower Conditioners 472, 477, 478, 479, 488, 490, 495, 1495. Replaces 254132.

<u>Order No.</u>	<u>List</u>
B82-0426B	39.74



**HEAD BUSHING**  
Fits NEW HOLLAND Mower Conditioners 905, 907, 909, 910, 912, 1100, 1112, 1114, 1116, 114, 116, 1118. Replaces 76417.

<u>Order No.</u>	<u>List</u>
B82-0068B	31.59

**BUSHING ASSEMBLY**  
Fits NEW HOLLAND Mower Conditioners 474, 489, 492, 1465, Combine 972, 973. Replaces 612408A.



<u>Order No.</u>	<u>List</u>
B82-0211B	31.86

**HEAD BUSHING - SILENT BLOCK**  
Fits VERSATILE Windrowers 10, 103, 400, 4400. Replaces SW1740.



<u>Order No.</u>	<u>List</u>
B82-0437B	21.89

## FORGED STEEL GUARD

Fits NEW HOLLAND Mowers. Replaces 219190, FS93-2, BU218, FS93-2DH.

Order No	List
G81-0184	9.37
G81-0144 - Double Heat Treat	10.65



## FORGED STEEL GUARD

Fits NEW HOLLAND Combines with floating bars (LOVE). Replaces FC90-2, BU275.

Order No	List
G81-0196	13.40



## FORGED STEEL GUARD

Fits NEW HOLLAND Windrowers and Mower Conditioners. Replaces FS81-2, BU215H, BU215A, HA215DH, FS81DH.

Order No	List
G81-0155	9.37
G81-0098 - Double Heat Treat	11.23
G81-0231 - Boron	11.23



## FORGED STEEL GUARD

Fits NEW HOLLAND Mower/Cond. & Windrowers. Replaces 049312, FS 86-2, HA250. Stub guard.

Order No	List
G81-0120	13.18



## FORGED STEEL GUARD

Fits NEW HOLLAND Windrowers. Replaces FT 77-2, HA260, BU260. Tie guard

Order No	List
G81-0085	14.40



## FORGED STEEL GUARD

Fits NEW HOLLAND 536. Replaces 110-32327, 110-32342.

Order No	List
G81-0197	10.55



## FORGED STEEL GUARD

Fits NEW HOLLAND Windrowers, Mower Conditioners, 971, 973, 71C, 73C, 74C Headers. Replaces 86615983, 87042360, 215DH. Center Guard

Order No	List
G81-0093	18.75



## FORGED STEEL GUARD

Fits NEW HOLLAND Mower Conditioner 535. Replaces FS72-2, BU280, 290385.

Order No	List
G81-0065	18.93



## FORGED STEEL GUARD

Fits NEW HOLLAND Windrowers, Mower Conditioner 538. Replaces FC85-2, BU210, 483500R3.

Order No	List
G81-0183	10.70



## FORGED STEEL GUARD

Fits NEW HOLLAND Mower Conditioners. Replaces FS92-2, BU206, 110-323275.

Order No	List
G81-0140	19.14



## FORGED STEEL GUARD

Fits NEW HOLLAND 740CR, 880CF Combine Heads. Replaces 87702973 BU973.

Order No	List
G81-0973	14.12



## PLASTIC BEARING KIT

Includes 6 caps, 6 bases, U-Bolts and 12 nuts.

Application: Reels with Wood Bats used on Case-New Holland 810, 820.

Order No.	List
B15-0915	27.47



## PLASTIC BEARING KIT

Includes 12 bearing halves, 6 bolts, and 6 nuts.

Application: Pipe Reels with Plastic Tines used on Case-New Holland 1010, 1020.

Order No.	List
B15-0925	24.64

## FORGED STEEL HEAD GUARD

Fits NEW HOLLAND 740CR, 880CF Combine Heads. Four used by drive head. Replaces 87702974 and BU974.

Order No	List
G81-0974	14.12



## FORGED STEEL GUARD

Fits VERSATILE Windrowers. Replaces FS67-2, BU290, SW 1605.

Order No	List
G81-0197	10.55



## MALLEABLE GUARDS

Fits 7/16" Bars. Fits NEW HOLLAND Mowers.

Replaces	Description	Order No	List
DM700, T27293	Center Guard	G81-0803	7.05
DM700-R	Outer Guard	G81-0805	9.95
FD800	Center Guard	G81-0807	8.62
MC2041Z	Center Guard	G81-0830	9.66



## GUARD PLATE

Fits NEW HOLLAND/FORD Mowers. Use with G81-0778, G81-0821. Replaces 142570.

Order No.	List
P44-0603	15.44

**DISC MOWER KNIVES**

Fits NEW HOLLAND 408, 411, 412, 415

Length: 4.21"	Degree of Twist: 13	Hole Diameter: .72
Width: 1.78	Thickness: 0.169	Center Of Hole To Back Edge: .80

OEM Number	Style	Shape	Bolt Order No	6 Blades Order No	List	25 Blades Order No	List
853819	4	RH Twisted	B55-0344D	B45-6568D	9.83	B45-6568	39.24
853820	4	LH Twisted	B55-0344D	B45-6569D	9.83	B45-6569	39.24



**DISC MOWER KNIVES**

Fits NEW HOLLAND 411 TO 711915, 453, 463.

Length: 4.72"	Degree of Twist: 13	Hole Diameter: .73
Width: 1.79	Thickness: 0.170	Center Of Hole To Back Edge: .78

OEM Number	Style	Shape	Bolt Order No	6 Blades Order No	List	25 Blades Order No	List
784220	4	LH Twisted	B55-0358D	B45-6565D	10.41	B45-6565	40.64
784221	4	RH Twisted	B55-0358D	B45-6566D	10.41	B45-6566	40.64



**DISC MOWER KNIVES**

Fits NEW HOLLAND ALL 442 & 462.

Length: 3.78"	Degree of Twist: 0	Hole Diameter: .64
Width: 1.55	Thickness: 0.110	Center Of Hole To Back Edge: .71

OEM Number	Style	Shape	Bolt Order No	6 Blades Order No	List	25 Blades Order No	List
274230	1	Flat	B55-0358D	B45-6175D	8.62	B45-6175	33.54



**DISC MOWER KNIVES**

Fits NEW HOLLAND 462 TO 51121643.

Length: 3.66"	Degree of Twist: 13	Hole Diameter: .64
Width: 1.60	Thickness: 0.116	Center Of Hole To Back Edge: .80

OEM Number	Style	Shape	Bolt Order No	6 Blades Order No	List	25 Blades Order No	List
274096	4	LH Twisted	B55-0358D	B45-6996D	10.18	B45-6996	30.57
274097	4	RH Twisted	B55-0358D	B45-6997D	10.18	B45-6997	35.62



**DISC MOWER KNIVES**

Fits NEW HOLLAND 462 AFTER 51121643, 452, 442

Length: 3.75"	Degree of Twist: 13	Hole Diameter: .64
Width: 1.78	Thickness: 0.140	Center Of Hole To Back Edge: .75

OEM Number	Style	Shape	Bolt Order No	6 Blades Order No	List	25 Blades Order No	List
766726	4	LH Twisted	B55-0358D	B45-6122D	9.30	B45-6122	39.41
766727	4	RH Twisted	B55-0358D	B45-6123D	9.30	B45-6123	39.41



**DISC MOWER KNIVES**

Fits NEW HOLLAND 615, 616, 617, 720HD, 750HD, 1409, 1410, 1411, 1412, 1431, 1432, 1441, 1442, 2331, 2332, 2353, 2355, 2358, DCX101, DCX131, DCS161, RDX161, H6730, H6740, H6750, H7220, H72230H, H7320, H7330.

Length: 4.21"	Degree of Twist: 13	Hole Diameter: .90
Width: 1.90	Thickness: 0.160	Center Of Hole To Back Edge: .75

OEM Number	Style	Shape	Bolt Order No	6 Blades Order No	List	25 Blades Order No	List
9847684		LH Twisted	N/A	B45-6721D	10.16	B45-6721D	39.58
9847683		RH Twisted	N/A	B45-6720D	10.16	B45-6720D	40.79



**DISC MOWER KNIVES - 18 DEGREE TOP BEVEL**

Fits NEW HOLLAND 3204, 3205, 3260, 3309

Length: 4.79"	Degree of Twist: 18	Hole Diameter: .89
Width: 1.88	Thickness: 0.165	Center Of Hole To Back Edge: .78

OEM Number	Style	Shape	Bolt Order No	6 Blades Order No	List
113385A1	5	LH Twisted	B55-0355D	B45-6576D	10.15
113384A1	5	RH Twisted	B55-0355D	B45-6577D	10.15

**HOLD DOWN CLIPS  
NON-ADJUSTABLE**



Fits NEW HOLLAND Bolted sickles with head clearance. Steel.

Style	Order No.	List
Low Arch	C45-0692	3.57
High Arch	C45-0693	4.79



Fits NEW HOLLAND Windrowers with guard G81-0120. Steel.

Style	Order No.	List
Low Arch	C45-0502	6.59
High Arch	C45-0503	10.03



Fits VERSATILE with riveted sickles. Steel. Hardened.

Style	Order No.	List
Low Arch	C45-0419	2.97



Fits VERSATILE with bolted sickles. Steel. Hardened.

Style	Order No.	List
Low Arch	C45-0951	4.09

**1-YEAR WARRANTY ON ALL ITEMS!**

## DISC MOWER KNIVES - 18 DEGREE BOTTOM BEVEL

Fits NEW HOLLAND 725, 8850, DC515, 8309, 8312, 8315

Length: 4.21"	Degree of Twist: 18	Hole Diameter: .73
Width: 1.88	Thickness: 0.163	Center Of Hole To Back Edge: .78

OEM Number	Shape	Bolt Order No	6 Blades Order No	List	25 Blades Order No	List
700715575	LH Twisted	B55-0342D	B45-6572D	10.96	B45-6572	39.90
700715576	RH Twisted	B55-0342D	B45-6573D	10.96	B45-6573	39.90

## DISC MOWER KNIVES - 18 DEGREE TOP BEVEL

Fits NEW HOLLAND 725, 8850, DC515, 8309, 8312, 8315

Length: 4.21"	Degree of Twist: 18	Hole Diameter: .73
Width: 1.89	Thickness: 0.157	Center Of Hole To Back Edge: .75

OEM Number	Shape	Bolt Order No	6 Blades Order No	List	25 Blades Order No	List
700715575	LH Twisted	B55-0342D	B45-6725D	11.75	B45-6725	40.79
700715576	RH Twisted	B55-0342D	B45-6726D	11.75	B45-6726	40.79

## GRASS BOARD

Fits all mowers.



Order No	List
B52-0615	44.40

## WEAR PLATES



For all NEW HOLLAND Mowers, Swathers, Combines. Replaces W50, 141021. 5-7/8" long. Slotted holes with 3" spacing.

Order No.	List
P44-0591	2.95
P44-0591D*	10.27

\*Display Pack of 2.



For all NEW HOLLAND Combines with floating bars. 6" full length. Replaces 271967, 26616.

Order No.	List
P44-0417	2.53



24" length with 1-1/2" spacing. Heat treated. Replaces FLW24HT.

Order No.	List
P44-0200	15.14

## RAKE WHEELS

Heavy Duty, .275. Fits Sitrex, Case, H&S, M&W, New Holland, Westward & Others. Painted Creme Overall diameter: 55"

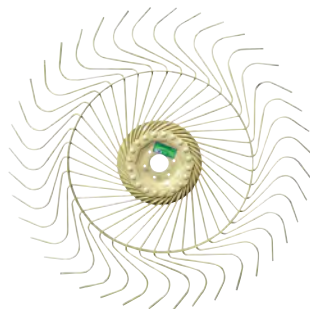

Description	Order No	List
Right Hand	W16-0801	111.98
Left Hand	W16-0802	111.98

Replacement Tine Part Number T16-0815D.

## HOLD DOWN CLIPS ADJUSTABLE

Fits most NEW HOLLAND Mowers, Conditioners and Swathers except Verstile. Cast.



Style	Order No.	List
Low Arch	C45-0006	21.39
High Arch	C45-0007	21.39

Fits most NEW HOLLAND Combines, Mowers and Windrowers except Versatile, Hart-Carter & Love. Stamped



Style	Order No.	List
Low Arch	C45-0040	5.65

## RAKE WHEELS

Heavy Duty, .275. Fits Sitrex, Case, H&S, M&W, New Holland, Westward & Others. Painted Creme Overall diameter: 55"



## HUB ASSEMBLY

With bearing for all wheels listed at left. Pilot: 3.21". Bolt circle: 5.12". 13mm bolt required

Order No.	List
H16-1000	42.58



## RAKE WHEEL SPRING

Fits H&S and other Wheel Rakes using lift springs on wheels. 1 used per hay turning wheel. 11" long. 1-7/8" OD. 1-1/2" ID .238 Diameter wire

Order No.	List
S16-1000	13.08

## PITMAN WOOD - 37-11/16"

Fits NEW HOLLAND Mowers 14-92, 501.

Order No.	List
P38-0520	30.48

## PITMAN WOOD - 46-7/16"

Fits NEW HOLLAND Mowers 14-93.

Order No.	List
P38-0525	38.23

## PITMAN WOOD - 37-1/2"

Universal. 37-1/2" x 1-7/16" x 1-1/8".

Order No.	List
P38-0560	24.25

## BALE COUNTER

Bale counter, reads up to 99,999. 4-hole mounting plate, push button reset, adjustable side arm. Fits most balers.

Order No	List
T55-0002	25.30





**RUBBER MOUNT RAKE TOOTH**

For JOHN DEERE Rakes 640, 650, 660, 670, 672, 662, 652, 896A. Replaces 1/4 x 3/4 LPK, RMT-1, AE47389. Right hand.

<b>Order No.</b>	<b>List</b>
T16-0182	2.07



**RIGHT HAND RAKE TOOTH**

For NEW HOLLAND Rakes 56B, 27, 259, 216, 256, 258, 260, 269 & 216. Replaces 130941R.

<b>Order No.</b>	<b>List</b>
T16-0166	3.42



**LEFT HAND RAKE TOOTH**

For NEW HOLLAND Rakes 216, 258, 259, 260. Replaces 65668L.

<b>Order No.</b>	<b>List</b>
T16-0154	3.60



**RAKE TOOTH**

For NEW HOLLAND Rakes 55, 56B, 57, 256, 258, 259, 260. Replaces 64562. Left hand rakes.

<b>Order No.</b>	<b>List</b>
T16-0370	2.20

Clip for T16-0370. 10 per bag.

<b>Order No.</b>	<b>List</b>
C45-0493B	9.52

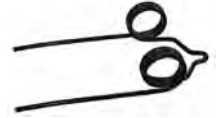

**RAKE TOOTH**

For FORD Rakes. Replaces 146545.

<b>Order No.</b>	<b>List</b>
T16-0340	4.83

**Get Online With Herschel Parts!**

**HERSCHELPARTS.com**

You can shop 24 hours a day. 7 Days A Week!



**REEL TOOTH**

For NEW HOLLAND Mower Conditioners and Windrowers 460, 461, 467, 468, 472, 474, 488, 492, 903, 907, 909, 912, 1100, 1112, 477, 479. Replaces 76517.

<b>Order No.</b>	<b>List</b>
T16-0032	4.15



**BALER TOOTH**

For NEW HOLLAND Pickup on Super Sweep Baler & Large Round Balers. Replaces 131673, 86551419.

<b>Order No.</b>	<b>List</b>
T16-0162	3.24



**BALER TOOTH**

For NEW HOLLAND Balers 78 & Super 68, 273, 276. Replaces 127566.

<b>Order No.</b>	<b>List</b>
T16-0158	2.76

- PATENTED 2 PIECE DESIGN.
- SAVE MONEY! REPLACE ONLY THE TINE.



MADE IN THE USA



**HERSCHEL 6" 2-PIECE POLY TINES FOR PIPE REELS**

Fits NEW HOLLAND 71C, 73C, 972 & 973. 1/2" Nub.

Description	Pkg. Qty.	Order No.	List
Tine & Clamp	100/Box	T16-0740	198.88
Tine & Clamp	10/Box	T16-0745	21.80
Tine ONLY	100/Box	T16-0750	130.64

**NYLON FLEX TINE**

For New Holland Reel-bat-tine with wood bats. Replaces N66A. 1 mounts to front of bat. 100 per box.

<b>Order No.</b>	<b>List</b>
T16-0183	189.12

**NYLON FLEX TINE**

For New Holland Reel-bat-tine. Replaces N67A. 100 per box.

<b>Order No.</b>	<b>List</b>
T16-0767	165.82

**1-YEAR WARRANTY ON ALL ITEMS!**



**2 PIECE M/L REEL TINE**

Replaces 782551, 1989438C1, AH136689, AH153175. 100 per box. 3/8" Nub.

<b>Order No.</b>	<b>List</b>
T16-0720	175.64



**2 PIECE M/L REEL TINE**

Replaces 782226, 1989438C1, AH136689, AH153175. 10 per bag. 3/8" Nub.

<b>Order No.</b>	<b>List</b>
T16-0715	19.03



**M/L REEL TINE**

For T16-0715 and T16-0720. No clamps. Replaces HA100MLT. 100 per box. 3/8" Nub.

<b>Order No.</b>	<b>List</b>
T16-0725	128.83

**REPLACEMENT SCREW**

For T16-0715 and T16-0720. No clamps. Replaces HA20SC. 20 per box.

<b>Order No.</b>	<b>List</b>
B55-0096D	2.40

**HAMMER RIVET TOOL**

For Drive Rivets



<b>Order No.</b>	<b>List</b>
T55-0812	30.72

# NEW IDEA

HERSCHEL sections are made in the USA from high quality boron steel. Heat-treated for long life. Sections are extra heavy (.116") and chrome unless stated otherwise.

## SECTION TYPES

7TS = Super 7® Top Serrated  
 SM = Smooth  
 US = Under Serrated - 14 Tooth  
 TS = Top Serrated - 14 Tooth  
 TT = Tiger Tooth  
 TJ = Tiger Jaw  
 SRK = Tiger Shark™



**SECTION - XSM**  
 Fits NEW IDEA Mowers and Conditioners. Section is 3" x 3-1/4". Use 9/16 OH Rivet. Sold 10 sections per pack. M333-1/2.

Replaces Number	Order No	List
0577HS	S20-1145	12.58



**SECTION - XHTSCR**  
 Fits NEW IDEA Mowers and Conditioners. Section is 3" x 3-1/4". Use 5/8 OH Rivet. Sold 10 sections per pack.

Replaces Number	Order No	List
714604	S20-4719	18.01



**SECTION - XHUSCR**  
 Fits NEW IDEA Mowers and Conditioners. Section is 3" x 3-1/4". Use 9/16 OH Rivet. Sold 10 sections per pack.

Replaces Number	Order No	List
0188HS	S20-6339	13.30



**SECTION - XHUS**  
 Fits NEW IDEA Mowers and Conditioners. Section is 3" x 3-1/4". Use 9/16 OH Rivet. Sold 10 sections per pack.

Replaces Number	Order No	List
OU577HS	S20-5107	10.58



**PITMAN WOOD - 35-7/8"**  
 Fits NEW IDEA Mowers except 253.

Order No.	List
P38-0550	32.56

**Get Online With Herschel Parts!**  
**HERSCHELPARTS.com**  
 You can shop 24 hours a day.  
 7 Days A Week!



**7' RIVETED SICKLE - XHUS SECTIONS**  
 Fits NEW IDEA Mowers 10, 20, 30, 40, 41, 250, 251, 252, 253, 254, 255.

Section OEM# OU577HS  
 Head OEM# 05H

OEM #	# of Sections	Order No	List
OU286HSA	28	S35-3536	208.07



**9' RIVETED SICKLE - XHUS SECTIONS - HEADLESS**  
 Fits NEW IDEA Mower Conditioners 290.

Section OEM# OU577HS

OEM #	# of Sections	Order No	List
290627S	35	S35-3620	140.02



**RIVETED SICKLES - XHUS SECTIONS**  
 Fits NEW IDEA Mower Conditioners 507, 5107, 509, 5109.

Section OEM# OU577HS  
 Head OEM# 824594C1

OEM #	Length	# of Sections	Order No	List
101987C91	7'	28	S35-3293	282.48
101988C91	9'	36	S35-3292	195.16



**RIVETED SICKLES**  
 Fits NEW IDEA Mowers 521 & 522.

Section OEM# 826724C2  
 Head OEM# 56692C91

OEM #	Length	# of Sections	Order No	List
462381R93	7'	28 - XHSM	S35-3668	151.23
		Tiger Shark™	S35-2500	151.06
463182R93	9'	36 - XHSM	S35-3672	136.64
463159R93	9'	36 - XHUS	S35-3669	115.53
		Tiger Shark™	S35-2512	149.54

**WHY TRY TIGER SHARK™ SECTIONS?**

1. Serrated teeth allow more cutting surface.
2. They last longer, cut faster.
3. Cuts equally well in soybeans, alfalfa, grass hay, wheat, etc.

**Customer Testimonial:**  
 "I cut over 1000 acres of soybeans with the same *Herschel Tiger Shark™* sections. They stayed sharper longer and lasted longer than any section I have used." - Roger Woodruff, Warren Co. Iowa





**12-1/4' RIVETED SICKLE - XHUSCR SECTIONS**  
 Fits NEW IDEA Mower Conditioner 512

Section OEM# O1188HS  
 Head OEM# ZA502562

OEM #	# of Sections	Order No	List
BN502825	48	S35-2293	344.71



**14-1/4' RIVETED SICKLE - XHUSCR SECTIONS**  
 Fits NEW IDEA Mower Conditioner 514

Section OEM# O1188HS  
 Head OEM# ZA502562

OEM #	# of Sections	Order No	List
BN502826	56	S35-2294	358.48

**1-YEAR WARRANTY ON ALL ITEMS!**

**SICKLE HEADS**



Fits NEW IDEA Mowers 10, 20, 30, 40. Replaces 045H.

Order No.	List
H15-0253	126.45

Fits NEW IDEA Mower Conditioners 512, 514. Replaces ZA502562.

Order No.	List
H15-0292	95.62

Fits NEW IDEA Mowers 521, 522. Replaces 462378R11.

Order No.	List
H15-0281	49.38

**MALLEABLE GUARDS**

Fits 7/16" Bars.

G81-0803



Replaces	Description	Order No	List
DM700, 25314	Center Guard	G81-0803	7.05
DM700-R	Outer Guard	G81-0805	9.95

Fits all NEW IDEA Mowers 521 & 522.

Replaces	Description	Order No	List
MC2041Z	Center Guard	G81-0830	9.66

G81-0830

**RAKE TOOTH**

For NEW IDEA Rake 404 Wheel Type. Replaces 400033, 0633ME, 782ME. 50 per box.



Order No.	List
T16-0368	5.35



**RAKE TOOTH**

For NEW IDEA Rakes 49, 400, 402, 403. Replaces 400341.

Order No.	List
T16-0370	2.20

Clip for T16-0370. 10 per bag.

Order No.	List
C45-0493B	9.52

**FORGED STEEL GUARD**

Fits NEW IDEA Mowers 521 & 522. Replaces FS65-2, HA270.



Order No	List
G81-0035	13.05

**FORGED STEEL GUARD**

Fits NEW IDEA Mowers 521 & 522. Replaces FS66-2, HA240A, 714611.



Order No	List
G81-0191	8.79

**DISC MOWER KNIVES**

Fits NEW IDEA 5209, 5212, 5312, 5406, 5407, 5408, 5408, 5410

Length: 4.76"	Degree of Twist: 13	Hole Diameter: .89
Width: 1.88	Thickness: 0.165	Center Of Hole To Back Edge: .78



OEM Number	Style	Shape	Bolt Order No	6 Blades Order No	List	25 Blades Order No	List
527746	5	RH Twisted	B55-0355D	B45-6563D	10.51	B45-6563	41.18
527747	5	LH Twisted	B55-0355D	B45-6564D	10.51	B45-6564	41.18

**FORGED STEEL GUARD**

Fits NEW IDEA Combine Uni Harvester Header No 815 thru 820. Replaces FS66-DH, HA245DH Double Heat Treated.



Order No	List
G81-0042	13.92

**DISC MOWER KNIVES - 13 DEGREE TOP BEVEL**

Fits NEW IDEA 5209, 5212, 5406, 5407, 5408, 5409, 5410, 526, 527, 528

Length: 4.72"	Degree of Twist: 13	Hole Diameter: .73
Width: 1.86	Thickness: 0.163	Center Of Hole To Back Edge: .78



OEM Number	Style	Shape	Bolt Order No	6 Blades Order No	List	25 Blades Order No	List
526216	5	LH Twisted	B55-0357D	B45-6992D	11.07	B45-6992	41.74
526215	5	RH Twisted	B55-0357D	B45-6993D	11.07	B45-6993	41.74

**FORGED STEEL GUARD**

Fits NEW IDEA Mower Conditioner 290. Replaces FS2-2, HA280, 290835.



Order No	List
G81-0065	18.93

**DISC MOWER KNIVES - 13 DEGREE TOP BEVEL**

Fits Case-IH 5070, 5512, 5515, 6070

Length: 4.21"	Degree of Twist: 13	Hole Diameter: .72
Width: 1.78	Thickness: 0.169	Center Of Hole To Back Edge: .80



OEM Number	Style	Shape	Bolt Order No	6 Blades Order No	List	25 Blades Order No	List
700712888	4	RH Twisted	B55-0344D	B45-6568D	9.83	B45-6568	39.24
700712889	4	LH Twisted	B55-0344D	B45-6569D	9.83	B45-6569	39.24

Length: 4.21"	Degree of Twist: 13	Hole Diameter: .73
Width: 1.86	Thickness: 0.175	Center Of Hole To Back Edge: .78



OEM Number	Style	Shape	Bolt Order No	6 Blades Order No	List	25 Blades Order No	List
	5	RH Twisted	B55-0342D	B45-6559D	9.39	B45-6559	37.96
	5	LH Twisted	B55-0342D	B45-6560D	9.39	B45-6560	37.96

**FORGED STEEL GUARD**

Fits NEW IDEA Combines 71, 713, 715. Replaces FC90-2, HA240A, 714611, HA245. Center guard.



Order No	List
G81-0192	9.38

# OWATONNA/PRAIRIE STAR

HERSCHEL sections are made in the USA from high quality boron steel. Heat-treated for long life. Sections are extra heavy (.116") and chrome unless stated otherwise.

## SECTION TYPES

7TS = Super 7® Top Serrated      TT = Tiger Tooth  
 SM = Smooth                              TJ = Tiger Jaw  
 US = Under Serrated - 14 Tooth      SRK = Tiger Shark™  
 TS = Top Serrated - 14 Tooth



### SECTION - XHTSCR

Fits OWATONNA/PRAIRIE STAR Windrowers 180, 196, 197, 200, 206, 262, 265, 270, 275, 280, 282, 281, 285. Section is 3" x 3-1/4". Uses 1/2 OH rivet. Sold 10 sections per pack. Replaces 340-16457.

Order No	List
S20-4277	15.39



### SECTION - XHTTCR

Fits OWATONNA/PRAIRIE STAR Windrowers 180, 196, 197, 200, 206, 262, 265, 270, 275, 280, 282, 281, 285. Section is 3" x 3-1/4". Uses 5/8 OH rivet. Sold 10 sections per pack. Replaces TT049254.

Order No	List
S20-4639	17.63



### SECTIONS

Fits OWATONNA/PRAIRIE STAR Windrowers 180, 196, 197, 200, 206, 262, 265, 270, 275, 280, 282, 281, 285. Section is 3" x 3-1/4". Uses 5/8 OH rivet. Sold 10 sections per pack.

### OEM

Number	Application	Design	Order No.	List
SS340-32015	XH7TS	B+	S20-3325	10.54
SS340-32015CR	XH7TSCR	B+	S20-4268	12.75
340-32049	XHUS	B-	S20-5107	10.58
340-32049 CR	XHUSCR	B-	S20-6339	13.30

### SICKLES - HEADLESS

Fits OWATONNA/PRAIRIE STAR WINDROWERS 208, 216, 229, 235, 255, 260, 265, 270, 275, 280, 282, 285, 281, 800, 900, 2650, 2240, 2270.

OEM #	Length	# of Sections	Section OEM #	Bolted Order No	List
340-32020	14'	57 - XHTS	340-32015	S35-1162	262.50



### BOLTED SICKLES - XH7TSCR SECTIONS HEADLESS

Fits MACDON WINDROWERS AND DRAPERS.

Section OEM# SS34390CR

OEM #	Length	Order No	List
33704	18'	S35-2262	354.08
43074	21'	S35-2253	351.47
43076	4' Ext., use w/S35-2253	S35-2254	182.37
43077	9' Ext., use w/S35-2253	S35-2255	263.55

### GUARD

Raised Trash Bar. Fits OWATONNA/PRAIRIE STAR Windrowers and Mower Conditioners. Replaces OEM 110-32327, 110-32342, FS92-2.

Order No	List
G81-0140	19.14



### GUARD BOLT- 1/2" X 1-1/2"

No. 3 Head (N/C Black) Gr. 5 Hardened (With Nuts). Use with guard 110-10657. Replaces 030-10659, 030-10642. 50 bolts/nuts per package.

Order No	List
B55-0295	13.60



### GUARD BOLT- 7/16" X 2"

Carriage Head (Plated) Gr. 5 Hardened (With Flange Lock Nuts). Use with guard 110-10657. Replaces 030-31517. 25 bolts/nuts per package.

Order No	List
B55-0200	29.71





HERSCHEL sections are made in the USA from high quality boron steel. Heat-treated for long life. Sections are extra heavy (.116") and chrome unless stated otherwise.

**SECTION TYPES**

- 7TS = Super 7® Top Serrated
- SM = Smooth
- US = Under Serrated - 14 Tooth
- TS = Top Serrated - 14 Tooth
- TT = Tiger Tooth
- TJ = Tiger Jaw
- SRK = Tiger Shark™



**SECTION - XHUS**  
Fits ROWSE Mowers. Section is 3" x 3-1/4". Use 9/16 CS Rivet. Sold 10 sections per pack.

Replaces  

Number	Order No	List
M22831, 29875	S20-5107	10.58



**SECTION - XHSM**  
Fits ROWSE Mowers. Section is 3" x 3-1/4". Use 9/16 CS Rivet. Sold 10 sections per pack.

Replaces  

Number	Order No	List
M3331/2	S20-1145	12.58

**SICKLE HEAD**  
Fits ROWSE CURRENT MOWERS. Replaces 143603.



Order No	List
H15-0208	85.98



**SICKLES**  
Fits ROWSE CURRENT MOWERS.

Section OEM# 29875  
Head OEM# 143603

OEM #	Length	# of Sections	Riveted		Bolted	
			Order No	List	Order No	List
228435	7'	29 - XHUS	S35-3884	121.76		
228434	9'	35 - XHUS	S35-3885	158.98	S35-1704	199.30
4BN228434		Tiger Shark™	S35-2552	175.67		

**SICKLE HEAD**  
Fits ROWSE OLDER MOWERS. Replaces 462378R11.



Order No	List
H15-0281	49.38



**SICKLES**  
Fits ROWSE OLDER MOWERS.

Head OEM# 462378R1

OEM #	Length	# of Sections	Section OEM	Riveted		Bolted	
				Order No	List	Order No	List
462381R91	7'	28 - XHSM	M3331/2	S35-3668	151.23		
462380R91, BN462380R91	7'	28 - XHUS	M22831	S35-3667	110.63	S35-2500	151.06
463182R91	9'	35 - XHSM	M3331/2	S35-3672	136.64	S35-1281	173.36
463159R91, BN463159R91	9'	35 - XHUS	M22831	S35-3669	115.53	S35-2500	151.06
		Tiger Shark™				S35-1714	158.40
						S35-2512	149.54

**FORGED STEEL GUARD**  
Fits ROWSE CURRENT MOWERS. Replaces 219190, FS93-2, BU218, FS93-2DH, HA216, HA216DH.



Order No	List
G81-0184	9.37
G81-0144 - Double Heat Treat	10.65

**FORGED STEEL GUARD**  
Fits ROWSE OLDER MOWERS. Replace FS65-2, HA270.



Order No	List
G81-0035	13.05

**SICKLE**  
Fits ROWSE OLDER MOWERS.

Head OEM# 56992C91

OEM #	Length	# of Sections	Riveted		Bolted	
			Order No	List	Order No	List
1281291C29	9'	35 - XHTS	S35-3940	117.60	S35-1103	164.52

HERSCHEL sections are made in the USA from high quality boron steel. Heat-treated for long life. Sections are extra heavy (.116") and chrome unless stated otherwise.

## WHY TRY TIGER SHARK™ SECTIONS?

1. Serrated teeth allow more cutting surface.
2. They last longer, cut faster.
3. Cuts equally well in soybeans, alfalfa, grass hay, wheat, etc.



### Customer Testimonial:

I cut over 1000 acres of soybeans with the same *Herschel Tiger Shark™* sections. They stayed sharper longer and lasted longer than any section I have used. - Roger Woodruff, Warren Co. Iowa



### SECTIONS

Fits SCHUMACHER Heads with Easy Cut System. Sold 10 sections per pack.

The *Tiger Shark™* section can be used in place of the sections listed below.

OEM #	Description	Order No	List
	<i>Tiger Shark™</i>	<i>S20-8498</i>	<i>18.12</i>
26208CR, 420-100-058	XH7TSCR	S20-4498	17.20
420-100-058	XH7TS	S20-3513	15.72

### SECTION TYPES

- 7TS = Super 7® Top Serrated      TT = Tiger Tooth  
 SM = Smooth      TJ = Tiger Jaw  
 US = Under Serrated - 14 Tooth      SRK = Tiger Shark™  
 TS = Top Serrated - 14 Tooth

### SECTION BOLT/NUT

Replaces 420100012, 61711. M6-1.0x16. 50 per package.



Order No.	List
B55-0075D	23.53

### SECTION FLANGE NUT

Replaces 01106001, 61713. 20 per package. M6-16



Order No.	List
N83-0075D	7.70



### SPLICE KIT

Order No.	List
C83-0500	19.40

### SPliced SICKLES FOR SCHUMACHER EASY CUT SYSTEMS

Sickles are headless



#### SICKLES WITH SUPER 7® SECTIONS(CHROME)

Section Type	Size	# of Sections	Order No.	List
H7TSCR	20	82	S35-2520	400.78
H7TSCR	25	102	S35-2525	498.54
H7TSCR	30	122	S35-2531	593.99
H7TSCR	35	142	S35-2535	687.16
XH7TSCR	36'	146	S35-2544	706.50
XH7TSCR	40'	146	S35-2546	746.04

#### SICKLES WITH TIGER SHARK™ SECTIONS(CHROME)

Section Type	Size	# of Sections	Order No.	List
XHSRKR	30	122	S35-2637	593.99
XHSRKR	36	146	S35-2638	706.50

### 12MM GUARD

Fits ROWSE AG-CO-Gleaner Series 3, 300-8200; Challenger, JD Quik-Tack, 200, 900, 900 R&F, Honey Bee, New Holland 88C, 92C, 94C. Replaces 10616.10, 16500.10.



Order No	List
G81-0201	15.96

### 17MM GUARD

Fits Case IH 820, 1020. Replaces 10618.10, 16502.10.



Order No	List
G81-0202	17.94

**1-YEAR WARRANTY ON ALL ITEMS!**

HERSCHEL sections are made in the USA from high quality boron steel. Heat-treated for long life. Sections are extra heavy (.116") and chrome unless stated otherwise.



### SECTIONS

Fits TRIUMPH MOWERS. Section is 3" x 3-1/4". Uses 9/16 OH rivet. Sold 10 sections per pack.

#### OEM

Number	Application	Design	Order No.	List
646	XH US	A-	S20-5246	11.24
1227	XH SM		S20-1142	13.22
SSBKE45996	XH7TS	A+	S20-3407	11.15
982752	XH7TS CR	A+	S20-4286	12.85



### 6' SICKLES

Fits TRIUMPH MOWERS AND HYDRO-CLIPPER.

Head OEM# 1874.

OEM #	# of Sections	Section OEM	Riveted		Bolted	
			Order No	List	Order No	List
1876	24 - XHUS	M646	S35-3062	159.29		
SS1876BN	24 - XH7TS	SSBKE45996			S35-1077	200.32
BN1876CRSS	24 - XH7TSCR	SSE45996			S35-2924*	169.17

\* Note: Special Order Item. Minimum quantities may be required

### SECTION TYPES

7TS = Super 7® Top Serrated  
 SM = Smooth  
 US = Under Serrated - 14 Tooth  
 TS = Top Serrated - 14 Tooth  
 TT = Tiger Tooth  
 TJ = Tiger Jaw  
 SRK = Tiger Shark™



### SICKLE HEAD

Fits TRIUMPH MOWERS AND HYDRO-CLIPPER. REPLACES 1874.

Order No.	List
H15-0288	72.13

### PITMAN STRAP - FRONT

Fits TRIUMPH MOWERS

Replaces	Order No	List
MA1577	S78-0834	79.20



### PITMAN STRAP - REAR

Fits TRIUMPH MOWERS

Replaces	Order No	List
M1578	S78-0835	83.77



### GUARD BOLT

#3 Plow bolt. 7/16" x 1-1/2".

Qty	Order No	List
50	B55-0260	19.95
10	B55-0260D	9.17



### HOLD DOWN CLIP ADJUSTABLE

Fits most TRIUMPH MOWERS. Steel. Low Arch

Order No.	List
C45-0040	5.65

### GUARD BOLT

#3 Plow bolt. 7/16" x 1-3/4".

Qty	Order No	List
50	B55-0265	22.43
10	B55-0265D	9.17



### BALER IDLER BEARING

Fits VERMEER C, F, G, H, I, J, K, L, XL, Rebel Series. 1-1/2" Spherical w/collar

Replaces Number	Order No	List
212-001	H212001	16.94

### BALER UPPER DRIVE BEARING

Fits VERMEER K, L, XL Series. 1-15/16" Spherical 4 Bolt

Replaces Number	Order No	List
110457-003	H110457003	22.58

### BALE TOOTH

For VERMEER B & C Balers. Replaces F-413/48893001. .187 Wire. 100/Case. Yellow.

Order No.	List
V-1	4.16

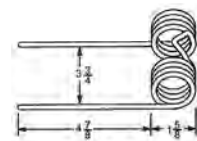

### BALER HAY SAVER BEARING

Fits VERMEER G, H, I, J, K, L, XL, M Rebel Series. 1-1/2" Cylindrical w/collar.

Replaces Number	Order No	List
4051-001	H4051001	7.24

### RUBBER MOUNT RAKE TOOTH

For VERMEER R9, R21, R23, R23A, R24, R24A, R2300. Replaces EF2888001, AE56204. Right/Left hand. 1-5/8" inside saddle width, centered mounting holes. 100/box.

Order No.	List
T16-0185	3.65



### BALE TOOTH

For VERMEER D Series Baler. Replaces F-1326/29-001. .187 Wire. 100/Case. Yellow.

Order No.	List
V-2	4.16

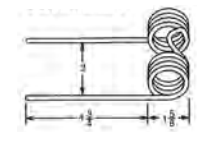

### BALER PICKUP DRIVE BEARING

Fits VERMEER I, J, K, L, XL, M, Rebel Series. 1-1/4" Spherical w/collar.

Replaces Number	Order No	List
4052-001	H4052001	10.20
502289-001		



### RUBBER MOUNT RAKE TOOTH

For VERMEER R2800 Rakes. Replaces 510501250. .276" wire diameter. 3/8" whole diameter. 1-7/8" saddle. 9-1/2" long. 100/box.

Order No.	List
T16-0189	4.19



### BALE TOOTH

For VERMEER Round Balers E, F, G Series. Replaces 4059-001. Spring. 100 per box. .207 wire.

Order No.	List
T16-0485	3.65



### SPRING TOOTH

For VERMEER Super F, G, H, I, J, K, L, XL & Rebel Series. 150, 1450, 504, 505/5410, 5410, 550. Replaces 4000-997, 27997-001. 50 per box. 7"

Order No.	List
T16-0488	5.47



**LOOKING FOR POLY BALER PICKUP BANDS?**  
See Page 114.

### BALER POLY PICKUP BAND

For VERMEER Round Baler I, Super I, J, Super J, K, L, XL, Super M, N, Rancher, Rebel. Replaces 89982001.

Order No.	List
H89982001	35.08



### DISC MOWER KNIVES

Fits VERMEER 230, 275, 320

Length: 3.66"	Degree of Twist: 13	Hole Diameter: .64
Width: 1.60	Thickness: 0.116	Center Of Hole To Back Edge: .80

OEM Number	Style	Shape	Bolt Order No	6 Blades Order No	List	25 Blades Order No	List
DM303	4	LH Twisted	B55-0358D	B45-6996D	10.18	B45-6996	30.57
DM304	4	RH Twisted	B55-0358D	B45-6997D	10.18	B45-6997	35.62



### GATHERING WHEEL

Wheels provide the reliable performance you expect from OEM quality gathering wheel. Bolt holes are pre-punched for ease of installation and offered pattern fits most balers equipped for this wheel style.

### GATHERING WHEELS

Unique blend of rubber compounds offering durability and performance. The tough rubber fingers resist breakage and provide a longer service life.

Model	Description	Order No.	List
504 I, 504 L, 504 SI, 505 I, 504 SI, 554 XL, 555 XL, 604 J, 604 K, 605 J, 605 K, 604 L, 605L, 605 SJ, 604 SJ, 604 XL, 605 XL, 5400 Rebel, 5410 Rebel, 5420 Rebel, 5500 Rebel, 5520 Rebel, 540 M Classic, 664 Rancher, 665 Rancher, 6640 Rancher, 6650 Rancher	24" x 9" Gathering Wheel	W29-0405	139.69
504 F, 504 G, 504 H, 605 F, 605G, 605H	28" x 12" Gathering Wheel	W29-0415	178.50

### RAKE WHEELS

Heavy Duty, .276" (7mm). Overall diameter: 55"

Description	Order No.	List
Right Hand. P20BG003	W16-0805	111.98
Left Hand. P20BG004	W16-0806	111.98
Replacement Tine: T16-0497.		

Heavy Duty, .276" (7mm). Painted Creme Overall diameter: 55"

Description	Order No.	List
Right Hand. P20BG003	W16-0811	111.98
Left Hand. P20BG004	W16-0812	111.98
Replacement Tine: T16-0497.		

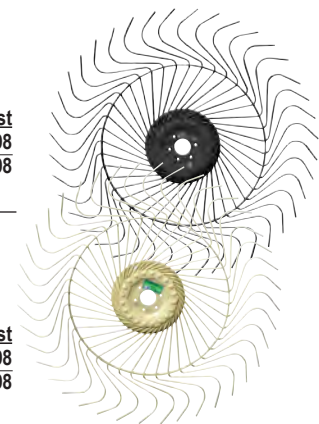

### ROUND BALER BELTS

- Nylon fabric reinforcement in the outer ply to help the belt stretch under heavy loads.
- Polyester center ply helps lace retention and stabilize belt
- Belt & lacing meet or exceed OEM specifications
- 3-Ply belt offers increased durability saving downtime.

Fits 504 I (older model), 504-IS(silage), 505 Super I, 504 Super I, 5400 Rebel, 504L, 505-I (older model)

Description	Order No.	List
6" x 424" 3-Ply LMP Top With Clipper Lace	VER6X424IMC	294.98



**BOLTED SICKLES - HEADLESS XH7TSCR SECTIONS**

Fits WHITE 6400 WINDROWER WITH DRAPER HEADER



Section part number is S20-4398, OEM# SS34390CR.

OEM #	Length	#of Sections	Order No	List
33704	18'	71	S35-2262	354.08
43074, 338616A1	21'	83	S35-2253	351.47
43076, use w/ S35-2253	4' EXT	16	S35-2254	182.37
43077, use w/ S35-2253	9' EXT	36	S35-2255	263.55

**BOLTED SICKLES - HEADLESS XHTSCR SECTIONS**

Fits WHITE COMBINES WITH KWIK CUT SYSTEM

Size	Description	Order No	List
13' & 15'	Universal 2-point Tiger Jaw sickle	S35-2154	349.04
18' & 20'	Universal 2-point Tiger Jaw sickle	S35-2156	423.03
4'	4' Extension, use with S35-2156	S35-2271	82.03



**COMBINE PICKUP REEL**  
For WHITE Hume reels. Replaces 1127024. Steel. 100 per box.

Order No.            List             
T16-0124            1.60



**NYLON FLEX TINE**  
Replaces N66A. 1 mounts to front of bat. 100 per box.

Order No.            List             
T16-0183            189.12



**NYLON FLEX TINE**  
Replaces N67A. 1 mounts to rear of bat. 100 per box.

Order No.            List             
T16-0767            165.82



**2 PIECE M/L REEL TINE**  
Replaces 782551, 1989438C1, AH136689, AH153175. 100 per box.

Order No.            List             
T16-0720            175.64



**2 PIECE M/L REEL TINE**  
Replaces 782226, 1989438C1, AH136689, AH153175. 10 per bag.

Order No.            List             
T16-0715            19.03



**M/L REEL TINE**  
For T16-0715 and T16-0720. No clamps. Replaces HA100MLT. 100 per box.

Order No.            List             
T16-0725            128.83

**REPLACEMENT SCREW**

For T16-0715 and T16-0720. No clamps. Replaces HA20SC. 20 per box.

Order No.            List             
B55-0096D            2.40

**RAKE TOOTH**

Fits No. 5 Rake. Replaces 64562. Mfr: Minnesota.



Order No.            List             
T16-0370            2.20

**SICKLE HEAD**

Drive adapter bar for Kwik Cut.

Order No.            List             
H15-0219            24.82

**PLASTIC BEARING KIT**

Includes 6 caps, 6 bases, U-Bolts and 12 nuts.



Application: Reels with Wood Bats used on Case-New Holland 810, 820.

Order No.            List             
B15-0915            27.47

**FORGED STEEL GUARD**

Fits WHITE COMBINES WITH FLOATING BARS W/GROOVE. Replaces 31-2749417, FC89-2 and HA231, BU231.



Order No.            List             
G81-0125            16.78

**FORGED STEEL GUARD**

Fits WHITE WINDROWERS 501, 502, 503. Replaces 895744L, FS73-2, HA235.



Order No.            List             
G81-0070            13.96

**FORGED STEEL GUARD**

Fits WHITE COMBINES WITH RIGID BARS. Replaces 9510220, HA240, BU240.



Order No.            List             
G81-0191            8.79

## SECTION BOLTS

- Quick and easy section changes are possible with bolts.
- No more cutting, chiseling, or grinding - simply unbolt the section, replace and tighten bolts.
- Bolts will not turn in Knife Back and are reusable. They will last thru the life of several sections.
- Bolts may be replaced easily if accidentally damaged or broken.
- No special tools are needed to change sections, only a 7/16 wrench or socket.
- Bolt and nuts hold better than rivets and they have a greater clamp load than rivets.
- Special lock nuts will not vibrate loose.

Description	Application	Pkg.	Qty. Mst Ctn.	Order No	List
Section Bolt w/nut	Universal - Replaces 9/16 & 5/8 OH Rivets	50	300	B55-0065D	9.55
Head Bolt w/nut	Universal - Replaces 1-1/2 & 1-1/16 OH Rivets. 1" long.	15	90	B55-0085D	5.85
Head Bolt w/nut	Universal - Replaces 1-1/2 OH Rivets. 1-21/64" long.	12	72	B55-0095D	6.02
Section Bolt w/nut	Case I-H Combines 1010 & 1020, 1-1/2 System**. Oval Head.	20	120	B55-0050D	18.56
Head Bolt w/nut	Case I-H Combines 1010 & 1020, 1-1/2 System**. Oval Head.	16	96	B55-0060D	25.89
Section Bolt w/nut	Universal Bolts for 10' Sickle w/Head Bolts (80-B55-0065D, 5-B55-0085D, 5-B55-0095)	90	Each	B55-0500D	22.76
Overlap Bolt w/Low Profile Nut*	Double Drive Sickles, replaces 1/2 CS rivets 60° Head	10	60	B55-0059D	7.06
Section Bolt*	Versatile, Countersink, replaces 9/16 CS rivets	20	120	B55-0056D	10.82
Section Bolt*	Love & Hart Carter, Countersink, replaces 5/8 CS rivets, 60° Head	20	120	B55-0057D	5.05
Head Bolt*	Love, Hart Carter & Versatile, Countersink, replaces 1 CS rivets	10	6	B55-0058D	8.56
5/8" Section Bolt w/nuts 90° CSK, Oval Shoulder	Versatile, Windrower 4400, 2400, 2800	20	120	B55-0955D	8.03
7/8" Head Bolt w/nuts; 90° CSK, Oval Shoulder	Versatile, Windrower 4400, 2400, 2800	10	60	B55-0975D	3.84
1" Ribbed Bolts & Nuts; 60° CSK	Versatile	25	150	B55-0971D	10.34
Nut	Universal-Used on all the above bolts except B55-0050D	20	120	N83-0289D	5.36
Low Profile Nut	Overlap Area on Dbl. Drives & Case/IH 1020 1-1/2" Systems	20	120	N83-0295D	5.45

\* Use with Allen Wrench \*\* Requires IH Hold Down OEM#132074663



## BALER SHEAR BOLTS

Designed to meet OEM specifications. All bolts are grade 5, plain finish except where noted. Pkg. of 10 bolts with nuts.

Description	Order No.	List
John Deere 1/4"-20 x 2-1/4" Hex Head.	B55-0550D	12.91

New Holland 5/16-18 x 2" Hex Head.	B55-0551D	14.33
---------------------------------------	-----------	-------

## GRASS BOARD

Fits all mowers.



Order No	List
B52-0615	44.40

## SECTION RIVETS - ZINC PLATED

OH = Oval Head CS = Counter Sunk

Size/No. in Pkg.	Application	Qty. Pkg.	Mstr. Ctn.	Order No	List
5/8" # 5-1/2 (56)	7" Heavy Mower Sections and Knife Heads	Asst.	6	R36-0523D	7.75
1" # 5-1/2 (10)	Mower Conditioners	Asst.	6	R36-0524D	9.39
5/8" # 5-1/2 (72)					
1" # 5-1/2 (5)					
1-1/4" # 5-1/2 (5)					
5/8" OH #5-1/2	Heavy Gauge Sections	1#	6#	R36-0462D	13.40
15/16" OH #5-1/2	Head Rivet	1/2#	3#	R36-0522D	6.32
1-1/4" OH #5-1/2	Head Rivet	1/2#	3#	R36-0467D	6.83
5/8" CS #5-1/2	Section Rivet	1#	6#	R36-0463D	10.94
1-1/4" CS #5-1/2	Guard Plate Rivet	1/2#	3#	R36-0468D	6.63
9/16" (1 lb./BB)	CS Rivets Zinc Plt. Primarily used on Rice Cutterbars	1#	6#	R36-0469D	11.29



## BOLT-N-CLIP KIT

**Why bolts are better than rivets:**

- Bolts will not turn in Knife Back and are reusable.
- They will last thru the life of several sections.
- Bolts may be replaced easily if accidentally damaged or broken.
- No special tools are needed to change sections, only a 7/16 wrench or socket.
- Bolts and nuts hold better than rivets. They have a greater clamp load than rivets.

Fits most mowers, mower conditioners and combines. For 10' bar. Includes 9 Low Arch Clips, 1 High Arch Clip, Bolts & Nuts to do a 10' Bar

Order No	List
B55-0629	40.16



## BALE COUNTER

Bale counter, reads up to 99,999. 4-hole mounting plate, push button reset, adjustable side arm. Fits most balers.



Order No.            List  
T55-0002            25.30

## PITMAN WOOD - UNIVERSAL



Order No.            List  
P38-0560            24.25



## HAMMER RIVET TOOL

For Drive Rivets

Order No.            List  
T55-0812            30.72

## HAMMER RIVETS - LARGE HEAD

The R36-0653 Hammer rivet is designed for use of the John Deere 900 series heads with predrilled holes, and can be used in place of the B55-0004 Torque Bolts.



Size	Application	Qty.	Order No.	List
1/4" x 5/16"	JD 900Series-End Plate P44-1126 & Wobble box Plate P44-1127	20/BB	R36-0654	5.92

## UNIVERSAL END SECTIONS

HERSCHEL "End Sections" are made of one-piece high carbon, heat-treated steel for rugged use. They are punched with an oblong hole to virtually fit any standard cutterbar mower in use today. To install our "End Section", simply take off the last section on the shoe end of your sickle assembly and replace it with an "End Section". The change-over takes only a couple of minutes to complete and you will notice a big difference in time saved from unclogging your mower. We recommend using a R36-0523D oval head rivets or B55-0065D Bolts.

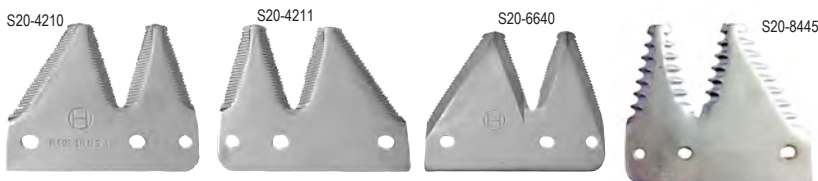

Replaces	Description	Order No	List
3TS-7	XHTTSCR (RH) 10/Box	S20-4403	38.49
3TS-7-SP	XH7TSCR (RH) 2/SP	S20-4403D	10.54
3TS-7	Tiger Shark™ (RH) 10/Box	S20-8403	45.13
3TS-7-SP	Tiger Shark™ (RH) 2/SP	S20-8403D	12.06
3TS-7-LH	XH7TSCR (LH) 10/Box	S20-4445	41.22
3TS-7-LH-SP	XHTTSCR (LH) 2/SP	S20-4445D	13.94
3TS-7-LH	Tiger Shark™ (LH) 10/Box	S20-8445	45.13
3TS-7-LH-SP	Tiger Shark™ (LH) 2/SP	S20-8445D	12.06

Replaces	Description	Order No	List
3TS	XHTSCR (RH) 10/Box	S20-4210	38.49
3TS-SP	XHTSCR (RH) 2/SP	S20-4210D	10.54
3TSLH	XHTSCR (LH) 10/Box	S20-4211	38.49
3TSLH-SP	XHTSCR (LH) 2/SP	S20-4211D	10.54
2US	XHUSCR (RH) 10/Box	S20-6640	40.77
2US	XHUSCR (RH) 2/SP	S20-6640D	10.54

## WHY TRY TIGER SHARK™ SECTIONS?

1. Serrated teeth allow more cutting surface.
2. They last longer, cut faster.
3. Cuts equally well in soybeans, alfalfa, grass hay, wheat, etc.



### Customer Testimonial:

"I cut over 1000 acres of soybeans with the same *Herschel Tiger Shark™* sections. They stayed sharper longer and lasted longer than any section I have used."

- Roger Woodruff, Warren Co. Iowa



## STRAW CHOPPER SECTION - XHUS

For Most Barn Straw Choppers. Section is 2-1/16" center to center. 1/4" holes. 10/box

Order No.            List  
S20-5169            12.61



## TUB GRINDER SECTION

For Rotomix Grinders. Hardfaced. Section is 2-1/16" center to center. 5/16" holes. 10/box.

Order No.            List  
S20-1275            52.07

## WEAR PLATES



For Mowers, Swathers, Combines. Replaces W50. 5-7/8" long. Slotted holes with 3" spacing.

Order No.            List  
P44-0591            2.95  
P44-0591D\*            10.27

\*Display Pack of 2.



24" length with 1-1/2" spacing. Heat treated.

Order No.            List  
P44-0200            15.14

## UNIVERSAL BOLTED SICKLES - HEADLESS

S35-1038/1039/1040



Fits IH Mowers & 990, 1190 M/C; Ford 505, 535, 536, 537 Mowers & 538 M/C; Gehl 880, 1090, 2130, 2160 M/C; Hesston all single drive M/C and Windrowers; New Holland 450, 451, 455, 456 Mowers & 460, 461, 467, 469, 1469, 472, 477, 478, 479, 488, 489, 490, 492, 1469 M/C; New Idea 10, 20, 30, 40, 41, 521, 522 Mowers & 290 M/C; Owatonna 180, 196, 197, 200, 206, 207, 208, 216, 217, 2140, 2170 M/C.

Size	Hole Spacing	Section Type	No. Of Sections	Order No	List
7'	2-1/16"	XH7TS	30	S35-1038	94.93
9'	2-1/16"	XH7TS	38	S35-1039	111.45
9'	2-1/16"	TIGER SHARK™	38	S35-2639	128.05
2'	2-1/16"	XH7TS	9	S35-1040	45.70

Use C83-0755 Splice Kit

Fits AC 7, 80; John Deere 5, 8, 9, 11, 37, 38, 39, 47, 50, 250, 350, 450, 3700 Mowers, 480, 483, 485, 1207, 1209, 1217, 1219 M/C; Ford 50, 51, 62, 63, 64, 65, 66, 175, 176, 234, 257, 258, 259, 260, 501, 502, 515, 14-3, 14-4, 14-15, 14-16, 14-94, 95, 96, 97, 14-280, 1, 2, 3

Size	Hole Spacing	Section Type	No. Of Sections	Order No	List
7'	2"	XHUS	30	S35-1035	130.31
9'	2"	XHUS	38	S35-1036	150.66

Use C83-0750 Splice Kit

## HOLD DOWN CLIPS

### NON-ADJUSTABLE

No matter what type of cutting condition you might encounter, we have a universal knife clip for you. The clips listed below are designed to adapt to virtually any standard cutter bar on mowers, swathers, windrowers, and even combines.



Fits Bolted sickles with head clearance. Steel.

Style	Order No.	List
Low Arch	C45-0692	3.57
Low Arch	C45-0692D*	9.11
High Arch	C45-0693	4.79
High Arch	C45-0693D*	7.26

\*Pack of 2

## HOLD DOWN CLIPS

### ADJUSTABLE



Fits Most Hay Machines and Combines. Cast.

Style	Order No.	List
Low Arch	C45-0006	21.39
High Arch	C45-0007	21.39



Fits most Combines, Mowers & Windrowers, except Versatile, Hart-Carter & Love. Steel.

Style	Order No.	List
Low Arch	C45-0040	5.65
Low Arch	C45-0040X*	169.64

\*Box of 24 clips.

## BALE SPEARS

Assembling Advice For Square Tines



- High Tensile Strength Heat Treated Steel
- Standard Duty 2500# 1-3/4" Diameter
- Heavy Duty 3500# 1-3/4" Diameter
- Threaded Spears Include Nut

## BOLT ON SPEARS

Nut Included. Order Sleeve Separately.

Description	Length	Capacity	Order No	List
Threaded 36mm diameter	32"	1800 lbs	BS32ONEWN	37.31
Threaded 45mm diameter	32"	2500 lbs	BS32WN	53.32
Threaded 36mm diameter	39"	1800 lbs	BS39ONEWN	59.80
Threaded 45mm diameter	39"	2500 lbs	BS39WN	55.40
Threaded 45mm diameter	43"	2500 lbs	BS43WN	61.26
Threaded 45mm diameter	49"	2500 lbs	BS49WN	73.41
Threaded 45mm diameter	32"	3500 lbs	BS32WNHD	62.10
Threaded 45mm diameter	43"	3500 lbs	BS43WNHD	81.13
Threaded Heavy Duty	49"	3500 lbs	BS49WNHD	92.81

## PIN ON SPEARS

Order Bushing/Sleeve Separately.

Description	Length	Capacity	Order No	List
Cross Bolt Standard Duty	43"	2500 lbs	BS43CB	63.38
Cross Bolt Standard Duty	49"	2500 lbs	BS49CB	76.45

## HARDWARE

Description	Order No	List
Nut. 1.18" diameter	BSNUT	3.10
Sleeve Standard Duty. 4.72" long	BSSLEEVE	12.59
Sleeve Heavy Duty. 5.71" long	BSSLEEVEHD	15.03
Sleeve For Pin On w/1/2" hole. 5.71" long	BSSLEEVECB	13.43
Sleeve For 36mm diameter spears. 4.33" long	BSONESLEEVE	12.07

**1-YEAR WARRANTY ON ALL ITEMS!**

## TEDDER TIRES

Ribbed tire and rim assembly. Includes bearings.

6 Ply. 1" Bore. 3.18" Hub Length

Fits Krone, Kuhn, John Deere, New Holland, M&W, Sitrex

Size	Order No.	List
15" x 600-6"	W29-1506	70.94
16" x 6.50-8"	W29-1608	97.09



W29-1608

4 Ply. 1" Bore. 2.28" Hub Length

Fits Galfre, Kuhn, John Deere, New Holland, Rossi, Sitrex, Tonutti, Vermeer

Size	Order No.	List
3.50" x 6"	W29-0306	60.82



**RAKE WHEELS**

Heavy Duty, .275. Fits Sitrex, Case, H&S, M&W, New Holland, Westward, AGCO, Atlas, Befco, Bush Hog, Hesston, Kelderman, MF, New Idea, Ogden, Otma, Panorama, Rhino and Ross.  
Painted Creme  
Overall diameter: 55"

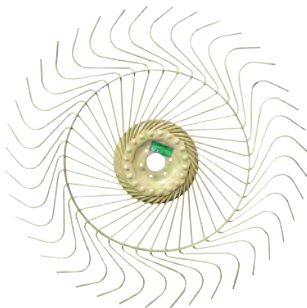

Heavy Duty, .276" (7mm). Fits Tonutti/National/Walton, John Deere/Frontier, Vermeer, Kuhn, Miller Pro/Arts Way, Gehl, Pequea.  
Painted Black  
Overall diameter: 55"

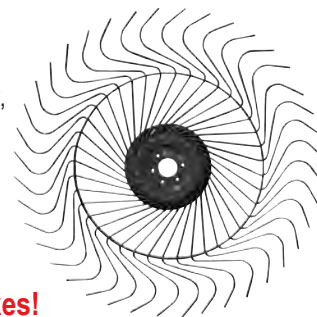

**Fits Kuhn Speed Rakes!**

Description	Order No.	List
Right Hand	W16-0801	111.98
Left Hand	W16-0802	111.98

Replacement Tine Part Number T16-0815.

Description	Order No.	List
Right Hand. P20BG003	W16-0805	111.98
Left Hand. P20BG004	W16-0806	111.98

Replacement Tine: T16-0497.

Heavy Duty, .275. Fits Sitrex, Case, H&S, M&W, New Holland, Westward & Others.  
Painted Black  
Overall diameter: 55"

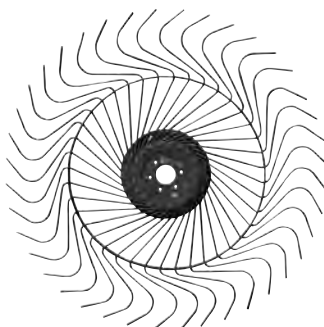

Description	Order No.	List
Right Hand	W16-0809	111.98
Left Hand	W16-0810	111.98

Replacement Tine Part Number T16-0815.

Heavy Duty, .276" (7mm). Fits Tonutti/National/Walton, John Deere/Frontier, Vermeer, Kuhn, Miller Pro/Arts Way, Gehl.  
Painted Creme  
Overall diameter: 55"

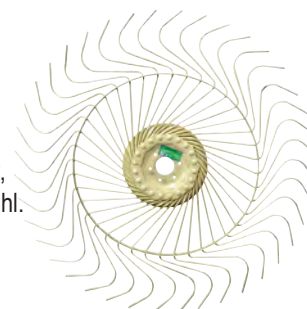

Description	Order No.	List
Right Hand. P20BG003	W16-0811	111.98
Left Hand. P20BG004	W16-0812	111.98

Replacement Tine: T16-0497.

**HIGH CAPACITY RAKE WHEEL**

.295". Fits Sitrex, H&S, New Holland & Others.  
Painted Black  
Overall diameter: 60". Black.

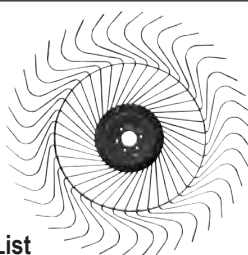

Description	Order No.	List
Right Hand	W16-0808	122.27
Left Hand	W16-0807	122.27

Replacement Tine Part Number T16-0495.

**HUB ASSEMBLY**

With bearing for all wheels listed at left. Pilot: 3.21". Bolt circle: 5.12". 13mm bolt required

Order No.	List
H16-1000	42.58



**TINE BOLT AND NUT**

Fits Sitrex, Case, H&S, M&W, New Holland, Westward & All Others. 10 Per Blister Pack

Order No.	List
B55-0800D	12.56



**HERSCHEL POLY INSERTS**

- Easy Installation - Pre-Drilled Holes
- Attaches To Rake Wheel With Heavy Duty Ties (Included)
- Increase Efficiency
- Prevents Wrapping
- Block Wind
- Inexpensive Add-On To Your Hay Rake



Application	OD	Center Hole	Order No	List
Sitrex, AGCO, CIH, H&S, Hesston, Kelderman, MF, M&W, NH, New Idea, Ogden & Rhino	55"	31-3/8"	W16-55S	37.98
Tonutti, Gehl, Bush Hog, John Deere, Kuhn, Vermeer & Vicon	55	34-1/2"	W16-55T	43.92
Sitrex	60"	31-3/8"	W16-60S	53.33



**RAKE WHEEL SPRING**

Fits H&S and other Wheel Rakes using lift springs on wheels. 1 used per hay turning wheel. 11" long. 1-7/8" OD. 1-1/2" ID .238 Diameter wire

Order No.	List
S16-1000	13.08

**HA200A (G81-0231)**



OEM	OEM PN#	Buchanan PN	Order No.	List
Case IH	700707147	BU200A	G81-0231	15.27
Hesston	700716292	BU200A		

Fits **Case-IH** Mower Conditioners – 8320, 8330, 8340, 8350, 8360, 8370, 8380, SC412, SC414, SC416. Windrowers – 8210, 8220, 8230, 8240, 8830, 8840. **Hesston** Mower Conditioners – 1110, 1120, 1130, 1150, 1160, 1170,

Weight: 1.69 lb (766.57 g)

**HA206 (G81-0140)**



OEM	OEM PN#	Buchanan PN	Order No.	List
Ford	110-32342	BU-206	G81-0140	19.14
Gehl	110-32342	BU-206		
	110-10327	BU-206		
Owatonna	110-32327	BU-206		

Fits **Ford** Windrower – Series - 537. **Ford-NH** Mower Conditioners – Series - 536. **Gehl** Mower Conditioners – 2140, 2170, 2175, 2240, 2245, 2270, 2275; Windrowers – Series – All After 1979. **Owatonna** Mower Conditioners – Series – All After 1979.

Weight: 1.77 lb (802.86 g)

**HA208DH (G81-0199)**



OEM	OEM PN#	Buchanan PN	Order No.	List
CAT	676295N	N/A	G81-0199	14.86

Fits **Claas-Cat Challenger** Combines.

**HA209 (G81-0200)**



OEM	OEM PN#	Buchanan PN	Order No.	List
CAT/Lexion	767265-1	N/A	G81-0200	17.22

Fits **Lexion** Combines - All

Weight: 1.72 lb (780.18 g)

**HA210 (G81-0183)**



OEM	OEM PN#	Buchanan PN	Order No.	List
Case IH	483500R3	BU-210	G81-0183	10.70
Ford	BU210	BU-210		
IH		BU-210		
New Idea	H483500R3	FS 85-2		
Rowse	670600			

Fits **Case IH** Mowers – Series – 200, 230, 1000, 1100, 1200, 1300, 3110; Forage Harvesters – Series – 650, 655; Mower Conditioners – Series – 170, 175, 200, 225, 816, 990. **Ford** Mower Conditioner – 538. **International Harvester** Combines – 820, 1010, 1020. **New Idea** Mowers – 521, 522. **Rowse** mowers using IH guards.

Weight: 1.78 lb (807.39 g)

**HA215DM (G81-0097)**



OEM	OEM PN#	Buchanan PN	Order No.	List
Case-IH	87560324,	NA	G81-0097	11.50
	87421451		G81-0097G*	17.57
MacDon	23064, 28013,	NA		
	118344, 118484			

Fits **Case-IH** 1042, 1052, 2042, 2052, 2062, 2142, 2152, 2162. **MacDon** 960, 962, 963, 972, 973, 974, D50, D60, FD70, FD75. **New Holland** 84C, 86C. Double heat treat.

Weight: 1.70 lb (771.11 g)

**DRIVE HEAD GUARD** For models above: G81-0094 **13.34**

**LEFT END GUARD** For models above: G81-0092 **13.34**

**RIGHT END GUARD** For models above: G81-0096 **13.34**

\*German Made

**HA215DHC (G81-0093)**



OEM	OEM PN#	Buchanan PN	Order No.	List
Badger Northland	683994M1	BU-215A	G81-0093	18.75
Case IH	700707147	BU-215A		
	88615982	BU-215A		
Hesston	700707147	BU-215A		
	700716292	BU-215A		
Massey Ferguson	683476M1	BU-215A		
	683994M1	BU-215A		
New Holland	219191	BU-215A		
	858778	BU-215A		
	86521587	BU-215A		
	86553340	BU-215A		
	86615892	BU-215A		

Fits **Badger Northland** Mower Conditioners – All 1978. **Case IH** Mower Conditioners – 8230, 8330, 8340, 8350, 8360, 8370, 8380, SC412, SC414, SC416. Windrowers – 8210, 8220, 8230, 8820, 8830, SCX100. Auger – 8840. Draper Header – 1042. **Hesston** Mower Conditioners – 1110, 1120, 1130, 1150, 1170, 1260, 1270, 1275. Headers – 8010, 8020, 8100, 8200, 8400. 2010, 2020 Headers prior to S/N CBJ02000. **Massey Ferguson** Mower Conditioners – Series - 665, 675, 775. **New Holland** Headers – 971, 973, 71C, 73C, 74C. Windrowers – All Mower Conditioners and Windrowers

Weight: 1.70 lb (771.11 g)

**HA215 (G81-0155) & HA215DH (G81-0098)**



OEM	OEM PN#	Buchanan PN	Order No.	List
Badger Northland	683994M1	BU-215A	G81-0155	9.37
Case IH	700707147	BU-215A	G81-0098*	11.23
	88615982	BU-215A		
Hesston	700707147	BU-215A		
	700716292	BU-215A		
Massey Ferguson	683476M1	BU-215A		
	683994M1	BU-215A		
New Holland	219191	BU-215A		
	858778	BU-215A		
	86521587	BU-215A		
	86553340	BU-215A		
	86615892	BU-215A		

Fits **Badger Northland** Mower Conditioners – All 1978. **Case IH** Mower Conditioners – 8230, 8330, 8340, 8350, 8360, 8370, 8380, SC412, SC414, SC416. Windrowers – 8210, 8220, 8230, 8820, 8830, HDX121, HDX122, HDX141, HDX142, HDX161, HDX162, HDX181, HDX182, SCX100, SMX9. Auger – 8840. Draper Header – 1042. **Hesston** Mower Conditioners – 1110, 1120, 1130, 1150, 1170, 1260, 1270, 1275. Headers – 8010, 8020, 8100, 8200, 8400. 2010, 2020 Headers prior to S/N CBJ02000. **Massey Ferguson** Mower Conditioners – Series - 665, 675, 775. **New Holland** Headers – 971, 973, 71C, 73C, 74C. Windrowers – All Mower Conditioners and Windrowers

\*Double Heat Treated. Can be used in place of G81-0155.

Weight: 1.70 lb (771.11 g)

**HA218 (G81-0184)**



OEM	OEM PN#	Buchanan PN	Order No.	List
New Holland	219190	BU-218	G81-0184	9.37

Fits **New Holland** Mowers – All

Weight: 1.70 lb (771.11 g)

**HA218DH (G81-0144)**



OEM	OEM PN#	Buchanan PN	Order No.	List
New Holland	219190	BU-218H	G81-0144	10.65

Fits **New Holland** Mowers – All

Double Heat Treated

Weight: 1.72 lb (780.18 g)

**HA220 (G81-0185)**



OEM	OEM PN#	Buchanan PN	Order No.	List
Gehl	072057	BU-220	G81-0185	14.12
John Deere	E48093	BU-220		
	E52667	BU-220		
	E82559	BU-220		

Fits **Gehl** Mower Conditioners – 770, 880, 1070, 1090. **John Deere** Mowers – 37, 38, 39, 250, 350, 450. Mower Conditioners – 480, 483, 485. Windrowers – 215, 215A, 780, 800, 880. Platform Augers – 18, 19, 183, 188, 220 & 230 prior to s/n 425000. Draper Platforms – 78, 88, 120, 130, 135

Weight: 1.61 lb (730.28 g)

**HA221 (G81-0186)**



OEM	OEM PN#	Buchanan PN	Order No.	List
John Deere	E52667	BU-221	G81-0186	15.24
John Deere	E62000	BU-221		

Fits **John Deere** Mower Conditioners – 1207, 1209, 1214; 1217, 1219 prior to s/n 710000; 1380, 1424. Platform Augers – 230 s/n 425001 and up; 240

Weight: 1.79 lb (811.93 g)

**HA222DH (G81-0147)**



OEM	OEM PN#	Buchanan PN	Order No.	List
John Deere	E72428	BU-222H	G81-0147	12.02

Fits **John Deere** Mower Conditioners and Windrowers with Platforms – 300, 300A prior to s/n 943000; Mower Conditioners – 1217, 1218 s/n 71001 & later; 1600.

Weight: 1.79 lb (811.93 g)

**HA225 (G81-0187)**



OEM	OEM PN#	Buchanan PN	Order No.	List
Allis-Chalmers	1116504	BC-225	G81-0187	14.12
Deutz-Allis	1116504	FC-225		
Gleaner	1116504	BC-225		

Fits All **Allis-Chalmers** GLEANER Combines – 1955 and later. All **Deutz-Allis** GLEANER Combines. GLEANER Headers

Weight: 1.06 lb (480.81 g)

**HA231 (G81-0125)**



OEM	OEM PN#	Buchanan PN	Order No.	List
Allis-Chalmers	1176532	BU-231	G81-0125	16.78
Hart-Carter	232155	BU-231		
	234006	BU-231		
	234239	BU-231		
	273846	BU-231		
International Harvester	179755C1	BU-231		
Deutz-Allis	1320143	BU-231		
Massey Ferguson	71320143	BU-231		
	1053174M1	BU-231		
White Farm	31-2749417	BU-231		

Fits **Allis-Chalmers** Combines – All Floating Head. **Deutz-Allis** GLEANER Combines – All Floating Head. **Hart-Carter** – All Floating Cutterbars. **International Harvester** – Combines – 810 Flex Head. **Massey Ferguson** Combines – Floating Platforms (except 9110 Flex). **White Farm** – Combines – All Floating Head.

Weight: 1.43 lb (648.64 g)

**HA235 (G81-0070)**



OEM	OEM PN#	Buchanan PN	Order No.	List
Cockshutt	895744L	BU-235	G81-0070	13.96
International Harvester	K8420S	BU-235		
Kilberry	K8420S	BU-235		
MacDon	K16716-1	BU-235		
	K8420S	BU-235		
Massey Ferguson	1041468M1	BU-235		
Oliver-White Farm	895744L	BU-235		

Fits **Cockshutt** Windrowers – All. **International Harvester** Windrower – 75. **Kilberry** Windrower. **MacDon** Windrowers – 1000 Series. **Massey Ferguson** Windrowers – 35, 665, 675, 775, 785. **Oliver White Farm** Windrowers – 501, 503.

Weight: 1.64 lb (743.89 g)

**HA240 (G81-0191)**



OEM	OEM PN#	Buchanan PN	Order No.	List
John Deere	H61954	BC-240-A	G81-0191	8.79
	H75386	BC-240-A		
	H145791	BC-240-A		
Massey Ferguson	228392M1	BC-240-A		
	228392M2	BC-240-A		
New Holland	134024	BC-240-A		
New Idea	714611	BC-240-A		
White	9510220	BC-240-A		

Fits John Deere Combine – 2-Prong, All Models. **Massey Ferguson** Combines – 2-Prong, All Models. **New Holland** Combines – Rigid Bar. **New Idea** Combines – Uni-Harvest, 71, 711, 715. **White**. Weight: 1.14 lb (517.01 g)

**HA240S (G81-0021)**



OEM	OEM PN#	Buchanan PN	Order No.	List
John Deere	H145791	BC-240-S	G81-0021	14.17

Fits **John Deere** Combines – All John Deere Platforms. **Massey Ferguson** Combines – All Rigid Bar Platforms. **New Holland** Combines – All New Holland Rigid Bar Platforms. **New Idea** Combines – 711, 713, 715. **White Farm** Combines – Fixed Cutter Bars

Weight: 1.14 lb (517.01 g)

**HA245 (G81-0192)**



OEM	OEM PN#	Buchanan PN	Order No.	List
Case IH	700700845	BU-245	G81-0192	9.38
Gehl	611179	BU-245		
	611902	BU-245		
Hesston	49239	BU-245		
	700700845	BU-245		
	748178	BU-245		
New Holland	65327	BU-245		
New Idea	BU245	BU-245		
Versatile	V94711	BU-245		
	65327	BU-245		

Fits **Case IH** Mower Conditioners – 8320, 8330, 8340, 8350, 8360, 8370, 8830. Windrowers – 8210, 8220, 8230, 8240, 8820, 8830. Auger Header – 8840. **Field Queen**. **Gehl** Mower Conditioners – 2130, 2160. Windrowers – 2230, 2262. **Hesston** Mower Conditioners – 1010, 1071, 1085, 1090, 1091, 1110, 1120, 1150, 1160. Windrowers – 310, 420, 500, 600, 620, 6200, 6400, 6610, PT10, PT12, PT7, 1014+2. Headers – 6450, 6465, 6566, 6665, 8050, 8100, 8200, 8400. **New Holland** – 970, 972. **New Idea** Combines – 815 through 820. **Versatile** – 4812, 4814

Weight: 1.72 lb (780.18 g)

**HA245DH (G81-0042)**



OEM	OEM PN#	Buchanan PN	Order No.	List
Hesston	700700845	BU-245H	G81-0042	13.92
	700707147	BU-245H		
	700716292	BU-245H		

Fits **Hesston** Mower Conditioner – All Models

Weight: 1.72 lb (780.18 g)

**HA246 (G81-0246)**



OEM	OEM PN#	Buchanan PN	Order No.	List
Hesston	66603		G81-0246	12.63

Fits **Hesston** Mower Conditioner – All Models

Weight: 1.71 lb (775.64 g)

## HA250 (G81-0120)



OEM	OEM PN#	Buchanan PN	Order No.	List
Badger Northland	699020M1	BU-250	G81-0120	13.18
Gehl	049312	BU-250		
	060494	BU-250		
Hesston	049320	BU-250		
International Harvester	472717R1	BU-250		
J.I. Case	049312	BU-250		
John Deere	E71880	BU-250		
Massey Ferguson	669020M1	BU-250		
New Holland	257635	BU-250		
	86617061	BU-250		

Fits **Badger Northland** Mowers – 1978 and Later. **Gehl** Mower Conditioners. **Hesston** Mower Conditioners. **J.I. Case** Windrowers. **John Deere** Mowers. **International Harvester** Forage Harvesters. **Massey Ferguson** Windrowers. **New Holland** Mower Conditioners

All Stub Guard Applications

Weight: 1.15 lb (521.63 g)

## HA254DH (G81-0102)



OEM	OEM PN#	Buchanan PN	Order No.	List
Hesston	700702736	BU-254-H	G81-0102	15.86
John Deere	E59625	BU-254-H		

Fits **John Deere** Mower Conditioner – 1974 - 1978 All. Mowers 1973-2001 – All Sickle Bar. Combines – Series 200, 1976 - 1990

Weight: .96 lb (435.45 g)

## HA260 (G81-0085)



OEM	OEM PN#	Buchanan PN	Order No.	List
Field Queen	049270	BT-260	G81-0085	14.40
Gehl	049270	BT-260		
Hesston	049270	BT-260		
International Harvester	823025C1	BT-260		
J.I. Case	049270	BT-260		
New Holland		BT-260		

Fits **Field Queen** Windrowers – 420, 620. **Gehl** Windrowers. **Hesston** Mower Conditioners – All Models, Tie Guards. **International Harvester** Windrowers – All, except – 75. **J.I. Case** Windrowers – Same as FQ245 using Tie Guards. **New Holland** Windrowers.

Weight: 1.39 lb (630.49 g)

## HA265 (G81-0055)



OEM	OEM PN#	Buchanan PN	Order No.	List
Case IH	633098R1	BC-265	G81-0055	18.48

Fits **Case IH** Combine – 810, 815, 915 Headers

Weight: 1.38 lb (625.96 g)



**HA270 (G81-0035)**



OEM	OEM PN#	Buchanan PN	Order No.	List
Case IH	613838R2	BU-270	G81-0035	13.05
Field Queen	788278	BU-270		
Gehl	044779	BU-270		
International Harvester	613838R2	BU-270		
Kosch	K101	BU-270		
New Idea	H613838R2	BU-270		

Fits **Case IH** Mowers – 100, 110, 115, 120. Mower Conditioners – 1190, 1290, 1490, 1590. Windrowers – 75, 210, 230, 275, 375, 4000, 5000, 5500. Platforms – All 820 Platforms – Fit 110 and 1020 Platforms with Guards equipped with Cross Bar. **Field Queen** Hay Harvesters – All. **Gehl** Mower Conditioners – MA206A, HK108, HK440. **International Harvester** Windrowers – 175, 200. Mowers – All. **Kosch** Mowers – All

Weight: 2.02 lb (916.26 g)

**HA275 (G81-0196)**

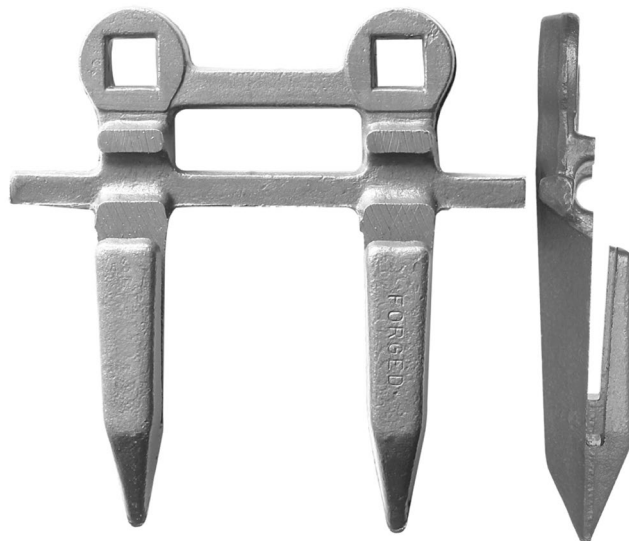

OEM	OEM PN#	Buchanan PN	Order No.	List
J.E. Love	LB208	BU-275	G81-0196	13.40
	LB214	BU-275		
New Holland	273846	BU-275		
	271971	BU-275		

Fits **J.E. Love** Combines – All floating heads. **New Holland** Combines – All floating heads.

Weight: 1.30 lb (589.69 g)

**HA280 (G81-0065)**



OEM	OEM PN#	Buchanan PN	Order No.	List
Ford	290385	BU-280	G81-0065	18.93
Massey Ferguson	1036339M1	BU-280		
	320423E1	BU-250		
New Idea	290385	BU-280		

Fits **Ford** Mower Conditioner – 535. **Massey Ferguson** Hay Tender (or Tedder) – 81. **New Idea** Mower Conditioners – 290, 299. Combine – 7135

Weight: 1.63 lb (739.39 g)

**HA290 (G81-0197)**



OEM	OEM PN#	Buchanan PN	Order No.	List
Versatile	9705050	BU-290	G81-0197	10.55
	SW-1605	BU-290		

Fits **Versatile** Windrowers – 10V, 400V, 440V, 1400V, 1950V, 2400V, 4400V

Weight: 1.40 lb (635.03 g)

**HA299 (G81-0037)**



OEM	OEM PN#	Buchanan PN	Order No.	List
Case IH	1307299C1	BU-299	G81-0037	11.03

Fits Case IH Combine – 1020

Weight: 1.87 lb (848.22 g)

**HA340 (G81-0026)**



OEM	OEM PN#	Buchanan PN	Order No.	List
John Deere	H25603	BC-340	G81-0026	22.93
	H153855	BC-340		
Massey Ferguson	1053174M1	BC-340		

Fits John Deere combines – All 3-prong applications. Massey Ferguson Combines – All 3-prong applications

Weight: 1.50 lb (680.39 g)

**HA610 (G81-0398)**



OEM	OEM PN#	Buchanan PN	Order No.	List
John Deere	H205448	BU610	G81-0398	15.32
	H213398			

Fits John Deere 600, 700 series flex heads.

**HA615 (G81-0399)**



OEM	OEM PN#	Buchanan PN	Order No.	List
John Deere	H213507	BU615	G81-0399	15.32
	AH205482			
	AH213055			
	H205447			
	H213400			

Fits John Deere 600, 700 series flex heads.

**HA630 (G81-0397)**



OEM	OEM PN#	Buchanan PN	Order No.	List
John Deere	H213408	BU630	G81-0397	15.33

Fits **John Deere** 600 series rigid and draper headers. 900 series draper heads.

**HA635 (G81-0396)**



OEM	OEM PN#	Buchanan PN	Order No.	List
John Deere	H213405	BU635	G81-0396	15.10

Fits **John Deere** 600 series rigid and draper headers. 900 series draper heads.

**HA630 (G81-0537)**

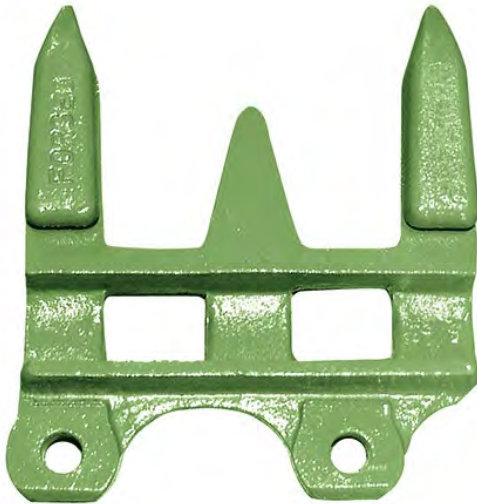

OEM	OEM PN#	Buchanan PN	Order No.	List
John Deere	H229537		G81-0537	11.76
			G81-0537G*	21.33

Fits **John Deere** 600, 700 series rigid and draper headers. 900 series draper heads. Double Heat Treated.

\*German Made

**HA635 (G81-0538)**



OEM	OEM PN#	Buchanan PN	Order No.	List
John Deere	H229538		G81-0538	11.76
			G81-0538G*	21.33

Fits **John Deere** 600, 700 series rigid and draper headers. 900 series draper heads. Double Heat Treated.

\*German Made

**HA641 (G81-0092)**



OEM	OEM PN#	Buchanan PN	Order No.	List
Case-IH	118301	NA	G81-0092	13.34
MacDon	118301	NA		

Fits **Case-IH** 1042, 1052, 2042, 2052, 2062, 2142, 2152, 2162. **MacDon** 972, D50, D60, D65, FD70, FD75. **New Holland** 84C, 86C.

Left hand overlap guard for double drive heads. 1 used per machine.

**HA642 (G81-0096)**



OEM	OEM PN#	Buchanan PN	Order No.	List
Case-IH	118302	NA	G81-0096	13.34
MacDon	118302	NA		

Fits **Case-IH** 1042, 1052, 2042, 2052, 2062, 2142, 2152, 2162. **MacDon** 972, D50, D60, D65, FD70, FD75. **New Holland** 84C, 86C.

Right hand overlap guard for double drive heads. 1 used per machine.

**HA643 (G81-0094)**



OEM	OEM PN#	Buchanan PN	Order No.	List
Case-IH	87422041	NA	G81-0094	13.34
MacDon	118345	NA		

Fits **Case-IH** 1042, 1052, 2042, 2052, 2062, 2142, 2152, 2162. **MacDon** 972, D50, D60, D65, FD70, FD75. **New Holland** 84C, 86C.

Guard for drive head areas. 2-6 used per machine.

**HA641 (G81-0973)**



OEM	OEM PN#	Buchanan PN	Order No.	List
Case-IH	118301	NA	G81-0973	14.12

Fits Case-IH 3020, 3152, 3162.

Main Guard

**HA642 (G81-0974)**



OEM	OEM PN#	Buchanan PN	Order No.	List
Case-IH	118302	NA	G81-0974	14.12

Fits Case-IH 3020, 3152, 3162.

Head Guard

# GUARDS

## MALLEABLE GUARDS

Fits 7/16" Bars. Fits all Mowers

Replaces	Description	Order No	List
DM700, T27293	Center Guard	G81-0803	7.05
DM700-R	Outer Guard	G81-0805*	9.95
FD800	Center Guard	G81-0807	8.62
MC2041Z	Center Guard	G81-0830	9.66

\*Does not fit Ford 505 mowers with 1/2" bars

Fits MASSEY FERGUSON Dyna Balance Mowers.

Replaces	Description	Order No	List
679837M91	Center Guard	G81-0181	12.80



## RIVET

For guard numbers G81-0803, G81-0805, G81-0807, G81-0778. 1-1/4" x 6 CS. 1/2 lb box.

Order No	List
R6-0468D	6.63

## GUARD BOLT/NUT

#3 bolt. Replaces L1316, L1317. 7/16" x 1-1/2". Grade 5 hardened.

Qty	Order No	List
50	B55-0260	19.95
10	B55-0260D	9.17



## GUARD BOLT/NUT

#3 bolt. Replaces LB318. 7/16" x 1-3/4". Grade 5 hardened.

Qty	Order No	List
50	B55-0265	22.43
10	B55-0265D	9.17



## CONICAL GUARD BOLT NUT

Package includes 5 7/16" nuts.

Order No	List
N83-0593D	3.29



## CARRIAGE BOLT/NUT

GR 5 Plated. 7/16" x 1-1/2". 50 nuts/bolts per package

Order No	List
B55-0150	19.95



## CARRIAGE BOLT/NUT

GR 5 Plated. 7/16" x 1-3/4". 50 nuts/bolts per package

Order No	List
B55-0145	19.95

## GUARD PLATE

Replaces Z5110H. For G81 0803. 10/box.

Order No.	List
P44-0646	19.36



## GUARD PLATE

Replaces 142570. For G81-0807. 10/box

Order No.	List
P44-0603	15.44



## RAKE WHEELS

Heavy Duty, .275. Fits Sitrex, Case, H&S, M&W, New Holland, Westward, AGCO, Atlas, Befco, Bush Hog, Hesston, Kelderman, MF, New Idea, Ogden, Otma, Panorama, Rhino and Ross.  
Painted Creme  
Overall diameter: 55"

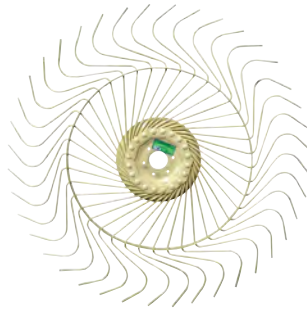

Description	Order No.	List
Right Hand	W16-0801	111.98
Left Hand	W16-0802	111.98

Replacement Tine Part Number T16-0815.

Heavy Duty, .276" (7mm). Fits Tonutti/National/Walton, John Deere/Frontier, Vermeer, Kuhn, Miller Pro/Arts Way, Gehl, Pequea.  
Painted Black  
Overall diameter: 55"

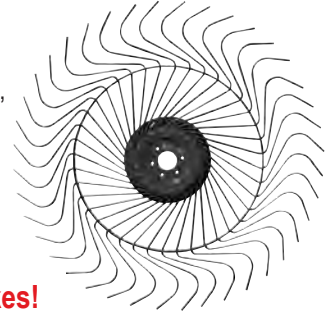

**Fits Kuhn Speed Rakes!**

Description	Order No.	List
Right Hand. P20BG003	W16-0805	111.98
Left Hand. P20BG004	W16-0806	111.98

Replacement Tine: T16-0497.

Heavy Duty, .275. Fits Sitrex, Case, H&S, M&W, New Holland, Westward & Others.  
Painted Black  
Overall diameter: 55"

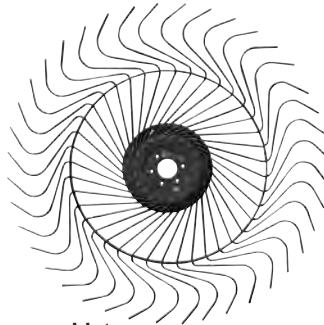

Description	Order No.	List
Right Hand	W16-0809	111.98
Left Hand	W16-0810	111.98

Replacement Tine Part Number T16-0815.

Heavy Duty, .276" (7mm). Fits Tonutti/National/Walton, John Deere/Frontier, Vermeer, Kuhn, Miller Pro/Arts Way, Gehl.  
Painted Creme  
Overall diameter: 55"

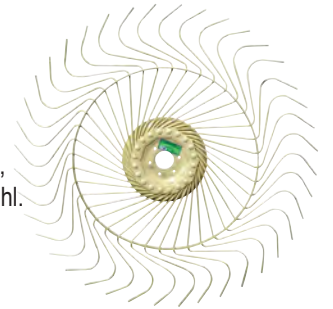

Description	Order No.	List
Right Hand. P20BG003	W16-0811	111.98
Left Hand. P20BG004	W16-0812	111.98

Replacement Tine: T16-0497.

## HIGH CAPACITY RAKE WHEEL

.295". Fits Sitrex, H&S, New Holland & Others.  
Painted Black  
Overall diameter: 60". Black.

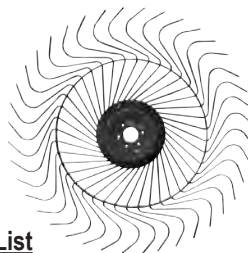

Description	Order No.	List
Right Hand	W16-0808	122.27
Left Hand	W16-0807	122.27

Replacement Tine Part Number T16-0495.

## HUB ASSEMBLY

Fits 55" & 60" Sitrex rake wheels. With bearing for all wheels listed at left. Pilot: 3.21". Bolt circle: 5.12". 13mm bolt required

Order No.	List
H16-1000	42.58



## TINE BOLT AND NUT

Fits Sitrex, Case, H&S, M&W, New Holland, Westward & All Others. 10 Per Blister Pack

Order No.	List
B55-0800D	12.56



## HERSCHEL POLY INSERTS

- Easy Installation - Pre-Drilled Holes
- Attaches To Rake Wheel With Heavy Duty Ties (Included)
- Increase Efficiency
- Prevents Wrapping
- Block Wind
- Inexpensive Add-On To Your Hay Rake



Application	OD	Center Hole	Order No.	List
Sitrex, AGCO, CIH, H&S, Hesston, Kelderman, MF, M&W, NH, New Idea, Ogden & Rhino	55"	31-3/8"	W16-55S	37.98
Tonutti, Gehl, Bush Hog, John Deere, Kuhn, Vermeer & Vicon	55	34-1/2"	W16-55T	43.92
Sitrex	60"	31-3/8"	W16-60S	53.33



## RAKE WHEEL SPRING

Fits H&S and other Wheel Rakes using lift springs on wheels. 1 used per hay turning wheel. 11" long. 1-7/8" OD. 1-1/2" ID. .238 Diameter wire

Order No.	List
S16-1000	13.08

## TEDDER RAKE TEETH

Replaces Number	OEM	Application	US #	Wire Color	Wire Gauge	A Length	B Width	C Coil OD	Pkg. Qty.	Order No	List
1-043-030-10700	Fahr		FT-1	Black	.344"	12-3/4"		2-1/4"	25	FT-1	12.85
10370000	Galfre	New Models	GS-1	Red	.375"	15-1/4"	3-1/2"	2-11/16"	20	T16-0814	14.74
	Galfre Rakes	280, GTS280		Black		13-1/2"	3-1/2"	2.787"	25	GT46S	12.39
		ST280 1995 & Newer. Tedders with black tines.									
	Hesston	3710, 3717, 3727, 3740		Black		13-1/2"	3-1/2"	2.787"	25	GT46S	12.39
278687	New Holland	156,158,162	KT-2	Yellow	.375"	13.875"	3-5/8"	2-3/4"	25	T16-0801	11.88
585-619-00	Kuhn	GF440, GF4000M									
585-052-10	Kuhn		KT-1	Yellow	.375"	13"		2-3/4"	25	T16-0802	13.83
576-090-00	Kuhn	GF22N, GF5000, GF6001	KT-3	Yellow	.375"	14.125"	3-5/8"	2-3/4"	25	T16-0803	11.87
	New Idea	4210, 4217, 4227		Black		16"	3-1/2"	2.787"		GT46S	12.39
10521L	Niemeyer		NM-2	Yellow	.375"	13"		2-5/16"	25	T16-0813	13.09
200-401, 210-574	Sitrex, Tonutti				.375"	10.3/4"		2-3/4"	25	T-2	10.86

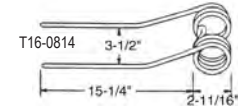
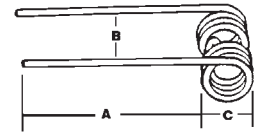

**WHEEL RAKE TOOTH**  
Replaces PR015, T-1. Right hand. Cream color. Wire gauge is .244". Old Style.  
OEM: Tonutti

Order No.            List             
T16-0808            1.95

**WHEEL RAKE TOOTH**  
Replaces PL015, T-1A. Left hand. Cream color. Wire gauge is .244". Old Style.  
OEM: Tonutti

Order No.            List             
T16-0809            1.95

**WHEEL RAKE TOOTH**  
For H&S, Sitrex, Atlas, Koehn & M&W. Replaces 203055, OT-1. Cream color. Wire gauge is .262".  
OEM: OTMA

Order No.            List             
T16-0810            1.86

**WHEEL RAKE TOOTH**  
For H&S, Sitrex, Atlas, Koehn & M&W. Replaces 203055, OT-1A. Cream color. Wire gauge is .281".  
OEM: OTMA

Order No.            List             
T16-0815            1.95

**WHEEL RAKE TOOTH**  
For Rossi and Durabilt. Replaces 6087-54, R-1. Cream color. Wire gauge is .262".  
OEM: Rossi

Order No.            List             
T16-0811            2.00

**WHEEL RAKE TOOTH**  
Replaces 70176116, 36133. Short 10", 6 Wheel. Tonutti. Black color. Wire gauge is .262".  
OEM: Vicon, Kuhn

Order No.            List             
T16-0489            1.86

**WHEEL RAKE TOOTH**  
Long 12-1/2", 5 Wheel. Replaces VI-2, 93611. Cream color. Wire gauge is .262".  
OEM: Vicon

Order No.            List             
T16-0490            1.95

**WHEEL RAKE TOOTH**  
For Sitrex and New Holland 60" rakes. .295" wire. 7" x 11-3/4" x 18". Black.  
OEM: Sitrex

Order No.            List             
T16-0495            2.25

**WHEEL RAKE TOOTH**  
For Kuhn Speed Rakes. Replaces 70176116. .278" wire.  
OEM: Kuhn

Order No.            List             
T16-0497            2.09





**RUBBER MOUNT LEFT HAND RAKE TOOTH**  
For NEW HOLLAND Rakes 56B, 27, 259, 216, 256, 258, 260, 269 & 216. Replaces 65668L.

Order No.            List  
T16-0154            3.60



**RUBBER MOUNT RIGHT HAND RAKE TOOTH**  
For NEW HOLLAND Rakes 56B, 27, 259, 216, 256, 258, 260, 269 & 216. Replaces 130941R.

Order No.            List  
T16-0166            3.42



**RUBBER MOUNT RAKE TOOTH**  
For HESSTON Rakes 3700, 3800, 3810, 3900, 3950. JOHN DEERE Twin Rake 700, 705. MF Rakes 585, 588. VERMEER R9, R21, R23, R23A, R24, R24A, R2300. Replaces EF2888001, AE56204. Right/Left hand. 1-5/8" inside saddle width, centered mounting holes. 100/box.

Order No.            List  
T16-0185            3.65



**RUBBER MOUNT RAKE TOOTH**  
For Round bar rakes. Universal. JOHN DEERE Rakes 640, 650, 660, 670, 672, 662, 652, 896A. NEW HOLLAND 55, 56, 57, 2560. Replaces 1/4 x 3/4 LPK, RMT-1, AE47389. Right hand. 1-11/16" inside saddle width. Offset mounting holes. 100/box.

Order No.            List  
T16-0182            2.07



**RUBBER MOUNT RIGHT HAND RAKE TOOTH**  
For Morrill, Farmahand, NI, Darf Rola Rake and Others. Replaces RMT2, 2117RH, 400341 and 491478. 10/box.

Order No.            List  
T16-0190            6.88



**HEAVY DUTY RUBBER MOUNT RAKE TOOTH**  
For Darf, Rowse and New Idea. Replaces RMT-2, 2117RLR, WR5901, 400341 and 491478. Heavy Duty.

Order No.            List  
T16-0195            5.99



**BEAN WINDROWER TOOTH**  
For Lockwood-Innes. Replaces H-60003. Single. 100/box.

Order No.            List  
T16-0016            368.00

## HERSCHEL 6" 2-PIECE POLY TINES FOR PIPE REELS

Fits: Agco-Gleaner 700, 800, 7000 & 8000 Series; Case-IH: 1010 & 1020 Series (2001 & Up), 2020; JD: 900 F & R Series s/n 685101 & Up, 600 Series; Massey Ferguson: 9800 & 9850 Series; New Holland: 71C, 73C, 972 & 973

Description	Pkg. Qty.	Order No.	List
Tine & Clamp	100/Box	T16-0740	198.88
Tine & Clamp	10/Box	T16-0745	21.80
Tine ONLY	100/Box	T16-0750	130.64



- PATENTED 2 PIECE DESIGN.
- SAVE MONEY!  
REPLACE ONLY THE TINE.

**ALLIS CHALMERS**

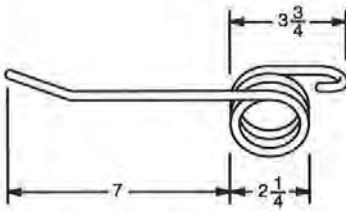

Order No. AC-1 2.84  
 531727  
 U.S. No. AC-1  
 Rake .244 Wire, Red  
 0.43 Lbs. 100/Case

**CASE**

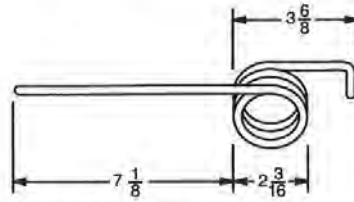

Order No. C-1 3.22  
 T-17350  
 U.S. No. C-1, Model 281  
 Rake (1960 on)  
 .244 Wire, Black  
 0.42 Lbs. 100/Case

**ALLIS CHALMERS**

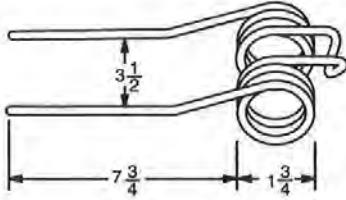

Order No. AC-2 5.39  
 511506  
 U.S. No. AC-2  
 Rake .244 Wire, Black  
 0.74 Lbs. 100/Case

**CASE**

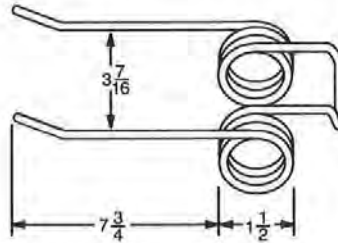

Order No. T16-0305 3.69  
 R-740S  
 U.S. No. C-2A  
 Rake .225 Wire, Black  
 0.5 Lbs. 100/Case

**FAHR**

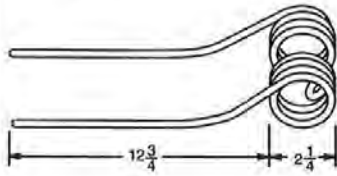

**Order No. FT-1 12.85**  
 1-043-030-10700  
 U.S. No. FT-1  
 Tedder .344 Wire, Black  
 2.0 Lbs. 25/Case

**GALFRE**

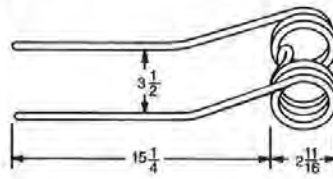

**Order No. T16-0814 14.74**  
 10370000  
 U.S. No. GS-1  
 Tedder .375 Wire, Black  
 2.8 Lbs. 20/Case

**INTERNATIONAL HARVESTER**

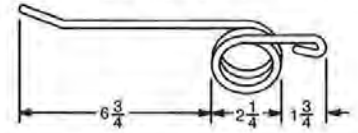

**Order No. T16-0126 2.36**  
 457374R1 / 462978R1  
 U.S. No. IH-1, IH-1A, IH-1B  
 Models 3, 4, 5, 8, 9, 11, 14, 15,  
 16, 30, 35, 86, 96, 97 Rakes  
 .225 Wire, Red  
 0.3 Lbs. 100/Case

**FARMHAND**

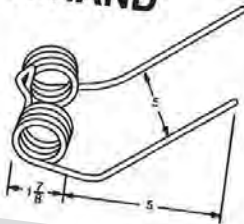

**Order No. T16-0368 5.35**  
 L2117/RH (ID-4803R)  
 U.S. FH-2  
 Model F-76  
 Rake  
 .262 Wire, Black  
 0.9 Lbs. 50/Case

**FORD**

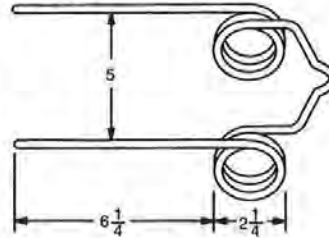

**Order No. T16-0340 4.83**  
 146545  
 U.S. No. F-2  
 Model 503 Rake .244 Wire, Black  
 0.8 Lbs. 50/Case

**INTERNATIONAL HARVESTER**

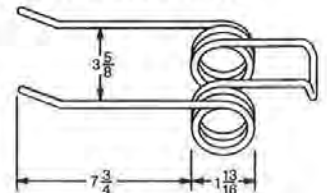

**Order No. IH-22-2 5.31**  
 455165R1  
 U.S. No. IH-22-2  
 Model 5, 1952 & up  
 Rake .244 Wire, Red  
 0.9 Lbs. 50/Case

**FORD**

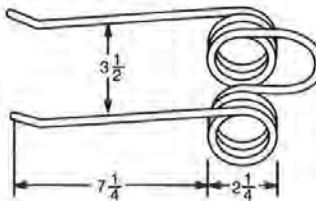

**Order No. F-2B 5.88**  
 143049  
 U.S. No. F-2B  
 Rake .244 Wire, Black  
 0.82 Lbs. 50/Case

\*Special Order Only. Minimum Order Required

## JOHN DEERE

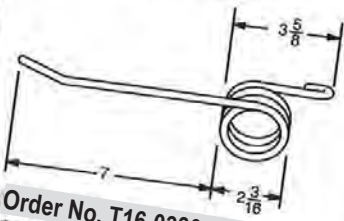

Order No. T16-0330 2.32

257-SE  
U.S. No. JD-1  
Model 350, 851, 858, 894, 896  
Rakes 24T, 216T Balers  
.244 Wire, Green  
0.4 Lbs. 100/Case

## JOHN DEERE

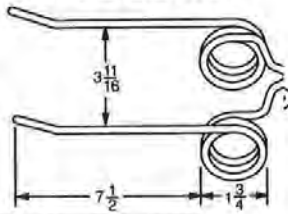

Order No. T16-0320 4.07

186SE  
U.S. No. JD-2G  
Models 553, 594  
Side Delivery Rake  
.244 Wire, Black  
0.7 Lbs. 100/Case

## KUHN

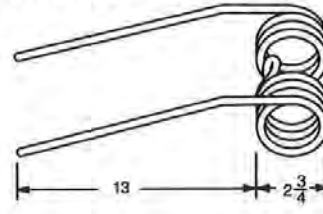

Order No. T16-0802 13.83

585-052-10  
U.S. No. KT-1  
Tedder  
.375 Wire, Yellow  
2.5 Lbs. 25/Case

## JOHN DEERE

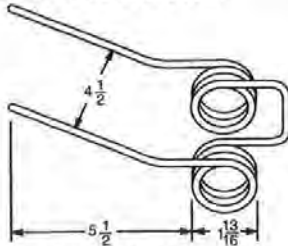

Order No. T16-0315 5.37

E35277  
U.S. No. JD-1A  
Model 567 Wheel Rake  
.262 Wire, Black  
0.9 Lbs. 50/Case

## KELLY RYAN

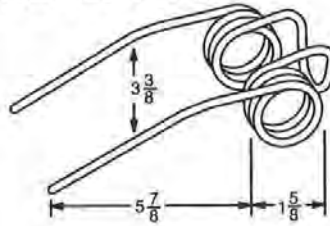

Order No. KR-2L\* 4.07

RR14L  
U.S. No. KR-2L  
Rake .244 Wire, Black  
0.7 Lbs. 100/Case

## KUHN

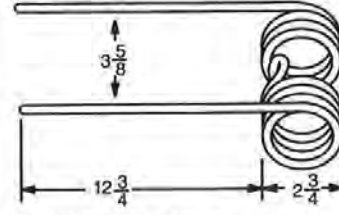

Order No. T16-0801 11.88

585-619-00  
U.S. No. KT-2  
Tedder Model GF440,  
GF4000M  
.375 Wire, Yellow  
2.5 Lbs. 25/Case

## JOHN DEERE

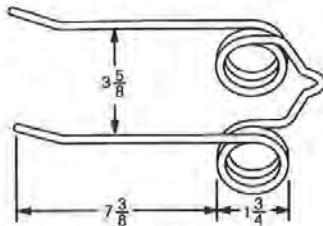

Order No. T16-0325 3.74

194SE / 237SE  
U.S. No. JD-2  
Model 14, 596, 597, 714 Rakes  
.225 Wire, Black  
0.6 Lbs. 100/Case

## KUHN

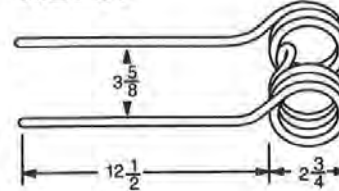

Order No. T16-0803 11.87

576-090-00  
U.S. No. KT-3  
Tedder Models GF22N,  
GF5000, GF6001  
.375 Wire, Yellow  
2.5 Lbs. 25/Case

\*Special Order Only. Minimum Order Required

**MASSEY FERGUSON**

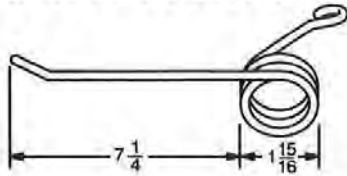

Order No. T16-0335 2.80

667530M0 / 668364M1  
DE03435A  
U.S. No. MF-1, MF-1C, MF-1D  
Models 25, 36, 37  
Rakes .262 Wire, Black  
0.4 Lbs. 100/Case

**NEW HOLLAND**

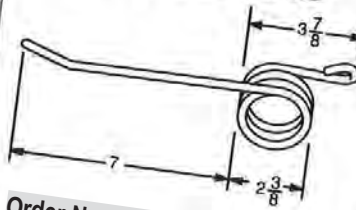

Order No. T16-0370 2.20

64562 / 46993  
U.S. No. NH-1A  
Model 55, 56B & 57 Rakes  
256, 258, 259, 260  
Rotobar .262 Wire, Yellow  
0.5 Lbs. 100/Case

**CLIP**

for T16-0370. 10 per bag.

Order No. List  
C45-0493B 9.52

**MASSEY FERGUSON**

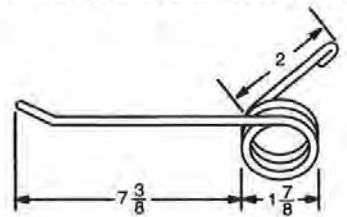

Order No. T16-0367 2.44

667656M1  
U.S. No. MF-1A  
All Rakes to 1958  
.244 Wire, Black  
0.3 Lbs. 100/Case

**NEW IDEA**

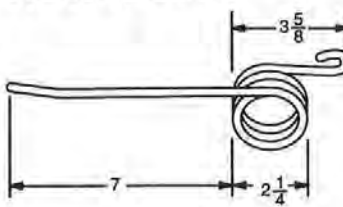

Order No. NI-1 2.56

0782ME1  
U.S. No. NI-1  
Rakes 1957 on  
.244 Wire, Green  
0.4 Lbs. 100/Case

**NEW HOLLAND**

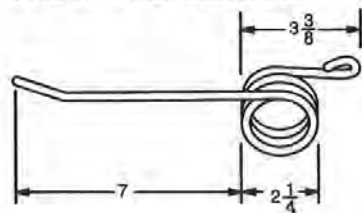

Order No. NH-1 1.92

40917  
U.S. No. NH-1  
Model 55 Rake 1950  
.244 Wire, Yellow  
0.4 Lbs. 100/Case

**NEW IDEA**

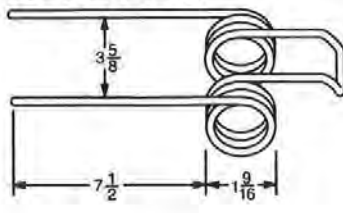

Order No. T16-0380 3.32

048ME & M8  
U.S. No. NI-2  
Model (4 Bar) 4, 44, 45G,  
1948 & up  
.244 Wire, Green  
0.7 Lbs. 100/Case

**OLIVER**

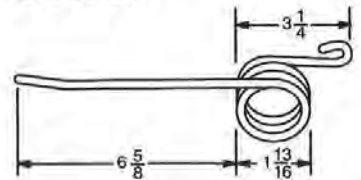

Order No. O-1 2.84

500629E  
U.S. No. O-1  
Model 107 (5 Bar)  
Side Del. Rake, A1 Roto Bar  
.262 Wire, Black  
0.4 Lbs. 100/Case

\*Special Order Only. Minimum Order Required

**OTMA**

Order No. T16-0810D 18.92  
 203055  
 U.S. No. OT-1  
 Wheel Rake  
 .262 Wire, Cream  
 0.5 Lbs. 100/Case  
 Note: Also fits H&S, Sitrex and Atlas Wheel Rakes

**POLLARD**

Order No. T16-0390 2.59  
 1706  
 U.S. No. P-1A-1  
 Rake .262 Wire, Black  
 0.4 Lbs. 100/Case

**TONUTTI**

Order No. T16-0808D 19.45  
 PR015  
 U.S. No. T-1  
 Wheel Rake, Right Hand  
 .244 Wire, Cream  
 0.5 Lbs. 100/Case

**POLLARD**

Order No. T16-0395 2.84  
 7D265  
 U.S. No. P-1B  
 Rake  
 .262 Wire, Black  
 0.4 Lbs. 100/Case

**TONUTTI**

Order No. T16-0809D 19.45  
 PL015  
 U.S. No. T-1A  
 Wheel Rake Left Hand  
 .244 Wire, Cream  
 0.5 Lbs. 100/Case

\*Special Order Only. Minimum Order Required

### CASE

Order No. T16-0030 3.93  
750075  
U.S. No. HE-2  
Made by Hesston  
.225 Wire, Red  
0.75 Lbs. 100/Case

### INTERNATIONAL HARVESTER

Order No. T16-0128 3.73  
540565R1  
U.S. No. IH-2G  
Model 9901190  
.225 Wire, Red  
0.6 Lbs. 100/Case

### NEW HOLLAND

Order No. T16-0032 4.15  
76517  
U.S. No. NH-2E  
Haybine Models 460, 461, 467,  
468, 472, 474, 488, 492, 903,  
907, 909, 912, 1100, 1112, 1114,  
Self Propelled model 1118  
.225 Wire, Yellow  
0.65 Lbs. 50/Case

### JOHN DEERE

Order No. JD-2E 3.60  
E37596  
U.S. No. JD-2E  
Models 480, 483, 485,  
old models 1207, 1209, 1214  
.225 Wire, Yellow  
0.58 Lbs. 100/Case

### NEW HOLLAND

Order No. NH-3 2.25  
241379R  
U.S. No. NH-3  
Model 1495 & 1495  
Self propelled 495, 488 & 499  
Pull Behind  
.244 Wire, Yellow  
0.5 Lbs. 100/Case

### HESSTON

Order No. T16-0030 3.93  
750075  
U.S. No. HE-2  
Models PT-7, PT-10, PT-12, 1012,  
1014, 1070, 1090, 420, 620, 6600  
.225 Wire, Red  
0.7 Lbs. 100/Case

### JOHN DEERE

Order No. T16-0332 4.15  
E-10711  
U.S. No. JD-2E-1  
Models 1207, 1209, 1217, 1210,  
1380, 230 new models  
.244 Wire, Yellow  
0.7 Lbs. 100/Case

## FREEMAN

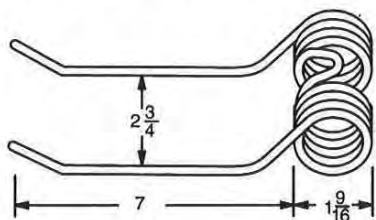

Order No. T16-0226 3.53

F1226  
U.S. No. FR-1  
Baler .187 Wire, Black  
0.4 Lbs. 100/Case

## HESSTON

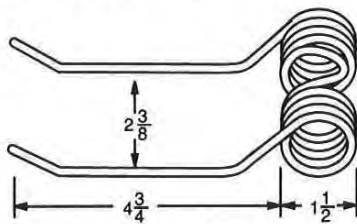

Order No. T16-0012 3.28

7894751  
U.S. No. HE-3  
Baler .187 Wire, Red  
0.4 Lbs. 100/Case

## HESSTON

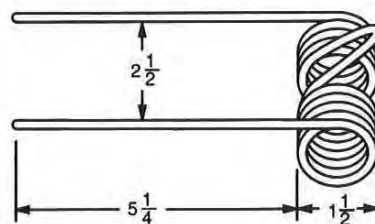

Order No. HE-6 4.37

2700222/1710102  
U.S. No. HE-6  
Baler .187 Wire, Red  
0.4 Lbs. 100/Case

## HESSTON

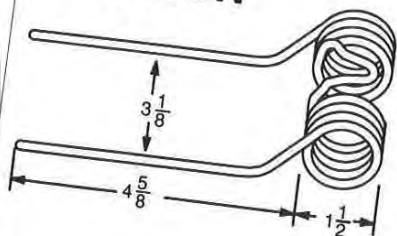

Order No. T16-0040 3.67

7751621  
U.S. No. HE-1  
Models 5600 & 5800 Balers  
.187 Wire, Red  
0.4 Lbs. 100/Case

## HESSTON

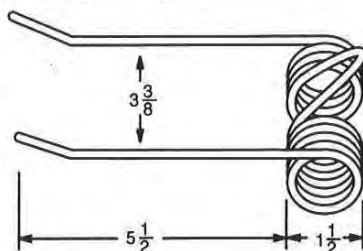

Order No. HE-5 4.73

7894306  
U.S. No. HE-5  
Baler .225 Wire, Red  
0.6 Lbs. 100/Case

## HESSTON

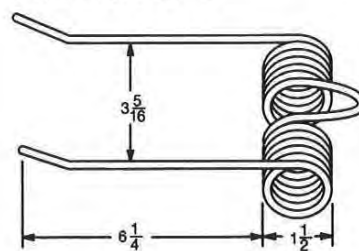

Order No. T16-0164 5.10

7893746  
U.S. No. HE-7  
4800 Baler .207 Wire, Red  
0.7 Lbs. 100/Case

## INTERNATIONAL HARVESTER

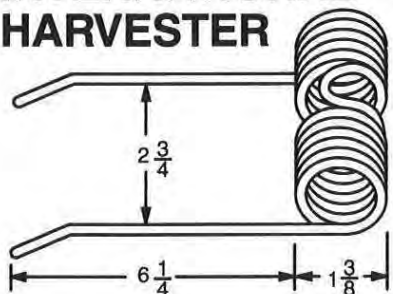

Order No. IH-2A 3.82

210614-C1  
U.S. No. IH-2A  
Baler .177 Wire, Black  
0.5 Lbs. 100/Case

## INTERNATIONAL HARVESTER

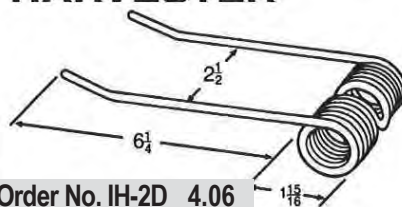

Order No. IH-2D 4.06

700709210 / 700714459  
U.S. No. IH-2D  
Models Case IH 8430, 8440, 8480  
Hesston 514, 540, 740, 840  
MF 1744  
NI 4644, 6244, 6344  
Balers .193 Wire, Black  
.7 Lbs. 100/Case

## HESSTON

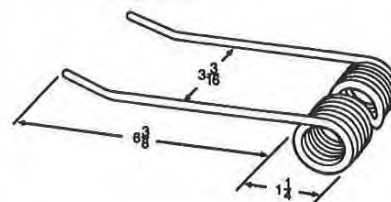

Order No. T16-0163 5.06

700706128  
U.S. No. HE-8  
Baler .207 Wire, Red  
Models 4460 & 4650  
.7 Lbs. 100/Case



**INTERNATIONAL HARVESTER**

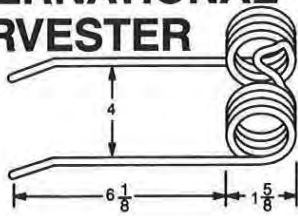

**Order No. IH-2B 4.03**

MA-74528  
U.S. No. IH-2B  
Models 45, 45T, 46, 55T, 55W, 435, 445, Balers  
Models 15, 16, 55, 350, 550, 650, 200, 36, Forage Harvester  
Model 122, 123, 125, 127, 141, 151, 161  
Combines .177 Wire, Red  
0.5 Lbs. 100/Case

**INTERNATIONAL HARVESTER**

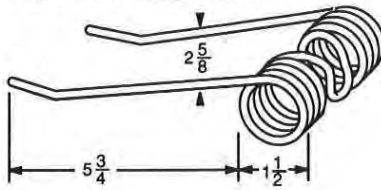

**Order No. NI-3 3.64**

ZA103012  
U.S. No. NI-3 Model 3650  
Baler .193 Wire, Black  
0.44 Lbs. 100/Case

**JOHN DEERE**

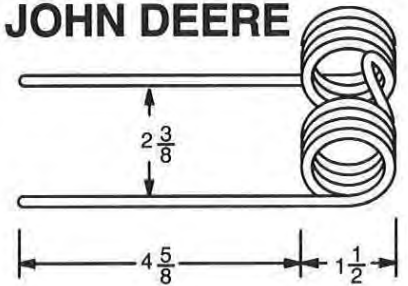

**Order No. T16-0025 2.47**

E61295 / E67036  
U.S. No. JD-1D  
Models 410, 430, 500, 510, 530,  
Round Balers .187 Wire, Yellow  
0.43 Lbs. 100/Case

**JOHN DEERE**

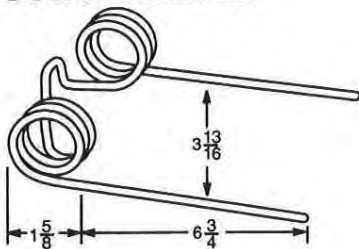

**Order No. T16-0022 3.20**

276-SE  
U.S. No. JD-2B  
Models 14T, 24T, 214T Balers  
.187 Wire, Green  
0.4 Lbs. 100/Case

**JOHN DEERE**

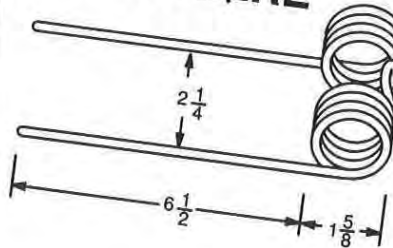

**Order No. T16-0024 2.76**

E41833  
U.S. No. JD-1C  
Models 327, 336, 346, 337, 347, 467  
Round Balers .177 Wire, Yellow  
0.45 Lbs. 100/Case

**JOHN DEERE**

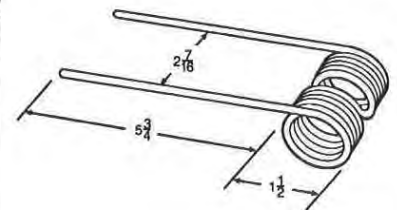

**Order No. JD-1D-2 3.22**

E-79475  
U.S. No. JD-1D-2  
Round Balers, 535 Baler  
.187 Wire, Green  
0.52 Lbs. 100/Case

**MASSEY FERGUSON**



**Order No. T16-0488 5.47**

4000-997, 27997-001  
Models 1440, 1455, 1550, 1565.  
Round Balers. 7"

\*Special Order Only. Minimum Order Required

## MASSEY FERGUSON

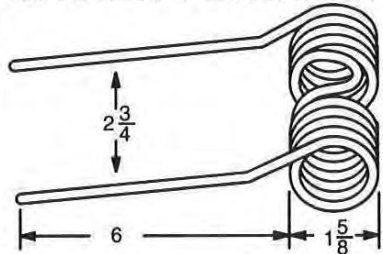

Order No. MF-2B 3.81  
151075M2  
U.S. No. MF-2B  
Balers up to 1958  
.187 Wire, Black  
0.4 Lbs. Packed 100/Case

## NEW HOLLAND

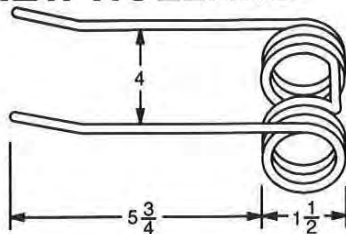

Order No. T16-0158 2.76  
127566  
U.S. No. NH-1B  
Model 78, 67, Super 68, 69,  
268, 269, 270 Balers  
.187 Wire, Yellow  
0.4 Lbs. 100/Case

## NEW HOLLAND

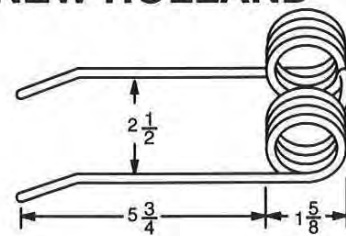

Order No. NH-1D-1 3.23  
683310  
U.S. No. NH-ID-1  
Model 855 Round Baler  
up to series 733, 139  
.187 Wire, Yellow  
0.5 Lbs. 100/Case

## MASSEY FERGUSON

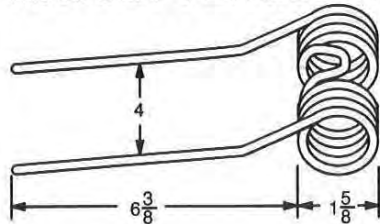

Order No. MF-2C 5.32  
665929M1  
U.S. No. MF-2C  
Models 3, 9, 10, 12 Balers up to 1958  
.207 Wire, Black  
0.6 Lbs. Packed 100/Case

## NEW HOLLAND

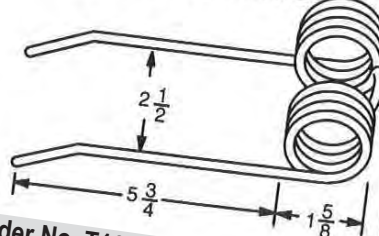

Order No. T16-0162 3.24  
131673  
U.S. No. NH-1D Replaces 86551419  
Models 660, 845, 846, 847, 850, 851, 852  
Supersweep & Lg. Round Balers  
.187 Wire, Yellow  
0.5 Lbs. 100/Case

## NEW HOLLAND

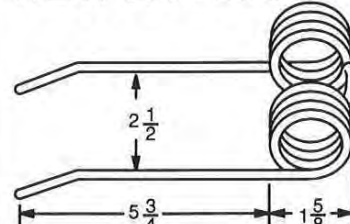

Order No. NH-1D-2 3.82  
788853  
U.S. No. NH-ID-2  
Model 855 Round Baler  
Series 733, 140 to 786, 144  
.187 Wire, Yellow  
0.5 Lbs. 100/Case

## NEW HOLLAND

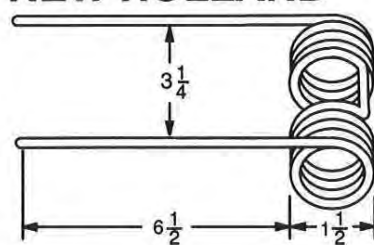

Order No. NH-2C 2.83  
28286  
U.S. No. NH-2C  
Baler .187 Wire, Yellow  
0.4 Lbs. 100/Case

## NEW IDEA

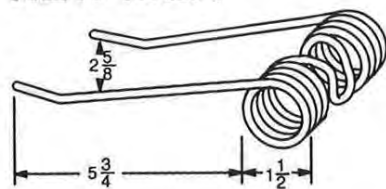

Order No. NI-3 3.64  
103012  
U.S. No. NI-3  
Model 465 and 480, 485, 486,  
484, 483.  
Round Baler .193 Wire, Black  
0.44 Lbs. 100/Case

## NEW IDEA

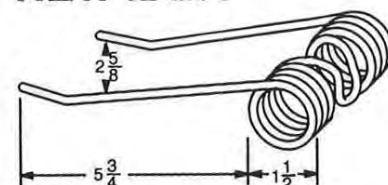

Order No. NI-3 3.64  
103012  
U.S. No. NI-3  
Model 465 and 480, 485, 486,  
484, 483.  
Round Baler .193 Wire, Black  
0.44 Lbs. 100/Case

**OWATONNA/OMC**

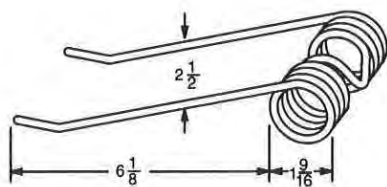

Order No. OW-2 5.12

11032347  
U.S. No. OW-2  
Models 590, 595, 596  
Round Balers .230 Wire, Black  
.5 Lbs. 100/Case

**VERMEER**

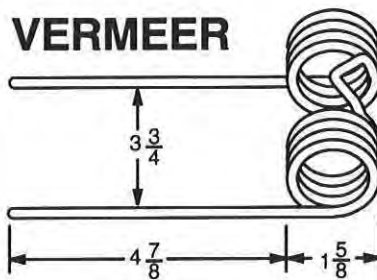

Order No. V-1 4.16

F-413 / 48893001  
U.S. No. V-1  
B & C Series Balers  
.187 Wire, Yellow  
0.5 Lbs. 100/Case

**VERMEER**

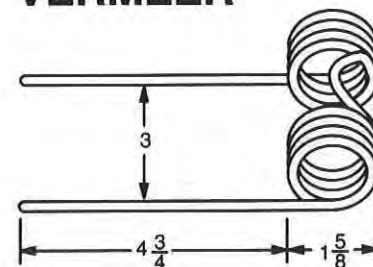

Order No. V-2 3.78

F-1326/29-001  
U.S. No. V-2  
D Series Baler .187 Wire,  
Yellow, 0.5 Lbs. 100/Case

**VERMEER**

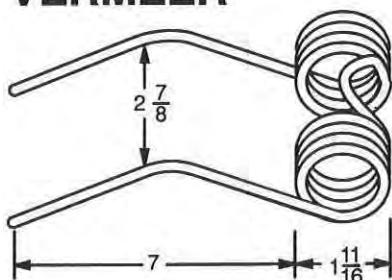

Order No. T16-0485 3.65

4059-001  
U.S. No. V-3  
E, F, & G Series Balers  
.207 Wire, Black  
0.6 Lbs. 100/Case

**VERMEER**



Order No. T16-0488 5.47

4000-997, 27997-001  
Models Super F, G, H I, J, K, L, XL  
& Rebel Series. 150, 1450, 504,  
505/5410, 5410, 5500.  
Round Balers. 7"

# POLY PICKUP TEETH

Feature a flexible high impact poly. Uses a quarter inch support ring on the inside to strengthen and maintain shape. Mounting hardware included.

- *Won't Bend and Wear Like Steel Ones*
- *Hay Feeds Through Smoothly and Easily*
- *Quieter Operating Baler. No Metal Bands For Pickup Teeth To Rub On.*

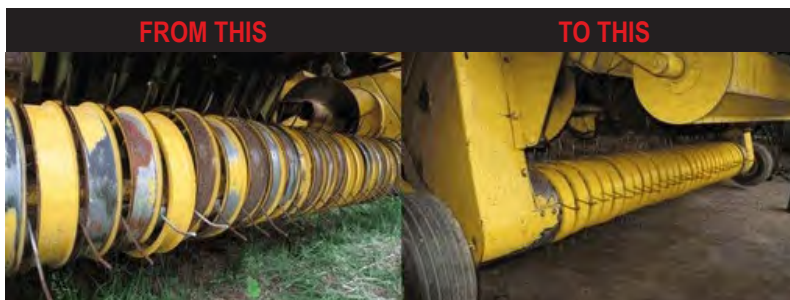

**Sold In Boxes Of 12. Listd as each.**

APPLICATION	OEM PART #	COLOR	ORDER NO	LIST
<b>CASE IH LARGE SQUARE BALER STANDARD CUT</b> MODELS LB333P; LB333S; LB433S; LBX421S; LBX432S; LBX331P; LBX331S; LBX332P, LBX332S; LB334P; LB334S; LB434S	8446827, 84607815, 84801631, 84214800, 84274387	Black	H84801631	<b>29.86</b>
<b>CASE IH; HESSTON; CHALLENGER &amp; NEW IDEA LARGE SQUARE BALERS</b> CIH 8550, 8570, 8575, 8585; CHALLENGER LB33, LB34, LB44; HESSTON 4750, 4755, 4760, 4790, 4910; NEW IDEA 7233, 7234, 7244, 7333	700108607, 700129658	Grey	H700129658	<b>28.29</b>
<b>JOHN DEERE ROUND BALERS</b> 330, 335, 375, 385, 430, 435, 447, 448, 449, 456, 458, 459, 466, 467, 468, 469, 535, 545, 546, 547, 550, 556, 558, 559, 566, 568, 569, 570, 572, 580, 582, 590, 592	CC32669, E85043, FH311772	Green	H311772	<b>35.08</b>
<b>NEW HOLLAND ROUND BALERS</b> 644 (9/95-9/98); 648 (8/98-6/02); 654 (8/95-9/98); 658 (8/98-6/02); 664 (9/95-9/98); 678 (2/99-6/02); 688 (8/98-6/02)	86637149	Yellow	H86637149	<b>35.08</b>
BR730A (9/05-6/07) Prior to P.I.N. Y7N030706; BR740 (10/02-7/05); BR740A (9/05-6/07)	86637149 / 86512793	Yellow	H86637149	<b>35.08</b>
BR7080 (7/07-2/14); BR7090 (7/07-2/14); BR770 (2/03-7/05); BR770A (9/05-6/07); BR780(7/02-7/05); BR780A (9/05-6/07)	87041203	Yellow	H87041203	<b>37.59</b>
BR7060 (7/07-2/14); BR7070 (7/07-2/14); BR7090 (7/07-2/14); BR740 (10/02-7/05); BR740A (9/05-6/07); BR750 (9/02-7/05); BR750A (9/05-6/07); BR780A (9/05-6/07). All with pickup width 70-3/4" first to last tooth.	87055364	Yellow	H87055364	<b>35.08</b>
BR7060 (7/07-2/14); BR7070 (7/07-2/14); BR7090 (7/07-2/14); BR740 (10/02-7/05); BR740A (9/05-6/07); BR750 (9/02-7/05); BR750A (9/05-6/07); BR780 (7/02-7/05); BR780A (9/05-6/07). All with pickup width 43" first to last tooth.	86643380 86619048	Yellow	H86643380	<b>35.08</b>
<b>NEW HOLLAND LARGE SQUARE BALERS STANDARD CUT</b> BB940AP; BB940S; BB960AS; BB960S; BB960S; BB9080S; BB9060P; BB9070S; BB9340AP; BB940AS; BB940P; BB960S; BB940P; BB940S; BB980; 590; 595; 330P; 330S; 340S	84801630, 89837845, 85005357, 84214799, 84274388; 84468629	Yellow	H84801630	<b>28.29</b>
<b>VERMEER ROUND BALER</b> I, SUPER I, J, SUPERJ, K, L, XL, SUPER M, N RANCHER, REBEL	89962001	Yellow	H89982001	<b>35.08</b>

## FREE SHIPPING ON BALER BELTS ORDERS OVER \$150.00!

### Keys to Successful Baler Belt Replacement

1. Replace all belts at the same time.
2. If you do decide to replace a few select belts, resize the old ones to match the new ones.
3. All belts should be the same ply. Two and three-ply belts will not carry the same tension and will not operate properly when mixed.
4. Three-ply texture belts work great for heavy-duty applications such as high density bales and silage bales due to their reduced slippage.
5. Eliminate catch points such as weld splatters, sharp edges and debris.
6. Check for bent or broken rollers.
7. Check all bearings.

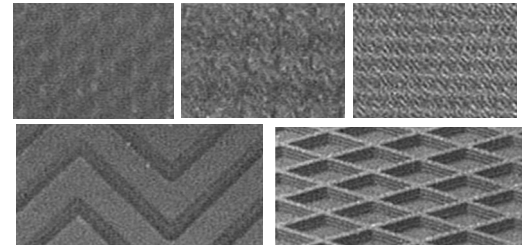

Chevron

Diamond

**We Carry Many Additional Models And Styles Not Listed Here. Please Call for List and Availability.**

		2-PLY BELTS					3-PLY BELTS			
Mfg.	Model	Position	Belts Per Baler	Belt Size	Type	Order No.	List	Type	Order No.	List
AC	Roto Baler	Upper	6	5.5" x 72"	Textured	AC750AF2	52.43			
		Lower	6	5.5" x 102"	Textured	AC700AF2	62.52			
Case/IH	3450	Upper (Early)	30	4.75" x 73.25"	Textured	UN776AF2	54.50			
		Upper (Newer)	15	11" x 73.25"	Textured	UN768AF2	94.88			
Case/IH	3640	Upper	20	11" x 73.25"	Textured	UN768AF2	94.88			
Case/IH	3650	Upper (Early)	55	4.75" x 73.25"	Textured	UN776AF2	54.50			
		Upper (Newer)	25	11" x 73.25"	Textured	UN768AF2	94.88			
Case/IH	8420	Upper	5	4.8" x 364"				Chevron	UN710ANC2	202.81
Case/IH	8480	Upper	25	11" x 73.25"	Textured	UN768AF2	94.88			
Ford	551	Upper (Inner)	3	5" x 450"				Textured	UN726AN2	183.94
		Upper (Outer)	2	6" x 450"				Textured	UN725AN2	206.54
Ford	552	Upper	6	6" x 466"	Textured	UN775AF2	187.30			
		Lower	1	60" x 96"	Textured	UN702AF2	750.38			
Gehl	1400	Upper (Inner)	3	5" x 450"				Textured	UN726AN2	183.94
		Upper (Outer)	2	6" x 450"				Textured	UN725AN2	206.54
Gehl	1500	Lower	1	60" x 96"	Textured	UN702AF2	750.38			
Gehl	1500A, 1600	Upper	6	6" x 466"	Textured	UN775AF2	187.30			
		Lower	1	60" x 96"	Textured	UN702AF2	750.38			
Gehl	1850, 1860	Upper	7	6" x 546"				Textured	GB765AN2	240.84
		Upper	8	6" x 546"				Textured	GB765AN2	240.84
Hesston	514	Upper	25	11" x 73.25"	Textured	UN768AF2	94.88			
		Upper	5	4.8" x 364"				Chevron	UN710ANC2	202.81
Hesston	530, 5530	Upper	5	4.8" x 364"				Chevron	UN710ANC2	202.81
Hesston	5400	Upper (not punched)	9	4" x 127"	Textured	HE725AF2	70.54			
Hesston	5540	Upper	6	5.3" x 470"	Textured			Chevron	UN740ANC2	244.81
Hesston	5580	Upper	8	5.3" x 470"	Textured			Chevron	UN740ANC2	244.81
Hesston	5800	Upper	9	4" x 480"	Textured	HE775AF2	141.03	Chevron	HE775AF2	141.03
John Deere	410	Upper	Optional	12" x 415"	Textured	LJD727AF2	312.06			
John Deere	430, 435	Upper	4	7" x 525"				Diamond	LJD735AND2	330.46
John Deere	510	Upper	9	4" x 484"	Textured	LJD775AF2	141.87			
John Deere	530, 535	Upper	4	7" x 525"				Diamond	LJD735AND2	330.46
		Upper	4	7" x 531"				Diamond	LJD736AND2	312.55
Massey	560	Upper	9	4" x 440"	Textured	UN735AF2	141.24			
Massey	645	Upper	6	6.5" x 528"	Textured	UN795AF2	218.79	Textured	UN795AN2	234.90
Massey	1565	Upper	6	4" x 512"				Textured	UN745AN2	168.98
		Upper (inner Optional)	2	10" x 512"				Textured	UN746AN2	367.50
New Idea	483, 484	Upper (Early)	30	4.75" x 73.25"	Textured	UN776AF2	54.50			
		Upper (Newer)	15	11" x 73.25"	Textured	UN768AF2	94.88			
New Idea	485	Upper	15	11" x 73.25"	Textured	UN768AF2	94.88			
Vicon	560	Upper	25	11" x 73.25"	Textured	UN768AF2	94.88			
Vicon	RP1510	Upper	55	4.75" x 73.25"	Textured	UN776AF2	54.50			
		Upper (Newer)	25	11" x 73.25"	Textured	UN768AF2	94.88			
Vermeer	605C	Upper	9	4" x 440"	Textured	UN735AF2	141.24			
Vermeer	605D	Upper	9	4" x 450"				Textured	VR725AN2	150.99
		Upper	Optional	10" x 450"	Textured	VR726AN2	329.24	Textured	VR726AN2	329.24
Vermeer	605E	Upper (Modification)	5	4" x 440"	Textured	UN735AF2	141.24			
Vermeer	605F, 605G, 605H	Upper	6	4" x 512"				Textured	UN745AN2	168.98
		Upper (Inside)	Optional 2	10" x 512"				Textured	UN746AN2	367.50
Vermeer	605J, 605 Super J	Upper	8	6.5" x 528"	Textured	UN795AF2	218.79	Textured	UN795AN2	234.90
Vermeer	605K	Upper	2	6.5" x 528"	Textured	UN795AF2	218.79	Textured	UN795AN2	234.90

### UNIVERSAL SPLICE ACCESSORIES

Description	Order No.	List
Clipper .109 dia connecting pin. 15'	B22-5001	47.59
4 - 7" Clipper 3-4-1/2 HT splices per card	B22-5003	17.67
8 - 4" Clipper 4-1/2 RHTX splices per card	B22-7004	30.84
4 - 7" Clipper 4-182 RHTX splices per card	B22-7007	27.01
4 - 7" Alligator rivet laces strips per card	B22-7009	82.20
8 Alligator corrugated pins per card	B22-7010	49.09
7" vise for clipper lacing	CVICE7	245.25

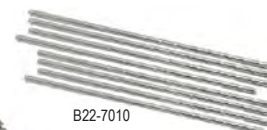

# GATHERING WHEELS

## POPULAR ROUND BALER BELTS

- Nylon fabric reinforcement in the outer ply to help the belt stretch under heavy loads.
- Polyester center ply helps lace retention and stabilize belt
- Belt & lacing meet or exceed OEM specifications
- 3-Ply belt offers increased durability saving downtime.

Make/Model	Description	Order No.	List
<b>CASE-IH</b>			
RBX461, 561, 562 NH, 650, 654, BR750, 660, 664, 668, 780, BR780	7" X 420.5" 3-Ply Mini Rough Top With Clipper	CNH7X420MC	<b>344.58</b>
<b>JOHN DEERE</b>			
430, 435, 466, 467, 530, 535, 566, 567	7" x 531" 3-Ply Diamond Top With Alligator Lacing 7" x 525" 3-Ply Diamond Top With Alligator Lacing	JD7X531DA JD7X525DA	<b>425.14</b> <b>421.15</b>
<b>VERMEER</b>			
504 I (older model), 504-IS(silage), 505 Super I, 504 Super I, 5400 Rebel, 504L, 505-I (older model)	6" x 424" 3-Ply LMP Top With Clipper Lace	VER6X424IMC	<b>294.98</b>

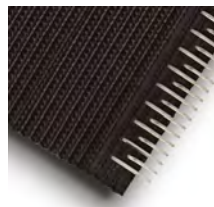

Mini Rough Top



Diamond Top

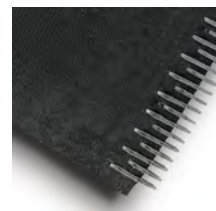

LMP Top

## GATHERING WHEELS

Unique blend of rubber compounds offering durability and performance. The tough rubber fingers resist breakage and provide a longer service life.

Make/Model	Description	Order No.	List
<b>CASE-IH</b>			
8450 & 8455	24" x 9" Hub & Wheel 24" x 9" Gathering Wheel	W29-0400 W29-0405	<b>350.56</b> <b>139.69</b>
<b>GEHL</b>			
1500, 1600, 1850, 1860	28" x 12 Gathering Wheel	W29-0415	<b>178.50</b>
<b>HESSTON</b>			
530, 540, 745	24" x 9" Hub & Wheel Replacement Wheel	W29-0400 W29-0405	<b>350.56</b> <b>139.69</b>
550, 555, 560, 565	Wheel Wedge (3 per wheel)	W29-0410	<b>41.43</b>
5540 & 5545	Wheel Wedge (3 per wheel)	W29-0410	<b>41.43</b>
5580 & 5585	Wheel Wedge (3 per wheel)	W29-0410	<b>41.43</b>
<b>JOHN DEERE</b>			
430, 435, 466, 467	Wheel Wedge (3 per wheel)	W29-0410	<b>41.43</b>
<b>MASSEY FERGUSON</b>			
1560, 1745	24" x 9" Gathering Wheel	W29-0405	<b>139.69</b>
<b>NEW HOLLAND</b>			
640, 648, 660, 688	28" x 12 Gathering Wheel	W29-0415	<b>178.50</b>
<b>VERMEER</b>			
504 I, 504 L, 504 SI, 505 I, 504 SI, 554 XL, 555 XL, 604 J, 604 K, 605 J, 605 K, 604 L, 605L, 605 SJ, 604 SJ, 604 XL, 605 XL, 5400 Rebel, 5410 Rebel, 5420 Rebel, 5500 Rebel, 5520 Rebel, 540 M Classic, 664 Rancher, 665 Rancher, 6640 Rancher, 6650 Rancher	24" x 9" Gathering Wheel	W29-0405	<b>139.69</b>
504 F, 504 G, 504 H, 605 F, 605G, 605H	28" x 12" Gathering Wheel	W29-0415	<b>178.50</b>



W29-0400

### HUB AND GATHERING WHEEL ASSEMBLY

Gathering wheel hub and wheel assemblies are available to replace older style wheels commonly found on many earlier baler models. Wheel assembly can be mounted on either side by simply loosening the bolts and reversing the hub assembly. Bearings not included.



W29-0405

W29-0415

### GATHERING WHEEL

Wheels provide the reliable performance you expect from OEM quality gathering wheel. Bolt holes are pre-punched for ease of installation and offered pattern fits most balers equipped for this wheel style.



W29-0410

### WHEEL WEDGE

Die-cut from 4-ply 440 1/4" x 1/16" grade 2 industrial conveyor belt, three segments can be combined to make a single wheel. Segments provide a durable and economical wheel option and is ideal for certain older model balers.

## DISC MOWER SPECIFICATIONS

Application	Shape	Degree Of Twist	Length	Width	Thickness	Hole Diameter	Center Of Hole To Back Edge	Order No.	
Gehl, John Deere, Kuhn, NH	LH	Twisted	13	3.75	1.78	0.140	0.64	0.75	B45-6122D
Gehl, John Deere, Kuhn, NH	RH	Twisted	13	3.76	1.72	0.130	0.64	0.78	B45-6123D
New Holland, Kuhn	Both	Flat	0	3.78	1.55	0.110	0.64	0.71	B45-6175D
CIH, Gehl, MF, New Idea, Vicon	LH	Twisted	13	4.21	1.86	0.157	0.73	0.78	B45-6559D
CIH, Gehl, MF, New Idea, Vicon	RH	Twisted	13	4.21	1.86	0.157	0.73	0.78	B45-6560D
Bush Hog, Hesston	RH	Twisted	13	4.76	1.88	0.165	0.89	0.78	B45-6563D
Bush Hog, Hesston	LH	Twisted	13	4.76	1.88	0.165	0.89	0.78	B45-6564D
Kuhn, Gehl, John Deere, NH	LH	Twisted	13	4.72	1.79	0.170	0.73	0.78	B45-6565D
Kuhn, Gehl, John Deere, NH	RH	Twisted	13	4.72	1.79	0.170	0.73	0.78	B45-6566D
Hesston, Kuhn, Gehl, John Deere, NH	RH	Twisted	13	4.21	1.78	0.169	0.72	0.80	B45-6568D
Hesston, Kuhn, Gehl, John Deere, NH	LH	Twisted	13	4.21	1.78	0.169	0.72	0.80	B45-6569D
CNH, Hesston	LH	Twisted	18	4.21	1.88	0.163	0.73	0.78	B45-6572D
CNH, Hesston	RH	Twisted	18	4.21	1.88	0.163	0.73	0.78	B45-6573D
CNH, Bush Hog, New Idea, MF	LH	Twisted	18	4.76	1.88	0.165	0.89	0.78	B45-6576D
CNH, Bush Hog, New Idea, MF	RH	Twisted	18	4.76	1.88	0.165	0.89	0.78	B45-6577D
CNH, Bush Hog, New Idea, MF	RH	Twisted	18	4.44	1.88	0.157	0.89	0.80	B45-6578D
CNH, Bush Hog, New Idea, MF	LH	Twisted	18	4.44	1.88	0.157	0.89	0.80	B45-6579D
Kuhn	Both	Flat	0	3.27	1.58	0.118	0.75	0.62	B45-6702D
Fella	LH	Twisted	13	3.86	1.86	0.160	0.75	0.83	B45-6703D
Fella	RH	Twisted	13	3.86	1.86	0.160	0.75	0.83	B45-6704D
CNH, New Holland	RH	Twisted	13	4.21	1.90	0.160	0.89	0.75	B45-6720D
CNH, New Holland	LH	Twisted	13	4.21	1.90	0.160	0.89	0.75	B45-6721D
Krone	LH	Twisted	13	4.41	1.90	0.166	0.75	0.76	B45-6722D
Krone	RH	Twisted	13	4.41	1.90	0.166	0.75	0.76	B45-6723D
CNH, Hesston	LH	Twisted	18	4.21	1.89	0.157	0.73	0.75	B45-6725D
CNH, Hesston	RH	Twisted	18	4.21	1.89	0.157	0.73	0.75	B45-6726D
M&W, Sitrex	LH	Twisted	13	3.88	1.75	0.145	0.80	0.78	B45-6737D
M&W, Sitrex	RH	Twisted	13	3.88	1.75	0.145	0.80	0.78	B45-6738D
Reese	LH	Twisted	13	3.99	1.88	0.157	0.80	0.80	B45-6741
Reese	RH	Twisted	13	3.99	1.88	0.157	0.80	0.80	B45-6742
									B45-6750
									B45-6751
Mortl	RH	Twisted	13	3.65	1.88	0.116	0.92	0.80	B45-6760D
Mortl	LH	Twisted	13	3.65	1.88	0.116	0.92	0.80	B45-6761D
Bush Hog, Beal, CIH, Fella, Gehl, Lely, MF, New Idea, Vicon,	LH	Twisted	13	4.72	1.86	0.163	0.73	0.78	B45-6992D
Bush Hog, Beal, CIH, Fella, Gehl, Lely, MF, New Idea, Vicon,	RH	Twisted	13	4.72	1.86	0.163	0.73	0.78	B45-6993D
Hesston, Kuhn, John Deere, NH	LH	Twisted	13	3.66	1.58	0.116	0.64	0.80	B45-6996D
Hesston, Kuhn, John Deere, NH	RH	Twisted	13	3.66	1.60	0.116	0.64	0.67	B45-6997D
Krone, Fahr, Fella, PZ Zweegers, Welger	Both	Flat	0	3.78	1.64	0.125	0.75	0.75	B45-6998D



B55-0340D



B55-0342D



B55-0344D



B55-0356D



B55-0357D



B55-0358D

### DISC MOWER BLADE BOLTS AND NUTS

6 bolts & 6 nuts per blister box

Replaces Number	Mfr. Name	Description / Application	Order No	List
561.501.00	Kuhn	For GMD41, 44, 55, 66, 240, 260, 452	B55-0340D	10.92
CC19334	John Deere	240, 260, 1320, 1326, 1327		
81160K	Vicon	Fits all models	B55-0342D	10.39
	Gehl	140, 160, 2310, 2330, 2350		
561.158.00	Kuhn	Heavy Duty, for CMD 500, 600, 801, FC250, 300, GMD66HD, GMD77HD	B55-0344D	19.11
527745K	New Idea	DM5406, 5407, 5408, 5409, 5410 5209, 5212, MC136	B55-0357D	21.98
1377.26.6	Krone	Includes 141.053.4 Bolt & 909.602.1 Nut	B55-0356D	19.93
BK001	Bush Hog	DM70, 80, 90, 180, 190	B55-0355D	40.27
527745K	Case/IH	3204, 3205, 3206, 3309		
	Hesston/MF	1006, 1007, 1306 - 1310, 1326 - 1330		
	New Idea	526, 527, 528, 5207, 5209		
CC19929K	John Deere	1320, 1326, 1327, 240, 260	B55-0358D	10.12
562.101.00	Kuhn	GMD44, 55, 66		
5621010015	New Holland	442, 452, 462		
87515925	New Holland	W/O Lifters. 615, 616, 617, 720HD, 750HD, 1409, 1410, 1411, 1412, 1431, 1432, 1441, 1442, 2331, 2332, 2353, 2355, 2358, DCX101, DCX131, DCX161, RDX161, H6730, H6740, H6750, H7220, H72230H H7320, H7330	B55-0359D	24.04
	1" Bolt			
8651926	New Holland	With Lifters. 615, 616, 617, 720HD, 750HD, 1409, 1410, 1411, 1412, 1431, 1432, 1441, 1442, 2331, 2332, 2353, 2355, 2358, DCX101, DCX131, DCX161, RDX161, H6730, H6740, H6750, H7220, H72230H H7320, H7330	B55-0360D	27.78







# DISC MOWER KNIVES

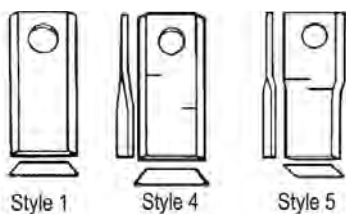

OEM Number	Application	Length Inches	Dia. Inches	Style	Shape	Bolt Order No	6 Blades Order No	List	25 Blades Order No	List
<b>NEW IDEA</b>										
527746	5209, 5212, 5312, 5406, 5407, 5408,	4.76	.890"	5	RH Twisted	B55-0355D	B45-6563D	10.51	B45-6563	41.18
527747	5409, 5410,	4.76	.890"	5	LH Twisted	B55-0355D	B45-6564D	10.51	B45-6564	41.18
526216	5209, 5212, 5406, 5407, 5408, 5409, 5410,	4.72	.728"	5	LH Twisted	B55-0357D	B45-6992D	11.07	B45-6992	41.74
526215	526, 527, 528	4.72	.728"	5	RH Twisted	B55-0357D	B45-6993D	11.07	B45-6993	41.74
	5070, 5512, 5515, 6070	4.21	.728	5	LH Twisted	B55-0342D	B45-6560D	9.39	B45-6560	37.96
		4.21	.728	5	RH Twisted	B55-0342D	B45-6559D	9.39	B45-6559	37.96
700712888		4.21	.717"	4	RH Twisted	B55-0344D	B45-6568D	9.83	B45-6568	39.24
700712889		4.21	.717"	4	LH Twisted	B55-0344D	B45-6569D	9.83	B45-6569	39.24
<b>POTTINGER</b>										
700.06.1650		3.78	.748"	1	Flat	N/A	B45-6998D	10.18	B45-6998	35.62
<b>PZ ZWEEGERS</b>										
DM155, DM303	230, 265, 275, 320	3.66	.640"	4	LH Twisted	B55-0358D	B45-6996D	10.18	B45-6996	30.57
DM160, DM304		3.66	.640"	4	RH Twisted	B55-0358D	B45-6997D	10.18	B45-6997	35.62
MT452S		3.78	.748"	1	Flat	N/A	B45-6998D	10.18	B45-6998	35.62
<b>REESE</b>										
		3.99	.80	5	LH Twisted	N/A			B45-6741	38.96
		3.99	.80	5	RH Twisted	N/A			B45-6742	38.96
<b>VERMEER</b>										
DM303	230, 275, 320	3.66	.640"	4	LH Twisted	B55-0358D	B45-6996D	10.18	B45-6996	30.57
DM304		3.66	.640"	4	RH Twisted	B55-0358D	B45-6997D	10.18	B45-6997	35.62
<b>VICON</b>										
902-58699	AM3200, CM165, CM167, CM240, CM247,	4.72	.728"	5	LH Twisted	B55-0357D	B45-6992D	11.07	B45-6992	41.74
902-58700	CM1700, KM240, KM241, KM281, KM321, CM2400, DMP2400, DMP3200, KM3200, KM4000, KMR3800, KMT3001	4.72	.728"	5	RH Twisted	B55-0357D	B45-6993D	11.07	B45-6993	41.74
902-61559	CM216, CM217, OM216, OM281, KM216,	4.21	.728"	5	LH Twisted	B55-0342D	B45-6559D	9.39	B45-6559	37.96
902-61560	KM281, KM391LP, GMR2800, CM2200, AM2800	4.21	.728"	5	RH Twisted	B55-0342D	B45-6560D	9.39	B45-6560	37.96
902-61559	CM2800, DMP2800, KM2800	4.21	.717"	4	RH Twisted	B55-0344D	B45-6568D	9.83	B45-6568	39.24
<b>WELGER</b>										
0982.15.06.00		3.78	.748"	1	Flat	N/A	B45-6998D	10.18	B45-6998	35.62
3208.01.03.44		3.78	.748"	1	Flat	N/A	B45-6998D	10.18	B45-6998	35.62

## ROTARY MOWER TAIL WHEELS

OEM Quality. Fits Most major Brands  
Including: Bush Hog, John Deere, LandPride, Rhino and More.

- Forged Yokes for added strength. • All parts zinc or powder coated.

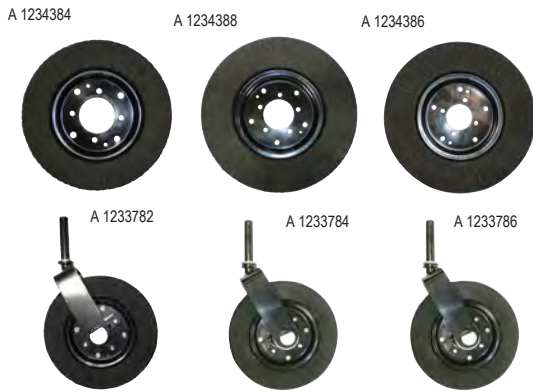

Description	Order No.	List
4x8 4 Bolt Rim w/15 x 4 Laminated Tire	A 1234384	46.55
6x9 4 Bolt Rim w/21 x 5.5 Laminated Tire	A 1234386	118.37
6x9 5 Bolt Rim w/21 x 5.5 Laminated Tire	A 1234388	118.37
Complete Tail Wheel Assembly. 4" x 8". 1-1/4" Diameter Yoke w/Cast Hub & Bushings	A 1233782	123.91
Complete Tail Wheel Assembly. 4" x 8". 1-1/4" Diameter Yoke w/Cast Hub & Bearings	A 1233784	145.56
Complete Tail Wheel Assembly. 6" x 9". 1-1/2" Diameter Yoke w/Cast Hub & Bearings	A 1233786	155.18

## ROTARY MOWER WHEEL PARTS

OEM Quality. Fits Most major Brands Including: Bush Hog, John Deere, LandPride, Rhino and More. All parts zinc or powder coated.



Type	Description	Used On	Order No.	List
Axle Bolt	3/4 x 8" Clipped Head Axle Bolt w/Castle Nut	A 1233782, A 1233784 & A 1233786	A 1234370	12.39
Bushing	3/4". For cast and fabricated hubs		A 1234377	5.82
Bushing	1". For cast and fabricated hubs		A 1234379	5.82
Hub	Cast Hub w/1" I.D. Bushings		A 1234371	20.69
Hub	Cast Hub w/3/4" I.D. Bushings	A 1233782	A 1234372	20.69
Hub	Cast Hub w/3/4" Bearings & Weed Guards. 510	A 1233784 & A 1233786	A 1234373	57.26
Hub	Fabricated Hub w/1" I.D. Bushings		A 1234374	19.97
Hub	Fabricated Hub w/3/4" I.D. Bushings.		A 1234375	19.97
Rebuild Kit	Includes 2 caps, 2 bearing/races, 2 step bushings and 2 seals		A 1234385	50.21
Yoke	1-1/2" Yoke diameter. For 3/4" axles		A 1234382	51.35
Yoke	1-1/4" Yoke diameter. For 3/4" axles		A 1234383	51.33

All Hubs Include Lug Bolts.

## FINISH MOWER PARTS

OEM Quality. Fits Most Major Brands.

Description	Order No.	List
3.25" x 10" Finish Mower Assembly 1" Diameter Yoke. 8.5" Long	A 1233781	106.82
Solid Molded Finish Mower Tire w/rim	A 1234378	62.47



## 25" LAMINATED WHEEL WITH TREAD PATTERN.

Laminated wheel was designed to take the place of the used foam filled aircraft tires on Rotary Mowers. It has been field tested 3,000+ hours. No foam to break down, no air to go flat. Takes the place of 21" laminated tires for increased height and it has a tread pattern for better traction.



WIDTH INCHES: 6.25"  
TIRE SIZE INCHES: 25" Diameter  
CAPACITY LBS: 2000  
HUB BOLT PATTERN: 5 on 5.5" centered  
CENTER HUB HOLE: 4" diameter  
TIRE DESIGN: Laminated with tread pattern  
WEIGHT LBS: 119 LBS each

Order No.	List
A 1234390	249.43

**5 PC. FINISH MOWER ASSEMBLY SPACERS**  
Includes (4) 1" and (1) 1/2" spacers.

Order No.	List
A 1234381	33.48

**3 PC. STEP DOWN BUSHING**  
3/4" x 1/2". Includes 2 bushings and 1 sleeve.

Order No.	List
A 1234369	10.56

## PTO SHAFT ASSEMBLIES - METRIC

### FLEX WING MOWERS

COMPLETE MAIN DRIVELINES W/CV JOINT\*

#### BUSH HOG® MODEL NO.: 2415, 2515, 2615, 2720 & 3615

Tractor Yoke	Clamp Yoke	Series	Replaces	Order No.	List
1 3/8" x 6 Spl.	1 3/4" x 20 Spl.	BYPY8	14516855	BP855620CV	778.17
1 3/8" x 21 Spl.	1 3/4" x 20 Spl.	BYPY8	14616855	BP8552120CV	778.17
1 3/4" x 20 Spl.	1 3/4" x 20 Spl.	BYPY8	14716855	BP8552020CV	778.17

OVERALL COMPRESSED LENGTH - 55"

#### RHINO® MODEL NO.: SR-15, SE-15

Tractor Yoke	Clamp Yoke	Series	Replaces	Order No.	List
1 3/8" x 6 Spl.	1 3/4" x 20 Spl.	BYPY8	14506851	BP851620CV	778.17
1 3/8" x 21 Spl.	1 3/4" x 20 Spl.	BYPY8	14606851	BP8512120CV	778.17
1 3/4" x 20 Spl.	1 3/4" x 20 Spl.	BYPY8	14706851	BP8512020CV	778.17

OVERALL COMPRESSED LENGTH - 51"

#### DEERE® MODEL NO.: 1517, 1518, 2018

Tractor Yoke	Clamp Yoke	Series	Replaces	Order No.	List
1 3/8" x 6 Spl.	1 3/4" x 20 Spl.	BYPY8	14516855	BP855620CV	778.17
1 3/8" x 21 Spl.	1 3/4" x 20 Spl.	BYPY8	14616855	BP8552120CV	778.17
1 3/4" x 20 Spl.	1 3/4" x 20 Spl.	BYPY8	14716855	BP8552020CV	778.17

OVERALL COMPRESSED LENGTH - 55"

### FLEX WING MOWERS

COMPLETE WING DRIVELINES W/FRICTION CLUTCH\*

#### BUSH HOG®

Yoke	Clutch Yoke	OAL		Replaces #	Order No.	List
		Compressed				
1-3/8X6 SPL.	1-3/4X20 SPL.	64.11		14106660	BP661620C	519.93
1-3/4X20 SPL.	1-3/4X20 SPL.	63.18		14106661	BP6632020C	521.97
1-3/8X6 SPL.	1-3/8X21 SPL.	61.15		14116660	BP661621C	519.93

#### BUSH HOG®, JOHN DEERE AND SCHULTE

Yoke	Clutch Yoke	OAL		Replaces #	Order No.	List
		Compressed				
1-3/4X20 SPL.	1-3/4X20 SPL.	64.11		14106664	BP6642020C	622.07

#### BUSHWHACKER

Yoke	Clutch Yoke	OAL		Replaces #	Order No.	List
		Compressed				
1-3/4X20 SPL.	1-3/8X6 SPL.	64.11		14126664	BP664206C	617.02

#### JOHN DEERE, SCHULTE

Yoke	Clutch Yoke	OAL		Replaces #	Order No.	List
		Compressed				
1 3/8X21 SPL.	1 3/8X21 SPL.	64.11		14116664	BP6642121C	613.39

#### M&W, RHINO, LANDPRIDE AND WOODS

Yoke	Clutch Yoke	OAL		Replaces #	Order No.	List
		Compressed				
1-3/4X20 SPL.	1-3/4X20 SPL.	56.11		14106656	BP6562020C	597.01

### ALL PURPOSE

TRACTOR YOKE	IMPLEMENT YOKE	OAL COMPRESSED	REPLACES	SERIES	ORDER NO	List
1-3/8X6 SPL. QD	1-3/8X6 SPL. QD	37"	14006137	BYPY1	BP13766	105.32
1-3/8X6 SPL. QD	1-3/8X6 SPL. QD	47"	14006247	BYPY2	BP24766	138.76
1-3/8X6 SPL. QD	1-3/8X6 SPL. QD	48"	14006448	BYPY4	BP44866	154.06
1-3/8X6 SPL. QD	1-3/8X6 SPL. QD	55"	14006455	BYPY4	BP45566	167.92
1-3/8X6 SPL. QD	1-3/8X6 SPL. QD	43"	14006543	BYPY5	BP54366	182.97
1-3/8X6 SPL. QD	1-3/8X6 SPL. QD	55"	14006555	BYPY5	BP55566	198.70
1-3/8X6 SPL. QD	1-3/8X6 SPL. QD	44"	14006644	BYPY6	BP64466	193.03
1-3/8X21 SPL. QD	1-3/8X21 SPL. QD	44"	14066644	BYPY6	BP6442121	204.58
1-3/8X6 SPL. QD	1-3/8X6 SPL. QD	55"	14006655	BYPY6	BP65566	218.16
1-3/8X6 SPL. QD	1-3/8X6 SPL. QD	57"	14006657	BYPY6	BP65766	226.04
1-3/8X21 SPL. QD	1-3/8 ROUND W/PINHOLE	66"	14016666	BYPY6	BP66621R	251.66
1-3/8X6 SPL. QD	1-3/8X6 SPL. QD	46"	14006846	BYPY8	BP84666	282.51
1-3/8X21 SPL. QD	1-3/8X21 SPL. QD	46"	14066846	BYPY8	BP8462121C	282.51
1-3/8X6 SPL. QD	1-3/8X6 SPL. QD	57"	14006857	BYPY8	BP85766	279.31

### DISC MOWER

TRACTOR YOKE	IMPLEMENT YOKE	OAL COMPRESSED	REPLACES	SERIES	ORDER NO	List
1-3/8X6 SPL. QD	1-3/8X6 SPL. W/OVERRUNNING CLUTCH	39"	14306639	BYPY6	BP63966C	276.99

### FERTILIZER SPREADER

TRACTOR YOKE	IMPLEMENT YOKE	OAL COMPRESSED	REPLACES	SERIES	ORDER NO	List
1-3/8X6 SPL. QD	1-3/8X6 SPL. QD	27"	14006127	BYPY1	BP12766	87.54

### FINISHING MOWER

TRACTOR YOKE	IMPLEMENT YOKE	OAL COMPRESSED	REPLACES	SERIES	ORDER NO	List
1-3/8X6 SPL. QD	1-3/8X6 SPL. QD	37"	14006637	BYPY6	BP63766	182.02

### ROTARY CUTTER

TRACTOR YOKE	IMPLEMENT YOKE	OAL COMPRESSED	REPLACES	SERIES	ORDER NO	List
1-3/8X6 SPL. QD	1-3/8 ROUND W/PINHOLE	36"	14006436	BYPY4	BP4366R	141.10
1-3/8X6 SPL. QD	1-3/8X6 SPL. QD	46"	14006546	BYPY5	BP54666	264.58
1-3/8X6 SPL. QD	1-3/8 ROUND W/PINHOLE	42"	14006442	BYPY4	BP4426R	139.15
1-3/8X6 SPL. QD	1-3/8 ROUND W/PINHOLE	52"	14006542	BYPY5	BP55266	176.94
1-3/8X6 SPL. QD	1-3/8 ROUND W/PINHOLE	52"	14006652	BYPY6	BP6526R	212.47
1-3/8X6 SPL. QD	1 3/8 x 6 Spl. W/FRICTION CLUTCH	54"	14106654	BYPY6	BP65466C	308.18
1-3/8X6 SPL. QD	1-3/8 ROUND W/PINHOLE	52"	14006451	BYPY4	BP4526R	159.87
1-3/8X6 SPL. QD	1 3/8 x 6 Spl. W/FRICTION CLUTCH	38"	14106438	BYPY4	BP43866C	232.09
1-3/8X6 SPL. QD	1 3/8 x 6 Spl. W/FRICTION CLUTCH	46"	14106546	BYPY5	BP54666C	281.76

## Exclusive Factory Testing For Maximum Field Performance!

- **SHOT PEEN TESTED:** To Reduce Stress In The Blade And Increase Flexibility.
- **CHARPY TESTED:** An Impact Test To Reduce Breakage
- **STEEL CHEMISTRY TESTED:** The Chemistry For The Steel In Our Blades Is Not Only Tested Once, But Twice To Ensure Only The Best Steel Is Used.
- Painted Black For Maximum Shelf Appeal
- Manufactured From High Quality 5160 High Carbon Steel
- OEM Quality



BUSH HOG									
Replaces	Blade Rotation	Application	Length	Overall Width	Blade ness	Thick-Size	Hole Bolt Used	Order No.	List
7555	CCW	1126 LH, 1226 LH, 1310 RH, 2315 RH, 2415 RH, 2615 RH etc.	24-3/4	4	1/2	1-1/2	B55-0336	HA7555	41.75
7556	CCW	1310, 1315, 2315, 2415, 2615, 3615, 1206, 1256, 2720, 3610, 12610, 12615 ETC.	27-3/4	4	1/2	1-1/2	B55-0336	HA7556	43.76
7557	CCW	207, 220, 257, 307, 2620, 277, 1220, 1257, 1287, 1307, 2620 ETC.	30-3/4	4	1/2	1-1/2	B55-0336	HA7557	47.96
11150	CW	126, 315, 1126, 1226, 1315, 2615, 3615, 2315, 2415, 2510, 2610, 3610, 12610, 12615 ETC.	24-3/4	4	1/2	1-1/2	B55-0336	HA11150	37.93
78495	CCW	3126-R&O, 3126S-O, 3210, 13126R, 13126S. 2 USED ON 13126. 4 ON 3126-O	24	4	1/2	1-1/2	B55-0336	HA78495	31.90
78494	CW	316S, 1312R, 3126R, 3210, 13126S, 2710, 3125 2715 2 USED ON	24	4	1/2	1-1/2	B55-0336	HA78494	31.90
86665	CCW	2 used on 3008, 3368, 3368S. 4 ON 13368.3214, 113368	20-3/4	4	1/2	1-1/2	B55-0336	HA86665	27.93
86666	DUAL EDGE	3368, 3368S, 13368	20	4	1/2	1-1/2	B55-0336	HA86666	26.89

JOHN DEERE									
Replaces	Blade Rotation	Application	Length	Overall Width	Blade ness	Thick-Size	Hole Bolt Used	Order No.	List
W494170	CW	HX10, HX20, HX15, CX15 CX20	21-1/2	3	1/2	1-1/2	B55-0360	HAW45326	29.49
W49171	CCW	HX20 MX15, HX1,5 CX15, CX20, HX10, MX10	21-1/2	3	1/2	1-1/2	B55-0360	HAW45327	29.49
W43466	CCW	509, 609, 709, 727, 737, 1008, 1508, 1517, 1518, 2018	21-3/4	4	1/2	1-1/2	B55-0353	B45-5030	30.79
W43465	CW	727, 737, 1008, 1018, 1508, 1517, 1518, 2018	21-3/4	4	1/2	1-1/2	B55-0353	B45-5031	30.79
W48578	CW	RH CX20, HX20	28-1/4	4	1/2	1-1/2	B55-0360	HA48578	36.67
W48577	CCW	LH & CENTER CX20, HX20, MX5, MX6, MX7,	28-1/4	4	1/2	1-1/2	B55-0360	HA48577	36.67

LAND PRIDE									
Replaces	Blade Rotation	Application	Length	Overall Width	Blade ness	Thick-Size	Hole Bolt Used	Order No.	List
820169C	CCW	RCB6015, RC(M)5010, 5015, 6010, 6015	23	4	1/2	1-1/2	B55-0348	HA820169C	42.87
820170C	CW	RCB6015, RC(M)5015, 6015	23	4	1/2	1-1/2	B55-0348	HA820170C	32.63
820168C	CCW	RCB6015, RC(M)5010	29	4	1/2	1-1/2	B55-0348	HA820168C	47.10

RHINO									
Replaces	Blade Rotation	Application	Length	Overall Width	Blade ness	Thick-Size	Hole Bolt Used	Order No.	List
8589	CCW	A960, SE15, TW60, SR60 BEFORE S/N10145,	20-1/8	4	1/2	1-1/2	B55-0358	HA8589	39.11
8590	CW	SE15, SR15, SR15M BEFORE S/N13831, TW120	20-1/8	4	1/2	1-1/2	B55-0358	HA8590	29.82
8588	CCW	SE15, TW72, SR72	26-1/4	4	1/2	1-1/2	B55-0358	HA8588	37.02
058201, 0330P	CCW	15, 1008, CY72, FL10M, FL15M, SA15, SR15MR	27-1/2	4	1/2	1-3/8	B55-0332	HA582013F	35.45
0652010330	CW	15 1008, CY60, SA15	25	4	1/2	1-3/8	B55-0332	HA652011RF	33.76
0622010330	CCW	15 1008, CY60, SA15	25	4	1/2	1-3/8	B55-0332	HA622013F	43.85

SCHULTE									
Replaces	Blade Rotation	Application	Length	Overall Width	Blade ness	Thick-Size	Hole Bolt Used	Order No.	List
401028	CCW	5026 CENTER, 5026RH INNER, V1280RH	27-3/4	4	1/2	1-1/2	B55-0361	HA401028	46.13
401032	CW	5026LH Inner, center for others	27-3/4	4	1/2	1-1/2	B55-0361	HA401032	46.13
401026	CW	5026LH, OUTER, S100LH.S100RH, S150LH, XH1000LH, XH1000RH, XH1500LH	24-3/4	4	1/2	1-1/2	B55-0361	HA401026	36.82
401027	CCW	5026RH, OUTER, S100LH.S100RH, S150RH, XH1000LH, XH1000RH, XH1500RH	24-3/4	4	1/2	1-1/2	B55-0361	HA401027	36.82

WOODS									
Replaces	Blade Rotation	Application	Length	Overall Width	Blade ness	Thick-Size	Hole Bolt Used	Order No.	List
19161	CW	2120, 2162, 3180, 3240	25-1/4	4	1/2	1-1/2	B55-0362	HA19161	33.92
19160	CCW	2120, 2162, 3180, 3240	25-1/4	4	1/2	1-1/2	B55-0362	HA19160	42.41



## ROTARY BLADE BOLTS

Description	Replaces Number	Application	Thread Specification	Order No.	List
Bolt Kit	7919, HL418, TK#735900	Bush Hog 6, 12, 105, 109, 126, 160, 205, 206, 226, 305, 306, 307, 310, 315, 502, 600, 1109, 1126, 1209, 1226, 1310, 1315, 1600 also fits some International, King Kutter, Big Bee, Marvel 4', 5', 6', 7', HICO 4', 5', 6'	1-1/8 12 UNF	B55-0336	24.17
Bolt Kit	802-277C, 41-052-0005, 12-180, 1-219, 6T1022	Great Plains, KMC, Mohawk, Tiger	1-1/8 12 UNF	B55-0348	18.49
Bolt Kit	HL418N	Howse New style bolt w/square shoulder	1-1/8 12 UNF	B55-0350	8.51
Bolt Kit	W22237	JD 509, 609, 709, 1508	1-1/8 12 UNF w/stake key	B55-0353	17.97
Bolt Only	W38054	JD XH, MX, CX, XLX series. 506, 606, 613, 616, 717, 1517	1 14 UNF	B55-0360	8.51
Bolt & Nut	57-104-4 Nut #5 GL-16-140	Servis Rhino Cyclone 60, 72, 84, 128, Flex 15, Gyro 60, 72, 84, 128, 160, 1310	1 14 UNF LH	B55-0332	22.49
Bolt Only	251-0007	Schulte 5026, 5100, 5150, V1280, XH1000, XH1500	1-1/8 UNF	B55-0361	14.45
Bolt Only	8227	Terrain King AG84B, A101V, A151V,	1 14 UNF RH	B55-0358	20.55
Bolt Kit	15331, 809981	Woods, Taylor, MF w/3/8 thick blades Late Hydro 10, 15	1-1/8 12 UNF	B55-0359	7.39
Bolt Only	32616	Woods 2120, 2162, 3180, 3240	Bolt has groove for a pin clamp assembly	B55-0362	17.47

## EASY RICER CUTTERBAR KITS & PARTS

Replaces Number	Size	Description	Application	Order No	List
ERLS2-14S	2'	2' Lower Segment (Bolt-On)14 Serr.	All Easy Ricer Applications	S35-3013	<b>83.89</b>
ERLS2	2'	2' Lower Segment (Bolt-On), Super 7	All Easy Ricer Applications	S35-3524	<b>110.95</b>
MC468		Wear Plate	All Easy Ricer Applications	P44-0417	<b>2.53</b>
		Adjustable Clip-Lo Arch	All Easy Ricer Applications	C45-0041	<b>10.71</b>
2TC-14S	25/Box	XHTS Miniature Section. 2". 1-1/4" Hole Spacing. 2-3/4" Long. With Slot. Bottom Countersunk		S20-3404P	<b>29.03</b>
2TC	25/Box	XH7TS-Miniature Section. 2". 1-1/4" Hole Spacing. 2-3/4" Long. With Slot. Bottom Countersunk.	All Easy Ricer Kits Lower Seg.	S20-3521P	<b>29.03</b>
SSL192D	10/Box	XH7 TS-Rice Section. No Slot	All Easy Ricers Except Mac Don	S20-3370	<b>14.66</b>
L192DCR	10/Box	XH TS CR Section. No Slot		S20-4608	<b>18.01</b>
0922CB	10/Box	XH TS Section. No Slot		S20-3364	<b>17.64</b>
H300	10/Box	XHTS Section. 3" x 2-3/4". No Slot		S20-3405	<b>17.98</b>
9/16 CSZP	1#	9/16" Rivet, 1 lb./BB	All	R36-0469D	<b>11.29</b>



- Simple bolt-on conversion
- Time and money savings
- Faster ground speed, especially in down and tangled rice.

Easy Ricer packages are complete cutterbar conversion kits. Kits include: Full length riveted sickle (less drive head) with black 14-tooth sections, lower segments (to replace guards), adjustable hold down clips, wear plates, and hardware.

## COMBINE TEETH



**COMBINE PICKUP REEL**  
For Combines and Pickup reels. Replaces H1611. Steel. 100 per box. MFR: Hume

<b>Order No.</b>	<b>List</b>
T16-0124	1.60



**4.5" NYLON FLEX TINE**  
Replaces N66A. 1 mounts to front of wood bat. 100 per box.

<b>Order No.</b>	<b>List</b>
T16-0183	189.12



**4.5" NYLON FLEX TINE**  
Replaces H127035, 71345318, 27631J6M1, 197058C, 786031. 1 mounts to rear of tear drop steel bat. 100 per box.

<b>Order No.</b>	<b>List</b>
T16-0767	165.82



**2 PIECE M/L REEL TINE**  
Replaces 782551, 1989438C1, AH136689, AH153175. 100 per box. With clamps and screws for 4.5" spacing.

<b>Order No.</b>	<b>List</b>
T16-0720	175.64



**2 PIECE M/L REEL TINE**  
Replaces 782226, 1989438C1, AH136689, AH153175. 10 per bag. With clamps and screws for 4.5" spacing.

<b>Order No.</b>	<b>List</b>
T16-0715	19.03



**4.5" M/L REEL TINE**  
For T16-0715 and T16-0720. No clamps. Replaces HA100MLT. 100 per box.

<b>Order No.</b>	<b>List</b>
T16-0725	128.83

**REPLACEMENT SCREW**  
For T16-0715 and T16-0720. No clamps. Replaces HA20SC. 20 per box.

<b>Order No.</b>	<b>List</b>
B55-0096D	2.40

## TIGER JAW® SPLICED SICKLES - DOUBLE DRIVE (LESS HEAD) - 1.5" SYSTEMS - ALSO FITS NH 1.5" SYSTEMS

Bolted Super 7

OEM Number	Section Number	H7TSCR No. Of Sections	Size	Segments				2.5' Ext. Seg.	5' Ext. Seg.	Complete Sickle Order No	List
				5'LH Head Seg. S35-2507	5'LH Overlap Seg. S35-2508	5'RH Head Seg. S35-2509	5'RH Overlap Seg. S35-2510				
9842587	SSTJ6700	50	25'LH	1	1	-	-	1	-	S35-2503	387.41
9820457	SSTJ6700	58	30'RH	-	-	1	1	-	1	S35-2506	373.94

Use H15-0060 LH Head, H15-0061 RH Head if needed. (For Tiger Jaw applications only.) Use H15-0752 Head if needed. (For OEM 1.5" Systems only.)

## TIGER JAW® REPLACEMENT SICKLES - Bolted with Super 7 Sections

Replaces Number	Size	Application	Order No	List	Replaces Number	Size	Application	Order No	List
1-Piece Universal with Super 7 sections					Spliced Universal with Super 7 sections				
TJ4-U2000	4'	All TJ Kits - Less Head	S35-2860	82.03	TJ4-U2000	4'	All TJ Kits - Less Head	S35-2860	82.03
TJ5-U2000	5'	w/2" Hole Spacing	S35-2276	105.95	TJ5-U2000	5'	w/2" Hole Spacing	S35-2276	105.95
TJS16-U2000	16'	In Knife Back	S35-2153	349.16	TJ8-U2000	8'	In Knife Back	S35-2861	140.22
TJS20-U2000	20'		S35-2155	427.33	TJ8.5-U2000	8.5'	Head Segment	S35-2862	141.11
TJ4-U2116	4'	All TJ Kits - Less Head	S35-2271	82.03	TJ4-U2116	4'	All TJ Kits - Less Head	S35-2271	82.03
TJ5-U2116	5'	w/2-1/16" Hole Spacing	S35-2277	112.09	TJ5-U2116	5'	w/2-1/16" Hole Spacing	S35-2277	112.09
TJS16-U2116	16'	In Knife Back	S35-2154	349.04	TJ8-U2116	8'	In Knife Back	S35-2858	137.50
TJS20-U2116	20'		S35-2156	423.03	TJ8.5-U2116	8.5'	Head Segment	S35-2859	141.11



For both the original Tiger Jaws and Tiger Jaws 2000 series.

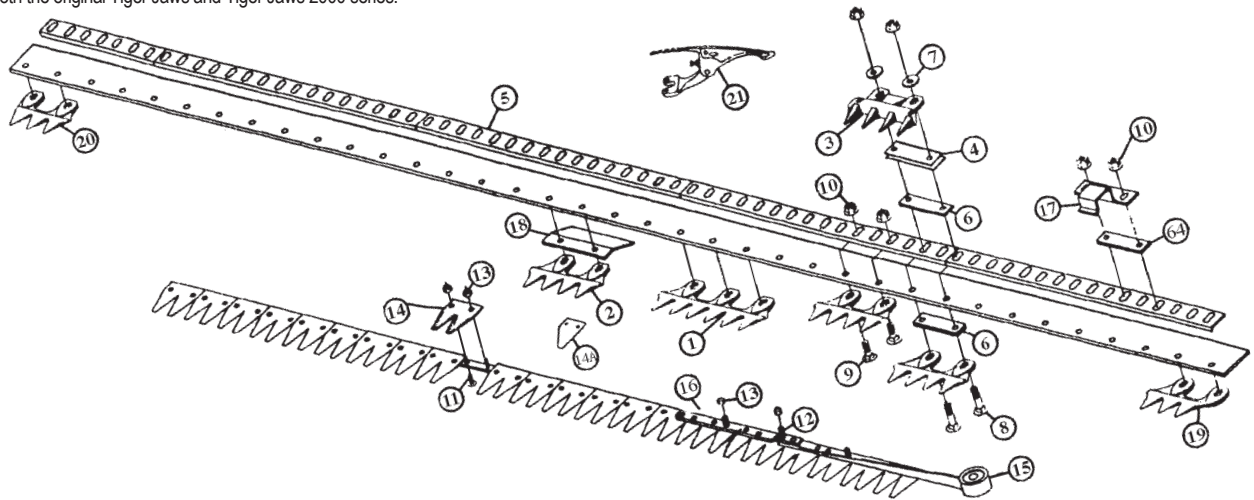

Key Code Number	OEM Number	Description	Pkg Qty	Order No	List
1	TJ44 - 6A	Guard, 6 Point All Except IHC 1020	Each	G81-0446	46.42
1	TJ66-6W	Guard, 6 Point Wide Slot IHC 1020 Only	Each	G81-0788	97.30
2	TJ44 - 4A	Guard, 4 Point All Except IHC 1020	Each	G81-0581	20.67
2	TJ66-4	Guard, 4 Point IHC 1020 Only	Each	G81-0826	17.38
NI	N/A	Clip Kit, Adjustable, 3/8" Hardware (New Style). Lock Nut	Each	C45-0003	15.42
NI	N/A	Clip Kit, Adjustable, 7/16" Hardware (New Style)	Each	C45-0004	14.24
NI	N/A	Clip Adjuster, 2 Used per Clip (New Style)	Each	C45-0001	2.83
NI	N/A	Clip, Steel, Adjustable Hold Down (New Style)	Each	C45-0002	9.18
5	FLW24HT	2 Ft. Wear Plate, Heat Treated	Each	P44-0200	15.14
5	TJ11WP	Wear Plate, 1 Foot, Heat Treated, IHC 1020 Only	Each	P44-0660	10.14
7	TJ45K	Retainer, 7/16"; not required w/TJ2000	10/Bag	R34-0154	18.85
8	TJ214SBN	Carriage Bolt, Special 3/8" x 2-1/4" w/7/16" Head w/Nut - JD	25/Bag	B55-0203	33.60
8	TJ200BN	Carriage Bolt, 7/16" x 2" W/Nut - Case-IH, H-C, NH, JE Love, AC, MF	25/Bag	B55-0200	29.71
11	TJ55BN50	Section Bolt & Nut, 5/8"	50/BB	B55-0065D	9.55
12	TJ85BN	Head Bolt & Nut, 1"	15/BB	B55-0085D	5.85
12	TJ95BN	Head Bolt & Nut, 1 - 1/4"	12/BB	B55-0095D	6.02
14	SSTJ6700	Section, Universal, Fits 2" & 2-1/16" Hole Spacing - Super Seven	10/BB	S20-4409	16.71
14	SSTJ6000	Section, 2" Hole Spacing - Super Seven	10/BB	S20-4316	17.62
14	TJ6000	Section, 2" Hole Spacing	10/BB	S20-4638	26.71
14	SSTJ7000	Section, 2-1/16" Hole Spacing - Super Seven	10/BB	S20-4317	17.62
14	TJ7000	Section, 2-1/16" Hole Spacing	10/BB	S20-4639	17.63
14A	TJ1200	Half Section	10/BB	S20-0297	21.74
15	71358960	Sickle Head AC Series 3 & 300	Each	H15-0228	102.79
15	180859C91	Sickle Head, (AC, IH, MR) w/Hart Carter Gen III Floating Cutterbar	Each	H15-0194	118.02
15	AH89498	Sickle Head, John Deere 900 Series After 1996	Each	H15-0004	95.77
16	TJ122KR	Reinforcement Strap 2" Hole Spacing	Each	S78-0052	13.87
17	BSH500	High Arch Hold Down	Each	C45-0693	4.79
18	TJ6SS	Skid Shoe, IHC 820 Only	Each	S31-0999	5.02
NI*		IH 820 Head	Each	H15-0640	256.00
NI*		IH 810 Head (not floating)	Each	H15-0294	108.93
NI*		810 Flex Head	Each	H15-0194	118.02

NI\* - Not Illustrated N/A - Not Applicable

## SPLICE KITS

Description	Order No	List
Splice Kit w/bolts & nuts, 2" Spacing	C83-0750	22.80
Splice Kit w/bolts & nuts, 2-1/16" Spacing	C83-0755	22.80
Bolt & Nut Kit for Spliced Sickles, 12/BB	B55-0049D	8.74

<b>A</b>	
Air Seeder Spoons .....	174
Alabama Sweeps .....	175
Alfalfa Spikes .....	177
Ammonia Knives .....	182
Anhydrous Knives .....	182
Application Charts, Tillage .....	142 - 143

<b>B</b>	
Bearing, Disc .....	159 - 162
Bearing, Drill Disc .....	159
Bearings, Gauge Wheel .....	164
Blades, Disc .....	154 - 155
Blades, Drill Disc .....	185
Blades, Harrow .....	154 - 155
Blades, Peanut .....	175
Bolts, Plow .....	148
Bubble Coulters .....	153

<b>C</b>	
Caps, Ripper .....	179
Caps, Subsoiler .....	179
Chain, Covering .....	183
Chisel Plow Sweeps .....	176, 177
Chisel Points .....	177 - 178
Chisel Sweeps .....	176, 177
Chrome Plated Plow Bolts .....	148
Clipped Head Bolt .....	148
Clips, Hammer Lock .....	148, 174
Concave Coulters .....	153
Cone Style Disc Blades .....	155
Conservation Points .....	179
Cotton Stalk Puller Blade .....	156
Coulters .....	153, 155
Covering Chain .....	183
Crescent Hoes .....	178
Cultivator Gauge Tires .....	164
Cultivator Gauge Wheel Bearings .....	164
Cut Out Disc Blades .....	154 - 155

<b>D</b>	
Danish Bolts .....	148
Danish Sweeps .....	176
Danish Tine Clamps .....	176
Danish Tines .....	176
Disc Axles .....	163
Disc Bearings .....	159 - 162
Disc Blade Application Charts .....	142
Disc Blade Terminology .....	141
Disc Blade Warranty Policy .....	141
Disc Blades .....	154 - 155
Disc Blades, Cone Style .....	155
Disc Blades, Flat Center .....	155
Disc Blades, Special Concavity .....	156
Disc Replacement Parts .....	163
Double Disc Openers .....	183 - 184
Drill Disc Assemblies .....	183 - 184
Drill Disc Bearings .....	185
Drill Disc Blades .....	184
Drill Disc Parts .....	184 - 185
Drill Points .....	183
Dust Caps, Drill Disc .....	185
Dust Caps, Grain Drill .....	185

<b>E</b>	
Elliptical Head Bolts .....	148

<b>F</b>	
Fertilizer Knives .....	182
Fertilizer Tubes .....	182
Ferobide .....	180
Field Cultivator Sweeps .....	173
Flat Center Disc Blades .....	155
Flat Coulters .....	153
Flat Center Disc Blades .....	155
Flo-Rite® .....	170 - 171
Fluted Coulters .....	153
Furrowers .....	174

<b>G</b>	
Gauge Wheel Bearings .....	164
Gauge Wheel Halves .....	164
Gauge Wheel Tires .....	164

<b>G continued</b>	
Gauge Wheels .....	164
Grain Drill Covering Chains .....	183
Grain Drill Disc Assemblies .....	183 - 184
Grain Drill Parts .....	185
Grain Drill Points .....	182
Graphite .....	172
Grass Knife, NH3 .....	182
Ground Hog Knife .....	182

<b>H</b>	
Hammer-Lock Sweeps .....	174
Hardware .....	148
Hardware, Drill Disc .....	185
Harrow Blades .....	159 - 162
Harrow Shoes .....	181
Harrow Tines .....	181
Hoes, Crescent .....	178
Hoes, Tender Plant .....	178
Hoes, Vegetable .....	178

<b>J</b>	
Joyce Sweeps .....	175

<b>K</b>	
Knives, Ammonia .....	182
Knives, Anhydrous .....	182
Knives, Fertilizer .....	182
Knock On Sweeps .....	174

<b>L</b>	
Landsides .....	150
Lister Shares .....	174
Lister Style Furrowers .....	174

<b>M</b>	
Modular Knife, NH3 .....	182
Moldboard Plow Parts .....	149
Moldboard Plow Information .....	138 - 139
Moldboards, Chisel Plow .....	178
Moldboards, Plow .....	149
Mounting Clips, Hammer-Lock .....	148, 174

<b>N</b>	
Neoprene Tubes .....	182
NH3 Knife .....	182
Noble Sweeps .....	175
Notched Edge Disc Blades .....	154 - 155, 156

<b>P</b>	
Peanut Blades .....	175
Planter Gauge Wheel Bearings .....	164
Planter Gauge Wheel Tires .....	164
Planter Gauge Wheels .....	164
Plow Bolts .....	148
Plow Coulters .....	153, 155
Plow Landsides .....	150
Plow Moldboards .....	149
Plow Parts, Moldboard .....	149
Plow Shares .....	150 - 152
Plow Shins .....	149
Plow Wear Pads .....	150
Points, Chisel .....	177 - 178
Points, Drill .....	183
Points, Ripper .....	179
Points, Slash .....	178
Points, Spring Tooth .....	177
Points, Subsoiler .....	179
Points, Wing Sweep .....	175
Poly Shank Savers .....	178
Press Wheel Tires .....	164
Protective Coating Spray .....	148

<b>R</b>	
Ripper Caps .....	179
Ripper Points .....	179
Rippled Coulters .....	153
Row Crop Sweeps .....	173

<b>S</b>	
S-Tine Clamps .....	176
S-Tines .....	176
Seals, Drill Disc .....	185
Seed Disc Openers .....	183 - 184
Seed Openers .....	183 - 184
Seed Tubes .....	185

<b>S Continued</b>	
Shank Savers .....	148
Shares, Lister .....	174
Shares, Plow .....	150 - 152
Shares, Ribbed .....	150 - 152
Shares, Upset Forged .....	152
Shares, Wing .....	175
Shims, Drill Disc .....	185
Shins .....	149
Shoes, Harrow .....	181
Single Disc Openers .....	184
Slash Points .....	178
Smooth Edge Disc Blades .....	154 - 158
Spacers, Drill Disc .....	185
Special Concavity Disc Blades .....	156
Special Plow Bolts .....	148
Spikes, Alfalfa .....	177
Spikes, Swedged .....	178
Spoons, Air Seeder .....	174
Spring Tooth Points .....	177
Spring Tooth Sweeps .....	177
Steels, Cultivator .....	178
Stem Angles .....	144 - 147
Subsoiler Caps .....	179
Subsoiler Coulters .....	153, 155
Subsoiler Points .....	179
Swedged Spikes .....	178
Sweep Application Charts .....	143
Sweep Terminology .....	141
Sweeps, Alabama .....	175
Sweeps, Chisel .....	176, 177
Sweeps, Chisel Plow .....	176, 177
Sweeps, Danish .....	176
Sweeps, Field Cultivator .....	173
Sweeps, Hammer-Lock .....	174
Sweeps, Joyce .....	175
Sweeps, Knock-On .....	174
Sweeps, Noble .....	175
Sweeps, Row Crop .....	173
Sweeps, Spring Tooth .....	177
Sweeps, Terminator .....	174
Sweeps, Wheatland .....	176, 177
Sweeps, Wing .....	175

<b>T</b>	
Talc Powder .....	172
Technical Information .....	129 - 141
Tender Plant Hoes .....	178
Terminator Sweeps .....	141
Terminology, Disc Blades .....	141
Terminology, Moldboard Plow .....	129, 138 - 139
Terminology, Plow .....	133 - 137
Terminology, Sweeps .....	141
Tines, Danish .....	176
Tires, Gauge Wheel .....	164
Trash Shields, Drill Disc .....	185
Trash Shields, Grain Drill .....	185
Tubes, Fertilizer .....	185
Tubes, Neoprene .....	185
Tubes, Seed .....	185

<b>V</b>	
V-Sweeps .....	175
Vertical Tillage .....	157

<b>W</b>	
Warranty Policy, Disc Blade .....	141
Washers, Drill Disc .....	185
Wavy Coulters .....	153
Wear Pads .....	150
Wheatland Sweeps .....	176, 177
Wheel Halves, Gauge .....	164
Wheels, Gauge .....	164
Wing Shares .....	175
Wing Sweep Points .....	175
Wing Sweeps .....	175

# Moldboard Plow Information

## Moldboard Plow

The primary purpose of the moldboard plow is to completely turn the soil to a depth of from 8 to 14 inches. This places the residue which was on top of the soil either under the soil or mixed with the soil.

There are two basic types of moldboard plows:

- 1) One way moldboard plow — the original and still most popular plow. Soil is always turned to the right hand side.
- 2) Two way or rollover plow — has two sets of bottoms;  $\frac{1}{2}$  being right hand and the other  $\frac{1}{2}$  being left hand.

All moldboard plows have three parts in common. The frame, the beam, and the frog. The beam attaches to the frame of the plow and the frog attaches to the beam. The frog and its attached components, the share, shin, landside and moldboard, is the part that engages the soil.

## Moldboard Plow Terms

**Deep Suck** — Penetration point of the plow share that enables the share to "pull" itself into the soil.

**Flat-Blade Type Share** — Has no deep suck penetration point.

**Full Cut Share** — Cutting edge extends outwards at both ends of plow share to cut full width that share was designed for.

**Narrow Cut Share** — Back, or rear cutting edge of plow share cut off "shorter" to cut less than full cut plow was designed for.

**Shin** — A replaceable extension for the front of the moldboard where the most wear is encountered.

**Landside** — Heavy steel or cast iron plate bolted to the frog assembly to counteract the natural tendency of the plow to constantly run into the land.

**Wear Pad** — A piece of steel bolted to the landside wear face that can be reversed and then replaced at less cost than the entire landside assembly.

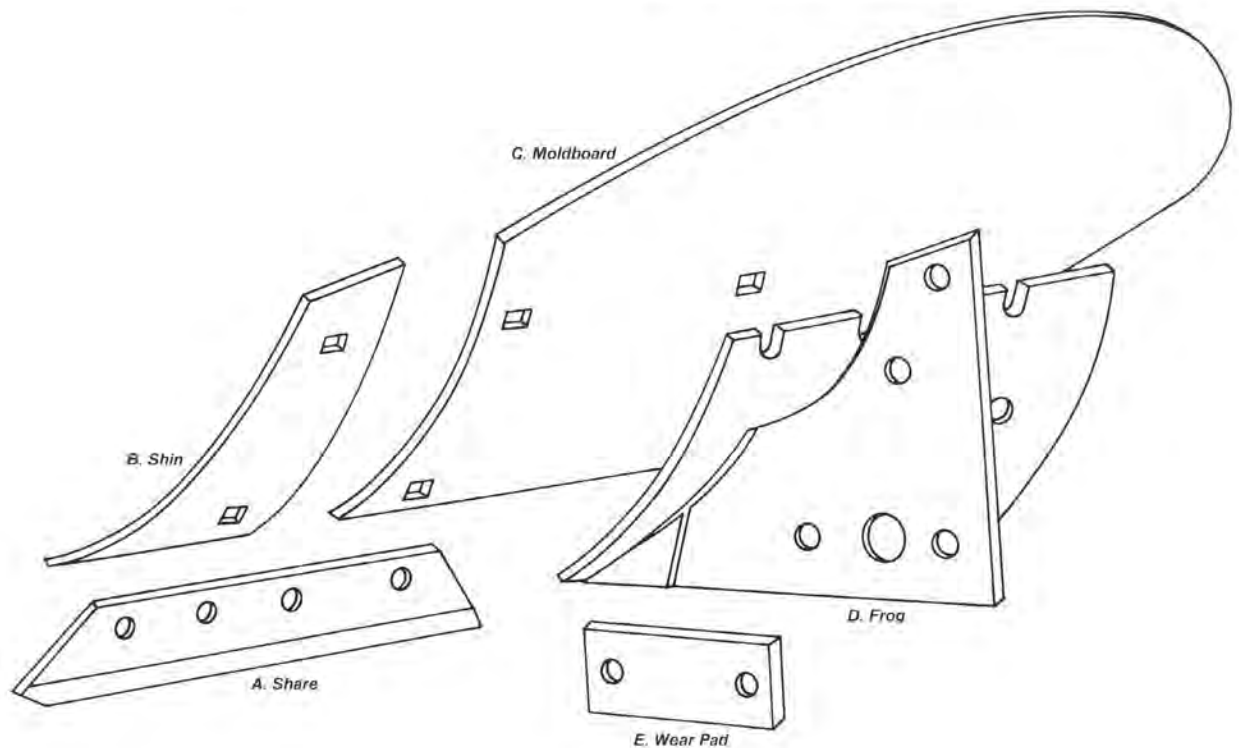

# Landside Information

**107980 Landside – FORD – Front Landside**  
 107980 R.H. Shown  
 108427 L.H. Opposite  
 General Purpose Bottom

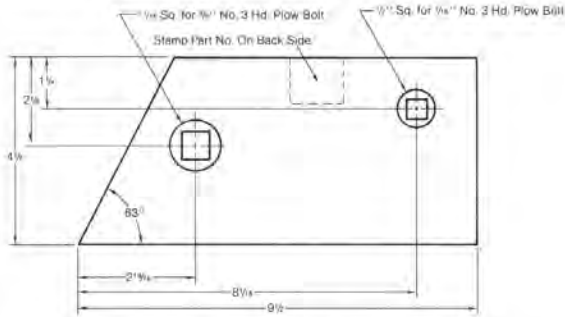

**T10856 Landside – CASE PLOWS – Front or Rear Landside for EX Series Bottoms**

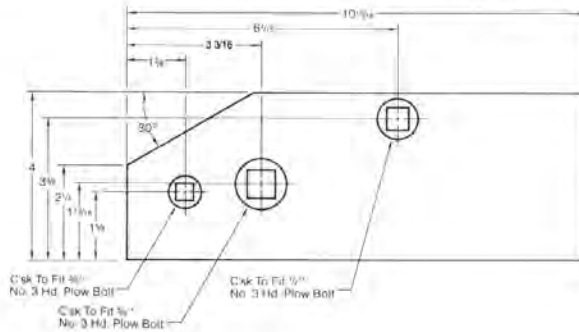

**107981 Landside – FORD – Rear Landside**  
 107981 R.H. Shown  
 108429 L.H. Opposite  
 General Purpose Bottom

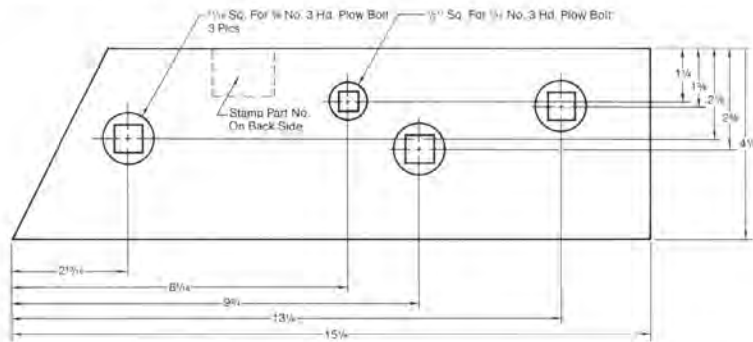

**522342 Landside – IHC – “Front” Landside**  
 Right Hand Shown  
 Left Hand Opposite  
 Super Chief Bottom

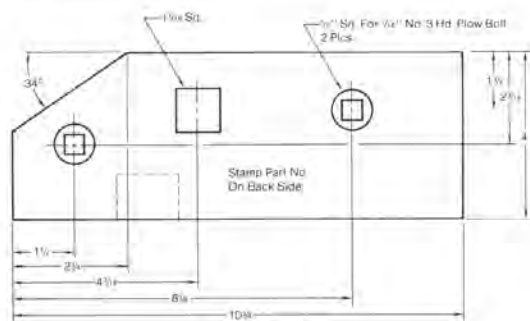

**522343 Landside – IHC – “Rear” Landside**  
 Right Hand Shown  
 Left Hand Opposite  
 Super Chief Bottom

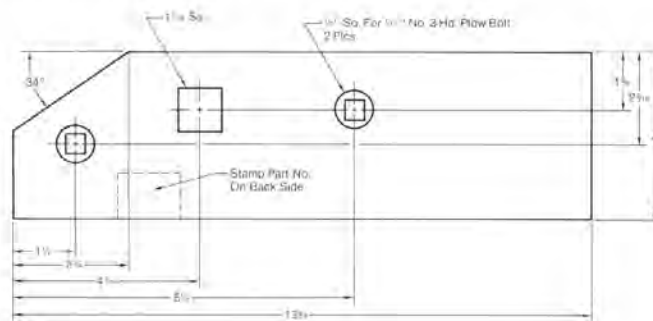

# Landside Information

**A16493 Landside — JOHN DEERE**  
 Front or Rear Landside for all "HS" or "NU" Series  
 Plow Bottoms. Use with AA 15262 Wear Pad.

A16493 R.H. Shown  
 A16494 L.H. Opposite

**AA15262 Wear Pad/Heel - JOHN DEERE HS & NU**

AA15262 R.H. Shown  
 AA15263 L.H. Opposite

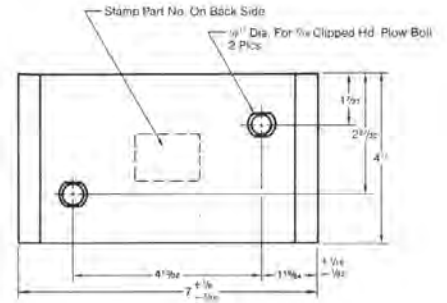
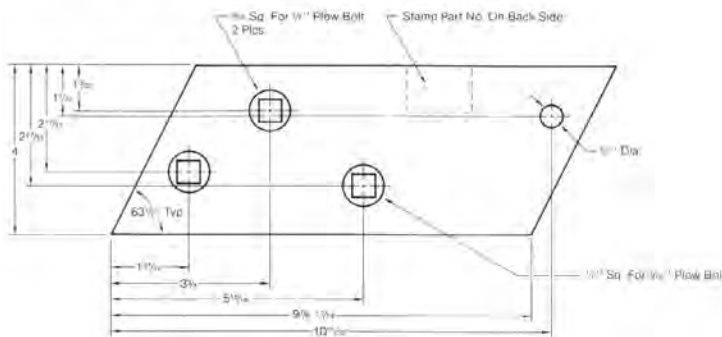

**660003 Landside — MASSEY-FERGUSON — "Rear" Landside for "N" — "N-Heavy Duty" Bottom**

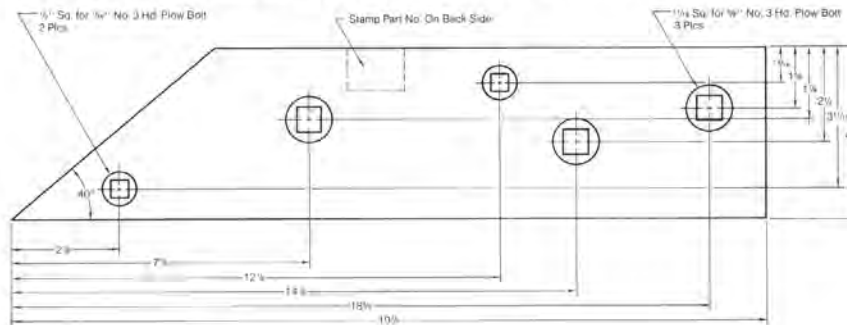

**495937 Landside — MASSEY-FERGUSON — Front or Rear Landside for "N" Heavy Duty & High Speed use in conjunction with Deere AA 15262 wear pad.**

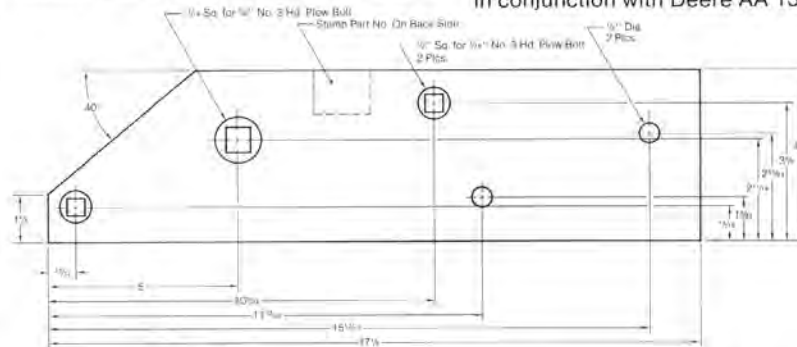

**660002 Landside — MASSEY FERGUSON — Front Landside for "N" and "N-Heavy Duty" Bottom.**

660002 R.H. Shown  
 661580 L.H. Opposite

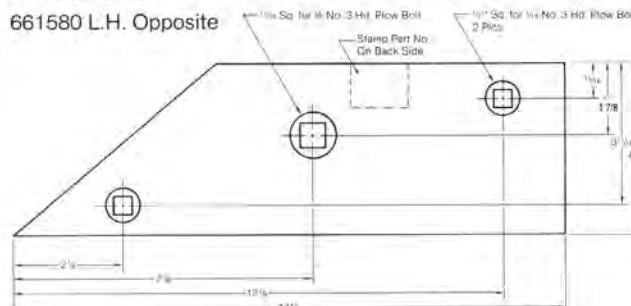

# Landside Information

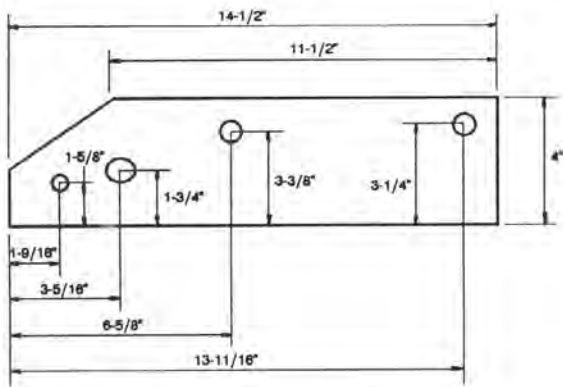

**T51968 OFFSET LANDSIDE**  
 3/8 X 1-1/2-5/8 X 2-1/2 - 1/2 X 2-1/4-7/16 X 1-1/2

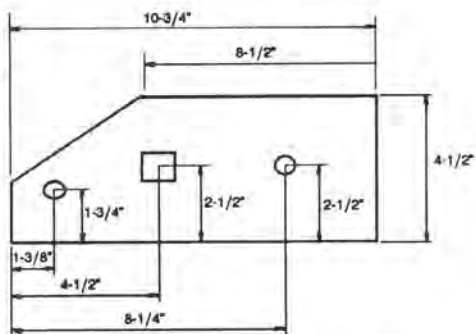

**489465 RH LANDSIDE**  
**542417 LH LANDSIDE**  
 7/16 X 1-3/4 - 7/16 X 1-3/4

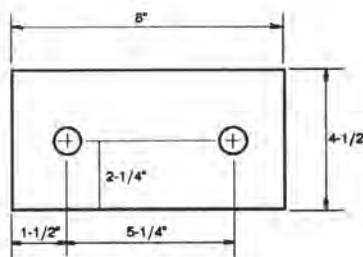

**A27862 LANDSIDE**  
 5/8 X 3-1/2-5/8 X 3-1/2

# Plowshare Information

## ALLIS CHALMERS

**AM16-4RS**

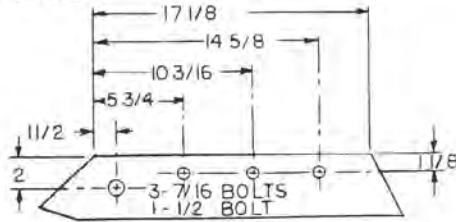

**AM18-4RS**

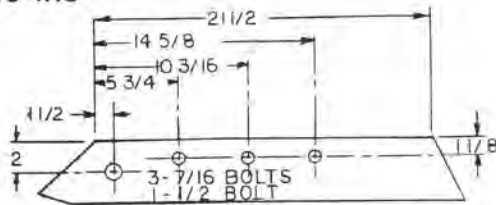

## FORD

**FF14-3RS**

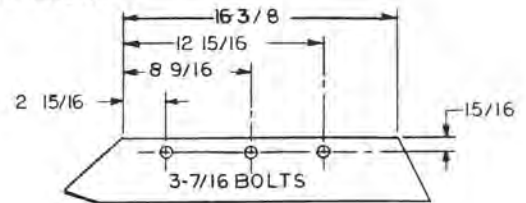

**FF16-3RS**

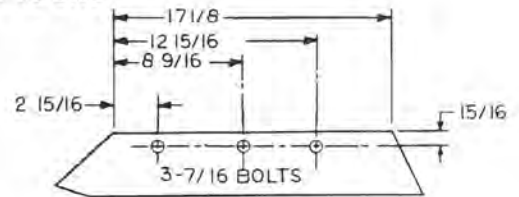

**FF14-4RS**

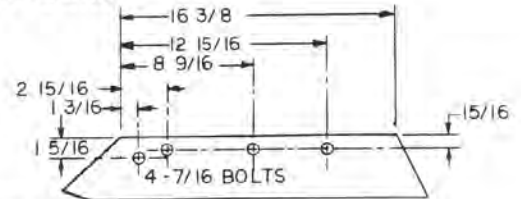

**FF16-4RS  
FF16-4LRS**

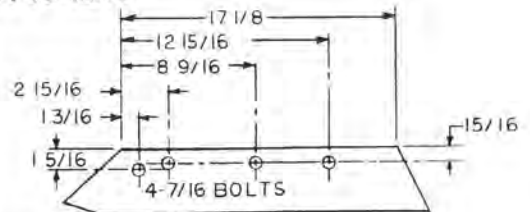

**FF18-5RS**

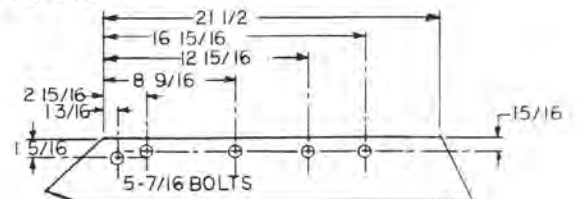

# Plowshare Information

## IHC

## J. I. CASE

MI14-3RS

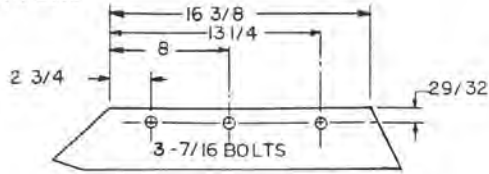

MI16-3RS

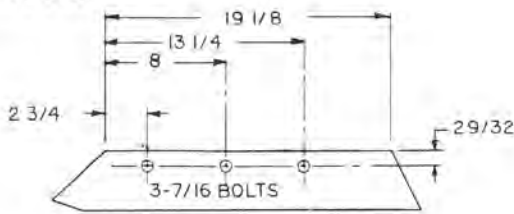

IH14-4RS

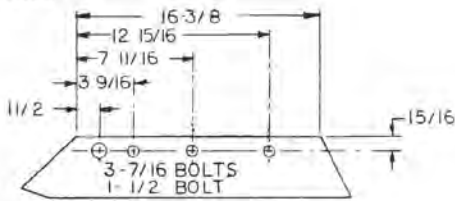

IH16-4RS  
IH16-4LRS

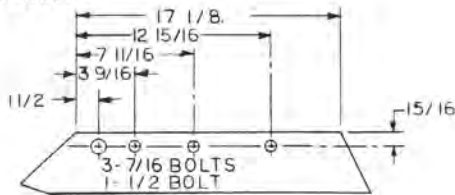

IH18-4RS  
IH18-4LRS

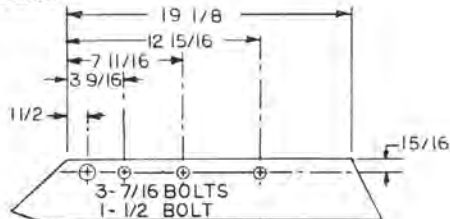

CA16-3RS

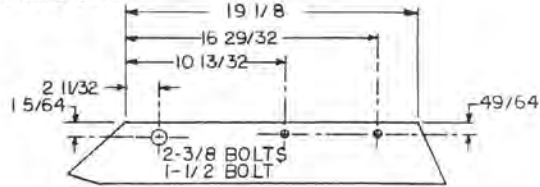

CA16-4RS  
CA16-4LRS

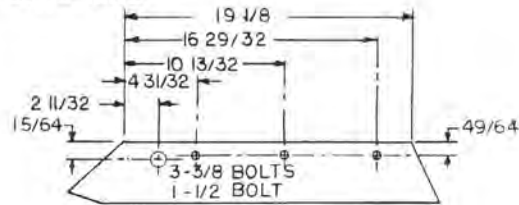

## JOHN DEERE

JD14-3RS

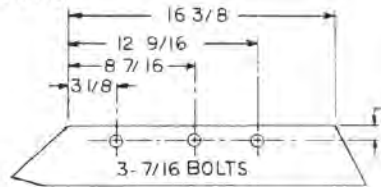

JD16-3RS

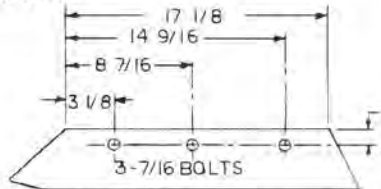

JD14-4RS

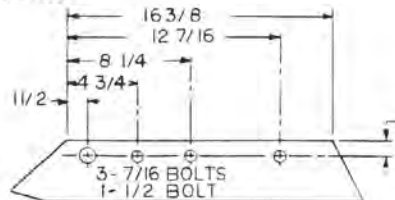



# Plowshare Information

## JOHN DEERE

**JD16-4RS  
JD16-4LRS**

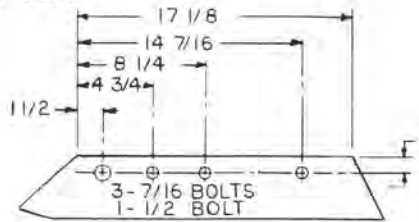

**JD18-5RS  
JD18-5LRS**

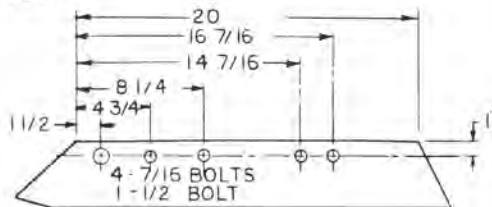

**JD18-3RS**

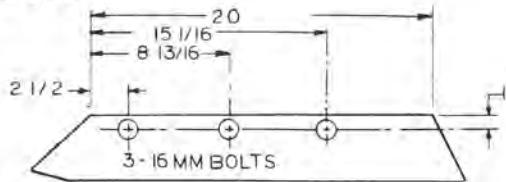

## MASSEY FERGUSON

**MI14-3RS**

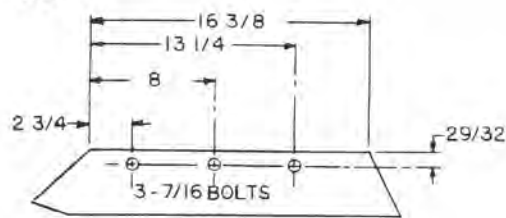

**MI16-3RS**

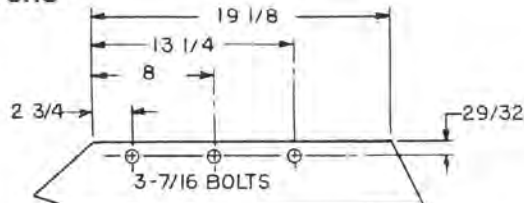

**MF14-4RS**

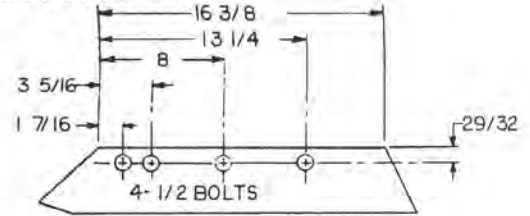

**MF16-4RS  
MF16-4LRS**

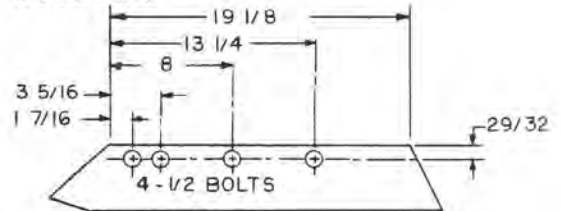

**MF18-4RS  
MF18-4LRS**

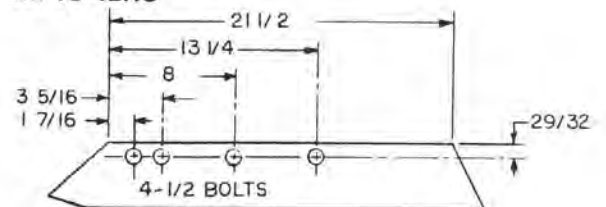

## MELROE

**MM14-4RS**

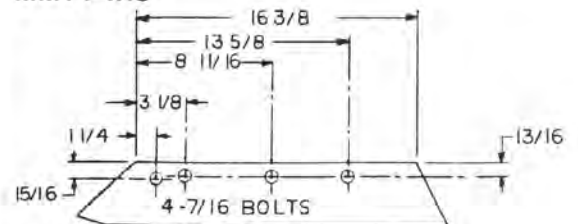

**MM16-4RS**

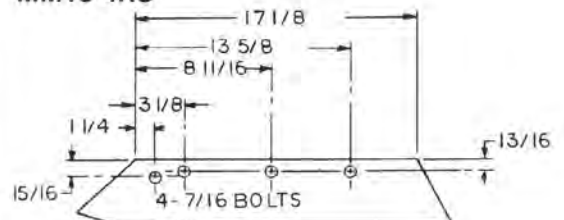

# Plowshare Information

**MM18-4RS**

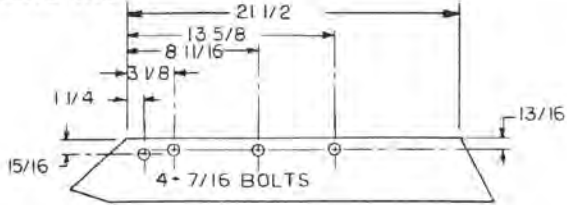

**MR16-4RS**

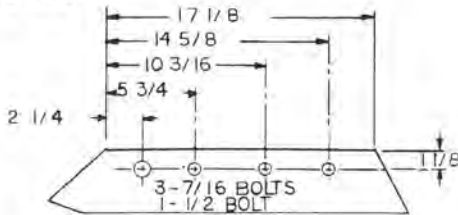

**MR18-4RS**

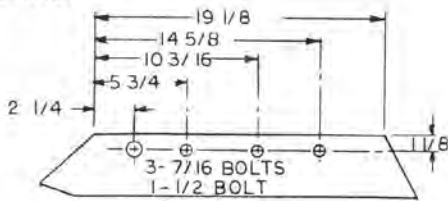

**OLIVER-WHITE-M&M**

**OM14-4RS**

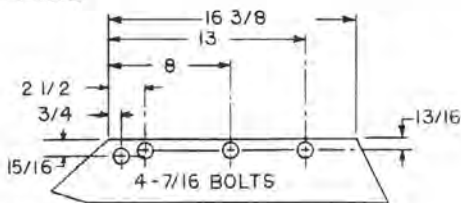

**OM16-4RS  
OM16-4LRS**

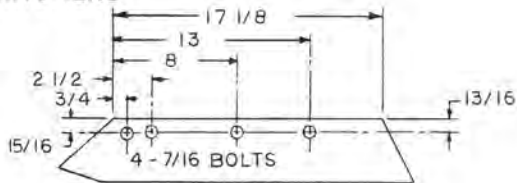

**OM18-5RS  
OM18-5LRS**

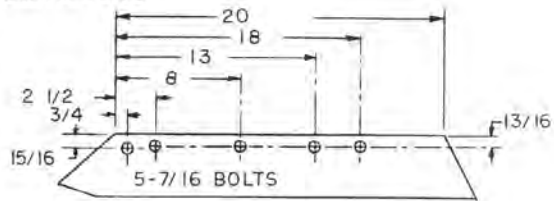

**OC16-4RS  
OC16-4LRS**

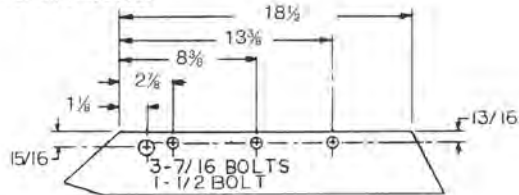

**OC18-5RS  
OC18-5LRS**

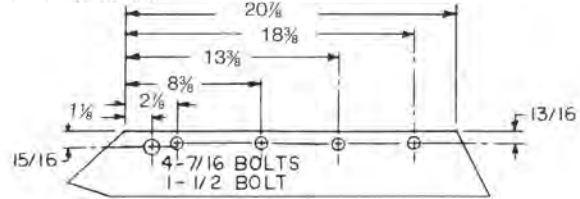

**OC20-5RS**

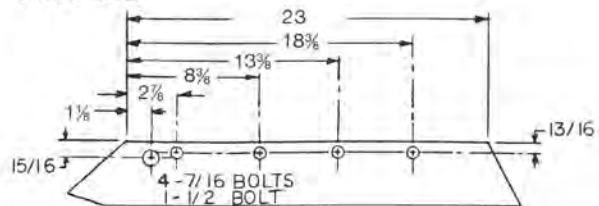

**OD18-5RS**

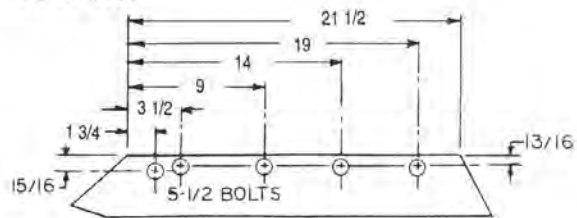

# Plowshare Information

## WATTS

### WA18-4RS

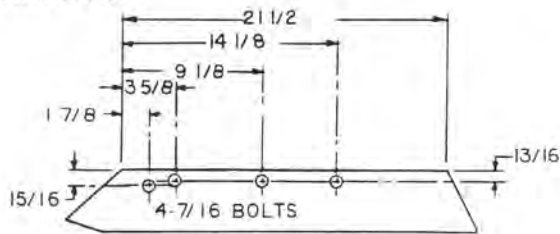

## WIL-RICH

### WR18-4RS

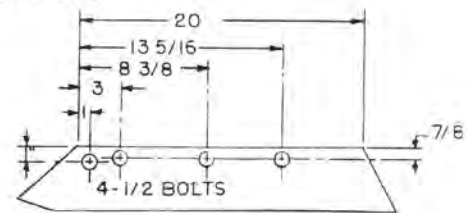

## BAKER

### BA25-6RS

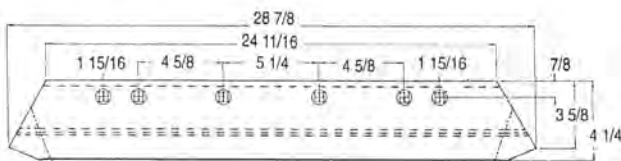

## HARRELL

### HA24-5RS

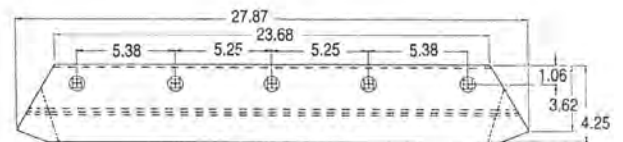

## JOHN DEERE

### JD24-4RS

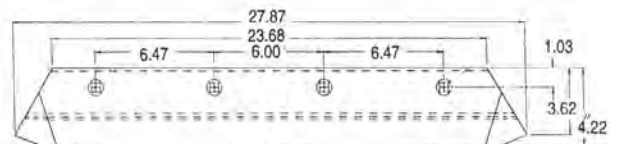

# Moldboard Information

## ALLIS CHALMERS

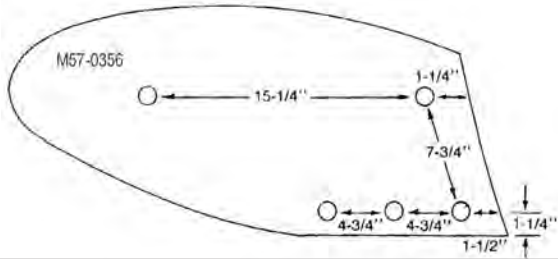

## JOHN DEERE

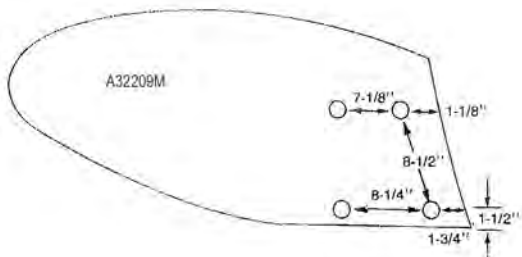
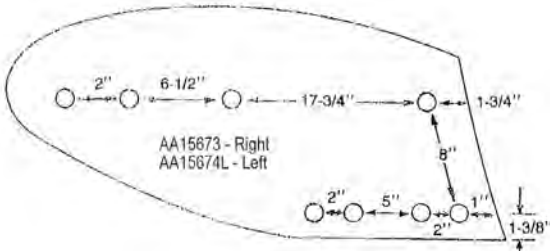
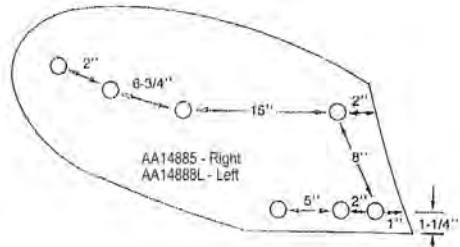
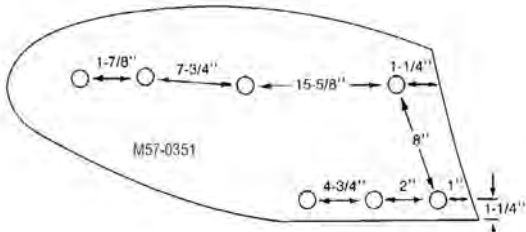
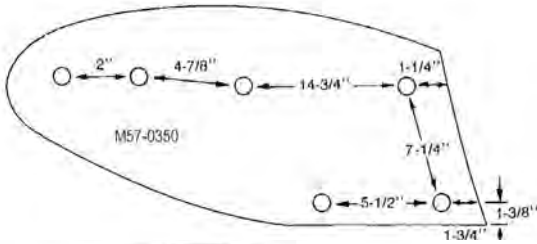

## FORD

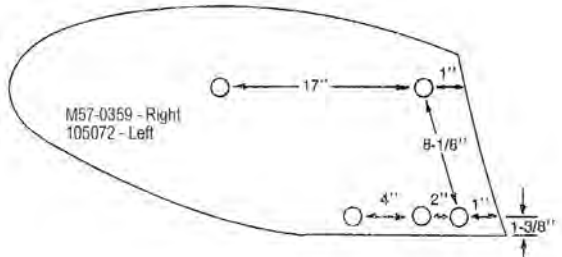
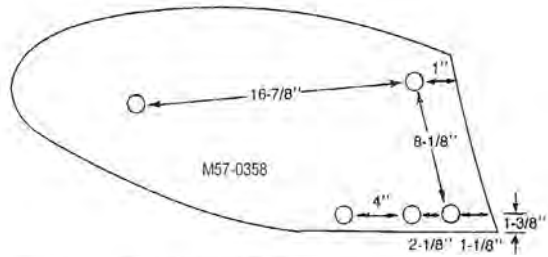

## IHC

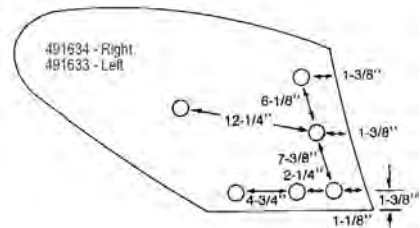
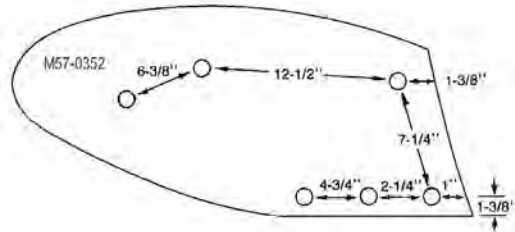

## MASSEY FERGUSON

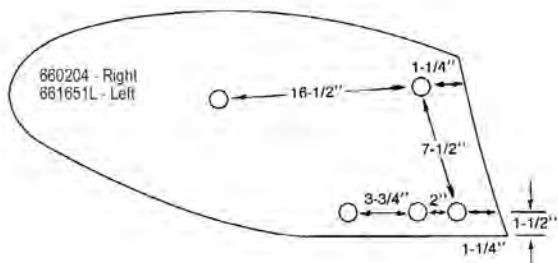

# Moldboard and Shin Information

## OLIVER/WHITE

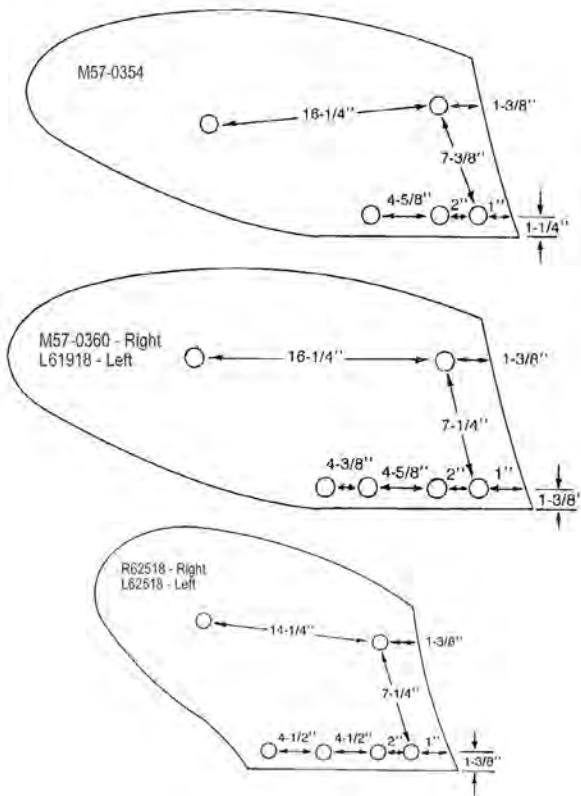

## JOHN DEERE

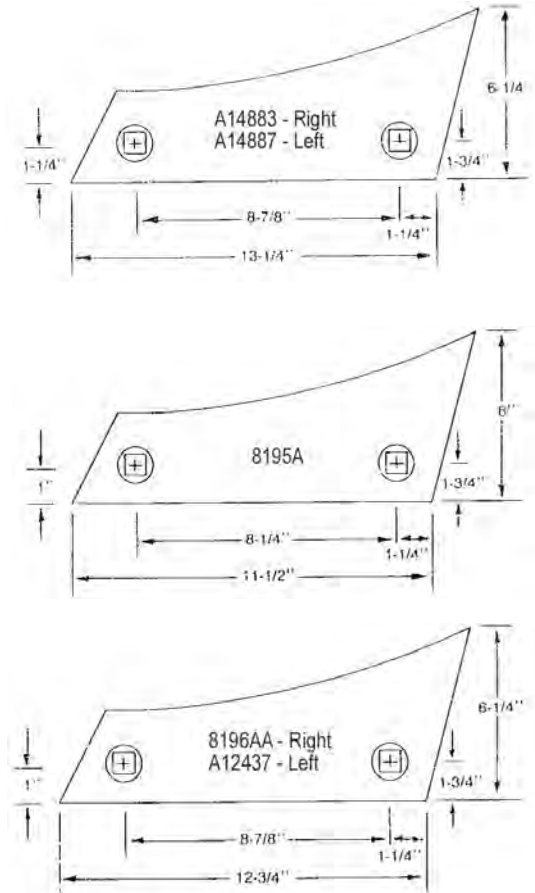

## SHINS

### ALLIS CHALMERS

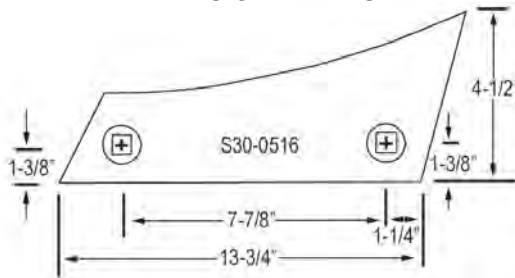

### CASE

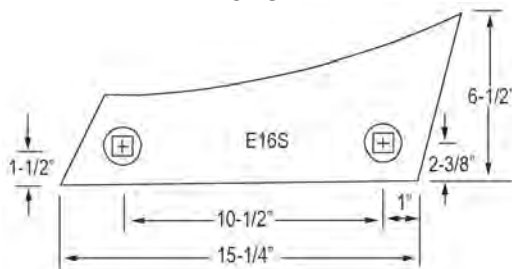

### FORD

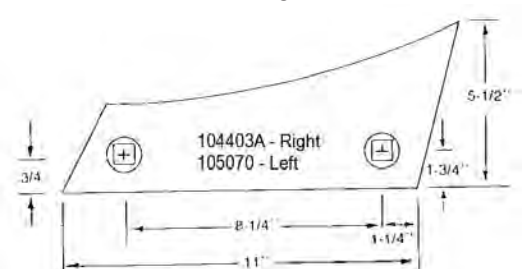

# Shin Information

## IHC

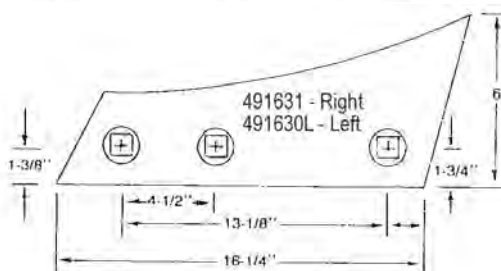
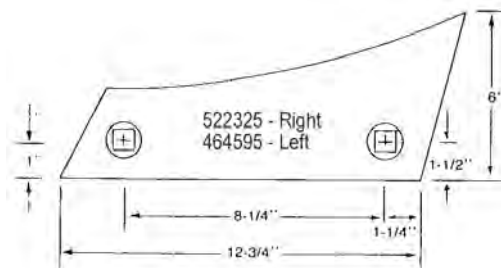

## MASSEY FERGUSON

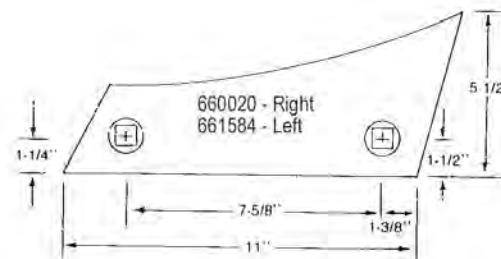

## OLIVER/WHITE

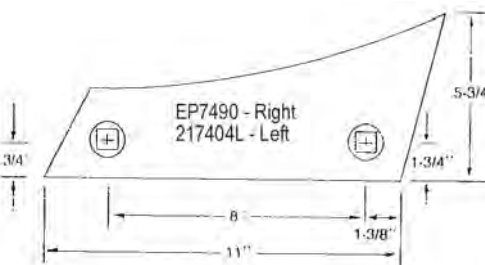
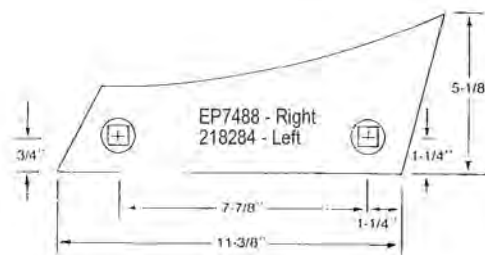

**SWEEP TERMINOLOGY**

- A. **Point Suck** - Concentrated soil penetration point of the sweep. Manufactured on a lower horizontal plane than the wings to provide increased soil penetration.
- B. **Bevel** - Edges of wings are forged in a press so the sweep self-sharpens with field use.
- C. **Stem Angle** - Refers to the angle the sweep shank forms with the horizontal plane of the ground. Determines the depth of soil penetration.
- D. **Size** - Refers to the distance between the two outside edges of the wings of a sweep.
- E. **Crown** - The distance from the ground to the tip of the wing and lower bolt hole measured on a level plane. These measurements determine the volume of dirt that the sweep will go through. We offer low and medium crown sweeps.

**DISC BLADE TERMINOLOGY**

**Normal Concave**

Recommended in light soils and in rocky fields to control soil movement. In rocky conditions, they reduce stress loads on the frame and gang components. In other soil types, especially with 7 1/4 to 9 inch blade spacing, concave blades also may be your choice for general purpose disking and chemical incorporation.

**John Deere Design Conical**

Recommended for medium and heavy soils for more aggressive cutting and mixing action. May also penetrate better than spherical blades.

**Case - IH Design Flat Back**

Offered as replacement for O.E.M. blade. Same cutting and soil movement action as a normal concave disc.

**Miller (New Holland) Design Special**

Offered as replacement for O.E.M. blade. These blades feature a special shallow concavity.

**Plain Disc**

Recommended for most tillage applications.



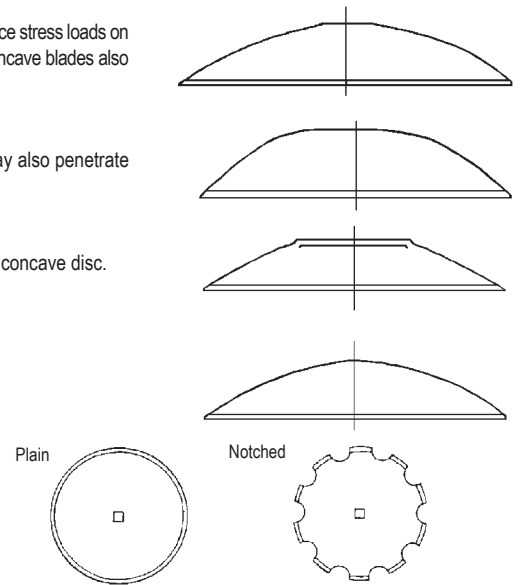

**Notched Disc**

Improves penetration in hard ground and slicing action in heavy residue.



**DISC BLADE WARRANTY POLICY**

Note: Disc Blades carry 100% warranty on edge breakage or bending up to 1" in diameter wear.

	<p><b>Full Credit</b> Straight directional break due to defective material.</p>		<p><b>Full Credit</b> Laminated or split, caused by defective material.</p>
	<p><b>No Credit</b> Irregular breaks or disc blade fracture resulting from overloading in rock or stump conditions or other solid objects.</p>		<p><b>No Credit</b> Irregular breaks or disc blade fracture resulting from overloading in rock or stump conditions or other solid objects.</p>
			<p><b>No Credit</b> Center broken out caused by either implement design fault, excessive draft, excessive flexing of disc or loose gang bolts in rock or stump conditions.</p>

# Disc Blade Application Chart

Disc Model No.	Axle Size
<b>Allis Chalmers</b>	
2100-2300	1 1/2 Square
3400	1 1/2 Round
<b>Amco</b>	
WOD, WTD	1 1/8 Square
WOE	1 3/8 Round
WOR, WOJ	1 1/2 Square
WTF, WTJ	1 1/2 Square
48, 85, 148, 185, 248, 258	
F15B & F15	1 1/2 Square
<b>Athens</b>	
48	1 Square
62	1 1/8 Square
126	1 1/2 Square
131	1 1/2 Square
<b>Binkley</b>	
700 Series	1 1/2 Round
<b>Blanton</b>	
4500	1 1/2 Square
B900	1 1/8 Square
B1000	1 1/8 Square
3000H	1 1/2 Square
<b>Burch</b>	
Kwik-Set	1 1/8 Square
209	1 1/8 Square
208 BW	1 1/2 Round
Tru-Cut	7/8 Square
<b>Bush-Hog</b>	
245	1 1/4 or 1 1/2 Square
1440	1 1/8 Square
1445	1 1/8 or 1 1/4 Square
1450	1 1/8 or 1 1/4 Square
145	1 1/4 Square
146 Reg	1 1/4 Square
146 HD	1 1/2 Square
1422	1 or 1 1/8 Square
1424	1 1/8 Square
1432	1 1/8 Square
1436	1 1/8 Square
1437	1 1/8 or 1 1/2 Square
1438 & 1439	1 1/8 Square
1444	1 1/8 Square
Rolling Bedder	1 1/8 Square
<b>Dunham Lehr</b>	
GC	1 1/8 Square
<b>Ford</b>	
201	1 Round
202	1 Round
204	1 Round
219	1 1/2 Square
220	1 1/8 Square
221	15/16 Round
222	1 1/8 Square
236	1 1/2 Square
243	1 1/2 Round
<b>Hesston</b>	
2410	1 3/4 Round

Disc Model No.	Axle Size
<b>International Harvester</b>	
122, 132, 350, 370	1 1/8 Square
400, 470	1 1/8 Square
490	1 1/8 Square
500	1 1/2 Square
610	1 1/2 Square
630	1 1/2 Round
<b>John Deere</b>	
105	1 Round
115	1 1/8 Round
225	1 1/2 Round
425	1 1/2 Round
1630	1 1/2 Square
100	1 1/8 Square
110	1 1/8 Square
200 & 210	1 1/8 Square
215	1 1/2 Round
220	1 1/8 Square
225	1 1/2 Round
230 (Cone Disc)	1 1/8 Square
235	1 1/8 & 1 1/2 Round
310	1 1/4 Square
425	1 1/2 Round
525	1 1/2 Round
1630 & 1635	1 1/2 Square
1640	1 1/2 Square
2620 (Cone Disc)	1 1/2 Square
2621	1 1/2 Square
2650	1 3/4 Square
2651	1 3/4 Square
2700	2 1/4 Square
BWA	1 1/4 Square
BWF	1 1/4 Square
<b>Kewanee</b>	
800	1 1/8 Square
1000	1 1/8 Square
<b>Krause</b>	
1952-1956-60-70	1 1/2 Round
1959-63-73	
1968-1969-1979	1 1/2 Round
1965-1966-1976	1 1/2 Round
2100 Series	1 1/2 Round
2200 Series	1 1/2 Round
2400 Series	1 1/2 Round
2400 Series	1 3/4 Round
3100 Series	1 1/2 Round
3200 Series	1 3/4 Round
1498 & 1499	1 1/2 Round
1465-1470	1 3/4 Round
1580-1480	1 1/2 Round
1710-1769	1 3/7 Round
1912-1915-1918	1 1/2 Round
1901-1904-1907	1 1/2 Round
1922-1925-1928	1 1/2 Round
1921-1924-1927	1 1/2 Round
1959-1963-1973	1 1/2 Round
<b>Long</b>	
953	7/8 Square
1080	1 1/2 Square
1087, 88, 89	1 1/2 Square

Disc Model No.	Axle Size
<b>Massey Ferguson</b>	
MF520, 620, 820	1 1/4 Square
MF21	1 Square
MF30, 720	1 1/2 Square
MF25, 39	1 Round
MF40	1 1/2 Square
MF52	1 1/8 Square
MF72	1 1/8 Round
<b>Miller</b>	
Series I	1 3/4 Round
Series II	1 3/4 Round
<b>New Holland</b>	
OD100	1 3/4 Round
OD200	1 3/4 Round
OD300	2 Round
TD100	1 3/4 Round
TD200	1 3/4 Round
<b>Rhino</b>	
177	1 1/2 Square
Flex 90	1 1/8 Square
Flex 90B	1 1/4 Square
<b>Sunflower</b>	
1210	1 1/2 Round
1211	1 3/4 Round
1230	1 1/2 Round
1231	1 3/4 Round
1320 & 1330	1 3/4 Round
1321 & 1331	1 3/4 Round
1430 & 1440	1 3/4 Round
H-3 & H-4	1 3/4 Round
1431-1441	1 3/4 Round
1541	
<b>Schafer</b>	
355	1 3/4 Round
555	2 Round
<b>Taylor Way</b>	
200251 thru 200268	1 1/2 Square
200108 thru 200118	1 1/8 Square
20023	1 1/8 Square
20024	1 1/8 Square
200196-200199	1 1/8 Square
2000051-2000068	1 1/8 Square
200284-200291	1 1/2 Square
200310-200315	1 1/2 Square
2001 Series	1 1/8 Square
200011	7/8 Square
200013	7/8 Square
200035	1 1/8 Square
200036	1 1/8 Square
200037	1 1/8 Square
200048	1 1/8 Square
200049	1 1/8 Square
2000165	7/8 Square
2000166	7/8 Square
2000167	7/8 Square
<b>Vasser</b>	
Disc-Ezy	1 1/8 Square
<b>White</b>	
251	1 1/8 Square
252	1 1/8 Square
253	1 1/8 Square
263	1 1/8 Square
265	1 1/8 Square
271,272	1 1/8 Square
281	1 1/2 Square



# Application Charts

## CHISEL PLOW (WHEATLAND) SWEEPS

Application	Bolt Size *	Hole Spacing	Stem Angle
Allis Chalmers 22" - 32" (now Deutz-Allis)	7/16" R	2 1/4" - 2 1/2"	43°
Anderson	7/16" R	2 1/4" - 2 1/2"	50°
Brady	7/16" R	2 1/4" - 2 1/2"	50°
Case (Later Models)	7/16" R	2 1/4" - 2 1/2"	50°
Case-IH	7/16"	2 1/4" - 2 1/2"	43°
C.C.I.L. 1" Thick Shank	7/16" R	2 1/4" - 2 1/2"	50°
C.C.I.L. 1 1/4" Thick Shank	1/2"	2 1/4" - 2 1/2"	43°
Cockshutt 240, 246, 247, 476, 249	7/16" R	2 1/4" - 2 1/2"	50°
Crown	1/2"	2 1/4" - 2 1/2"	50°
DMI	1/2"	2 1/4" - 2 1/2"	50°
Dengelman	7/16" R	2 1/4" - 2 1/2"	50°
Edwards	7/16" R	2 1/4" - 2 1/2"	50°
Flexi-Coil (2" x 1" Shank)	1/2"	2 1/4" - 2 1/2"	50°
Ford 131	7/16" R	2 1/4" - 2 1/2"	50°
Friggstad	7/16" R	2 1/4" - 2 1/2"	50°
Glencoe (High Clearance)	7/16" R	2 1/4" - 2 1/2"	50°
Graham (High Clearance)	7/16" R	2 1/4" - 2 1/2"	50°
Hiniker	1/2"	2 1/4" - 2 1/2"	50°
IHC 10, 50, 55, 75, 64 S	7/16" R	2 1/4" - 2 1/2"	43°
Ingham	1/2"	2 1/4" - 2 1/2"	43°
Jeoffery 16"	7/16" R	2 1/4" - 2 1/2"	50°
Jeoffery 22" - 32"	7/16" R	2 1/4" - 2 1/2"	43°
John Deere	7/16" R	2 1/4" - 2 1/2"	50°
Kewanee	7/16" R	2 1/4" - 2 1/2"	50°
Killbery	7/16" R	2 1/4" - 2 1/2"	50°
Krause (High Clearance)	7/16" R	2 1/4" - 2 1/2"	50°
Leon	1/2"	2 1/4" - 2 1/2"	50°
Massey Harris	7/16" R	2 1/4" - 2 1/2"	43°
Massey "Trash King"	7/16" R	2 1/4" - 2 1/2"	50°
Mel-Cam	7/16" R	2 1/4" - 2 1/2"	50°
Mel-Cam Cultivator	7/16" R	2 1/4" - 2 1/2"	43°
Minneapolis Moline T600, 1500, 1800	7/16" R	2 1/4" - 2 1/2"	50°
Minn-Toba 120, 176	7/16" R	2 1/4" - 2 1/2"	50°
Minn-Toba 3 Point Hitch	7/16" R	2 1/4" - 2 1/2"	43°
Mohawk	1/2" R	2 1/4" - 2 1/2"	43°
Morris 220	7/16" R	2 1/4" - 2 1/2"	43°
Morris MP 912 & Magnum	1/2"	2 1/4" - 2 1/2"	50°
Noble XR-20	7/16" R	2 1/4" - 2 1/2"	50°
Oliver	7/16" R	2 1/4" - 2 1/2"	43°
Robin/Nodwell	7/16" R	2 1/4" - 2 1/2"	50°
Rogin	7/16" R	2 1/4" - 2 1/2"	50°
Roll-O-Cone	1/2"	2 1/4" - 2 1/2"	50°
Roll-O-Flex	7/16" R	2 1/4" - 2 1/2"	50°
Schulte 300	1/2"	2 1/4" - 2 1/2"	50°
Sunflower	7/16" R	2 1/4" - 2 1/2"	50°
Versatile	7/16" R	2 1/4" - 2 1/2"	50°
Victory	7/16" R	2 1/4" - 2 1/2"	50°
Wil Rich	1/2"	2 1/4" - 2 1/2"	43°

\* (R) In some instances our inventory reducer bolt (7/16" bolt w/1/2" head) is required.

## FIELD CULTIVATOR SWEEPS

Application	Bolt Size	Hole Spacing	Stem Angle
Allis Chalmers (now Deutz-Allis)	(2) 7/16"	2"	54°
Allis Chalmers 1200, 1300	3/8"	N/A	N/A
Anderson	(2) 3/8"	1- 3/4"	47°
Baker	(2) 3/8"	1- 3/4"	41°
Becker/ATI	3/8"	N/A	N/A
Ber-Vac	3/8"	N/A	N/A
Bourgault	(2) 7/16"	1- 3/4"	47°
Brady (Prior to '70-'71)	(2) 3/8"	1- 3/4"	47°
Brady (After '70-'71)	7/16"	1- 3/4"	47°
Buckeye	3/8"	N/A	N/A
Bush Hog	(2) 3/8"	1- 3/4"	47°
Calkins	(2) 3/8"	1- 3/4"	47°
Case F.C., F.C.M., F.C.S.W.	(2) 3/8"	1- 3/4"	47°
C.C.I.L.	(2) 3/8"	1- 3/4"	47°
Cockshutt 285, 485	(2) 3/8"	1- 3/4"	47°
Crustbuster	(2) 7/16"	1- 3/4"	47°
Flexi-Coil 200, 400 Series	(2) 7/16"	1- 3/4"	47°
Ford 208	(2) 3/8"	1- 3/4"	47°
Frontier	(2) 7/16"	1- 3/4"	47°
Glencoe, F.C., M.F.C., F.C.S.W.	(2) 3/8"	1- 3/4"	47°
Note: Row Crop Cultivator Uses Same Sweep			
Glencoe Soil Finisher	3/8"	N/A	N/A
Hesston	(2) 7/16"	1- 3/4"	47°
Hiniker	(2) 7/16"	1- 3/4"	47°
IHC & Case IH	(2) 7/16"	1- 3/4"	47°
Deere 1000 Series	(2) 3/8"	1- 5/8"	41°
Deere CCA, C10, C20	3/8"	1- 3/4"	41°
Deere 960-FC	(2) 7/16"	1- 3/4"	47°
Kent	(2) 7/16"	1- 3/4"	47°
Kewanee	(2) 7/16"	1- 3/4"	47°
Koehn	3/8"	N/A	N/A
Kongskilde	3/8"	N/A	N/A
Krause 600/900	(2) 3/8"	1- 3/4"	47°
Landoll	(2) 7/16"	1- 3/4"	47°
Massey Ferguson 160	(2) 3/8"	1- 3/4"	47°
Minneapolis Moline FT200	(2) 3/8"	1- 3/4"	47°
Morris L240, L320	(2) 3/8"	1- 3/4"	47°
Noble Mix-N-Till	3/8"	N/A	N/A
Oliver 245, 345	(2) 3/8"	1- 3/4"	41°
Oliver 285, 385, 485	(2) 3/8"	1- 3/4"	47°
Rhino/Athens	(2) 7/16"	1- 3/4"	47°
Sunflower	7/16"	1-3/4"	47°
Taylor	(2) 3/8"	1- 3/4"	47°
Unverferth Culti-System	3/8"	N/A	N/A
Vicon/McKee	3/8"	N/A	N/A
Wil Rich	(2) 7/16"	1- 3/4"	47°
Win Power 1500	(2) 7/16"	1- 3/4"	47°
White Farm Equipment	(2) 3/8"	1- 3/4"	47°
Glencoe (old) 1250 "Double Shank"	(2) 3/8"	1- 3/4"	41°

## STEM ANGLES - FIELD CULTIVATORS

MACHINE	STEM ANGLE				HOLE CENTERS			BOLT CENTERS		
	41°	43°	47°	52°	1-5/8"	1-3/4"	2"	3/8"	7/16"	1/2"
ALLIS CHALMERS				•			•			•
ALLIS CHALMERS				54"						•
ALLIS CHALMERS (early models)	•							•		
ANDERSON			•			•		•		
BAKER	•							•		
BOURGAULT 6200, 6800, 8800, 8810, 5710 Air Drill			•			•				•
BRADY (before 70-71)	•					•		•		
BRADY (after 70-71)			•					•		
BRADY 3400			•						•	
BRADY		•						•		
BRILLION (prior 1986)	•							•		
BRILLION (after 1986)			•						•	
BUFFALO (no till)				54"					•	
BUSH HOG			•			•		•		
BUSH HOG			•						•	
CALKINS			•					•		
CASE FC, FCW, FCM			•			•		•		
CASE Minn-Toba				•			•		•	
CASE IH 45, 4300, 4500, 4600, 4700, 4800, 4900			•			•			•	
CCIL CI-200, 179, 279, 379			•			•		•		
COCKSHUTT (early models)	•							•		
COCKSHUTT 237, 239, 337				•			•		•	
COCKSHUTT 285, 485			•			•		•		
CRUSTBUSTER			•						•	
DAKON			•						•	
DEGELMAN 3000 series			•			•			•	
DMI TigerMate			•						•	
EZEE-ON			•			•				•
FARMERS FACTORY			•						•	
FLEXI-COIL 820, ST820, 5000, 7500 (350 lb.)			•			•				•
FLEXI-COIL 200, 400, 420, 800			•			•			•	
FORD 208			•			•		•		
FORREST CITY Do-All			•	54"					•	
FRIGGSTAD			•						•	
GLENCOE Double Shank 1250	•							•		
GLENCOE PFC, MBC, PCMW			•			•		•		
GLENCOE FC, MFC, FCSW			•					•		
HESSTON			•			•			•	
HINIKER			•			•			•	
IHC 45, 46, 47			•			•			•	
INGHAM			•						•	
JEFFROY 450			•			•		•		
JOHN DEERE OLD		•				•		•		
JOHN DEERE 1000, 1010, 1050, CCA, C10, C20	•							•		
JOHN DEERE 730, 940, 960, 1060			•			•			•	
KENT			•			•			•	
KEWANEE			•			•		•		
KRAUSE 600, 900, 5000, 6300, 6500, 7000			•			•		•		
KRAUSE K-Tine	•							•		
LANDOLL			•					•		
LEON VibraFlex			•			•		•		
M & W 724			•						•	
MASSEY FERGUSON 160			•					•		
MASSEY HARRIS			•						•	
MINN-TOBA LDC, 726, 729				•			•		•	
MINNEAPOLIS-MOLINE FT200			•			•		•		
MORRIS L240, L320, L249			•			•		•		

## STEM ANGLES - FIELD CULTIVATORS

MACHINE	STEM ANGLE				HOLE CENTERS			BOLT CENTERS		
	41°	43°	47°	52°	1-5/8"	1-3/4"	2"	3/8"	7/16"	1/2"
MORRIS 9000, 9001, Challenger 2, Maxim 1 & 2			•					•		
MORRIS Concept 2000 (4000 lb. trip)			•							•
MULTIPLEX 245, 345			•					•		
NOBLE			•						•	
OLIVER	•						•	•		
OLIVER 285, 385, 485			•				•	•		
OLIVER 235, 245, 345		•						•		
RHINO (Athens)			•						•	
SUNFLOWER			•						•	
TAYLOR			•				•	•		
VALMAR			•				•		•	
VERSATILE 100		•					•		•	
VIBRASHANK			•				•		•	
WHITE			•					•		•
WHITE			•				•	•		
WHITE 245, 345	•							•		
WIL-RICH			•				•		•	
WINPOWER 1500			•				•		•	

## STEM ANGLES - CHISEL PLOWS

MACHINE	STEM ANGLE				HOLE CENTERS		BOLT CENTERS	
	43 <sup>o</sup>	47 <sup>o</sup>	50 <sup>o</sup>	54 <sup>o</sup>	2-1/4"	2-1/2"	7/16"	1/2"
ALLIS CHALMERS 22" & 32", 1400 Chiselvator	•				•		•	
ALLIS CHALMERS (other)			•		•		•	
ANDERSON			•		•		•	
BOURGAULT 9200, 9400, 9800			•		•			•
BRADY			•		•		•	
BRANDT				•	•		•	
BUSH HOG			•		•		•	
CALKINS 32" shank			•					
CASE older models		•			•		•	
CASE		•			•			•
CASE 10, 50, 55, 645, 4700, 4900, 5000	•				•			•
CASE WWC-37, 324			•					
CASE T25118W, T265663				•	•		•	
CASE CP700, 900, 110				•				
CASE IH Vibra Chisel	•				•	•		•
CASE IH 5800, 5850, 5900, PTX300, PTX600			•		•			•
CCIL 203, 204, 205 1 1/4" shank	•					•		•
CCIL high clearance 1" shank			•					
CCIL 806, 807, 808	•					•		•
CCIL Thick Shank - 806 (1 1/4" thickness)			•		•		•	•
COCKSHUTT 240, 246, 247, 249, 476			•		•		•	
CROWN			•		•		•	
DEGELMAN 500			•		•		•	
DEGELMAN 3000-2			•		•			•
DEMSTER							•	
DMI			•					
EDWARDS			•		•		•	
EZEE-ON			•		•			•
FARMHAND / GLENCOE		•						
FORD 131			•		•		•	
FORD 131				•	•		•	
FORD		•			•		•	
FORDSON MAJOR 513-1, 713-20				•	•		•	
FLEXI-COIL 300, 340, 600, 800CP			•		•			•
FLEXI-COIL 1" x 2" shank			•					
FLEXI-COIL 1 3/4" x 7/8" shank		•						
FRIGGSTAD older models			•		•		•	
FRIGGSTAD			•		•			•
GLENCOE		•			•		•	
GLENCOE		•			•			•
GLENCOE high clearance			•		•		•	
GLENCOE Giant 6				•	•		•	
GRAHAM Planet			•		•		•	
GRAHAM			•		•			•
GRAHAM 400, 500, 1600, 2600				•	•		•	
GYSLER		•			•		•	
HESSTON			•		•		•	
HESSTON			•		•			•
HINIKER			•					•
INGHAM	•				•		•	
IHC 10, 50, 55, 75, 509, 645	•				•	•		•
JEOFFROY 16"			•		•		•	
JEOFFROY 22", 32"	•				•		•	
JOHN DEERE 100, 150, 200, 250			•		•		•	
JOHN DEERE 1600			•		•		•	•
JOHN DEERE 610, 1650, 1810			•		•			•
JOHN DEERE 610 seeding tool			•		•			•
KENT	•				•			

## STEM ANGLES CHISEL PLOWS

MACHINE	STEM ANGLE				HOLE CENTERS		BOLT CENTERS	
	43°	47°	50°	54°	2-1/4"	2-1/2"	7/16"	1/2"
KEWANEE			*					
KILBERRY			*		*		*	
KRAUSE low clearance		*			*		*	*
KRAUSE high clearance			*		*		*	*
KRAUSE				*	*		*	
LANDOLL			*					
LELY			*		*		*	
LEON			*		*		*	
MAJOR 513-1, 730-20				*				
MF	*				*		*	
MF 124, 125, 126, 128 trip				*	*		*	
MF Spring Cushion			*		*		*	
MF Trash King			*		*		*	
MASSEY HARRIS		*			*		*	*
MEL-CAM			*		*		*	
MEL-CAM Culti-Weeder	*				*		*	
MELROE (Clark)		*			*		*	*
MELROE (Clark)			*		*		*	
MINN-TOBA 3 PH	*				*		*	
MINN-TOBA 120, 176			*		*		*	
MM T600, T1500, T1800			*	*	*		*	
MM T500				*	*		*	
MOHAWK Trash King	*							
MOHAWK			*					
MORRIS 220, 4, 5, 6, 7 Series	*				*		*	
MORRIS 1982 Magnum 1	*				*			*
MORRIS Worn Trips		*			*		*	*
MORRIS Concept 2000 (755 lb. trip)			*		*			*
MORRIS Magnum II, 8900, 912, Case 8100			*		*			*
NOBLE XR20			*		*		*	
NOBLE 8000			*		*			*
OLIVER 247, 248, 347			*		*		*	
OLIVER 500 (Jeoffroy)	*				*		*	
RENN			*		*		*	
RITEWAY			*		*			*
ROBIN			*		*		*	
ROBIN				*	*		*	
ROBIN-NODWELL			*					
ROLL-O-FLEX			*		*		*	
ROGIN			*					
ROLL-O-TRIP			*					
ROLL-A-CONE			*					
SATURN			*					
SCHULTE			*					*
SUNFLOWER			*		*			
VERSATILE			*		*			
VICON			*		*			
VICTORY			*					*
WHITE 247, 249, 476			*		*		*	
WHITE 420, 435			*		*			*
WILCAR			*		*			
WIL-RICH early models	*				*		*	
WIL-RICH	*				*	*		*

## #3 HEAD PLOW BOLT WITH NUT

• Right Hand, #3 • Grade 5



B55-0220

Size	Pkg. Qty.	Order No	List
3/8" x 1-1/4"	50	B55-0225	11.44
3/8" x 1-1/2"	50	B55-0230	12.68
3/8" x 1-3/4"	50	B55-0235	13.09
3/8" x 2"	50	B55-0240	12.93
3/8" x 2-1/2"	50	B55-0245	20.76
7/16" x 1"	50	B55-0250	24.17
7/16" x 1-1/4"	50	B55-0255	17.24
7/16" x 1-1/2"	50	B55-0260	19.95
7/16" x 1-1/2"	10	B55-0260D	9.17
7/16" x 1-3/4"	50	B55-0265	22.43
7/16" x 1-3/4"	10	B55-0265D	9.17
7/16" x 2"	50	B55-0270	21.73
7/16" x 2-1/4"	50	B55-0274	30.06
7/16" x 2-1/2"	50	B55-0280	27.92
7/16" x 3"	50	B55-0285	33.76
1/2" x 1-1/4"	25	B55-0290	11.23
1/2" x 1-1/2"	25	B55-0295	13.60
1/2" x 2"	25	B55-0300	15.08
1/2" x 2-1/2"	25	B55-0305	21.40
1/2" x 3"	25	B55-0310	23.12
5/8" x 2"	25	B55-0315	26.69
5/8" x 2-1/2"	25	B55-0320	25.22
5/8" x 3"	25	B55-0325	29.88
5/8" x 3-1/2"	25	B55-0330	40.33

• Sold in package quantities only.

## INDIVIDUAL BOLTS/NUTS

Size	Order No.	List
3/8" x 1"	A 484121	0.61
3/8" x 1-1/4"	A 527846	0.70
3/8" x 1-1/2"	A 484154	2.05
3/8" x 1-1/2" with 7/16" head	A 486449	0.61
3/8" x 2"	A 486498	0.61
7/16" x 1-1/4"	A 484089	0.62
7/16" x 1-1/2"	A 527853	1.02
7/16" x 1-3/4"	A 527812	1.10
7/16" x 2"	A 527796	0.96
7/16" x 3"	A 486225	1.19
1/2" x 2-1/2"	A 483719	1.86
1/2" x 3"	A 527838	1.07
5/8" x 3-1/2"	A 486258	2.54

## SPECIAL PLOW BOLTS

• Right Hand • Right hand, #3  
• Inventory Reducing • Grade 5  
• Nuts Included



Used on Plowshares, Landsides and More!

Size	Pkg. Qty.	Order No	List
3/8" x 1-1/2" w/7/16" Head	50	716381550P	31.82
7/16" x 2-1/2" w/1/2" Head	50	127162550P	34.88

## CLIPPED HEAD BOLTS - PLOWSHARES

• Right hand or left hand • Grade 5 • Nuts included



Size	Pkg. Qty.	Order No	List
7/16" x 1-1/4", RH	50	7161450C	36.82
7/16" x 1-1/4" LH	50	B55-0560	23.40
7/16" x 1-1/2", RH	50	B55-0515	25.36
7/16" x 1-3/4", RH	50	B55-0520	34.45
1/2" x 1-1/4", RH	25	B55-0525	15.03
1/2" x 1-3/8" LH	25	B55-0565	20.64
1/2" x 1-1/2", RH	25	B55-0530	15.16
16 mm x 35 mm Metric, RH	50	M16350C	65.89

## INDIVIDUAL CLIPPED HEAD BOLTS

Size With Nuts	Order No.	List
3/8" x 1-1/4"	A 527770	0.61
7/16" x 1-1/4"	A 527788	1.13
1/2" x 1-1/4"	A 483610	1.42

### Front Bolt

For Rock Share	Order No.	List
3/8" x 1-1/2"	A 483677	0.73
7/16" x 1-1/2"	A 527843	0.70
1/2" x 1-1/2"	A 527861	2.17

## PROTECTIVE PLOW COAT

A non-drying, low-gloss coating for use as temporary protection over tillage tools. Use on plow bottoms, disk blades, sweeps and shovels for protection against rust and corrosion. The soft coating will scour clean quickly when the implement is put into service. 12 oz. aerosol can.



Order No	List
A 972509	5.68

## ELLIPTICAL HEAD BOLTS

• Right Hand H10  
• Grade 5  
• Nuts Included



Size	Pkg. Qty.	Order No	List
3/8" x 1-1/2"	50	381550E	17.57

## CHROME PLATED PLOW BOLTS

• Right Hand



Size	Pkg. Qty.	Order No	List
1/2" x 1-1/2"	25	B55-0198	16.08

## MOUNTING CLIPS FOR SWEEPS

Install Clip Only Once When Using Quick Attach Style Sweeps.



C45-0408

C45-0607

C45-0610

Application	Bolt Size	Hole Spacing	Order No	List
Terminator Sweeps	7/16" Plow	1-3/4" to 2" Slotted. 47°	C45-0408	4.09
N Series Sweeps	7/16" Hex	1-3/4" 47 degree	C45-0607	4.20
N Series Sweeps	7/16" Hex	2" 47 degree	C45-0608	4.20
N Series Sweeps		Safety Spring	C45-0610	2.26

## MOLDBOARDS Made In The USA



- Heat-Treated
- Sold Individually
- Painted Black Finish
- 1080 High Carbon Steel
- Solid Construction, 5/16" thick
- Moldboards Require:  
(5) Grade 5 #3 Plow Bolts  
7/16" Dia. x 1" or 1-1/2 Long

Manufacturer	Models	Size	Mfg. No.	Order No.	List
Allis Chalmers	387 Series	14, 16", 18"	347966	M57-0356	159.39
DMI	Hydrawide	16", 18"	33111601	M57-0353	159.15
Ford	General Purpose	14"	104409	M57-0358	149.75
Ford	General Purpose	18"	R619-18HB	M57-0360	175.37
Harrell	Switch Plow	24"	7921736	A7901236	120.59
International	Super Chief (High Speed). Right Hand	16", 18"	462314R, 488265R, 58996C	M57-0352	148.95
International	Super Chief (High Speed). Left Hand	16", 18"	464603	464603	142.55
John Deere	HS314, HS324, HS354, HS434, HS444	14"	A20700	M57-0350	103.73
John Deere	HS316, HS326, HS356, HS436, HS446	16"	A20702	M57-0351	159.80
John Deere	NU-1048	18"	A17431	AA15673	175.37
John Deere	NU-1048. Left.	18"	A17432	AA15674L	175.37
John Deere	NU-450 (metric)	18", 20"	32209	A32209M	181.01
John Deere	Switch Plow	24"	P57264	A57264	74.56
Massey	"N", "N" Heavy Duty	16", 18"	660204M1, 660206M	660204	144.32
Melroe/Morris	General Purpose. Oliver Bottom	16", 18"	6522185-HB	M57-0353	159.15
Melroe/Morris	General Purpose. Left	16"	G522185L	L61916	146.09
Minneapolis	Nife line	16", 18"	20P42	M57-0353	159.15
Oliver/White	419-619 Series	14"	R419-14	M57-0354	143.77
Oliver/White	419-619 Series	16"	R419-16	M57-0353	159.15
Oliver/White	619 Series. Left	16"	R419-16L	L61916	146.09
Oliver/White	619 Series	18"	R619-18	M57-0360	175.37
Wilrich	General Purpose	16", 18"	6522185-HB, 215177, A4258	M57-0353	159.15

## PLOW SHINS - Bolts not included. See listing below for bolt ordering information.

Note:  
All Shins are right hand unless otherwise noted in the "Size" column. Hardware not included.  
Shins require (2) Grade 5, #3 Plow Bolts 7/16" x 1-1/4" or 1-1/2" long.

- Heat-Treated
- Sold Individually
- Painted Black Finish
- 1080 High Carbon Steel
- Hardware Not Included
- Solid Construction, 5/16" thick



Manufacturer	Models	Size	Bolt	Order No	List	Manufacturer's No.	Order No.	List
Allis Chalmers	387 Series	14, 16, 18"	3/8"	A 527846	0.70	347649	S30-0516	24.96
Baker	Switch Plow	18"	7/16"	A 484089	0.62	SB101	ASB101	26.92
DMI	Hydrawide - All	16", 18"	7/16"	A 484089	0.62	33111602	EP7490	18.35
Ford	General Purpose	12", 14", 16"				112136, 201344, 251435, 104428	104403A	16.44
Harrel	Switch Plow, Lower	18"				7920736	86CC	21.35
Harrel	Switch Plow, Upper	18"				9820736	A9820736	11.15
International	Super Chief. High Speed.	14, 16, 18"	7/16"	A 484089	0.62	488266R, 522325R	522325	19.44
International	Super Chief. High Speed. Left	14, 16, 18"	7/16"	A 484089	0.62	55075C	464595	17.73
John Deere	HS314, HS324, HS354, HS434, HS444, HS534, HS544	14"	7/16"	A 484089	0.62	A14700	8195A	21.12
John Deere	HS316, HS326, HS356, HS436, HS446, HS536, HS546, SD546	16"	7/16"	A 484089	0.62	A14702	8196AA	27.11
John Deere	NU-1036, NU-1046, NU-1048	16", 18"	7/16"	A 484089	0.62	A15594, A51081	A14883	20.29
John Deere	NU-1036, NU-1046, NU-1048. Left	16", 18"	7/16"	A 484089	0.62	A15606, A51082	A14887	25.32
John Deere	NU-400, NU-450 (metric)	All	7/16"	A 484089	0.62	A30129, A51080	A51080	29.51
John Deere	Switch Plow. Right	24"	7/16"			P57266	A57266	19.44
John Deere	Switch Plow. Left	24"	7/16"			P57265	A57265	19.60
Massey Ferguson	"N", "N" Heavy Duty	12, 14, 16, 18"	7/16"	A 484089	0.62	660008M91, 660020M1	660020	15.54
Melroe/Morris/Wilrich	General Purpose	16", 18"	7/16"	A 484089	0.62	6522182, 213032, A4257	EP7490	18.35
Melroe/Morris/Wilrich	General Purpose. Left	14", 16", 18"	7/16"	A 484089	0.62	6522182, 213032, A4257	217404L	26.17
Minneapolis Moline	Nife Line	14", 16"	7/16"	A 484089	0.62	7490	EP7490	18.35
National/David Brown	General Purpose	12", 14", 16	7/16"	A 484089	0.62	7490, HS105	EP7490	18.35
Oliver, Minneapolis	225, 425, 625, Nife line	12, 14, 16, 18"	7/16"	A 484089	0.62	EP7488C	EP7488	18.06
Oliver	219, 419, 519, 619, 719	12, 14, 16, 18"	7/16"	A 484089	0.62	EP7490C	EP7490	18.35
Oliver	219, 419, 519, 619, 719. Left	12, 14, 16, 18"	7/16"	A 484089	0.62	217404BS	217404L	26.17
Oliver	549, 588, 598, 619 (deep till bottom)	18, 20"	7/16"	A 484089	0.62	230381B	220381B	26.74

# TILLAGE

## LANDSIDES AND WEAR PADS

\*Bolts/Nuts included. See pages 130 - 132 for bolt sizes.  
Use #3 Head Plow bolts unless noted otherwise..



- 1/2" Thick
- Heat-Treated
- Sold Individually
- Painted Black Finish
- 1080 High Carbon Steel

Manufacturer	Model	Position	Type	Manufacturer's No.	Order No.	List
Baker	Switch Plow		LS	5B-102	ASB102	23.03
Baker	Short Switch Plow		LS	5B-103	ASB103	20.41
Ford	General Purpose (after 1958)	Front	LS	107980	107980*	33.32
Ford	General Purpose (after 1958)	Rear	LS	107981	107981	45.47
Harrel	Switch Plow. Front. 2-Hole	Small (4" x 6")	LS	79-010-36	A7920436	12.56
Harrel	Switch Plow. Rear. 4-Hole	Med (4" x 12")	LS	79-205-36	A7920536	25.63
International	Super Chief. 12-5/8" x 4-1/2" x 1/2"	Inner	-	59057, 1980672C2	L01-0100*	28.13
International	Super Chief. 6" x 4-1/2" x 1/2"	Outer	WP	59058C2	L01-0102*	14.16
International	Super Chief. 6" x 4-1/2" x 1/2"	RH & LH. Outer	WP	59058C1L	L01-0103*	13.94
International	Super Chief & Terra Flo	Front		522342R	522342	25.60
International	Super Chief & Terra Flo	Front. LH		522342L	522342L	26.80
John Deere	HS300, 400, 500, SDT, NU	Right	WP	AA15262, A16495 for 918011. Clipped head bolts.	A16493*	26.08
John Deere	HS300, 400, 500, SDT, NU	Left	WP	AA15263, A16496 for 1229565. Clipped head bolts.	AA15263L	18.13
John Deere	NU-400, NU-450 (metric)	-	WP	A27862, A45226	A27862*	37.49
John Deere	Switch Plow. 2-Hole	RH & LH Short	WP	A27862, A45226	A27862*	37.49
John Deere	Switch Plow. Front. 2-Hole	Front 1/2" x 4" x 6-1/2"	WP	P57046	A57046	11.85
John Deere			LS		A57052	23.55
John Deere	Switch Plow. Rear. 4-Hole.	.5" x 8" x 11.5"	LS	P57522	A57522	29.01
John Deere	Switch Plow. Rear. 3-Hole. 995 & 975	Rear. Large	LS	P60071	A60071	31.92
Massey Ferguson	"N" Heavy Duty, High Speed	Front	Inner	475153M1	495937*	43.90
Melroe	General Purpose	Medium. 15"	LS	6526000	L01-0151*	42.30
Melroe	6252600	Reversible	WP	6526852	L01-0152*	24.96
Oliver	419, 425, 619, 619 slat, 625	Old offset	LS	218270B	L01-0180*	40.54
Wilrich	General Purpose. Solid Inner Plate	15-7/16"x4-1/2"x9/16"	LS	215111, A4253	L01-0250*	38.79
Wilrich	General Purpose. 2-Hole	4-1/2" x 5-7/8"	WP	215225, A4256	L01-0251*	26.82

## PLOWSHARES - RIBBED

Bolts not included. Plow shares are guaranteed against breakage for 1/2" of wear through the width of the plow share. Use Clipped Head bolts listed on page 148.

Made In The USA



- 3/8" Thick
- Heat-Treated
- Painted Black Finish
- 1080 High Carbon Steel
- Hardware Not Included
- Sold In Cartons of 6 Only, except Baker

Get the  
**Adams Edge.**

Manufacturer	Model	Size	Bolt Size	Mfg. No.	Order No.	List
Allis Chalmers	387 Series 4-hole	14, 16"	(1)1/2", (3)7/16"	347749, 347750, 347751, 572181,	AM164RS	22.92
Allis Chalmers	387 Series 4-hole	18"	(1)1/2", (3)7/16"	573307, 347752	AM184RS	24.47
					AM184RSH*	71.64
Baker	Switch Plow	18'	(6) 1/2"	SB100	BA256RS	29.18
Baker	Switch Plow. Hardfaced Front Side	18"	(6) 1/2"	SB100	BA256RSHFS	94.15
Case	EX A, B, C, D, E 3 & 4-hole	16"	(1)1/2", (3)3/8"	T39134, T39135, T39136	CA164RSH*	53.16
Case	EX A, B, C, D, E 4-hole	16"	7/16"	T63194, T63195, RCase6R	OM164RS	22.92
Case	EX A, B, C, D, E 5-hole	18"	7/16"	RCase8R, T89974, T63097, T63133, T63206-RA18R	OM185RS	24.47
Ford	General Purpose 3-hole	12"	7/16"	105203A	FF123R5	24.47
Ford	Heavy Duty 3 & 4-hole	14"	7/16"	7100369, 201573, 201579, 201585, 201586	FF144RS	22.33
Ford	Heavy Duty 3 & 4-hole	16"	7/16"	7100370, 201575, 201581, 201587, 201588	FF164RS	22.92
Ford	Heavy Duty 5 hole	18"	7/16"	7101980, 201589, 201596	FF185RS	24.47
Ford	Heavy Duty 5 hole. Left Hand	18"	7/16"	7101980, 201589, 201596	FF185LRS	24.47
Ford	150, 151, 152, 154 4-hole	16"	7/16"	SBP219627BF, 215427DS	OM164RS	22.92
Ford	150, 151, 152, 154 4-hole short	16"	7/16"	SBP219627BF, 215427DS	OM164RS	22.92
Ford	150, 151, 152, 154 5-hole	18"	7/16"	SBP219629BF, 251565DS	OM185RS	24.47
Harrell	Switch Plow	18"	(5)7/16"	7900636	HA245RS	23.80
Harrell	Switch Plow. Hardfaced Back Side	18"	(5)7/16"	7900636	HA245RSHBS	80.06

\*Hardfaced



**PLOWSHARES - RIBBED**

Bolts not included. Plow shares are guaranteed against breakage for 1/2" of wear through the width of the plow share. Bolts are listed on page 148.



Get the **Adams Edge™**

- 3/8" Thick
- Heat-Treated
- Painted Black Finish
- 1080 High Carbon Steel
- Hardware Not Included
- Sold In Cartons of 6 Only, except Baker

Made In The USA

Manufacturer	Model	Size	Bolt Size	Mfg. No.	Order No.	List
International	Super Chief 4 hole short. Left hand	16"	(1)1/2", (3)7/16"	143241R1, 462223R11, 462227R11, 463241R1, 463233R1, 463253R1, 463237R1, 470957R1	IH164LRS	22.92
					IH164LRSH*	51.91
International	Super Chief 4 hole short	16"	(1)1/2", (3)7/16"	143241R1, 462223R11, 462227R11, 463241R1, 463233R1, 463253R1, 463237R1, 470957R1	IH164RS	22.92
					IH164RSH*	61.07
International	Super Chief 4-hole	16"	(1)1/2", (3)7/16"	462223R11, 462227R11, 463241R1, 463233R1, 463253R1, 463237R1, 470957R1	IH164RS	22.92
					IH164RSH*	61.07
International	Super Chief 4-hole. Left Hand. Inserted	18", 20"	(1)1/2", (3)7/16"	463254R, 463238R, 481960R1, 481964R1, 492081R1, 481961R1, 481965R1	IH184LRS	24.47
					IH184LRSH*	64.63
					IH184LRSH76	82.57
International	Super Chief 4-hole Inserted	18", 20"	(1)1/2", (3)7/16"	463254R, 463238R, 481960R1, 481964R1, 492081R1, 481961R1, 481965R1	IH184RS	24.47
					IH184RSH*	24.47
					IH184RSH76	24.47
John Deere	HS350, 400, 500, SDJ & NU Series 4-hole	14"	(1)1/2", (3)7/16"	A10225, A10222, A10226, A14221, A14222, A14225, A14226, A14321, A14322, A14025, A10325, A10326, A51498, A10221	JD144RS	22.33
John Deere	HS350, 400, 500, NU 4-hole short	14"	(1)1/2", (3)7/16"	A10225, A10222, A10226, A14221, A14222, A14225, A14226, A14321, A14322, A14025, A10325, A10326, A51498, A10221	JD144RS	22.33
John Deere	HS356, 400, 500, SDT, NU Series 4-hole. Left Hand.	16"	(1)1/2", (3)7/16"	A10227, A10224, A10228, A10327, A10323, A10324, A10328, A14027, A51500, A10223	JD164LRS	22.92
John Deere	HS356, 400, 500, SDT, NU 4-hole	16"	(1)1/2", (3)7/16"	A10227, A10224, A10228, A10327, A10323, A10324, A10328, A14027, A51500, A10223	JD164RS JD164RSH*	22.92 61.07
John Deere	HS356, 400, 500, SDT, NU 4-hole short	16"	(1)1/2", (3)7/16"	A10227, A10224, A10228, A10327, A10323, A10324, A10328, A14027, A51500, A10223	JD164RS JD164RSH*	22.92 61.07
John Deere	NU-1048 5-hole. Left Hand.	18, 20"	(4)7/16", (1)1/2"	A51506	JD185LRS JD185LRSH*	24.47 64.62
John Deere	NU-1048 5-hole	18, 20"	(4)7/16", (1)1/2"	AA51504	JD185RS	24.47
					JD185RSH*	64.63
John Deere	NU 450 (metric) 3-hole	18"	7/16"	A42808, A30951, A42807, A32222, A40408, A32221, A40407, A32217	JD183RS	24.47
					JD183RSH*	64.63
John Deere	Switch Plow	18"	(4)7/16"	P59129	JD244RS	23.80
John Deere	Switch Plow. Hardfaced Back Side	18"	(4)7/16"	P59130	JD244RSHBS	80.06
John Deere	Switch Plow. Hardfaced Front Side	18"	(4)7/16"	P59130	JD244RSHFS	80.06
Long	Switch Plow	18"	(5)7/16"	792800	LO245RS	29.18
Massey	"N" Heavy Duty 4-hole	16"	1/2"	475716M1, 475161M1	MF164RS	22.92
Massey	"N" Heavy Duty 4-hole. Left Hand.	18"	1/2"	475823M1	MF184LRS	24.47
					MF184LRSH*	60.11
Massey	"N" Heavy Duty 4-hole.	18"	1/2"	475823M1	MF184RS	24.47
Melroe/Morris	387 Series. Drop Front Hole. 4-hole.	16"	(1) 1/2", (3)7/16"	347749, 572184	AM164RS	22.92
Melroe/Morris	387 Series. Inline Hole. 4-hole.	16"	(1) 1/2", (3)7/16"	6527052	MR164RS	22.92
Melroe/Morris	387 Series. Drop Front Hole. 4-hole.	18"	(1) 1/2", (3)7/16"	573307	AM184RS	24.47
					AM184RSH*	71.64
Melroe/Morris	Star GP. 4-hole.	14"	(1) 1/2", (3)7/16"	6526827	MM144RS	19.81
Melroe/Morris	Star GP. 4-hole.	16"	(4)7/16"	6526832	MM164RS	22.92
Melroe/Morris	Star GP. 4-hole.	18"	(4)7/16"	6526829	MM184RS	22.92

\*Hardfaced

# TILLAGE

## PLOWSHARES - RIBBED

Bolts not included. Plow shares are guaranteed against breakage for 1/2" of wear through the width of the plow share. Bolts are listed on page 148.

Made In The USA

Get the  
**Adams Edge™**



- 3/8" Thick
- Heat-Treated
- Painted Black Finish
- 1080 High Carbon Steel
- Hardware Not Included
- Sold In Cartons of 6 Only, except Baker

Manufacturer	Model	Size	Bolt Size	Mfg. No.	Order No.	List
Oliver/White	619, 625, 719, 819, 434	16"	(1) 1/2", (3) 7/16"	RCA6R, 219617BS	OC164RS	22.92
Oliver/White	619, 625, 719, 819, 434	18"	(1) 1/2", (4) 7/16"	RCA8R, 219619BS	OC185LRS	24.47
Case	3 & 4-hole. Left Hand.				OC185LRSH*	64.63
Oliver/White	619, 625, 719, 819, 434	18"	(1) 1/2", (4) 7/16"	RCA8R, 219619BS	OC185RS	24.47
Case	3 & 4-hole.				OC185RSH*	64.63
Oliver/White	619, 625, 719, 819, 434			RB14R, 219615BS, HD14FCO, RCase4S,	OM144RS	22.33
Case	3 & 4-hole, Nife line	14"	7/16"	220013BS, RCase4R,	OM144RSH*	61.75
Oliver/White	619, 625, 719, 819, 434			RB14R, 219615BS, HD14FCO, RCase4S,	OM144RS	22.33
Case	3 & 4-hole short	14"	7/16"	220013BS, RCase4R	OM144RSH*	61.75
Oliver/White	619, 719, 819, 919, 625,	16"	7/16"	RB16R, HD16FCO, 219617BS, RCase6S,	OM164LRS	22.92
Case	434 3 & 4-hole. Left Hand.			220016BS, RCase6R		
Oliver/White	619, 719, 819, 919, 625,	16"	7/16"	RB16R, HD16FCO, 219617BS, RCase6S,	OM164RS	22.92
Case	434 3 & 4-hole, Nife line			220016BS, RCase6R	OM164RSH*	61.07
Oliver/White	619, 719, 819, 919, 625,			RB16R, HD16FCO, 219617BS, RCase6S,	OM164RS	22.92
Case	434 3 & 4-hole short	16"	7/16"	220016BS, RCase6R	OM164RS	61.07
Oliver/White	619, 719, 819, 919, 625,			RA18R, 219619BS, HD18FCO, RCase8R,	OM185RS	24.47
Case	434 5-hole	16, 18, 20"	7/16"	220024BS, RCase8S	OM185RSH*	64.63
	Left hand				OM185LRS	24.47
Watts	All. 4-Hole. Left Hand.	All	7/16"	FO25	WA184LRS	24.47
Wilrich	GP. 4-Hole	18	1/2"	14255, 215806, 16047	WR184RS	24.47
					WR184RSH	64.61

\*Hardfaced

## SHARES - UPSET FORGED

Right handed, unless noted.



- 3/8" Thick
- Heat-Treated
- Painted Black Finish
- Sold In Cartons of 6 Only
- Long Wearing, High Carbon Steel

Manufacturer	Model	Size	Bolt Size	Mfg. No.	Order No.	List
Allis Chalmers	387 Series. 4-Hole	16"	(1) 1/2" x 1-1/2", (3) 7/16" x 1-3/16"	347750	S26-0509	46.99
Case	EX A, B, C, D, E. 4-Hole	16"	(1) 1/2" x 1-1/4", (3) 7/16" x 1-3/16"	T39135	S26-0518	35.70
International	Super Chief. 4-Hole	16"	(1) 1/2" x 1-3/8", (3) 7/16" x 1-1/4"	463237R1, 463241R1, 464343R1	S26-0141	29.79
International	Super Chief. 4-Hole	18"	(1) 1/2" x 1-3/8", (3) 7/16" x 1-1/4"	463238R1	S26-0142	33.16
John Deere	HS350, 400, 500, NU. 4-Hole	14"	(1) 1/2" x 1-3/8", (3) 7/16" x 1-3/4"	A10225, A10221, A10222, A10226	S26-0056	34.02
John Deere	HS350, 400, 500, SDT, NU. 4-Hole	16"	(1) 1/2" x 1-1/4", (3) 7/16" x 1-3/16"	A10227, A10223, A10224, A10228	S26-0058	29.79
John Deere	NU Bottoms. 4-Hole	18"	(1) 1/2" x 1-1/4", (3) 7/16" x 1-3/16"	A14243, A14224	S26-0060	38.24
John Deere	NU 450 Metric. 3-Hole	18"	(3) M16 x M35	A42808, A30951	S26-0452	39.05
Melroe	General Purpose 992. 4-Hole	18"	(4) 7/16" x 1-1/4"	6526829	S26-0203	38.24
Oliver/White	619, 625, 718, 819 & 434. 4-Hole	14" Hvy Curved	(1) 1/2" x 1-3/8", (3) 7/16" x 1-1/4"	219615BS, RCA4R, RCA4S	S26-0251	34.02
Oliver/White	619, 625, 718, 819 & 434. 4-Hole	16" Hvy Curved	(1) 1/2" x 1-3/8", (3) 7/16" x 1-1/4"	219615BS, RCA4R, RCA4S	S26-0302	29.79
Oliver/White	619, 625, 718, 819 & 434. 5-Hole	18" Hvy Curved	(1) 1/2" x 1-3/8", (4) 7/16" x 1-1/4"	219615BS, RCA4R, RCA4S	S26-0253	39.81
Oliver/White	619, 625, 718, 819 & 434. 5-Hole	18" LH Hvy Curved	(1) 1/2" x 1-3/8", (4) 7/16" x 1-1/4"	219615BS, RCA4R, RCA4S	S26-0254	38.24
Wilrich	General Purpose. 4-Hole	18"	(4) 1/2" x 1-3/8"	215806, A4255	S26-0350	33.16

## COULTERS - WAVY

Replaces Number	Application	Diam.	No. Waves	Wave Width	Gauge	Center Hole	Bolt Hole	Bolt Circle	Order Number	List
A72678	JD Max Emerge 2, Plus, Pro, XP, XP Pro, ME5, Exact Emerge	16"	12	3/4"	.185"	2.125"	5) .510"	4.75"	B45-1122	26.11
	JD Max Emerge	16"	12	3/4"	.185"	2.015" Slotted	6) 4.06" x .469" & 3.375"	3.5"	B45-1123	26.11
D7803-12	Kinze	15-13/16"	12	3/4"	.177"	3.984"	4) .531"	5.25"	B45-1124	25.68
A73911	JD Max Emerge	16"	8					3.5"	B45-1125	43.96
	JD Max Emerge	16"	24					3.5"	B45-1126	54.72
820-082C	Great Plains, White, Yetter	17"	12	3/4"	.157"	3.97"	4) .531"	5.25"	B45-1120	29.22
55-318	Tye, DMI, Melroe, United Farm Tool Wilrich	17-5/8"	12	3/4"	.168"	3.640"	4) .531"	5.0"	B45-1121	28.19
AL573885	AC	17-7/8"	8	1"	.170"	1.81"	6) .406"	3.25"	B45-1165	39.62

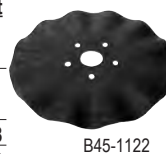

B45-1122

## COULTERS - FLUTED / RIPPLED

Replaces Number	Application	Diam.	Gauge	Center Hole	Bolt Hole	Bolt Circle	Order Number	List
820-018C	Great Plains Yetter	17"	.138"	3.97"	4) .531"	5.25"	B45-1135	26.78
FL179IH	IH	17"	.157"	.968"x1.344" Slot	6) .344"	3.25"	B45-1180	41.62
FL207OL	White	20"	.177"	4.0"	4) .531"	5.25"	B45-1183	36.75
N/A	DMI/Blue Jet	20"	7 GA	3-11/16"	8) .531"	5 & 5-1/4"	B45-1140	48.54
	JD, Pioneer	17"	.157"	4"	4) .5"	2.5"	B45-1704	36.30
	White Horse	17"	.187"	2"	6) 7/16"	3.5"	B45-1735	35.94

B45-1135



## COULTERS - PLAIN / FLAT

Replaces Number	Application	Diam.	Thickness	Center Hole	Bolt Hole	Bolt Circle	Order Number	List
N214190	JD 750, 1850, 1560, 1690, 1860	18"	.203"	3.031"	4) .406"	4.375"	B45-3049	32.88
N283804	No Till Grain Drills 1890, 1895, 1990							
N283804	JD Drill Disc Opener	18"	.023"(5MM)		4	4.375"	B45-3049F	45.05
19-4500-1-2	Buffalo	18"	.157"	2.25"	6) .390"	3.75"	B45-1185	40.27
F205112S	Brilliant & Others	20"	5 GA	1.56" Sq.	N/A	N/A	B45-1150	53.49
306001A	CNH Opener, Air Seeders	22.5"	.256"		4		B45-3165F	73.58
F205112R	Glencoe & Others	20"	5 GA	1.56" Rd.	N/A	N/A	B45-1160	48.54
F225112R	Glencoe & Others	22"	5 GA	1.56" Rd.	N/A	N/A	B45-1162	68.54
	AC, Krause Chisel Plows	20.5"	3/16"	1.5" Rd.	N/A	N/A	2036	47.39

2036



## COULTERS - BUBBLE

Replaces Number	Application	Diam.	Gauge	Center Hole	Bolt Hole	Bolt Circle	Order Number	List
AC595266	AC	16-13/16"	.160"	1.81"	6) .460"	3.25"	B45-1170	34.57
A22336, A24947, A73910	JD, 16", A24997 Kinze, 16", 24-3112	17"	.160"	2.00"	6) .406" x .469"	3.375" & 3.50	B45-1173	36.77

B45-1170



## COULTER - CONCAVE

Fits Buffalo. Replaces 3-4400-17.  
 Diameter: 14"  
 Gauge: .157"  
 Center Hole: 2.81"  
 Bolt Holes: 4  
 Bolt Hole Size: .406"  
 Bolt Circle: 4"

Order No. List  
 B45-1186 26.49



## FERTILIZER COULTERS

8 Bolt holes. 3-11/16" center hole.  
 5" and 5.25" bolt circle. Bolt hole size is .5313.



Description	Diameter	Thickness	Order No.	List
Crucible Fluted	20" x 4.5mm	.177"	B45-1130	35.47

## COULTER - 8 WAVE

23" DIAMETER  
 6.5MM THICK  
 2" HOLE SIZE  
 8.66" FLAT CENTER



Application	OEM	Order No.	List
Summers Super Coulters & Super Coulters Plus.	8J1021N	B45-1021F	94.86
SC1510, SC1030, SC1530, SC1535, SC1550, SC1556			

## STANDARD CONCAVITY, SOLID EDGE



**Gauge To Inch Conversion:**

12 Gauge	=	.104" (2.6 mm)
11 Gauge	=	.119" (3 mm)
10 Gauge	=	.134" (3.4 mm)
9 Gauge	=	.149" (3.8 mm)
8 Gauge	=	.164" (4.2 mm)
7 Gauge	=	.179" (4.5 mm)
6 Gauge	=	.194" (5 mm)
5 Gauge	=	.209" (5.3 mm)
4 Gauge	=	.224" (5.7 mm)
3 Gauge	=	.236" (6 mm)

- Popular Sizes & Gauges Available
- Boron Steel, Accurately Hardened.
- Dual Punch Centers for Inventory Reduction.
- Precision Double Bevel for Superior Penetration.
- Backed by Herschel Warranty for Quality and Workmanship.

Diam.	Gauge	Hole Size	Concavity	Order No	List
16"	11 GA	7/8" Sq. x 1" Sq.	1-1/2"	B45-2001	19.74
16"	11 GA	7/8" Sq. x 1" Rd.	1-1/2"	B45-2007	20.17
16"	11 GA	1" Sq. x 1-1/8" Sq.	1-1/2"	B45-2003	19.74
16"	11 GA	1-1/8" Sq.	1-1/2"	B45-2009	20.17
18"	6 GA	1-1/8" Sq.	1-3/4"	B45-2140	38.09
18"	9 GA	7/8" Sq. x 1" Rd.	1-3/4"	B45-2030	24.95
18"	9 GA	1" Sq. x 1-1/8" Sq.	1-3/4"	B45-2024	24.94
18"	9 GA	1-1/8" Sq.	1-3/4"	B45-2028	24.94
18"	9 GA	1-1/8" Sq. x 1-1/4" Sq.	1-3/4"	B45-2025	24.94
18"	9 GA	1-1/4" Sq. x 1-1/2" Rd.	1-3/4"	B45-2023	24.94
18"	7 GA	1-1/8" Sq.	1-3/4"	B45-2181	27.31
18"	7 GA	1-1/8" Sq. x 1-1/4" Sq.	1-3/4"	B45-2015	29.36
18"	9 GA	7/8" Sq. X 1" Sq	1-3/4"	B45-2243	24.94
20"	6 GA	1-1/8" Sq.	2-1/4"	B45-2142	43.46
20"	7 GA	1" Sq x 1-1/8" Sq	2-1/4"	B45-2040	33.80
20"	7 GA	1-1/8" Sq.	2-1/4"	B45-2043	33.80
20"	7 GA	1-1/8" Sq. x 1-1/4" Sq.	2-1/4"	B45-2042	33.80
20"	7 GA	1-1/4" Sq. x 1-1/2" Rd.	2-1/4"	B45-2044	33.80
20"	7 GA	1-1/2" Sq. x 1-3/4" Rd.	2-1/4"	B45-2045	33.80
20"	9 GA	1" Sq. X 1-1/8" Sq	2-1/4"	B45-2139	30.18
22"	7 GA	1-1/8" Sq. x 1-1/4" Sq.	2-1/2"	B45-2052	41.84
22"	7 GA	1-1/4" Sq. x 1-1/2" Rd.	2-1/2"	B45-2048	41.84
22"	7 GA	1-1/2" Sq. x 1-3/4" Rd.	2-1/2"	B45-2049	41.84
22"	7 GA	2" Rd.	2-1/2"	B45-2238	44.16
22"	6 GA	1-1/8" Sq. x 1-1/4" Sq.	2-1/2"	B45-2145	46.33
22"	6 GA	1-1/8" Sq.	2-1/2"	B45-2149	46.33
22"	1/4"	1-1/8" Sq. x 1-1/4" Sq.	2-1/2"	B45-2100	60.66
22"	1/4"	1-1/4" Sq. x 1-1/2" Rd.	2-1/2"	B45-2107	60.66
22"	1/4"	1-1/2" Sq. x 1-3/4" Rd.	2-1/2"	B45-2105	60.66
22"	1/4"	1-1/8" Sq	2-1/2"	B45-2111	70.85
22"	1/4"	2" RD		B45-2087	70.85
22"	7 GA	1-1/8" Sq.	2-1/2"	B45-2196	41.84
22"	6 GA	1-1/2" Rd.	2-1/2"	B45-2242	46.33
22"	1/4"	2-5/16" Rd.	2-1/2"	B45-2247	60.66
24"	1/4"	1-1/8" Sq. x 1-1/4" Sq.	3-1/4"	B45-2070	70.85
24"	1/4"	1-1/4" Sq. x 1-1/2" Rd.	3-1/4"	B45-2074	70.85
24"	1/4"	1-1/2" Sq. x 1-3/4" Rd.	3-1/4"	B45-2075	70.85
24"	1/4"	1-1/2" Sq.	3"	B45-2160	70.85
24"	1/4"	1-1/2" Rd.	3"	B45-2117	70.85
24"	1/4"	1-1/8" Sq.	3-1/4"	B45-2113	70.85
24"	1/4"	2 Rd.	3-1/2"	B45-2109	70.85
24"	5/16"	1-1/2" Sq. x 1-3/4" Rd.	3-1/4"	B45-2265	107.30
24"	1/4"	1-3/4" RD	3-1/4"	B45-2115	70.85
26"	1/4"	1-1/2" Sq. x 1-3/4" Rd.	3-1/2"	B45-2120	76.52
26"	1/4"	1-1/2" Rd.	3-1/2"	B45-2252	76.52
26"	1/4"	2 Rd.	3-1/2"	B45-2091	76.52

## STANDARD CONCAVITY, NOTCHED EDGE



**Gauge To Inch Conversion:**

12 Gauge	=	.104" (2.6 mm)
11 Gauge	=	.119" (3 mm)
10 Gauge	=	.134" (3.4 mm)
9 Gauge	=	.149" (3.8 mm)
8 Gauge	=	.164" (4.2 mm)
7 Gauge	=	.179" (4.5 mm)
6 Gauge	=	.194" (5 mm)
5 Gauge	=	.209" (5.3 mm)
4 Gauge	=	.224" (5.7 mm)
3 Gauge	=	.236" (6 mm)

- Popular Sizes & Gauges Available
- High Carbon Steel, Accurately Hardened.
- Dual Punch Centers for Inventory Reduction.
- Precision Double Bevel for Superior Penetration.
- Backed by Herschel Warranty for Quality and Workmanship.

Diam.	Gauge	Hole Size	Concavity	Order No	List
16"	11 GA	7/8" Sq. x 1" Sq.	1-1/2"	B45-2002	20.17
16"	11 GA	1" Sq. x 1-1/8" Sq.	1-1/2"	B45-2004	20.17
18"	7 GA	1-1/8" Sq. x 1-1/4" Sq.	1-3/4"	B45-2016	30.73
18"	7 GA	1-1/8" Sq.	1-3/4"	B45-2233	30.73
18"	9 GA	7/8" Sq. x 1" Sq.	1-3/4"	B45-2244	26.22
18"	9 GA	7/8" Sq. x 1" Rd.	1-3/4"	B45-2244	26.22
18"	9 GA	7/8" Sq. x 1" Rd.	1-3/4"	B45-2027	26.22
18"	9 GA	1" Sq. x 1-1/8" Sq.	1-3/4"	B45-2021	26.22
18"	9 GA	1-1/8" Sq. x 1-1/4" Sq.	1-3/4"	B45-2026	26.22
18"	1/4"	1-1/2" Sq.	1-3/4"	B45-2018	38.31
20"	7 GA	7/8" Sq. x 1" Rd.	2-1/4"	B45-2061	34.37
20"	7 GA	1" Sq. x 1-1/8" Sq.	2-1/4"	B45-2041	34.37
20"	7 GA	1-1/8" Sq.	2-1/4"	B45-2199	34.37
20"	7 GA	1-1/8" Sq. x 1-1/4" Sq.	2-1/4"	B45-2046	34.37
20"	7 GA	1-1/4" Sq. x 1-1/2" Rd.	2-1/4"	B45-2047	34.38
20"	7 GA	1-1/8" Sq.	2-1/4"	B45-2199	34.37
20"	1/4"	1-1/2" Sq.	1-3/4"	B45-2020	49.26
22"	7 GA	1-1/8" Sq.	2-1/2"	B45-2203	44.71
22"	7 GA	1-1/8" Sq. x 1-1/4" Sq.	2-1/2"	B45-2051	44.71
22"	7 GA	1-1/4" Sq. x 1-1/2" Rd.	2-1/2"	B45-2055	44.71
22"	7 GA	1-1/2" Sq. x 1-3/4" Rd.	2-1/2"	B45-2056	44.71
22"	6 GA	1-1/8" Sq.	2-1/2"	B45-2147	46.67
22"	6 GA	1-1/8" Sq. x 1-1/4" Sq.	2-1/2"	B45-2148	46.67
22"	6 GA	1-1/2" Sq. x 1-3/4" Rd.	2-1/2"	B45-2146	46.67
24"	1/4"	1-1/8" Sq. x 1-1/4" Sq.	3-1/4"	B45-2071	71.46
24"	1/4"	1-1/4" Sq. x 1-1/2" Rd.	3-1/4"	B45-2076	71.46
24"	1/4"	1-1/2" Sq. x 1-3/4" Rd.	3-1/4"	B45-2077	71.46
24"	1/4"	1-1/2" Sq.	3-1/4"	B45-2078	71.46
26"	1/4"	1-1/2" Sq. x 1-3/4" Rd.	3-1/2"	B45-2122	79.79
26"	5/16"	1-1/2" Sq. x 1-5/8" Rd.	3-1/2"	B45-2228	109.47

Additional Sizes Available.  
Call Customer Service To Order!

## CONE STYLE, SOLID EDGE - JD

3.87" Concavity



Diam.	Thickness	Hole Size	Order No.	List
20"	7 GA	1-1/8" Sq. x 1-1/4" Sq.	B45-2097	34.35
22"	7 GA	1-1/8" Sq. x 1-1/4" Sq.	B45-2098	41.84
24"	1/4"	1-1/2" Sq.	B45-2072	71.46
26"	1/4"	1-1/4" Sq. 4-3/4" Concavity	B45-2123	76.52
26"	1/4"	1-1/2" Sq. 4-3/4" Concavity	B45-2119	76.52

## CONE STYLE, NOTCHED EDGE - JD

3.87" Concavity



Diam.	Thickness	Hole Size	Order No.	List
22"	7 GA	1-1/8" Sq. x 1-1/4" Sq.	B45-2099	49.49
24"	1/4"	1-1/2" Sq.	B45-2073	71.46
26"	1/4"	1-1/4" Sq. 4-3/4" Concavity	B45-2124	79.79
26"	1/4"	1-1/2" Sq. 4-3/4" Concavity	B45-2121	79.79

**FLAT CENTER STYLE, SOLID EDGE - IH**

2" Concavity

B45-2092



Diam.	Thickness	Hole Size	Order No.	List
20"	7 GA	1-1/8" Sq.	B45-2092	33.80
22"	7 GA	1-1/8" Sq.	B45-2094	41.84
22"	6 GA	1-1/8" Sq.	B45-2159	46.33
22"	6 GA	1-1/2" Sq.	B45-2250	46.33
22"	1/4"	1-1/2" Rd	B45-2266	60.66
24"	1/4"	1-1/2" Sq.	B45-2096	70.85
24"	1/4"	1-1/8" Sq. x 1-1/4" Sq	B45-2259	70.84
26"	1/4"	1-1/2" Sq.	B45-2261	76.52

**FLAT CENTER STYLE, NOTCHED EDGE - IH**

2" Concavity

B45-2093



Diam.	Thickness	Hole Size	Order No.	List
20"	7 GA	1-1/8" Sq.	B45-2093	34.38
22"	7 GA	1-1/8" Sq.	B45-2095	46.67
22"	6 GA	1-1/8" Sq.	B45-2158	46.67
22"	6 GA	1-1/2" Rd.	B45-2251	46.67
26"	1/4"	1-1/8" Sq.	B45-2258	77.90

**SPECIAL CONCAVITY, NOTCHED EDGE**

Miller and New Holland

B45-2082

Front disc blade. 2-5/8" concavity



Diam.	Thickness	Size	Order No.	List
24"	1/4"	1-1/2" Sq. x 1-3/4" Rd.	B45-2082	70.75

**HOULE MANURE BLADE**

Fits 22" Concave Disc Incorporator

Plain Edge Concave Blade

3.5" Center Hole

6 Mounting Holes

OEM	Thickness	Order No	List
18-75-0172A	7 Gauge	B45-2735	48.21

# TILLAGE

## HARRELL CROP CHOPPERS

- OEM Quality
- 3/8" Heat Treated High Carbon Steel
- (4) .7" x 1.65" Bolt Holes

Size	Replaces	Order No	List
24"	HA9301175	B45-2324	53.95
36"	HA9300575	B45-2336	75.57
38"	HA9300775	B45-2338	78.02

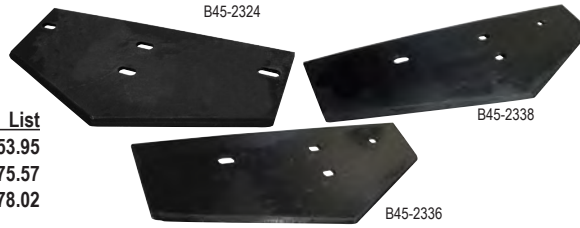

## COTTON STALK PULLER/CHOPPER BLADES

Replacement Blade Only with 12 Welded Cleats, 1/4" x 3" x 3". Fits Besler & Sundance. Replaces PP28 and SC7. 27-3/8" diameter. 1/4" Thick.

Center Hole	Bolt Hole	Bolt Circle	Order Number	List
4.688"	.515" (6)	6"	B45-2300	147.13



Fits Amadas Cotton Stalk Choppers. 20" Long 8" wide at point 5" wide at ends 3/8" thick with (3) 1/2" slotted mounting holes. Replaces 61517.

Order Number	List
B45-2320	35.16



## VERTICAL TILLAGE

### SAMURAI EDGE - 24 WAVE

The Samurai Edge excels on high speed vertical tillage because it uniquely sizes the residue back into the soil. Its design also stays sharp longer and positively turns with the tractor which decreases fuel consumption.



Application	Concavity	Diameter	Thickness	Hole Size	# Of Bolt Holes	Bolt Hole Size	Circle	Order No.	List
Great Plains, Yetter, Salford, White, DMI, etc.	1.75"	18"	5 mm	4"	4	.531"	5" & 5.25"	B45-4009	58.16
CNH 330 Turbo & other CNH machines. Raised Flat Center	1.75"	20"	6 mm	1.25 S x 1.5 R				B45-4002	82.27
John Deere, Krause, Landoll, Sunflower, etc.	1.75"	20"	5 mm	1.5 S x 1.75 R				B45-4011	66.32
John Deere, Krause, Landoll, Sunflower, etc.	2"	22"	6 mm	1.5 S x 1.75 R				B45-4005	92.64
Various Vertical Tillage Equipment	1.75"	20"	5 mm	1.125 S x 1.25 S				B45-4003	62.51
Various Vertical Tillage Equipment	2"	22"	5 mm	1.125 S x 1.25 S				B45-4006	76.48

### VERTICAL TILLAGE BLADES - 24 WAVE

- Excellent Crop Residue/Soil Mixing
- Made of Boron Steel For Long Life



Application	Concavity	Diameter	Thickness	Hole Size	Bolt Order No.	List
CNH 330 Turbo & other CNH machines. Raised Flat Center	1.75"	20"	6 mm	1.25 S x 1.5 R	B45-4001	75.96
John Deere, Krause, Landoll, Sunflower, etc.	2"	22"	6 mm	1.5 S x 1.75 R	B45-4016	86.32

### VERTICAL TILLAGE BLADES

- Great Soil Mixing Action
- Made of Boron Steel For Long Life

Flat Blade. 20" Diameter. 5 mm thickness.

Fits Various Vertical Tillage Equipment

# Of Waves	Hole Size	Order No.	List
13	1.5 S x 1.75 R	B45-4022	46.72
13	1.125 S x 1.25 S	B45-4024	46.72

### VERTICAL TILLAGE BLADES - 8 WAVE

2" Wave

Application	OEM	Diameter	Thickness	Hole Size	# Of Bolt Holes	Bolt Hole Size	Bolt Circle	Order No.	List
Salford. 450RTS, 470RTS, I-1100, I-1200, I-1500	CT512208	20"	4.5MM	4"	4	.5	5" & 5.25"	B45-2731F*	49.55
Salford 575RTS, I-2100, I-2200, I-4100, I-4200	CT512208	22"	5MM	4"	5	.5	5.5"	B45-2732F*	57.62

# TILLAGE

## DEEP TILLAGE BLADES - Salford/DMI

Fits Salford, DMI, Etc.

- 2.5" Concavity
- 6.5MM 5-Bolt 4-1/8" Center
- 5.5" Bolt Circle
- .562" Bolt Holes



Size	OEM	Order No	List
24"	CT503059	B45-2738F	77.87

## 6.5MM DISC BLADE - WISHEK, HORSCH JOKER

Application	OEM	Diameter	Hole Size	Holes	# Of Bolt Hole Size	Bolt Circle	Bolt Order No.	List
Wishek. Several Discs		26"	2" R				B45-2734F	83.67
Horsch-Anderson Joker. Notched. Flat center no hole.	04559503	20"	4.2"	5	.5	5" & 5.25"	B45-2740	67.56

## COULTER BLADES - UNVERFERTH

Forges NX200 France Made Blades  
Lifetime Guarantee Against Breakage  
3.84" Center Hole  
6 Bolt Holes 3/8" Diameter On 5" Centers

Size	OEM	Edge	Order No	List
20"	93938	13 Wave	H93938	44.05
20"	93934	55 Wave/Ripple	H93934	45.10

## COULTER - 8 WAVE - SUMMERS

23" DIAMETER  
6.5MM THICK  
2" HOLE SIZE  
8.66" FLAT CENTER

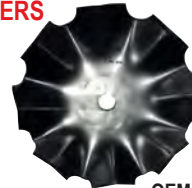

Application	OEM	Order No.	List
Summers Super Coulters & Super Coulters Plus. SC1510, SC1030, SC1530, SC1535, SC1550, SC1556	8J1021N	B45-1021F	94.86

## DEEP TILLAGE DISC RIPPER BLADES

Fits CIH, DMI Ecolo, Turbo Tiger, Turbo Tiger II, 527, 527B, 530, 530B, 730, 730B, 9300, ST650, ST720, ST770

Description	Diameter	Guage	Center Hole	Bolt Hole	Bolt Circle	Order Number	List
20" Curved Smooth Coulters Blade	20"	.25"	4"	(5) 1/2"	5.5"	B45-2530	50.56
22" Curved Smooth Coulters Blade	22"	.25"	4"	(5) 1/2"	5.5"	B45-2730	59.24



B45-2530



Disc Harrow Bearing Identification Code

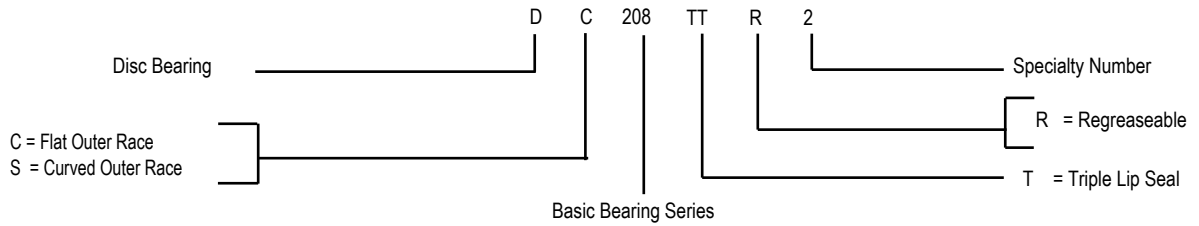

FLAT OUTER RACE - DC SERIES

BCA Number	Bore Size (A)	Outer Diam. (B)	Outer Race Width (C)	Inner Race Width (D)	Order No	List
DC208TT5	1-1/8", SQ	3.1496"	.709	1.438	B15-3180	15.57
DC208TT8	1-1/8", SQ	3.1496"	1.185	1.438	B15-3190	25.58
DC208TTR17	1-1/8" RD	3.376"	1.438	1.188	B15-3157	19.06
DC211TT3	1-1/2", SQ	3.397"	1.313	1.313	B15-3184	26.81
DC211TTR3	1-1/2", SQ	3.397"	1.313	1.313	B15-3188	27.25
DC211TT5	1-1/2", SQ	4.000"	1.438	1.750	B15-3182	30.48
DC211TTR14	1-3/4" RD	3.937"	1.313	0.984	B15-3160	22.63

CURVED OUTER RACE - DS SERIES

BCA Number	Bore Size (A)	Outer Diam. (B)	Outer Race Width (C)	Inner Race Width (D)	Order No	List
DS208TT6	1", SQ	3.158"	.709	1.438	B15-3176	25.13
DS208TT5	1-1/8", SQ	3.1496"	.709	1.438	B15-3050	21.02
DS208TT8	1-1/8", SQ	3.1496"	1.188	1.438	B15-3110	27.55
DS208TTR8	1-1/8", SQ	3.150"	1.188	1.438	B15-3186	25.98
DS208TT12	1-1/8", SQ	3.4340"	1.188	1.438	B15-3170	27.34
DS210TTR4	1-1/8", SQ	3.5433	1.188	1.188	B15-3144	31.50
DS208TTR5	1-1/8" SQ	3.150"	1.438	0.945	B15-3156	14.41
DS208TT7	1-3/16", RD	3.1496"	.709	1.188	B15-3080	16.92
DS209TT5	1-1/4", SQ	3.347"	1.188	1.438	B15-3185	19.69
DS209TT4	1-1/2", RD	3.3465"	1.188	1.188	B15-3120	21.21
DS211TTR3	1-1/2", SQ	3.397"	1.313	1.313	B15-3187	25.00
DS211TT3	1-1/2", SQ	3.9370"	1.313	1.313	B15-3150	26.81
DS211TT6	1-1/2", SQ	4.125"	1.438	1.750	B15-3181	30.48
DS209TTR10	1-3/4", RD	3.3465"	.866	1.438	B15-3130	32.92
DS209TT2	1-3/4", RD	3.347"	1.188	1.188	B15-3178	20.20
DS208TTR2	1-3/4" RD	3.347"	1.188	1.188	B15-3166	24.04
DS210TTR2	1-15/16", RD	3.5433"	1.188	1.188	B15-3142	22.45
DS211TTR2	2-3/16", RD	3.937"	1.313	1.313	B15-3177	23.47



All Herschel heavy duty disc bearings feature long lasting triple lip seals.

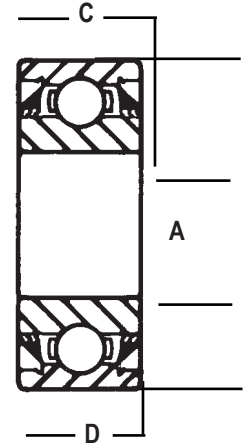

RIVETED 4-BOLT FLANGE -- FD SERIES

BCA Number	Bore Size (A)	Order No	List
FD209RA, ST491A	1-3/4", RD	B15-3010	28.13
FD209RB	1-1/2", RD	B15-3179	34.30

# TILLAGE - DISC BEARINGS DC SERIES

Order Number	OEM Number	B.C.A. Part No.	Fafnir Number	Bore Size / Type	Mfr.	Application
B15-3155	L-512-B	DS208TT11	W208PPB11	7/8" SQ.	Blanton	Disc Harrow
	BB2			Sealed	King	Disc Harrow
	990093				Long	Disc Harrow
	206090				Taylorway	Disc Harrow
	T603				Tuffline	Disc Harrow
B15-3176	11079	DS208TT6	W208PPB6	1" SQ Sealed	Amco Athens	LFB2, LFB2, LTB2
	14-22-63				Bush Hog	
	T15820				Case	Small Ridger
	710152				Hesston	Disc Harrow
	834367M1, 1025130M1				M. F.	21 Disc Harrow
	6519831				Melroe	
	552207				Tye	
B15-3161	20H4027	DS208TT9	W208PPB9	1" SQ. Sealed	Oliver White	Disc Harrow Disc Harrow
B15-3180	7129	DC208TT5	W208PP5	1-1/8 SQ Sealed	Athens	Ridger
	GA15				Bingham	Bedder
	7129				Blanton	Disc Harrow
	9554A				Burch	Ridger, 8 Row
	16-1-176, 795006				Bush Hog Charles Mach.	Bedder & Ridger Trencher
	H747139				Case	Trencher
	JD9350				Deere	F871, F901, F984, F981, F982 Bedder
	X08738, X09838				Deutz-Allis Forest City Hester	Ridger Disc Harrow
	963889R91				IH/Case	
	06A51-001 B8018				Kelly Kewanee	Coulter
					Minn-Moline	Hipper, Ridger
					Multi-Purpose	Ridger
					Piper Taylor	Disc Harrow, Ridger
	7992				Towner	100, 101 Ridger
	552209				Tye	
481202				W & A Mfg.	Ridger & Does More	
B15-3190	BC1	DC208TT8	W208PP8	1-1/8" SQ Sealed	Blanton	
	9C16				Brillion	
	AA14878				Deere	23, 2FK, F871, F901, F902, F984 Bedders
B15-3050	BC1				King Plow	
	10272	DS208TT5	W208PPB5	1-1/8" SQ Sealed	Amco Athens	WTD5,WTD6, LFD2, LFD82 Disc Ridger
	2J516				Brillion	
	J9373				Burch	Ridger, E-Z Set, E-2GO, Early 1-1/8 Axle Models
	T16288				Caldwell Case Chatanooga	
	JD9248, A20175				Deere	8500, F810H, F850H
	GK260				Dunham	Disc Harrow
	261750				Eversman	
	1R41009				Farmhand	
	630210R91				IH/Case	Ridger
	06A51001				Kelly	
	B7980, G0052604				Kewanee Krause	206, 400 Disc
	843638M1, 190566M1				M. F.	
	NDAS4508BJ 744-P				N.H. (Ford) Pico	LO, 175, 185, 200, 206, 300, LT400, 720
	24A5301 T60				Sunflower Tuffline	Disc Harrow, 1-1/8 Gang Bolt
B15-3110	10333	DS208TT8	W208PPB8	1-1/8" SQ Sealed	Amco	WTD10,WTD3,WTD4 Disc
	9C16				Brillion	
	T25486				Case	
	JD9286, JD9300				Deere	
	X10928				Deulz-Allis	
	213778B				New Idea	
	T151				Talbot	
	7906				Toner	101 Ridger
B15-3186	G10333	DS208TTR8	GW208PPB8	1-1/8" SQ Relube	Amco	13-1/2 Pulverizing Disc
	SBP238481B				Ford	241, 242, 243, 246, Disc Harrows
	B2151				Kewanee	500, 600 Disc
	SBP238481B				New Holland	
	238481B				Oliver	263 Disc
	207359				Taylor	200000, Series Disc

Order Number	W238481B OEM Number	B.C.A. Part No.	Fafnir Number	Bore Size / Type	White Mfr.	Application
B15-3170	1023	DS208TT12	W208PPB12	1-1/8" SQ	Blanton	Square Axle Disc
	14-24-26			Sealed	Bush Hog	Disc Harrow
	T28503				Case	Disc Harrow
	ST607, ST658				Case/IH Dunham	Disc Harrow (Wide O.R.)
	266740				Eversman Hardee IMCO	Disc Harrow Wheel Disc
	BB-2N				King Plow	KGB, WGH, EZB, MFB Disc Harrow
	37-61-001				Lilliston	
	9-90092				Long	958, 959 Disc
	447899M1				M. F. McClesky Rome Southern	34MTD & 33 Rev. Disc F228, L150 Harrow 7-1/2 Disc Harrow Disc Harrow, 13' Pulv. Disc
	204147				Taylor	Disc Harrow Light Duty 12-1/2, 19 & 21
	15013				Towner	101 Ridger 420, 425 Disc
	T602				Turflin	Disc Harrow 1-1/8
	B15-3156	G10272	DS208TTR5	GW208PPB5	1-1/8" SQ.	AMCO
A20175					John Deere	Disc Harrow
207359					Taylorway	Disc Harrow
B15-3157	142416BHIMP	DC208TTR17	GW208PP17	1-1/8" SQ.	Bush Hog	Disc Harrow
	1436183BHIMP			Relube	Bush Hog	Disc Harrow
B15-3144	B2246	DS210TTR4	GW210PPB4	1-1/8" SQ	Kewanee	100, 1025, 1100, 1200 Disc
B15-3080	430796	DS208TT7	W208PPB7	1-3/16" RD	Deutz-Allis	
	40-102,			Sealed		
	P-212-10-2				Krause	Disc Harrow
	9-90155				Long	
	237092B,				Oliver	241,352,250 Series Wheel Disc
	30-1005197, 1186				Sunflower	
237092B				White		
B15-3165	4050006, 4061005	DS208TTR10	GW209PPB8	1-1/4" SQ. Relube	Lilliston	Disc Harrow
B15-3125	5449031	DS209TTR5	GW209PPB5	1-1/4" SQ	Caukins	
	842342M1			Relube	M. F. Taylor	Disc Harrow
B15-3185	JD8664	DS209TT5	W209PPB5	1-1/4" SQ	Deere	9000 Drill, 4400 Combine
	126-068		FMC	Sealed	FMC	Harvester
	842303M1				M. F. Piper	520, 620 Disc Harrow Do-All
B15-3184	11071	DC211TT3	W211PP3	1-1/2" SQ	Amco	516, 517, F15 Disc Harrow
	H747444			Sealed	Athens	Levee Plow, 1st Series
	MULCBB112				Case	Trencher
	B2055				Deutz-Allis	K7 Disc
	1905678M1				Domries	1-1/2" Axle Series
	6510628				Ford	219, 223 Cutting Disc
B15-3188	G11071	DC211TTR3	GW211PP3	1-1/2" SQ	Amco	WOF3, WOF5, WOF6, WOJ3, WOJ4, Offset Disc
	14-6-430				Relube Athens	Disc Harrow
	T51653				Bush Hog	145, 146, 246, 1435, 1437 w/1-1/2" gang bolt
	G1046430				Case	E30, G109, G110, G119, K23, K23A Disc Harrow
	481213				Greenline Kewanee	Disc Harrow
B15-3150	3J131	DS211TT3	W211PPB3	1-1/2" SQ	W & A Mfg.	
	203214			Sealed	Brillion	
	7377-1				Burch	Offset Disc
	MULCB112SG				Farmhand	
	630095R91,				Ford	236 Cutting Disc
	ST627A, 6395R					
	832540M1				H/Case	New Ground Disc
4404-P				M. F. Pico	38, 41, 42 Disc Harrow HD Levee Plow, WO Series	
B15-3187	G10906	DS211TTR3	GW211PPB3	1-1/2" SQ	Amco	Disc Harrow
	78672A			Relube	Athens	Disc Harrow, New Ground Disc
	T51610				Burch	Offset Disc, Super Tandem
	70583939				Case	K23, K23A, G59 Disc
	9-92088				Deutz-Allis	2600 Disc
	449432M1				Long	
	207022				M. F.	30,40,520,620,720 Disc Harrow
	237909B				Taylor	Disc Harrow, Heavy Duty
					White	

# TILLAGE - DISC BEARINGS DS SERIES

Order Number	OEM Number	B.C.A. Part No.	Fafnir Number	Bore Size / Type	Mfr.	Application
B15-3181		DS211TT6	W211PPB6	1-1/2" SQ	Athens	Levee Plow, 2nd Series
	204-82			Sealed	Burch	Super Tandem 1973-Up
	9-90241				Chatanooga	Levi, Levi-Dyke Plow
	204679				Long	958, 959, 960, 1090 Disc Harrow
	18300				Taylor	Disc Harrow, Extra HD
					Towner	510, 515, 577, 532, 534, 535, 560, 600, 620, 621, 630
B15-3163		DS208TT2A	W208PPB2	1-1/2" RD. Sealed	MF	Disc Harrow
B15-3179	1A64318	FD209RB	DHU1-1/2 R209	1-1/2" RD	Farmhand	Disc Harrow
	700613			Relube	Hesston	Disc Harrow
	FC0481				Kent	Disc Harrow
	40-109				Krause	Disc Harrow
	1065010011				Landoll	Disc Harrow
	91134				Unverferth	Disc Harrow
	W238813				White	Disc Harrow
B15-3182	85481014	DC211TT5	W211PP5	1-1/2" SQ	Badger	
	406677			Sealed	Deutz-Allis	3100, K, KT, WKT Disc
B15-3120	340103	DS209TT4	W209PPB4	1.535" RD	Farmhand	Disc Harrow
	40-104			Sealed		
	P412-10-2				Krause	Disc Harrow
	34002				M. F.	
					Wil Rich	
B15-3124	AN240220	DS209TTR4	GW209PPB4	1.535 RD	Deere	
	21842400			Relube	DMI	
	EP6576				Farmhand	
	05A51001				Kelly	
	40-105, 612-10-2				Krause	Disc Harrow
	1065010003				Landoll	
	1829				Sunflower	
B15-3130	A20649	DS209TTR10	GW209PPB11	1-3/4" RD	Deere	210, 220, 230 Disc
				Relube		
B15-3010	ST491A	FD209RA	DHU491A	1-3/4" RD	IH/Case	315, 330, 350, 370, 470, 475, 480, 485, 490, 496, 610
				Relube		
B15-3160		DC211TTR14	GW211PPB13	1-3/4" Rd.	Sunflower	Disc Harrow
				Relube	Miller	Disc Harrow
B15-3162		DS210TT5	GW210PPB5	1-3/4" RD. Relube	Krause	Disc Harrow
B15-3166	7200460	DS208TTR2	GW209PPB2	1-3/4" RD.	Ford	Disc Harrow
	B7778			Relube	Kewanee	Disc Harrow
					Miller	Disc Harrow
B15-3178	14-4-5	DS209TT2	W209PPB2	1.7717" RD	Bush Hog	1432, 1436 Disc
	H747410			Sealed	Case	Trencher
	430478				Deutz-Allis	Disc Harrow
	310072				Farmhand	Disc Harrow
	113903				Ford	204, 210, 224, 230 Disc
	1251062C91				IH/Case	Disc Harrow
	835050M1				M. F.	28, 33, 34, 68 Disc Harrow
	20H2152				Minn-Moline	Disc Harrow
					Shaffer	Disc Harrow
	7044				Unverferth	Disc Harrow
B15-3142	G10771	DS210TTR2	GW210PPB2	1-15/16" RD	Amco	Disc Harrow
	T53781			Relube	Case	F21, F21H Disc Harrow
	G10771				Farmhand	Disc Harrow
B15-3159	14-50-5	DC210TTR9	GW210PP9	1-15/16" SQ.	Bush Hog	Disc Harrow
				Relube		
B15-3183	11052	DS210TT2	W210PPB2	1-15/16" RD	Amco	Disc Harrow
					Burch	EZ, EZ-A, EZ-B, 145 Disc, 30565
					Sealed	Kwik Set Hipper/Ridger
	14-5-109				Bush Hog	145
	K85				Domries	
	10771				Farmhand	
	177849				Ford	
					G & M	3 PT Vinyard Disc
831960M3				M. F.	Plow	
3055,3056				Shaffer	Disc Harrow	
					Strathmore	
408808D				White		
B15-3135		DC210TT2	W210PP2	1-15/16"RD	Amco	
				Sealed	White	
					Domeries	
B15-3177	T57559	DS211TTR2	GW211PPB2	2-3/16" RD	Case	
	24022			Relube	Wil Rich	Disc Harrow
B15-3189	GW211PP2S				Sunflower	
	DC211TT2S					
B15-3158		DC211TTR2	GW211PP2	2-3/16" RD.	Athens	Disc Harrow
	146244BHIMP			Relube	Bush Hog	Disc Harrow
					John Deere	Disc Harrow
					Kewanee	Disc Harrow
B15-3164	B2289				Allis Chalmers	Disc Harrow
	430480	DS211TT2	W211PPB2	2-3/16" RD.	Case	Disc Harrow
	H747170			Sealed	IH	Disc Harrow
	958334R91				Wilbeck	Disc Harrow

CASE-INTERNATIONAL DISC REPLACEMENT PARTS



OEM Number	Description	Application	Order No.	List
468584R2	Bumper Washer	Fits 46, 48, 150, 330, 350, 370, 470, 475, 480, 485, 490, 496	H468584R2	23.88
481611R1	End Washer	Fits Models 132, 150, 330, 350, 370, 470, 475, 480, 485, 490, 610	H481611R1	7.92
PA4167	End Washer	Fits Models 132, 150, 330, 350, 370, 470, 475, 480, 485, 490, 610	HPA4167	8.62
472592R3	Spool	1-5/8" SQ HOLE 7-1/2". Fits Old Style 37, 46, 48, 60, 61, 120, 122, 130, 132, 150, 350, 370, 470, 480	H472592R3	10.86
472593R3	Spool	3" SQ HOLE 9" SPACING. Fits Old Style 37, 46, 48, 60, 61, 76, 120, 122, 130, 132, 150, 330, 350, 370, 470, 480, 610, 760	H472593R3	13.23
472591R3	Spool	4" SQ HOLE 7-1/2" & 9". Fits Old Style 37, 46, 48, 60, 61, 76, 120, 122, 130, 132, 150, 330, 350, 370, 470, 480, 610	H472591R3	15.69
101189C1	Spool	1-5/8" RD HOLE 7-1/2". Fits New Style 350, 370, 470, 475, 485, 490, 496, 3800 & 3900	H101189C1	10.93
101190C1	Spool	3" RD HOLE 9" SPACING. Fits New Style 132, 350, 475, 485, 490, 496, 3800 & 3900	H101190C1	12.84
101191C1	Spool	4" RD HOLE 7-1/2" & 9". Fits New Style 132, 350, 370, 470, 475, 485, 490, 496, 3600 & 3900	H101191C1	13.01
481416R1	Spool	7-1/2" SQ HOLE. Fits Models 46, 48, 60, 61, 120, 122, 130, 132, 150, 330, 350, 370, 470, 475, 480, 485, 490 & 496	H481416R1	28.69
481417R1	Spool	9" SQ HOLE. Fits Models 37, 46, 48, 60, 61, 120, 122, 130, 132, 150, 330, 350, 370, 470, 475, 480, 485, 490 & 496	H481417R1	31.04
652383R1	5-1/16" Sleeve	Fits Models 470 & 480 (11 ga. tubing)	H652383R1	4.26
652412R1	7-1/4" Sleeve	Fits Model 490 (11 ga. tubing)	H652412R1	4.82
112410C1	8-3/4" Sleeve	Fits Model 470, 475, 480, 485, 490 & 495 (11 ga. tubing)	H112410C1	5.13
129532C2	Holder	Fits Models 490, 496, 3800 & 3900	H129532C2	52.50
121119C92	Scraper RH	Fits Models 475, 90, 496, 3900	H121119C92	24.22
121120C92	Scraper LH	Fits Models 475, 90, 496, 3900	H121120C92	24.05



OEM Number	Description	Application	Order No.	List
A20621/N241315	Spool 1-7/8	Fits Models With 7-1/4" & 9" Spacing. New Style	HA241315	15.77
A20622/N241318	Spool 3-7/8	Fits Models With 7-14" Spacing	HN241318	18.89
A37024/N241320	End Washer		HN241320	11.79
AN183629	Double Spool	Fits Models With 9" Spacing. Heavy Duty	HAN183629	37.58
A20006	Blade Scraper	Fits Models 110, 111, 115, 210, 220, 230	HA20006	10.85
N242189	Scraper Spring	For HAP38364	HN242189	5.23
AN240886	Scraper Arm RH	Fits 630, 640, 215, 235, 627, 635, 637	HAN240886	44.49
AN240887	Scraper Arm LH	Fits 630, 640, 215, 235, 627, 635, 637	HAN240887	44.49
AA30941	Disc Gang Bearing Kit	Fits Models 210, 215, 220, 230, 235, 621, 630, 635 & 637	HAA30941	41.19
AA28184	Disc Gang Bearing Only.	Fits Models 210, 215, 220, 230, 235, 621, 630, 635 & 637	HAA28184	27.74
A34792	Flange W/O Zerk	Fits Models 210, 215, 220, 230, 235, 621, 630, 635 & 637	HA34792	6.07
AA27172	Flange W/ Zerk	Fits Models 210, 215, 220, 230, 235, 621, 630, 635 & 637	HAA27172	6.77
AA30942	Disc Gang Bearing Kit	Fits Models 310, 315, 330, 331, 335, 340, 350, 355, 360, 370, 637, 640, 650, 670, 512 Ripper.	HA30942	63.75

SUNFLOWER DISC REPLACEMENT PARTS - MODEL 1232 DISC W/1-1/2" ROUND AXLE

OEM Number	Description	Order No.	List
2816	Bearing Spool	H2816	24.48



## BEARINGS



Water pump type, short shank w/ groove. JD, MF & Noble. Also fits Great Plains, Lilliston/Melroe, Tye, & United Farm Tool Grain Drills. Replaces AN131668, 446612M1, 369851 and 885154B.

Order Number	List
B15-0901	7.02

Water pump type, short shank w/hole. JD 7000, 7100, 7200, 7300 Planters for both gauge wheel & closing wheel. Also fits row marker disc assembly. Replaces AA21015, AA35741, GA2022 and 885152. White 5100, 5700 Series Gauge Wheels.

Order Number	List
B15-0902	9.36



Water pump type, double end - smooth. Noble and early model Glencoe Cultivator. Also fits Crust-buster, Tye, Great Plains, & United Farm Tool Grain Drills. Replaces 601440F1, P6310 and 885118B.

Order Number	List
B15-0903	8.49



Water pump type, long shank w/ groove. IH, Case and Glencoe cultivators. Replaces 526769R91, T26882, P3573 and 885151E.

Order Number	List
B15-0907	10.57

## BUSHING

Sleeve, used as spacer on Bearing B15-0902. JD planter gauge wheels. Replaces A25915 and GB118.

Order Number	List
S44-0003	2.78

## CLOSING WHEEL ASSEMBLY

Nylon. Agco-White Planters. 1"x12". JD 7000, 7100, MaxEmerge™, Kinze prior to 1993 with bearing. Replaces AA33297, GA3086, 017630 and AA43899



Order Number	List
W29-0160	48.91

## GAUGE WHEEL HALVES

All Wheel Halves will accommodate any of the above mentioned bearings.



Replaces Number	Application	Order Number	List
A22780	Painted Yellow for JD Planter Gauge Wheels. Fits W29-0158 Assy. 4.5x15. JD MaxEmerge™, 750, 1560, 1850 drills.	W29-0163	13.34

## CLOSING WHEELS

JD 1700 planter, 1530 & 1535 drills, Kinzie planter 93 & Newer with bearing. 1"x12". Replaces AA39968 and GA6434



Order Number	List
W26-0166	51.02

## GAUGE WHEEL ASSEMBLIES

Replaces Number	Application	Order Number	List
AA32046	Painted Yellow for JD 7000,7100,7200 & 7300 Series Planters.	W29-0158	115.77
AA35392	4.5" x 15". With hole in bearing stem.		
GA2021	Painted White, Kinzie and Agco-White Planters. 4.5" x 15".	W29-0161	77.34

## TIRES



Replaces Number	Application	Order Number	List
A22884	Tire only for Gauge Wheel for JD 7000,7100,7200,7300 Series Planters, also fits Kinzie, Agco-White, fits W29-0158 & 247812B	W29-0162	37.95
GD1086			
AA22325	Tire only for closing wheel on JD, Kinzie and Agco-White Planters.	W29-0159	8.25
GD1085	Fits W29-0160 Assembly. 1" x 12".		
017632			

## 8" COVERING DISC FOR CASE-IH & NEW HOLLAND

Fits Case-IH Planters, all 900, 950, 955 and 1200 series; 5400, 5500 Soybean Special; New Holland SP280, SP380 & SP580. Includes blade, bearing retainer, rivets and dust cap. Replaces 1277891C91.



Order No.	List
H1277891C91	25.83



**BEARING**  
7/8" hex bore. Has curved O.D. used on seed and fertilizer drives. Replaces JD no. AA22097.

Order No: HAA22097 **13.16**



**BEARING**  
7/8" hex bore. Has flat O.D. Replaces JD no. AA28271.

Order No: HAA28271 **8.77**



**BEARING**  
For clutch actuator shaft. 9/16" hex bore. Fits 7000 flex fold, 7200 & 1750. Replaces JD no. AA34259.

Order No: HAA34259 **13.25**



**BEARING**  
Closing wheel bearing for John Deere Model 7200, 7300 and IHC mode 296 & 386 planter, Bore Size: 0.669" round, O.D: 1.574" flat, IR width: 0.55", OR width : 0.472".

Order No: HAA35638 **9.12**



**BEARING**  
Bearing with cross hole to fit gauge wheel assemblies. Has a 40 mm O.D. to eliminate the use of the bearing spacer.

Order No: HAA35951B **13.29**



**BEARING**  
Double row ball bearing with 5/8" ID for closing & gauge wheel. Double Row Angular Contact Planter Bearing.

Order No: HAN212132 **9.53**



**BEARING**  
Ball bearing, ID: 15mm (.59"), OD: 42mm (1.65"), Width: 22mm (.87")

Order No: HCJ13975 **6.88**



**BEARING**  
204 series seed opener bearing, 5/8" hole. Fits multiple planter openers including JD, White, and Kinze. Bearing for Crustbuster openers. Replaces No's 400580 & 401042. 2 used per opener on Crustbuster All Plant series.

Order No: HAA21480 **5.96**

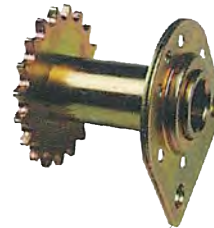

**BEARING/SPROCKET**  
Bearing with 19 tooth sprocket, 7/8" hex bore, 2-1/8" width. Used on 7200-7300 and 1700 series planters row unit and planter drive line. Replaces JD no. AA36212.

Order No: HAA36212 **25.36**



**BEARING/SPROCKET**  
Bearing with 19 tooth sprocket, 7/8" hex bore, 1-1/2" width. Used on John Deere 7200, 7300 and 1700 series planters row unit and planter drive line.

Order No: HAH133868 **34.39**



**BEARING/SPROCKET**  
Planter Drive Sprocket - 9/16" hex. Fits 700, 7100, Max Emerge, 7100 Soybean Special.

Order No: HAA30654 **25.43**



**BEARING/SPROCKET**  
Sprocket and bearing with standard for row unit. 19 tooth fits 7300 JD 7200 and 1700 series planters. Replaces JD no. AA35645. Hub width is 3.25"

Order No: HAA35645 **25.43**



**BOLT**  
Pivot bolt for walking gauge wheel. Fits John Deere MaxEmerge@Plus, Pro, XP Pro, 1530 and 1535 planters. Also late John Deere MaxEmerge@2 planters.

Order No: HA58670 **2.74**



**BUSHING**  
Wheel arm pivot bushing. Fits John Deere planters 7000, 7100, 7200, 1750, 1770.

Order No: HA64190 **7.58**



**BUSHING**  
For closing wheel arm. Replaces H2204B.

Order No: HA2204 **3.25**



**BUSHING**  
For closing wheel arm. 2 Required. Fits MaxEmerge Plus, Pro, XP Pro, 1530 and 1535. Replaces A55888.

Order No: HA55888 **7.00**



**BUSHING**  
Fits John Deere 1700, 1760, 1780, 7200, 7300, MaxEmerge 2, 120XP, Plus, Pro. Replaces A48515.

Order No: HA48515 **1.87**



**BUSHING**  
For Parallel arms on John Deere 7000 - 7100; Kinze 2000 Series. Replaces A23789 and GB0218

Order No: HA23789 **1.60**



**BUSHING**  
Self-aligning bushing. Fits 1700, 1710, 1720 Series Planters and attachments. Replaces AA57058.

Order No: HAA57058 **6.15**



**BUSHING**  
Cam bushing, left hand. For closing wheel arm. Fits 7300 Series MaxEmerge 2 Planters. Replaces A48290.

Order No: HA48290 **3.71**



**BUSHING**  
Cam bushing, right hand. For closing wheel arm. Fits 7300 Series MaxEmerge 2 Planters. Replaces A48430.

Order No: HA48430 **5.96**



**CLOSING WHEEL ARM**  
Cast closing wheel arm for John Deere Max Emerge Plus, PRO, XP PRO, 1530, 1535 series.

Order No: HA86763 **55.43**



**CLOSING WHEEL ARM**  
Closing wheel arm for John Deere 7000, 7100. Replaces JD no. AA31217. Can be used to replace Kinze GA6056.

Order No: HAA31217 **40.34**



**CLOSING WHEEL ARM**  
Closing wheel arm for John Deere 1760, 1780, 7200, 7300, 7340 planters. Replace JD numbers AA37552 & AA37839. Comes with spindles for wheels.

Order No: HAA37552 **47.01**



**CLOSING WHEEL ARM STOP**  
Cast iron closing wheel arm stop, painted green. Fits 7000, 7100; Kinze (except 3000 series). Replaces JD No A28135, A33879; Kinze No GB0113.

Order No: HA33879 **16.14**



**DUST CAP**  
Dust cap only for double disc fertilizer openers. Made of metal, Zinc covered.

Order No: HA22836 **1.44**



**DUST CAP**  
Dust Cap for seed bearing housing. 1-1/2" diameter. Used on AA55927, AA37474

Order No: HA52024 **1.05**



**DUST CAP**  
Dust cap for seed disc opener, smaller cap diameter 1-1/4".

Order No: HAG78218 **1.09**



**GAUGE WHEEL ASSEMBLY**  
Nylon/steel wheel halves & 5203KYY2 bearing.

Order No: HA66604 **108.58**



**GAUGE WHEEL ARM KIT**  
Has threaded bushing for proper adjustment of the gauge wheel to the seed disc opener. Updates older planters to the new style arm design. Comes with two different threaded bushing, one for older series of planters and one for the newer series. Fits models JD 7100, 7200, 7300 & Max Emerge 1760, 1780, 1700, 1710, 1721 series Planters. Replaces AA41968, AA54179.

Order No: H25502B **34.03**



**GAUGE WHEEL ARM KIT**  
Fits 7000 thru early 1700, 1710, 1720 plus. Kit includes threaded bushing, arm and hardware. Replaces AA41968. Wheel mounts with set screw.

Order No: HAA41968 **57.90**

**Bushing (Self-Aligning) ONLY**  
H41968B **7.03**



**GAUGE WHEEL ARM KIT**  
Fits 1720 XP Series. Includes threaded bushing and mounting hardware. Replaces AA79648. Wheel mounts with hex bolt.

Order No: HA79648 **39.42**



**GAUGE WHEEL HALF**  
Nylon gauge wheel half. Fits John Deere planters and drills with nylon/steel wheel half combination gauge wheels. XP and XP Pro planters; 1560, 1590, 1690, 1835, 1860, 1890, 1895 and 1990 grain drills. Fits Case-IH New Holland planters with nylon/steel wheel half combination gauge wheels.

Order No: HA56565 **30.00**



**HANDLE**  
Plastic drive release handle for plateless hopper drive. Replaces JD A25447, Kinze GD1035.

Order No: HA25447 **3.39**





**HANDLE**

Handle for closing wheel arm on John Deere Max Emerge® 2, Plus, Pro, and XP row units. Replaces JD number A64237.

Order No: HA64237 **8.00**



**HUB**

Fertilizer Hub for JD Double Disc Openers Fertilizer unit. Cast hub without bearing.

Order No: HAWFHUB **19.12**



**IDLER**

Plastic idler the diameter is 2-1/4", for drive wheels, will replace John Deere A22628.

Order No: HA22628 **2.28**



**IDLER**

Diameter is 1-9/16", for seed drive on vacuum and finger pickup units, also used on insecticide/herbicide drive. Fits JD MaxEmerge 2 prior to 1992, will replace JD A22838.

Order No: HA22838 **1.43**



**IDLER**

Plastic idler with 1-7/8" dia, used on liquid or dry fertilizer driver, seed transmission drive and insecticide or herbicide drive, will replace John Deere B30968

Order No: HB30968 **1.78**



**IDLER**

plastic idler used on liquid or dry fertilizer driver, seed transmission drive and insecticide or herbicide drive, will replace John Deere B30969.

Order No: HB30969 **2.98**



**IDLER ARM**

Poly. Replaces JD no. A52062. Fits 720, 7300 Max Emerge 2, 1760 and 1780.

Order No: HA52062 **2.82**



**OPENER GUARD**

Fits 7200 and newer planters. Replaces JD no. A48879. Fits 7200, 7330, Max Emerge 2, 1760, 1780, Max Emerge Plus, XP.

Order No: HA48879 **9.14**



**PIN**

For planter arm, work with A69141.

Order No: HAA55143 **1.88**



**PIVOT STOP KIT**

Fits MaxEmerge Plus, Pro, XP, XP Pro, 1530, 1535, also late MaxEmerge, including: A82772 John Deere XP planter stop, A62609 John Deere XP planter rocker, A58670 John Deere XP planter pivot bolt.

Order No: HA62609K **34.38**



**ROCKER**

For walking gauge wheel. 3/4" pivot hole and built-in pivot stops. Fits MaxEmerge®Plus, Pro, XP Pro, 1530, 1535. OEM No.:A62609

Order No: HA62609 **44.81**



**SCRAPER**

Inside fertilizer scraper for double disc openers. One used per row.

Order No: HAB35913 **3.21**



**SCRAPER ASSEMBLY - LEFT**

Fits John Deere 7000, 7100 MaxEmerge; 7200, 7300 and 1700 Planter with MaxEmerge 2 and MaxEmerge Plus Row Units; Kinze. Replaces AA26444 and GA2012L.

Order No: HAA26444L **6.49**



**SCRAPER ASSEMBLY - RIGHT**

Fits John Deere 7000, 7100 MaxEmerge; 7200, 7300 and 1700 Planter with MaxEmerge 2 and MaxEmerge Plus Row Units; Kinze. Replaces AA26443 and GA2012L.

Order No: HAA26443R **5.86**



**SCRAPER**

Heavy duty seed blade scraper for planter parts, model 7200, 7300, 1760, 1780. For use in sticky soils.

Order No: HA62182 **6.31**



**SCRAPER KIT**

Fits John Deere Planter 1705 thru 1795, DB44 thru DB120. Replaces OEM # A98183, A98182. Includes LH Scraper, RH Scraper and Tension Spring.

Order No: H98180K **14.23**



**SCRAPER KIT**

Tungsten carbide edge. Fits John Deere 1530, 1535, 1700, 1720, 1730, 1760, 1789, 1790, 7100, 7200, 7300, 7340. Kit includes 1 LH and 1 RH Scraper, 1 spring and 2 hairclips. Replaces AA62808.

Order No: HAA62808 **39.29**



**SCRAPER KIT**

Fits John Deere 1530, 1535, 1700, 1720, 1730, 1760, 1789, 1790, 7100, 7200, 7300, 7340. Kit includes 1 LH (nylon covered), 1 RH Scraper Arm, 1 Spring, 2 Cotter Pins. Replaces BA28945.

Order No: HAA37221K **17.70**  
Rotating Scraper Wheel Only  
HAA37221 **3.86**



**SCRAPER WHEEL**

Fits John Deere 7000, 7100, 7300, 7340, MaxEmerge 2, Pro, Plus, XP and XP Pro.; White Planters 5100, 5700, 6000 and 8000. Replaces AH133315.

Order No: HAH133315 **3.25**



**SEED GUARD**

Fits John Deere 1760, 1780 (before 2/97); 7000, 7100, 7200. Replaces A41692.

Order No: HA41692 **8.07**



**SEED GUARD**

Fits John Deere 1700 Series Planters and Attachments. For use with curved seed tube, bracket welded to seed guard. Replaces P61577.

Order No: HA61577 **9.49**



**SEED TUBE**

Fits John Deere 1700 series planters. Regular curve with large monitor hole. Replaces A74934.

Order No: HA56784 **7.02**



**SEED TUBE**

Fits John Deere 7200, 7330, 7340 series planter. Small monitor hole. Replaces A55880.

Order No: HA55880 **7.02**



**SEED TUBE CLIP**

For JD 1785 & 1985 XP. Will replace JD A55984, AP00178 clip.

Order No: HA55984 **1.26**



**SEED TUBE PROTECTOR**

For XP row units

Order No: HA80203 **7.78**



**SPACER**

Fits models John Deere 7200, 7300, 7240, 1760, 1780, 1700 XP series.

Order No: HA43610 **2.36**



**SPACER**

For closing wheel arm. 2 per arm. Replaces A52556. Fits 7200, 7300, Max Emerge 2, 1760, 1780 and Max Emerge Plus.

Order No: HA52556 **2.63**



**SPRING**

Idler arm spring. Replaces John Deere no.'s A28518, A63534 and Kinze GD1065. Used on 7000, 7200, and 1700 series.

Order No: HA28518 **2.07**



**SPRING**

Tension left hand spring for heavy duty scraper, for John Deere 1700 series planter units and attachments.

Order No: HA41116 **2.54**



**SPRING**

Tension right hand spring for heavy duty scraper, for John Deere 1700 series planter units and attachments.

Order No: HA41117 **2.54**



**SPRING**

Standard down pressure spring for John Deere planters. Bolts to side of parallel arms. Two or four used per row. Replaces JD no. A43609. Used on Max Emerge & Max Emerge Plus.

Order No: HA43609 **16.26**



**SPRING**

Idler arm spring for Herbicide/Insecticide drive. Replaces JD no. A49644. Used on 1700, 7200 and 7300 series.

Order No: HA49644 **2.14**



**SPRING**

Closing wheel spring for John Deere Model 1760, 1780 7200, 7300 MaxEmerge 2and 7340. Coiled part is 3 3/4", overall length is 7".

Order No: HA74643 **18.76**



**SPRING**

Heavy duty down pressure spring with plug. Replaces JD no.'s AA28046 and AA35876; Kinze no GA2068. Also used on Kinze contact drive wheels.

Order No: HAA35876 **19.06**



**SPRING**

Down pressure spring with plug. Fits John Deere 7000, 7100 series Planters; Kinze. Replaces AB10071 and GA2052.

Order No: HAB10071 **7.14**



**SPRING**

Closing Wheel spring with plug. Fits John Deere 7000, 7100 series Planters; Kinze. Replaces A23116 and GA2054.

Order No: HA23116 **11.73**



**SPRING**

Fits Rotating Scrapers and Tungsten Carbide Scrapers. Replaces A50047.

Order No: HA50047 **1.79**



**SPROCKET**

14 tooth idler sprocket for 40 chain. Fits seed transmission on John Deere planters 7200, 7300 and 1700 series; dry fertilizer transmission on 7200, 7240, 1750, 1770, 1780, 7000 Flex-Fold.

Order No: HAA32729 **17.36**



**SPROCKET**

Fits 1700 Series Planters and attachments. Finger pickup and vacuum meter drive. Plateless herbicide and insecticide drive. Replaces A55008.

Order No: HA55008 **1.34**



**SUPPORT**

Support, seed guard, replace A54868. Fits 7200, 7300 Max Emerge 2, 1760, 1780, Max Emerge Plus, 700, 7100, Pro Series.

Order No: HA54868 8.77



**TIRE**

4.5" x 16" tire with standard profile offset. Fits John Deere planters XP, XP Pro row units; 1530, 1535 with XP.

Order No: HA84062 49.72



**CLOSING WHEEL ASSEMBLY**

Nylon. Agco-White Planters. 1"x12". JD 7000, 7100, MaxEmerge™, Kinze prior to 1993 with bearing. Replaces AA33297, GA3086, 017630 and AA43899

Order No: W29-0160 48.91



**CLOSING WHEEL**

JD 1700 planter, 1530 & 1535 drills, Kinzie planter 93 & Newer with bearing. 1"x12". Replaces AA39968 and GA6434

Order No: W29-0166 51.02



**CLOSING WHEEL**

JD 1700 Series, 7200, 7240, 7300, 7340 MaxEmerge2 planters, 1520, 455, 750 drill. with bearing. 1"x12". .669 axle diam. Replaces AA43898 and AA34211.

Order No: W29-0167 42.10

**KINZE PLANTER PARTS**

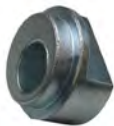

**BUSHING**

Eccentric bushing for GA8322 Arm, heat treated. Zinc plated.

Order No: HGB0239 2.82



**BUSHING**

Hex stepped bushing for G8322 arm, heat treated.

Order No: HGB0282 3.65



**CLOSING WHEEL ARM**

Closing wheel arm for Kinze built 1993 and later. For use with bolt on wheels. Replaces Kinze GA8322.

Order No: HGA8322 42.10



**GAUGE WHEEL ARM**

Planter gauge wheel arm for Kinze. Has thread hole at the bottom to attach the gauge wheel. Has threaded bushing at the top for adjusting the gauge wheel to the seed disc opener.

Order No: HGA6614 29.82



**GAUGE WHEEL ARM**

Gauge wheel arm. left hand. replaces Kinze GA7975, fits Kinze 3000 series.

Order No: HGA7975 43.85

**GAUGE WHEEL ARM**

Gauge wheel arm. Right hand. Replaces Kinze GA7976, fits Kinze 3000 series.

Order No: HGA7976 43.85



**LEVER**

Closing wheel adjusting lever; Kinze 1993 and newer.

Order No: HGB0254 6.14



**SPRING**

New style down pressure spring for quick adjust. Fits Kinze only.

Order No: HGD8429 6.13





**Revolutionary Seed Firmer Technology  
Distributed By Herschel Parts.**

- Memory Polymer
- Lower Replacement Cost
- Optimum Seed Placement
- Made By Farmers For Farmers
- Lifetime Guarantee On Flo-Rite Adjustable Brackets

# flo-rite

---

## seed firmers

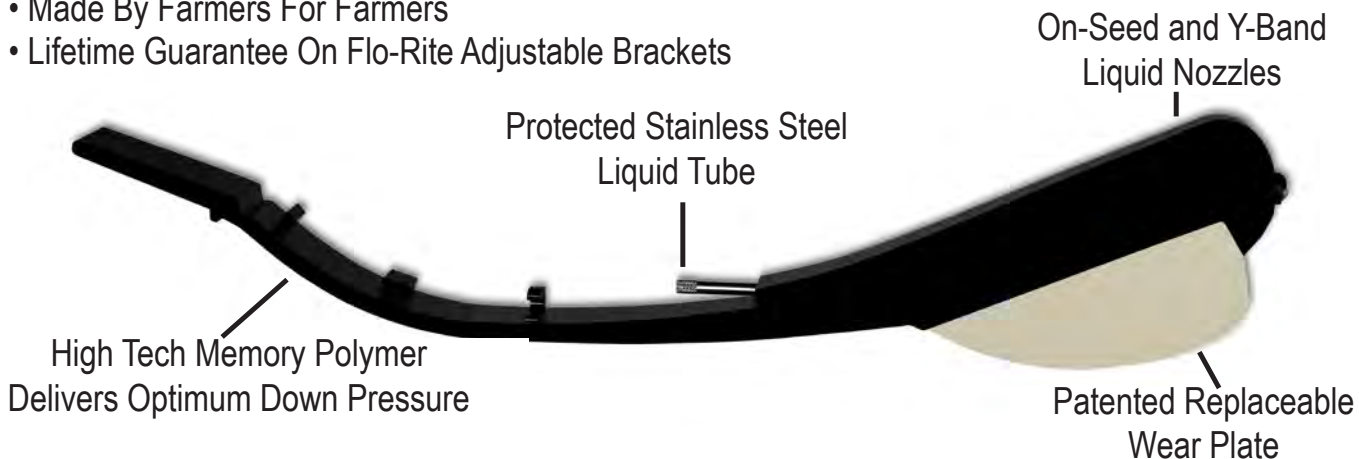

**WHY SHOULD YOU USE FLO-RITE SEED FIRMERS?**

**1. Lower Replacement Costs**

Although Flo-Rite seed firmers initially cost about the same as other leading seed firmer brands, maintenance costs of Flo-Rite seed firmers are dramatically less. Flo-Rite's exclusive replaceable wear plate saves farmers money over time. With traditional seed firmers, when the firmer contact point wears out, you have to replace the entire seed firmer unit. But with Flo-Rite seed firmers, you simply replace the wear plate and the firmer works just like new.

**2. Optimum Seed Placement**

Flo-Rite seed firmers use the latest in memory polymers to provide reliable down pressure to assure the best seed placement and proper seeding depth. Flo-Rite's optimal down pressure maximizes the proper seed to soil contact needed to improve germination success.

**3. Protected Liquid Tube**

Another problem with traditional seed firmers is that the liquid tubes are "bracketed" on the outside of the seed firmer body. This leaves the liquid tube exposed to crop debris and soil that can rip the tube from the firmer body. But with Flo-Rite's patent pending enclosed stainless steel liquid tube, this problem is eliminated so you can keep on planting!



**SEED FIRMER**

Universal. For attachment to planter seed tube. With hardware.

PN: FR100 **List 35.95**



**SEED FIRMER**

Fits all Precision Planting® Universal Mounting Bracket and Flo-Rite brackets FR550, FR575 and FR650.

PN: FR200 **List 35.95**



**SEED FIRMER**

Low Profile without replaceable wear plate. Fits all Precision Planting® Universal Mounting Bracket and Flo-Rite brackets FR550, FR575 and FR650.

PN: FR210 **List 35.95**



**SEED FIRMER**

Fits all Precision Planting® quick attach brackets.

PN: FR230 **List 35.95**



**SEED FIRMER**

Low Profile. Fits JD Exact-Emerge with FR555 bracket. CNH 800-1200 series. Mounts to seed boot.

PN: FR425 **List 35.95**



**SEED FIRMER**

With replaceable wear plate. Fits most drills w/existing Precision drill brackets. Fits Flo-Rite brackets FR570, FR565 and FR655.

PN: DF420W **List 35.95**



**REPLACEABLE WEAR PLATE**

Fits all firmers w/replaceable wear pad.

PN: FR350 **List 7.95**



**FOAM APPLICATOR TIP**

Fits all Flo-Rite Seed Firmers and allows application of foam using the 3RIVE® and other similar systems. Sold 8 per bag.

PN: FR300 **List 14.30**



**INSERT & REMOVAL TOOL**

Used to remove and install wear plates the easy way.

PN: FR400 **List 89.95**



**JOHN DEERE 7000 ADJUSTABLE MOUNTING BRACKET**

Fits John Deere 7000 planters. Mounts in planter frame using factory holes. Use DF420W firmer.

PN: FR570 **List 41.25**



**JD MAXEMERGE 5 ADJUSTABLE BRACKET**

Mounts on planter frame. Use with FR200 and FR210. Vertical adjustment.

PN: FR550 **List 41.25**



**JD EXACTEMERGE ADJUSTABLE BRACKET**

Bolts using factory holes in closing wheel frame. Use with FR425.

PN: FR555 **List 41.25**



**JD XP ROW UNIT ADJUSTABLE BRACKET**

Complete with hardware. Use with FR200 or FR210. Mounts in planter frame factory holes.

PN: FR575 **List 41.25**



**JOHN DEERE DB ADJUSTABLE MOUNTING BRACKET**

Fits John Deere DB planters. Mounts in planter frame using factory holes. Use with DF420W firmer.

PN: FR565 **List 41.25**



**KINZE 4900 ADJUSTABLE BRACKET**

Mounts in planter frame. Use with FR200 and FR210. Vertical adjustment.

PN: FR650 **List 41.25**



**KINZE 3000 ADJUSTABLE BRACKET**

Complete with hardware. Use with DF420W. Mounts in planter frame factory holes.

PN: FR655 **List 41.25**

**PLANTER TALC AND GRAPHITE**

**TALC POWDER**

- Maximizes yield and profit by increasing plant population per acre.
- Reduces moisture generated by vacuum planters.
- Helps prevent "bridging" of seeds in planter by reducing moisture.
- Helps seed flow smoothly and evenly through vacuum meter planters.
- Reduces wear on vacuum meter components.

Size	Order No.	List
8 lb Jug	A 735300	22.41
20 lb Box	A 735301	34.44
20 lb Bucket	A 735302	55.47



**GRAPHITE POWDER**

- Maximizes yield and profit by increasing plant population per acre.
- Easiest, most convenient way to apply seed-flow lubricant. No buildup.
- Helps prevent "bridging" of seeds in the planter.
- Helps seed flow smoothly and evenly through high-speed planters.
- Reduces wear on planter plates.

Size	Order No.	List
1 lb Bottle	A 735304	6.94
5 lb Jug	A 735303	21.17
20 lb Box	A 735305	68.86



**80/20 TALC GRAPHITE**

- Designed exclusively for treated seed.
- Increases planting efficiency and maximizes yield per acre.
- Use in both "gravity flow" and "air" planters.
- Reduces moisture issues, lubricates seed and equipment.
- Helps prevent "seed bridging" in the planter.
- High-purity for less meter wear.
- Non-toxic
- Apply 4-6 oz each time hopper is filled with seed.

Size	Order No.	List
8 lb Jug	A 735307	34.10
20 lb Box	A 735308	41.07

Low Drift 80/20	Order No.	List
12 lb Jug	A 735310	32.78



**EZ-MEASURE FLIP LID**

New lid allows application with minimal human or wind exposure and gives precise amount measurements. Measures in 1/8 cup increments. Fits 8 lb jugs.



Order No: A 735312    17.27



## ROW CROP CULTIVATOR SWEEPS

- Punched with three holes - two on 2" centers for 7/16" x 1-3/4" bolts and the center hole is square for a 5/8" x 1-3/4" carriage bolt.
- 54 degree shank angle.

- The wings have been flattened and the crown lowered which allow for higher speeds and less dirt being pushed on the crops.
- Used on the Allis Chalmers, the Forrester City Du-All, Buffalo No-Till cultivator, Case, Cockshutt 237, 239, 337, and Minntoba LDC.
- 3/16" thickness.
- Uses 7/16 x 1-3/4" #3 Plow Bolt.

Made In The USA

Size	Description	Order No.	List
4"	Plain, Full	22404	10.23
6"	Plain Full	22406	10.35
8"	Plain	22408	11.61
8"	Hardfaced Bottom Side, Full	24408H	28.71
10"	Plain	22410	14.42
10"	Hardfaced Bottom Side, Full	22410H	55.59
12"	Plain, Full	22412	17.72
14"	Full	22414	26.77
16"	Full	22416	31.67
18"	Plain, Full	22418	39.86
20"	Plain, Full	22420	48.12
22"	Plain, Full	22422	56.85
24"	Plain, Full	22424	62.36
26"	Plain, Full	22426	65.96

Made In The USA



- 1/4" Thick
- Constant Width Wings
- Heat Treated Boron Steel

## FIELD CULTIVATOR SWEEPS

**924 Series** will fit Bourgault, Crustbuster, DMI, Harris, Hesston, Hinker, IHC Vibra Shank, Ingham, John Deere 960 Series, Kent, Kewanee, Landoll, Massey Ferguson, Sunflower and Wilrich. **Requires 7/16" no. 3 head bolts. 1-3/4" hole spacing. 1/4" thick. 47° Stem angle.**

**934 Series** will fit Anderson, Bush Hog, CCIL 179, 379 and Z, Case FC, FCM and FCSW, Cockshutt 285 and 485, Ford 208, Glencoe 101, Kewanee, Krause 600 and 900, Leon Vibra Flex Massey Ferguson 160, Minneapolis Moline FT 200, Morris L240 and L320, Oliver 285, 385 and 485, Taylor, and White. **Requires 3/8" x 1-1/4" no. 3 head bolts. 1-3/4" hole spacing. 1/4" thick. 47° Stem angle.**

**944 Series** will fit Allis (early models), Baker, Brady (prior to 70-71), Brillion (prior to 1986), Cockshutt (early models), Deere (CCA, CC10, CC20, and 1000 Series, Glencoe (1250 double shank), Krause (k-tine), and Oliver (245 and 345). **Requires 3/8" x 1-1/4" no. 3 head bolts. 1-5/8" to 1-3/4" hole spacing. 1/4" thick. 41° Stem angle.**

### 924 SERIES - 47° STEM ANGLE

Size	Description	Order No	List
4"	Plain	92404	9.03
6"	Plain	92406	9.19
7"	Plain	92407	9.40
7"	Hardfaced Top Side	92407H	30.25
8"	Plain	92408	11.34
9"	Plain	92409	11.52
9"	Hardfaced Top Side	92409H	31.29
10"	Plain	92410	13.47
10"	Hardfaced Top Side	92410H	30.40
11"	Plain	92411	14.07
11"	Hardfaced Top Side	92411H	34.77
12"	Plain	92412	15.44

### 934 SERIES - 47° STEM ANGLE

Size	Description	Order No	List
4"	Plain, Slotted Hole	93404S	13.37
6"	Plain	93406	11.25
7"	Plain	93407	11.96
8"	Plain	93408	13.45
9"	Plain	93409	13.87
10"	Plain	93410	15.64

### 944 SERIES - 41° STEM ANGLE

Size	Description	Order No	List
4"	Plain	94404	10.94
6"	Plain	94406	11.25
7"	Plain	94407	11.96
9"	Plain	94409	13.83

## FIELD CULTIVATOR SWEEPS

- Popular Long Wearing design
- Dimple to protect premature bolt wear
- Extended Nose for longer wear and better penetration
- Constant Width Wings-will cut same width from new until worn out
- Quality Boron Steel heat treated for long life
- Knock on sweeps fit Nichols style clips only
- Available in both 1/4" & 5/16" thick

ORDER NO	DESCRIPTION	THICKNESS	CRATE QTY	LIST
<b>KNOCK-ON</b>				
S85-0707	7" N SERIES KNOCK ON SWEEP	1/4"	800	8.64
S85-0807	7" N SERIES KNOCK ON SWEEP	5/16"	800	8.90
S85-0709	9" N SERIES KNOCK ON SWEEP	1/4"	750	9.14
S85-0809	9" N SERIES KNOCK ON SWEEP	5/16"	750	9.99
S85-0810	10" N SERIES KNOCK ON SWEEP	5/16"	500	11.73
S85-0811	11" N SERIES KNOCK ON SWEEP	5/16"	500	12.42
<b>BOLT-ON</b>				
S85-1707	7" N SERIES BOLT ON SWEEP	1/4"	800	7.50
S85-1807	7" N SERIES BOLT ON SWEEP	5/16"	800	7.99
S85-1709	9" N SERIES BOLT ON SWEEP	1/4"	750	8.50
S85-1809	9" N SERIES BOLT ON SWEEP	5/16"	750	9.99
S85-1810	10" N SERIES BOLT ON SWEEP	5/16"	500	10.65
S85-1811	11" N SERIES BOLT ON SWEEP	5/16"	500	11.14
<b>HARDWARE</b>				
C45-0608	Clip 2" Spacing 47 deg			4.20
C45-0607	Clip 1-3/4" Spacing 47 deg			4.20
C45-0610	Retainer Spring. Ensures sweep does not fall off clip. Not required.			2.26



## FURROWERS HIGH BACK 400 SERIES

Heat treated boron steel for long life. 1/4" Thick. 7/16" Bolt Size for plow bolts. 1-1/4" to 2-1/4" hole spacing.

Width Bottom	Order No	List
12"	412	30.08
12"	412H	56.52
15	415	42.26
15	415H	78.83
18	418H	91.93



## TERMINATOR II SWEEPS

1/4" thickness. 47 degree stem. 7/16" bolt size. 1-3/4" hole spacing. Contoured wings provide better soil disturbance across entire sweep for improved weed control. Extended sweep point improves soil penetration. Hammer-lock sweeps use clips listed below.



Made In The USA

- Sweep point is 5/8" longer than Terminator I Sweeps for improved soil penetration.
- Contoured wings are 7/16" wider than Terminator I Sweeps which results in better soil action.
- Clipped style wings maintain full cutting width and prolonged sweep life.
- Hammer-Lock design eliminates unbolting and rebolting.
- Accurately fits Empire and McKay mounting clips.

Size	Description	Order No.	List
7"	Bolt-On	S85-0515	11.88
7"	Hammer-Lock	S85-0537	11.88
9"	Bolt-On	S85-0516	12.59
9"	Hammer-Lock	S85-0539	12.59
10"	Bolt-On	S85-0517	13.07
10"	Hammer-Lock	S85-0540	13.07



## FURROWERS - 600 SERIES

All 600 Series Furrowers are punched with 3 holes. Two holes for 7/16" plow bolts on 2-1/4" centers and one square hole, centered for 5/8" carriage bolt. Made from 1080 High Carbon Steel. Heat Treated for Longer Wear.

Material Thickness	Bolt Size	Hole Spacing
1/4"	2) 7/16" Plow Bolts or 1) 5/8" Carriage Bolt	2-1/4"

Size	Width		Description	Order No	List
	Bottom	Top			
6"	6"	9.25"	Plain	608	22.87
6"	6"	9.25"	Hardfaced	608H	31.79
8"	8"	9.5"	Plain	610A	22.87
8"	8"	9.5"	Hardfaced	610H	39.72
10"	10"	14"	Plain	612	26.74
10"	10"	14"	Hardfaced	612H	41.45
12"	12"	15"	Plain	615	30.79
12"	12"	15"	Hardfaced	615H	50.82
15"	15"	20"	Plain	618	40.31
15"	15"	20"	Hardfaced	618H	68.36

## HAMMER-LOCK SWEEP

Constant Width. 49 degree stem angle. 1/4" Thickness. Use clips listed below.

Made In The USA

Size	Description	Order No.	List
4"	Plain	S85-0404	11.30
7"	Plain	S85-0405	12.43
9"	Plain	S85-0406	13.75
10"	Plain	S85-0407	16.33



## HAMMER-LOCK SWEEP

Constant Width. 41 degree stem angle. 1/4" Thickness. Use clips listed above right.

Made In The USA

Size	Description	Order No.	List
4"	Plain	S85-0410	15.43
7"	Plain	S85-0411	15.55
9"	Plain	S85-0412	17.51



## FURROWERS - LISTER SHARES

All Lister Style Furrowers are punched with 1 square hole, centered for 3/4" carriage bolt. Made from 1080 High Carbon Steel. Heat Treated for Longer Wear.

Material Thickness	Bolt Size	Hole Spacing
1/4"	3/4"	Centered

Size	Description	Order No	List
14"	Plain	1014	35.06

## MOUNTING CLIP FOR HAMMER-LOCK SWEEPS

Made In The USA

Install clip only once when using hammer-lock designed sweeps.

Replaces No.	Bolt Size	Hole Spacing	Order No.	List
LKM-7	7/16"	1-3/4" - 2" Slotted	C45-0408	4.09
		Safety Spring	C45-0510	2.48



C45-0510

## HEEL SWEEP

Thickness: 1/4"  
Width: 18"  
Shank: 50 degrees  
Holes: 2 holes 1/2" slotted  
Hole Spacing: 2-1/4" to 2-1/2"



**Application:** Fits over top of a chisel plow shank and is used in conjunction with a chisel point being bolted on over the top of this heel sweep. Our CB75 or HA13S would be popular choices for this.

**Benefits:** Provides cultivating and chiseling in the same pass. It can also be used in manure application in some areas.

Order No	List
HEEL18	21.16

## SLIM SHANK SPOONS & SWEEPS

S85-0523

S85-0521

Designed to leave field smoother. For use on Air Seeders and Field Cultivators. Full width clipped wings.



Size	Description	Order No	List
2"	Seeder Spoon	S85-0522	10.41
3"	Seeder Spoon	S85-0523	11.37
9"	Sweep, Plain, 47° Shank	S85-0519	22.29
11"	Sweep, Plain, 47° Shank	S85-0521*	23.04
	Clip, Slim Shank, Flat Back, Fits Bourgault, E-Z On, and works with McKay Sweeps. Uses 1/2" Hex Bolts for installation.	C45-0409	9.26
	Clip, Slim Shank, Curved Back, Fits CCIL 200, Degelman, Flexi-Coil, JD 960 & 985, Leon, MF 160 & 259, Morris, Wilrich, and works with McKay Sweeps. Uses 1/2" Plow Bolts for installation	C45-0410	9.54





**JOYCE SWEEPS**

Used Primarily in California and Arizona for Cultivation of Cotton and Potatoes. Higher Crown and Wing Lift for Greater Soil Disturbance than the 224 Series Sweeps. 55 degree stem angle. Punched with three holes

- two on 2-1/4" centers for 7/16" x 1-3/4" bolts and the center hole is square for a 5/8" x 1-3/4" carriage bolt.

**Made In The USA**

Size	Full, Right, or Left	Order No.	List
6"	Plain, Full	44406	10.90
6"	Hardfaced, Full	44406H	14.15
8"	Plain, Full	44408	12.05
10"	Plain, Full	44410	13.49
12"	Plain, Full	44412	15.23
14"	Plain, Full	44414	19.00
14"	Hardfaced, Full	44414H	32.74
16"	Plain, Full	44416	23.05
18"	Plain, Full	44418	28.03
24"	Hardfaced, Full	44424H	82.38

**ALABAMA SWEEPS**

All Alabama Sweeps are punched with 3 holes. Two holes for 7/16" plow bolts on 2-1/4" centers and one square hole, centered for 5/8" carriage bolt.



Material Thickness	Stem Angle	Bolt Size	Hole Spacing
1/4"	55°	7/16" & 5/8"	2-1/4"

Size	Description	Order No.	List
12"	Plain	51H12	12.30
14"	Plain	51H14	9.23
16"	Plain	51H16	11.76
16"	Hardfaced	51H16H	42.73
18"	Plain	51H18	16.28
18"	Hardfaced	51H18H	49.30
20"	Plain	51H20	26.54
22"	Plain	51H22	18.24
24"	Plain	51H24	43.17



**CULTIVATOR SHANK CLIP FOR IHC**

Replaces no. 511985-R21. Fits 252 Cub, Cub 3 cultivators no. C-244, 254, 452, 652, 647, 2C254A and K-254. Also fits all C, Super C and Super A cultivators.

Description	Order No.	List
Shank Clip	A 484964	23.55

**PEANUT BLADES**

Fits KMC (03-081-068), Lilliston, Amadas and Others. Sold in pairs (1 Left, 1 Right). Requires 3/8" #3 Plow Bolts.

**ADAMS DESIGN ADAMS QUALITY**

- Made From Boron Steel
- Heat-Treated To Increase Wear
- Oil Quenched
- Painted Green



Length	Thickness	# Of Bolts	Order No	List
42"	3/8"	3	PNB	75.80

**WING SWEEPS - V-PLOW BLADES**

5/16" Thick. 1/2" X 1-1/2" #3 Bolt. 75 degree angle. Eagle Beak, Chrome Alloy Point. Rod Hard-Faced. Clipped Wing. **Made In The USA!**



Fits Noble, Krause, Flex King, TriFlex, ARK Valley, Sunflower, Richardson, Bush Hog, John Deere, Hayhawk, Vasser, Davies and Miller.

Size	Description	Order No	List
5'	Hard-Faced Bottom Side, Inserted	05HBSCP	367.06
5'	Hard-Faced Top Side, Inserted	05HTSCP	367.06
5-1/2'	Hard-Faced Bottom Side, Inserted	055HBSCP	390.59
5-1/2'	Hard-Faced Top Side, Inserted	055HTSCP	390.59
6'	Hard-Faced Bottom Side, Inserted	06HBSCP	406.27
6'	Hard-Faced Top Side, Inserted	06HTSCP	406.27
6-1/2'	Hard-Faced Top Side, Inserted	061/2HTSCP	410.98
7'	Hard-Faced Top Side, Inserted	07HTSCP	476.86

# TILLAGE

## DANISH SWEEPS

1/4" thickness. Designed to fit Danish S-Tine and other field preparation equipment of this type. Require 3/8" x 1-1/2" elliptical head bolt (H10 type). Dimple to protect bolt head. Heat-treated. **Made In Iowa.**



Description	Style	Order No	List
1-1/2" point	A	S32-0001*	1.96
2-3/4" duckfoot	B	S32-0016	3.65
4" duckfoot	C	S32-0017	4.44
4" v-design	D	S32-0018	4.44
7" sweep	E	S32-0019	5.81
9" sweep	E	1409A	7.11

\*Imported

## 2-HOLE DANISH STYLE SWEEPS

- 5/16" Thick
- 2 Bolt Holes- 1.5" hole spacing
- Uses 7/16" Elliptical Head Bolts
- High Quality Boron Steel
- Fits Kongskilde, Unverferth and others



Description	Order No.	List
2-3/4" Duckfoot	S32-0020	4.90
4" Duckfoot	S32-0041	5.00
4" Danish	S32-0040	5.00
7" Danish	S32-0070	5.65

## DANISH SWEEPS - HARDFACED

1/4" Thick. 3/8" x 1-3/8" bolt hole. Requires H10 bolt type. Heat-treated. Made of 10B22 Boron steel with a black finish. Excellent for high speed cultivation.



Size	Description	Style	Order No	List
1-1/2" x 7-1/4"	Reversible Point	A	1401H	6.05

## DANISH TINES / S-TINES

S-Tines and clamps are made to demanding OEM specifications. Tines are constructed of high quality steel with rounded edges - shot peened and painted black. For all S-Tine Danish Cultivators.



Replaces Number	GC	Size	Description	Order No	List
P5215	14.5"	3/8" x 22" x 1-1/4"	Standard	T16-0001	13.02
P5315	14.25"	1/2" x 22" x 1-1/4"	Heavy Duty	T16-0003	14.54
P5415	18"	1/2" x 26" x 1-3/4"	HD, Long	T16-0004	23.95

## CLAMPS FOR DANISH TINES/S-TINES

Use 1/2" Carriage Bolts.



Size	Fits S-Tine No.	Replaces	Order No.	List
2" x 2". 1-3/8" Slot.	T16-0001, 0003	J24	C41-0004	5.78
2-1/2" x 2-1/2". 1-3/8" Slot	T16-0003, 0001	T260	C41-0011	7.63
2" x 2". 1-7/8" Slot	T16-0004	J28	C41-0028	13.31
2.5" x 2.5". 1-7/8" Slot	T16-0004		C41-0030	7.02

## WHEATLAND (CHISEL PLOW) SWEEPS 22 SERIES

1/4" thickness with a 50° stem angle. Uses a 7/16" bolt. 2-1/4" hole spacing. Medium crown. Constant width.

Designed to fit Anderson, Case-High Clearance, Cockshutt, CCIL, Degelman, Frigstad, Glencoe, Graham - 600 Series, John Deere - 650, 1100, 1600, Krause, Landoll, Massey, Mel-Cam, White and Others With 22" Shanks.

Size	Description	Order No	List
12"	Plain	1222C	18.55
14"	Plain	1422C	22.33
16"	Plain	1622C	23.54
18"	Plain	1822C*	28.19
18"	Hard-faced, Bottom Side	1822CH	52.60



## WHEATLAND (CHISEL PLOW) SWEEPS 22G SERIES

1/4" thickness with a 47° stem angle. Uses a 7/16" hole spacing. Medium crown. Constant width.

Designed to fit Anderson, Case, Glencoe, Ge Massey-Harris.

Size	Description	Order No	List
14"	Plain	1422GC	22.33
16"	Plain	1622GC	23.31



## WHEATLAND (CHISEL PLOW) SWEEPS 225G SERIES

1/4" thickness with a 47° stem angle. Uses a 1/2" bolt. 2-1/4" hole spacing. Medium crown. Constant width.

Designed to fit Anderson, Case, Glencoe, Geisler and Massey-Harris.

Size	Description	Order No	List
14"	Plain	14225GC	22.55
16"	Plain	16225GC	23.54
18"	Plain	18225GC	27.91



## WHEATLAND (CHISEL PLOW) SWEEPS IH SERIES

1/4" thickness with a 43° stem angle. Uses a 1/2" bolt. 2-1/4" to 2-1/2" hole spacing. Medium crown.

Designed to fit IHC models 10, 50, 55; CCIL 203 & 204, Morris and Wilrich

Size	Description	Order No	List
10"	Plain	IH10C	17.27
12"	Plain	IH12C	18.55
14"	Plain	IH14C	22.55
16"	Plain	IH16C	23.05
16"	Hard-Faced, Bottom Side	IH16CH	48.61
18"	Plain	IH18C	28.17
18"	Hard-Faced, Bottom Side	IH18CH	50.59



## CHISEL SWEEPS - CS SERIES

5/16" thickness with a 50° stem angle. 2-1/4" hole spacing.

Use in place of chisels for more soil movement.

Size	Description	Bolt Size	Order No.	List
6"	Plain	7/16"	CS06	5.77
7"	Plain	1/2"	CS505	12.69
7"	Hard-Faced, Top Side	1/2"	CS505H	15.54



## WHEATLAND (CHISEL PLOW) SWEEPS 225 SERIES

1/4" thickness. 50 degree stem. 1/2" bolt size. 2-1/4" hole spacing. Medium crown. Constant width. Designed to fit Figstad, Graham, Hiniker, John Deere, Leon and Mohawk



Size	Description	Order No	List
10"	Plain	10225C	17.12
10"	Hard-Faced. Bottom Side	10225CH	32.17
12"	Plain	12225C	18.55
14"	Plain	14225C	22.55
16"	Plain	16225C	23.05
16"	Hard-Faced. Bottom Side	16225CH	45.08
18"	Plain	18225C	28.19
18"	Hard-Faced	18225CH	53.13

## WHEATLAND (CHISEL PLOW) SWEEPS 516 SERIES

5/16" thickness. 50 degree stem. 1/2" bolt size. 2-1/4" hole spacing. Low crown. Standard wing. Designed to fit QuinStar Fallow Master and Sunflower Fallow King, Kent and John Deere. Reinforced wings



Size	Description	Insert	Order No.	List
26"	Plain		26516	62.49
26"	Hard-Faced. Bottom Side		26516H	68.38
26"	Hard-Faced. Top Side		26516HTS	68.38
26"	Hard-Faced. Top Side	79CC	26516H79	71.57

## WING SWEEPS

5/16" thick with 3/8" bolt hole. Designed for Hiniker and Kinzie. Will also fit other Ridge Till Cultivators with 8" hole spacing including Buffalo, Krause and Sukup. Reversible with double bevel.

Width	Description	Order No.	List
15"	Plain	A5115	12.41
19"	Plain	A5119	15.06
23"	Plain	A5123	16.57
27"	Plain	A5127	19.18
27"	Hard-Faced	A5127H	19.18



## WHEATLAND (CHISEL PLOW) SWEEPS 505 SERIES

1/4" thickness. 50 degree stem. 1/2" bolt size. 2-1/4" hole spacing. Low crown. Constant width. Designed to fit Figstad, Graham, Hiniker, John Deere, Leon and Mohawk



Size	Description	Order No.	List
16"	Plain	16505C	22.82
18"	Plain	18505C	28.19
18"	Hard-Faced. Bottom Side	18505CH	45.12

Standard wing.

Size	Description	Order No.	List
20"	Plain	20505	35.75
22"	Plain	22505	51.51
26"	Plain	26505	78.22

## SPRING TOOTH SWEEPS - STS SERIES

1/4" thickness with a 31° stem angle. 3/8" bolt size. 2" hole spacing. Made from 1080 high tensile steel. Fits Bush Hog, Crustbuster and Calkins. Replaces points on spring tooth harrow and some cultivators.



Size	Description	Order No.	List
6"	Plain	STS06	6.60

## SPRING TOOTH POINTS - ST SERIES 11" LENGTH

Plated and sharpened for better wear. Oil quenched and heat treated. Fits field cultivators, spring tooth harrows and row crop cultivators.



Width	Thickness	Bolt Size	Hole Spacing	Description	Order No.	List
2"	1/4"	3/8"	1-1/4" to 2-1/4"	Plain	ST11	9.85
2"	1/4"	7/16"	1-1/4" to 2-1/4"	Plain	ST12	9.85
2-1/2"	1/4"	3/8"	1-1/4" to 2-1/4"	Plain	ST13	6.37
1-3/4"	1/4"	3/8"	2"	Plain	ST14	9.91
2"	3/8"	3/8"	1-1/4" to 2"	Plain, Heavy Swedged Nose	ST20	8.33
2"	3/8"	7/16"		Plain, Heavy Swedged Nose	ST21	8.33

## SPRING TOOTH POINTS - CC SERIES

5/16" Thick. 11" length. 1-3/4" wide. Fits spring tooth harrows, field cultivators and row crop cultivators.



Bolt Size	Spacing	Hole Description	Order No.	List
3/8"	1-3/8" to 1-3/4"	Plain	CC01	9.70
3/8"	1-3/8" to 1-3/4"	Inserted	CC01I	25.36
7/16"	1-3/4"	Plain	CC03	9.70
7/16"	1-3/4"	Inserted	CC03I	24.07
3/8"	2"	Plain. Fits Crustbuster Drills	CC06	10.36
3/8"	2"	Inserted. Fits Crustbuster Drills	CC06I	25.36

## ALFALFA SPIKES

No Twist. 2-1/4" hole spacing. Reversible.

Size	Bolt	Order No.	List
3/4" x 2" x 15"	1/2"	17522	17.42
3/4" x 2" x 15"	1/2"	17522H*	43.10

\*Hardfaced.



## CHISEL POINT WITH INSERT

Chrome carbide insert. 2-1/4" x 2-1/2" Hole spacing. Uses #3-1/2" plow bolt.

Size	Bolt	Order No.	List
3/4" x 2" x 13-1/2"	1/2"	HA13S	46.51



## CHISEL POINT - CB SERIES

3/4" Thick. 13" Long. 2" Wide. Will wear up to 10 times longer than plain points. Insert design directs soil flow away from bolt heads. Chromium carbide tips #61 Adalloy. Uses #3-1/2" plow bolt.

Bolt	Hole Spacing	Order No.	List
1/2"	2-1/4" to 2-1/2"	CB75	24.54

CB75



# TILLAGE

## CHISEL POINTS

Reversible spikes have upset (swedge) points for increased wear and longer life. Even after considerable use, these spikes retain their original shape and stay sharp.

Made In The USA



Size - T x W x L	Bolt Spacing	Bolt Size	Order No.	List
1/4" x 1-3/4" x 9-1/16"	Single Hole	3/8"	P57-0063	7.53
1/4" x 1-3/4" x 11"	1" to 2"	3/8"	P57-0963	9.91
1/4" x 1-3/4" x 11"	1-3/4"	3/8"	P57-0965	13.46
1/4" x 1-3/4" x 11"	1-3/4"	3/8"	P57-0966	9.76
1/4" x 1-3/4" x 11"	1-3/4"	7/16"	P57-0973	9.86
5/16" x 2" x 9-1/2"	1-3/4"	7/16"	P57-0072	8.65
5/16" x 2" x 10-1/2"	1-1/4" to 2-1/4"	7/16"	P57-0202	8.57
3/8" x 2" x 11"	1-1/4" to 2"	3/8"	ST20	8.33
3/8" x 2" x 11"	1-1/4" to 2"	7/16"	ST21	8.33
5/8" x 2" x 17"	2-1/4"	7/16"	45022	16.46
5/8" x 2" x 17"	2-1/4"	7/16"	45022H	44.51
5/8" x 2" x 17"	2-1/4"	1/2"	45522	16.46
5/8" x 2" x 17"	2-1/4"	1/2"	45522H	44.96
5/8" x 2" x 17"	2-1/4"	3/4"	47522	18.33
5/8" x 2" x 17"	2-1/4"	3/4"	47522H	46.27
5/8" x 2" x 15"	2-1/4" to 2-1/2"	1/2"	P57-0230	15.79
1" x 2" x 18"	2-1/4" to 2-1/2"	1/2"	P57-0260	25.03
1" x 2-1/2" x 18"	2-1/2"	1/2"	P57-0265	29.17

## 3-PIECE SOIL SAVER

Uses 1/2" Clipped head bolt. ADI stands for Austempered Ductile Iron. Used with SOS05 & SOS06.



Fits Brillion, Bush Hog, Duetz-Allis, Glencoe, Kelly, Kent, Krause, Landoll, MF, Sunflower, Etc.

Description	Order No.	List
Hard-Faced, Right. 4-1/8" w x 3/8" Thick	SOS03H	19.33
Plain, Left. 4-1/8" w x 3/8" Thick	SOS04	9.64
Hard-Faced, Left. 4-1/8" w x 3/8" Thick	SOS04H	19.33
Left ADI Point. Hex bolt	P57-0105	58.18
Right ADI Point. Hex bolt	P57-0106	58.18
Clipped Head Bolts	B55-0530	15.16

## SHANK SAVERS - POLY

SOLD IN BOX QUANTITIES

Size/ Application	Hole Spacing	Bolt Size	Box Qty.	Order No	List
1-3/4" x 9" x 1/4"	1-5/8" to 2"	3/8"-7/16"	100	P44-0360	290.35

## CRESCENT HOES

1/4" Thick. 3/8" Bolt size. 1-1/4" to 1-3/4" hole spacing.



Size	Description	Order No	List
6"	Plain, Left	CH06L	15.41
6"	Plain, Right	CH06R	15.41

## TENDER PLANT HOES

3/16" Thick. 3/8" Bolt size. 1-1/4" to 1-3/4" hole spacing.



Size	Description	Order No	List
7"	Plain, Left	TP07L	5.11
7"	Plain, Right	TP07R	6.48
9"	Plain, Right	TP09R	6.71

## CHISEL POINTS

### 200 SERIES

Reversible, No twist. 1-Piece. 2" Wide. 15" Long. 2-1/4" hole spacing. Made of high carbon steel. Heat-treated.

Thickness	Bolt Size	Description	Order No	List
5/8"	7/16"	Plain	25022	20.80
5/8"	7/16"	Hardfaced	25022H	48.43
5/8"	1/2"	Plain	25522*	18.21
5/8"	1/2"	Hardfaced	25522H	38.72
3/4"	1/2"	Plain	27522	17.44



## CHISEL POINTS - REVERSIBLE, TWISTED. 1-PIECE

1/2" Thick. 3" Wide. 22" Long. Fits all high clearance chisel plows. 1/2" Holes.



Width	Description	Bolt Size	Hole Spacing	Order No	List
3"	Plain, Left	1/2"	2-1/4" to 2-1/2"	TC125L	20.70
3"	Plain, Left	1/2"	2-1/4" to 2-1/2"	TC125LH	51.59
3"	Plain, Right	1/2"	2-1/4" to 2-1/2"	TC125R	20.70
3"	Plain, Right	1/2"	2-1/4" to 2-1/2"	TC125RH	51.59
4"	Plain, Left	1/2"	2-1/4" to 2-1/2"	P57-0271*	25.55
4"	Plain, Right	1/2"	2-1/4" to 2-1/2"	P57-0270*	25.55

\*21" Long. 4" Wide

## CHISEL POINT REVERSIBLE - 1 PIECE

2" Wide. 1/2" Bolt size. 2-1/4" to 2-1/2" hole spacing.



Thickness	Length	Hole Replaces	Description	Order No	List
1"	18"	HD88	Plain	P57-0260	25.03

## SLASH POINTS - TWISTED CHISEL - 1 PIECE

One piece chisel will replace the complete three piece moldboard assemblies on chisel plows. 2-1/4" Hole spacing. .4" bolt size.



Fits Brillion, Bush Hog, Duetz-Allis, Glencoe, Kelly, Kent, Krause, Landoll, MF, Sunflower, Etc.

Description	Size	Order No.	List
Plain, Right	1/2" x 4" x 24"	SOS01	26.84
Hard-Faced, Right	1/2" x 4" x 24"	SOS01H	60.22
Plain, Left	1/2" x 4" x 24"	SOS02	26.84
Hard-Faced, Left	1/2" x 4" x 24"	SOS02H	60.22

## CHISEL SHOVELS

Reversible spikes have upset (swedge) points for increased wear and longer life. Even after considerable use, these spikes retain their original shape and stay sharp.



Size - T x W x L	Bolt Spacing	Bolt Size	Order No.	List
1/4" x 4" x 15-1/2"	2-1/4" to 2-1/2"	1/2"	505	17.80
1/2" x 4" x 15-1/2"	2-1/4" to 2-1/2"	1/2"	P57-0370	26.62
5/16" x 4" x 14-1/4"	2-1/4" to 2-1/2"	1/2"	P57-0350	22.78

SUBSOILER/RIPPER POINTS



BIGOX



SS11



608C

Size	Description	Cap	Bolt Size	Hole Spacing	Application	Order No.	List
1-1/4" x 1-7/8" x 7-1/4"	Plain		Drive-on	N/A	Caterpillar, Scarifier, Big Ox	BIGOX	27.91
1-1/4" x 1-7/8" x 7-1/4"	Capped	26CC	Drive-on	N/A	Caterpillar, Scarifier, Big Ox	BIGOXH	45.27
1" x 2" x 12"	Plain		1/2"	3"	Case, JD A17994, 90V, 900V, Q30681, Kelly	SS02	19.83
1" x 2" x 12"	Capped	12CC	1/2"	3"	Case, JD A17994, 90V, 900V, Q30681, Kelly	SS02H	33.86
3/4" x 2-1/4" x 12"	Plain		Booted	N/A	Case, JD A17994, 90V, 900V, Q30681, Kelly	SS04	23.44
3/4" x 2-1/4" x 12"	Capped	08CC	Booted	N/A	JD AA31215, 510, 415, 55, 900, 910,913, 915 955, 2700, 2720, 2730, 2100 - 1/1/4" shanks	SS04H	38.32
1" x 2-1/2" x 12"	Capped	95CC	Booted	N/A	Winged	SS04HW	94.49
1" x 2-1/2" x 12"	Plain, HD		Booted	N/A		SS04HD	26.95
3/4" x 2" x 10-1/4"	Plain		Booted	N/A	Brillion IJ481	SS07	26.58
3/4" x 2" x 10-1/4"	Capped	12CC	Booted	N/A	Brillion IJ481	SS07H	42.19
1/2" x 1-3/4" x 6"	Plain		Booted	N/A	Hamby H30, Johnson, Howard	SS08	24.00
1/2" x 1-3/4" x 6"	Capped	26CC	Booted	N/A	Hamby H30, Johnson, Howard	SS08H	42.38
1" x 2" x 8-1/2"	Plain		Booted	1/2"x2" Roll Pin	Forrest City	SS10	22.73
1" x 2" x 11"	Plain		Booted	3/8"x2" Roll Pin	New Kelly, KMC, 1" Shank	SS11	22.24
1" x 2" x 11"	Capped	12CC	Booted	3/8"x2" Roll Pin	New Kelly, KMC, 1" Shank	SS11H	35.16
3/4" x 2-1/2" x 12"	Plain		Form.Ear	1/2"x2-1/2"	M&W 60 & 65 Earthmaster Series	HA2438357	13.69
1-1/2" x 10"	Chrome Cap		Booted	N/A	DMI, Turbo Tiger®, Tiger Two®, Turbo Tiger II® Ecolo Tiger®	HA09907000	132.31
6"	Covering Point For HA09907000				527, 527B, 530B, 530C, 730B, 730C, 6750, 9300, ST650, ST720, ST775	608C	17.73
8"	Covering Point For HA09907000				530, 530B, 530C, 730, 730B, 730C, 9300, ST770, ST775	610C	19.26

SOIL RIPPER™

The new SoilRipper tillage points feature a robust design and superior fine grain chromium-carbide steel to withstand the most challenging soil conditions, providing the best overall value choice. Brought to you by the company you can trust for leading quality.

John Deere 510, 512, 55, 900, 910, 913, 915, 955, 2700, 2720, 2730, 2100 all with 1-1/4" wide shanks

DMI/CNH 500, 527, 527B, 690, 870, 875, 900, 1000, 1300, MRX690, ST720, ST740, 2500. ALSO FITS FRONT SHANK ONLY ON: 530, 530B, 530C, 730, 730B, 730C, 9300, ST770, ST775

KUHN/KRAUSE Dominator, Landbuilder, TL3000 Disc Ripper

FEATURES

- Patent pending
- More robust design with extra high strength steel for longer service life
- Wing and nose surface geometry generates maximum soil fracturing while reducing draft loads
- As they wear, SoilRipper points maintain their ability to penetrate the toughest soil conditions
- Wear feature protects mounting hardware
- Ideal for high speed compaction-busting tillage applications

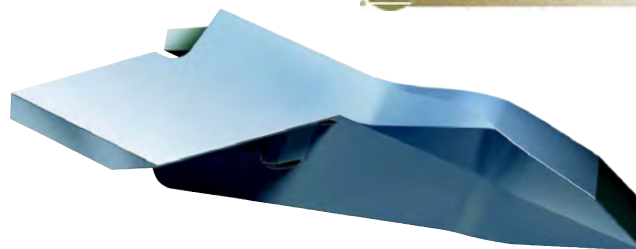

SPECIFICATIONS

- Solid one-piece cast for extreme durability with super hard steel
- Formed from fine grain chromium-carbide steel
- Rockwell hardness score of 48-50 Rc
- 7.5" winged SoilRipper point designed for a 1.25" shank width
- 24 lbs.
- Designed to fit Case-IH, DMI, Krause and John Deere equipment
- Additional designs, models and sizes to come

Order No.	List
SS37C	129.33

SUBSOILER CAPS - CHROMIUM CARBIDE



Size	Application	Order No	List
2" x 4"	Fits 1-3/4" Wide	26CC	6.92
2-1/4" x 4"	Fits 2" Wide	12CC	6.67
2-1/2" x 4"	Fits 2-1/4" Wide	08CC	12.19
2-3/4" x 4"	Fits 2-1/2" Wide	07CC	10.91
3-3/16" x 4"	Fits 3" to 3-1/4" Wide	18CC	16.47

## APPLICATIONS

- Cultivators
- Subsoilers
- Direct Drills, Disc Drills and Air Drills
- Bed Formers
- Plows
- Power Harrows
- Packer Rollers

## CUSTOMER BENEFITS

- Weld Anywhere Onto A Point
- Greatly Increases Point Lifetime
- Boost Productivity And Output
- Significantly Reduce Downtime
- Protect Vital Machinery Parts
- Maintain Hardness Of Metal Points
- Cut And Weld With Standard Tools
- Cut Costs And Save Money

## KEY FEATURES

- Weldable
- Full Protection To Points
- Very High Impact Strength
- Superior Resistance To Chipping
- Resistance To Abrasion Directly Comparable To Tungsten Carbide
- Easy To Cut With Standard Tools
- Easy To Weld With Standard Tools

# FEROBIDE

WORKING LONGER, FASTER, DEEPER

## FEROBIDE - EXCLUSIVELY FROM HERSCHEL PARTS!

FEROBIDE uses a steel matrix to bond tungsten particles together. The unique forming process yields wear resistance similar to traditional tungsten carbide whilst allowing tiles to be easily cut and welded in place. This, combined with superior toughness, makes FEROBIDE the ideal choice for high impact and high abrasion situations.

By using FEROBIDE wear protection, farmers can significantly increase the working life of soil-engaging points, avoid lengthy downtime, and boost farm productivity.

### Typical Applications in Farming:

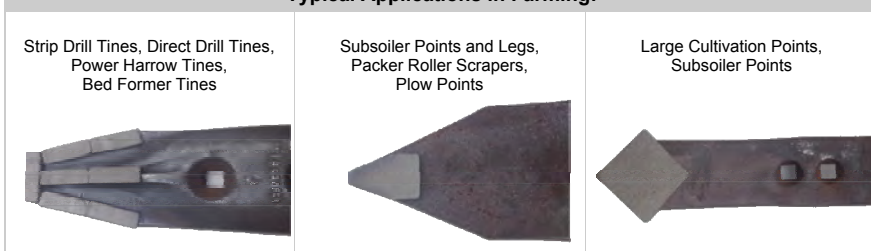

### FEROBIDE EX-SMALL/SMALL

Size	Description	Order No	List
Ex-Small	.32 x 1.57"	FERXSMALL	77.59
Small	.59 x 1.57"	FERSMALL	115.57

Sold in packs of 10. Pricing shown is for one pack.



### FEROBIDE MEDIUM

Size	Description	Order No	List
Medium	.98 x 1.57"	FERMED	192.60

Sold in packs of 10. Pricing shown is for one pack.



### FEROBIDE LARGE/EX-LARGE

Size	Description	Order No	List
Large	1.57 x 1.57"	FERLARGE	233.33
Ex-Large	.98 x 2.36"	FERXLARGE	286.80

Sold in packs of 10. Pricing shown is for one pack.

HARROW TINES

Replaces Number	Wire Gauge	Length A	Coil Width B	Coil Spacing C	Hole D	Application	Order No	List
143101	.375"	16-1/2"	9"	5"	1.69"	Degleman	T30-0001	11.18
1334	.375"	14-1/2"	7-1/4"	3-1/4"	1.75"	Flexi-coil	T30-0003	11.06
4341	.375"	16"	6-1/2"	Narrow	1.84"	Flexi-coil	T30-0004	13.66
P1546	.375"	11-5/16"	Single	Single	2.15"	Glencoe	T30-0006	7.72
8H-1110	.375"	12-3/4"	7-5/8"	Narrow	2.10"	Herman	T30-0007	14.04
H-1140	.375"	14-3/4"	5-3/4"	Narrow	2.10"	Herman	T30-0008	15.34
149781	.375"	11-1/4"	7-1/2"	3-1/2"	1.81"	Inland, Noble	T30-0009	9.87
N136767	.375"	13-1/2"	7-3/8"	3-1/8"	1.67"	John Deere, 1975-1981	T30-0010	10.87
N181162	.375"	12-3/4"	7-7/16"	3-1/8"	1.75"	John Deere, 1982-1985	T30-0011	11.53
1238	.375"	14"	2-5/8"	Single	2.25"	Kovar	T30-0012	7.89
N135002	.375"	12"	7-7/16"	3"	1.75"	John Deere, Before 1974	T30-0014	11.22
R-14-04710	.312"	10-3/4"	2-3/8"	Single	1.50"	Lindsay	T30-0015	4.63
L-14-04728	.312"	10-3/4"	2-3/8"	Single	1.50"	Lindsay	T30-0016	4.74
R-14-04752	.375"	11"	3-1/16"	Single	1.80"	Lindsay	T30-0017	7.11
L-14-04760	.375"	11"	3-1/16"	Single	1.80"	Lindsay	T30-0018	6.71
M1	.312"	11-1/2"	7-1/4"	3-1/2"	1.62"	Mattson	T30-0019	9.55
CH-113A	.375"	12-3/4"	6-1/2"	3-1/4"	1.50"	Midwest	T30-0023	10.71
H-1791	.375"	16-7/8"	9"	5"	1.69"	Morris	T30-0024	11.62
H-4087	.375"	16-7/8"	9"	5"	1.69"	Morris	T30-0025	13.53
R60000	.500"	20"	10"	5"	2.6"	Salford - NEW ITEM	HR60000	25.96
8H-1190S, 2070-28, BO21750, 4040-010	.562"	26"	12"	5-1/2"	2.5"	Summers - NEW ITEM	T30-1190	26.66
13419	.375"	12"	9-3/8"	5"	1.73"	Wilrich	T30-0027	10.41
16249, 16429	.375"	16"	9-3/8"	5"	1.63"	Wilrich	T30-0028	10.59

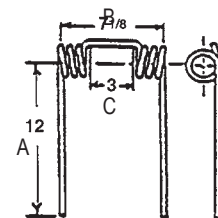

HARROW SHOES

Fits John Deere



Size	Replaces	Order No	List
51-3/8"	LH896	S31-0110	25.12

## ANHYDROUS FERTILIZER (NH3) KNIVES

### GROUND HOG KNIFE FRONT SWEPT SIDE MOUNT WITH ADALLOY CHROMIUM CARBIDE INSERT

- 1-7/8" Wide Foot Piece • 3/8" Tube w/63CC Tube Protector
- 33C Insert w/Sharp Leading Edge • Wears Sharp and Stays Sharp
- Foot Piece and Insert Work Together to Create a Tunnel or Expansion Chamber for the NH3.

Material Thickness: 1/2" x 2-1/2" x 15-1/8"  
Hole Spacing: 1-1/4" to 2-3/4" • Bolt Size: 1/2"



Description	Order No.	List
Standard	AK33-1	54.95
Single 3/8" NH3 Open End Tube	AK33-1-O	52.86

### BACK SWEPT, SIDE MOUNT KNIFE WITH ADALLOY CHROMIUM CARBIDE INSERT

AK42 series knives are ideal for side dress, maximum till or no till applications. Back swept designs penetrate better and seal well in all soil conditions.

Material Thickness: 1/2" x 2" x 14-3/8"  
Hole Spacing: 1-1/2" to 3" • Bolt Size: 1/2"



Order No.	List
AK42-1	43.66

### FRONT SWEPT, SIDE MOUNT KNIFE WITH ADALLOY #62 CHROMIUM CARBIDE INSERT

AK62 series knives have the Adalloy #62 insert which extends 6-1/2" up the front. It "shatters" hard soil and wears sharp. Adalloy tube protector extends 4-1/2" up the back.

Material Thickness: 1/2" x 2" x 14"  
Hole Spacing: 1-1/4" to 2-3/4" • Bolt Size: 1/2"



Description	Order No.	List
Sealer Only	AK62-0-3	4.37
Standard	AK62-1	40.66
3/8" NH3 Open End Tube w/Sealer	AK62-1S-O	53.05

### FIELD CULTIVATOR KNIFE WITH ADALLOY CHROMIUM CARBIDE INSERT

Note: For 3/8" Punched Shanks, Use "Reducer Head" Plow Bolts. AK82 Series Knives Apply Nitrogen 3" to 4" Deeper Than Sweeps And Seal Well In All Soils. Adalloy Insert Extends Life 3-5 Times Over Hardfaced Knives.

Material Thickness: 7/16" x 1-3/4" x 12-1/2"  
Hole Spacing: 1-3/4" to 1-7/8" • Bolt Size: 7/16"



Order No.	List
AK82-1	34.95

### FRONT SWEPT, SIDE MOUNT KNIVES WITH ADALLOY #92 CHROMIUM CARBIDE INSERT

AK92 series knives have the Adalloy #92 insert which extends 6-1/2" up the front. Dual tubes also available for liquid or gas.

Material Thickness: 1/2" x 2-1/2" x 15"  
Hole Spacing: 1-1/4" to 2-3/4" • Bolt Size: 1/2"



Description	Order No.	List
Standard	AK92-1	42.54
Standard with 3/8" Gas Tube w/Sealer	AK92-1S	49.90

## 1-Year Guarantee

On Everything We Offer! If it doesn't fit or work the way you expected, let us know. We will do what it takes to make it right!



## UNIVERSAL DOUBLE DISC ASSEMBLIES

Hardware included. 2 per carton.

### FLAT, 13-1/2" DIAMETER - "ADAMS" STYLE WITH TRASH SHIELD

For Crustbuster Red Box Drill, Crustbuster Silver Box Drill, Great Plains Drill, IHC Planter, JD Drill, JD 9300 Air Seeder w/cast shoes, Lilliston Drill, New Idea, Tye Drill, White 5100 Planter, Krause"

Order No.	List
20010548A	35.47 /Single No Hardware

### FLAT, 13-1/2" DIAMETER - "HERSCHEL" STYLE WITH DUST CAP

For Allis Chalmers Planter - Fertilizer, Case-IH Planter - Fertilizer & Seed, Crustbuster Red Box Drill, Crustbuster Silver Box Drill, Great Plains Drill, John Deere Drill, John Deere 7000, 7100 Planter-Fertilizer, John Deere 7200, 7300 Planter-Fertilizer, Lilliston, (Melroe) Drill, Morris Drill, Tye Drill, White 3400 & 5100 Planter - Fertilizer & Seed. MF 424, 425.

Order No.	List
B45-3194	76.28 /box of 2
B45-3194A	36.71 /Single No Hardware



### FLAT, 15" DIAMETER - "ADAMS" STYLE WITH TRASH SHIELD

For Great Plains, White 6000 series, John Deere 7000, 7100, 7200, 7300, 1700 Max Emerge 2 & Max Emerge Plus Planters - Seed, Kinzie Planter - Seed, New Idea Planter - Seed. 3mm thick.

Order No.	List
20010575A	43.47 /Single No Hardware

### FLAT, 15" DIAMETER - "HERSCHEL" STYLE WITH DUST CAP

For Great Plains 1999 & after, White 6000 series, John Deere 7000, 7100, 7200, 7300, 1700 Max Emerge 2 & Max Emerge Plus Planters - Seed, John Deere 7200, 7300 Planter - Seed, Kinzie Planter - Seed, New Idea Planter - Seed. 5/8" ID bearing.

Order No.	List
B45-3195	76.28 /box of 2
B45-3195A	34.68 /Single No Hardware

## JOHN DEERE AND KINZIE PLANTER SEED DISC OPENERS

Made In The USA. High Quality Boron Steel.  
Includes Hub & Bearing. Order Dust Cap Separately(Listed Below)

*Heavy Duty Seed Opener Assembly. 3.5MM thick, 15" Diameter*

Application	Replaces	Order No	List
John Deere 7000, 7100 Max Emerge, 7200, 7330, and 1700 Series Planters. Kinzie Planters except 3000 series.	AA53860 GA8324	HAA53860	50.00
John Deere 7000, 7100 Max Emerge, 7200, 7330, and 1700 Series Planters. Kinzie Planters except 3000 series. Double row bearing.	AA65248	HAA65248	48.75

*Standard Seed Opener Assembly. 3MM thick, 15" Diameter*

Application	Replaces	Order No	List
John Deere 7000, 7100 Max Emerge, 7200, 7330, and 1700 Series Planters. Kinzie Planters except 3000 series.	AA55927 GA2013	HAA55927	35.47



HAA53860

## FERTILIZER DISC OPENERS

Fits JD 7000, 7100, 7200, 7300. Dust cap required pn 0475-02935\*  
\*Herschel assembled in the USA.

**MADE IN THE USA!** Made From High Quality Boron Steel.  
Includes hub & bearing.

13.5" x 2.54mm Assembly

Order No	List
HAA57466	46.12

## UNIVERSAL COVERING CHAIN

Heavy Gauge Steel Welded 3-Ring Construction



Order No	List
C30-0050	6.86

## NON-CAST DRILL POINTS

Heat-treated. Made from 1080 High Carbon Steel.

**Made In The USA**



Description	Application	Order No.	List
Plain, 1/4" x 2"	John Deere	JD02	8.16
Plain, 5/16" x 1-3/4" x 11", Bolt Size 3/8"	Crustbuster	CC06	10.36
Inserted, 5/16" x 1-3/4" x 11", Bolt Size 3/8"	Crustbuster	CC06I	10.36

## CAST DRILL POINTS - A SERIES

Adalloy Chromium Carbide Point. Improved Ground Penetration.

**Made In The USA**



Application	Bolt Size	Order No.	List
IHC Eagle Beak 7400, 8500 etc. Bolts, Roll Pins & Nut included.	1/4" x 1-1/4"	11CC	9.53
John Deere Only. 9300 or Earlier	1/4" Flat	73CC	11.04
John Deere 9400 JD.	Roll Pin	75CC	10.81
John Deere, Crustbuster, AcraPlant, Great Plains, Mighty Handy		98CC	8.96
John Deere, Crustbuster, AcraPlant, Great Plains, Mighty Handy, w/V Groove		99CC	11.73

## 13-1/2" FLAT OEM STYLE DOUBLE DISC ASSEMBLIES

Application	Disc Assembly w/Hardware (2/Carton)		Blade Only		Bearing		Trash Shield or Dust Cap		Seal		Seal Mtg. Spacer		Washer/Spacer	
		List	Each	List	Each	List	Each	List	(10/Bag)	List	(10/Bag)	List	(10/Bag)	List
John Deere*			B45-3202	19.18				Not Req.				Not Req.		
Great Plains***			B45-3048	15.72				Use OEM		Not Req.		Not Req.		Not Req.
IHC**	B45-3089	109.57	B45-3047	22.34					S16-0232	12.90				Not Req.
Marliss***			DD135FDD**	17.87	GP205	12.06	20010536	5.57		Not Req.		Not Req.		

\* Fits: B, B-A, B-B, B-C, D-C, DF-B, DF-C, DR-A, DR-B, FB-B, FB-C, LL-A, LL147, LL166, PD-A, 450, 515, 520, 770, 780, 8100, 8200, 8250, 8300, 8500, 8550, 9300, 9350, 9400, 9450. \*\*Will not work on Marliss drills with bolt-on hubs. \*\*\*Note: On IHC applications, the diameter of the disc assembly is 13-7/8". Fits 510, 5100, 620, 6200, 5200 \*\*\* Fits: All Models

## 13" CONCAVE OEM STYLE SINGLE DISC ASSEMBLIES

Application	Disc Assembly w/Hardware (2/Carton)		Blade Only		Bearing		Trash Shield or Dust Cap		Seal	
		List	Each	List	Each	List	Each	List	(10/Bag)	List
John Deere (Internal 1/2" threads). Fits: B, B-A, B-B, B-C, D-C, DF-B, DF-C, DR-A, DR-B, FB-B, FB-C, LL-A, LL147, LL160, LZ-B, PD-A, 8100, 8200, 8250, 8300, 8350. Replaces AM12419 & AN161227	B45-3410	88.38	B45-3046	18.29	0475-02237	6.42		Not Req.		
John Deere, New Style. (External 5/8" threads) Fits: 450, 515, 8100, 8200, 8250, 8300, 8350, 8500, 8550	B45-3084	107.69	B45-3046	18.29	0475-02237	6.42		Not Req.		
Massey/Oliver										

## 14" CONCAVE OEM STYLE SINGLE DISC ASSEMBLIES

Application	Disc Assembly w/Hardware (2/Carton)		Blade Only		Bearing		Trash Shield or Dust Cap		Seal		Seal Mtg. Spacer	
		List	Each	List	Each	List	Each	List	(10/Bag)	List	(10/Bag)	List
Crustbuster					0475-02237	6.42		Not Req.				
IHC	B45-3408*	114.64	B45-3045	18.64				Not Req.	S16-0232	12.90		
IHC, (Heavy Duty). 5/8" Bolt/Nut								Not Req.				
John Deere, Old Style (Internal 1/2" Threads) Fits: B-A, B-B, B-C, D-C, DF-8, DF-C, DR-A, DR-B, FB-B, FB-C, 8100, 8200, 8250, 8300, 8350. AN161227.	B45-3409	91.73	B45-3045	18.64	0475-02237	6.42		Not Req.				
John Deere, New Style (External 5/8" Threads) Fits: 450, 515, 8100, 8200, 8250, 8300, 8350, 8500, 8550	B45-3902	106.45	B45-3045	18.64	0475-02237	6.42		Not Req.				

## DRILL DISC BLADES

Description	Replaces Number	Application	Disc Assembly Used In	Thick-ness	Center Hole	Bolt Hole	Bolt Circle	Order No.	List
14" Concave	PD1413	JD, IHC	B45-3408 B45-3409 B45-3902	.094	1.280	(6).265	2.500	B45-3045	18.64
13" Concave	PD1313	JD	B45-3410 B45-3084	.094	1.280	(6).265	2.500	B45-3046	18.29
13-7/8" Flat	603013R2	IHC	B45-3089	.080	1.370	(6).265	2.500	B45-3047	22.34
13-1/2" Flat	820-002C	Great Plains	B45-3090	.100	1.580	(6).224	2.750	B45-3048	15.72
13-1/2" Flat	K202M	John Deere	B45-3200	.089	1.171	(6).265	2.500	B45-3202	19.18
13-1/2" Flat		Universal	20010548	.118	1.562	(6).265	2.875	DD135FDD	17.87
15" Flat		JD, Kinze, NI Planter	20010575	.118	1.562	(6).265	2.875	JDA22991	17.27
18" Flat	N283804	JD 750, 1850, 1560, 1860 No Till Grain Drills		.203	3.031	(4).406	4.375	B45-3049	32.88
13-1/2" Raised Center	N164594			.100	.472			B45-3500	15.02



B45-3045



B45-3049

**DRILL DISC BEARINGS**

Replaces Number	Bore Size	Application	Order No.	List
Z9504AB	.750	JD, B45-3409, B45-3410, B45-3084, B45-3902	0475-02237	6.42
	.750	Marliss Double Discs	GP205	12.06
	.629	Universal Double Discs, 13-1/2" & 15", 20010548, 2000575	GP205DDS	10.06
203KRR2	.635	JD B45-3500	B15-0200	11.58
N/A		JD 150, 1850, 1560, 1860. Includes: 2 Cones, 2 Cups, 2 Seals, 2 Retainers, 1 O-Ring	B15-0750	40.57



**SEED BOOTS**

Fits JD 750 Grain Drill & 1850 Air Seeder

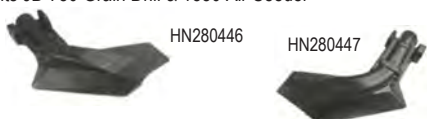

OEM No	Description	Order No	List
N280446	Right Hand	HN280446	40.66
N280447	Left Hand	HN280447	40.66

**NEOPRENE SEED AND FERTILIZER TUBES**

Lower Diameter : 1-1/4"  
Bolt OD: 1.25"



Working Length	Upper Diameter	Application	Order No.	List
17"	1-9/16"	JD Grain Drills	T82-0016	7.89
14"-30"	2-1/4"	Universal w/Eyelet	T82-0018	18.70

**DUST CAPS AND TRASH SHIELDS**

Package Qty: Each



Description	Application	Order No	List
Dust Cap, Plastic	Univ. B45-3194, B45-3195	0475-02935	1.24
Trash Shield	Marliss 20010552	20010536	5.57

**HARDWARE**



B55-0226

Size	Description	Application	Pkg Qty	Order No	List
5/8" x 1-1/2" LH	Bolt Only	Universal Adams Style	Each	20010335	4.72

**JOHN DEERE GRAIN DRILL REPLACEMENT PARTS**

Fits 750 Grain Drills & 1850 Air Seeders

OEM Number	Description	Order No.	List
AN212132	Gauge Bearing	HAN212132	9.53
AA38447	Closing Wheel Assembly	HAA38447	34.55
N280447	SEed Boot LH	HN280447	40.66
AN213544	Seeder Blade Hub	HAN213544	41.57
N/A	Disc Bearing Kit	B15-0750	40.57
N214190	18" Blade	B45-3049	32.88

HA22884



HAN213544



B15-0750

# ACCESSORIES

Lead Free Enamel. Tractor & Implement paint is for machinery only. Not intended for use on toys, fence gates, or other objects. Paints must be shipped via UPS Ground ONLY. **Oil Based**



## Sandable Gray Primer

High quality sandable acrylic primer can be used with a wide range of topcoats. Fast filling and low shrinking. Easy wet or dry sanding. 10-15 min dry to touch, 1 hour to sand/ topcoat. Excellent adhesion and holdout. Superior resistance to rust and corrosion. Covers approximately 300 sq ft per gallon.

Aerosol Order No. A 972608 10.06  
Gallon Order No. A 952608 69.11



*Fast Drying!*

Description/Size	Order No.	List
------------------	-----------	------

### ALLIS CHALMERS PERSIAN ORANGE 1960 & Older

Gallon	A 951001	50.08
Quart	A 961001	19.02
12 oz. Aerosol	A 971001	6.56

### ALLIS CHALMERS PERSIAN II

(1961 & Later)

Gallon	A 951002	50.08
Quart	A 961002	19.02
12 oz. Aerosol	A 971002	6.56

### ALLIS CHALMERS CREAM

Quart	A 961003	21.49
Aerosol	A 971003	12.38

### ALLIS CHALMERS CORP. ORANGE 200, 7000, 8000 Series

Gallon	A 951004	50.08
Quart	A 961004	19.02
12 oz. Aerosol	A 971004	6.56

### ALUMINUM

Gallon	A 952503	50.08
Quart	A 962503	19.02
12 oz. Aerosol	A 972503	6.56

### Aluminum, High Temp

12 oz. Aerosol	A 972507	9.53
----------------	----------	------

### BLACK

#### Black Gloss

Gallon	A 952501	50.08
Quart	A 962501	19.02
12 oz. Aerosol	A 972501	6.56

#### Black, High Temp.-Flat

12 oz. Aerosol	A 972506	9.53
----------------	----------	------

### CASE FLAMBEAU RED

Gallon	A 951501	50.08
Quart	A 961501	19.02
12 oz. Aerosol	A 971501	6.56

### CASE DESERT SAND

Gallon	A 951502	81.46
Quart	A 961502	30.93
12 oz. Aerosol	A 971502	11.55

Description/Size	Order No.	List
------------------	-----------	------

### CATERPILLAR YELLOW (1980 To Present)

Gallon	A 951101	50.08
Quart	A 961101	19.02
12 oz. Aerosol	A 971101	6.56

### COCKSHUTT YELLOW

Quart	A 961201	28.29
12 oz. Aerosol	A 971201	9.29

### COCKSHUTT RED

Quart	A 961202	22.98
12 oz. Aerosol	A 971202	9.29

### FORD BLUE

Gallon	A 951306	50.08
Quart	A 961306	18.93
12 oz. Aerosol	A 971306	6.56

### FORD GRAY (8N, NAA, 600, 700, 800, 900 Series)

Gallon	A 951304	49.83
Quart	A 961304	19.02
12 oz. Aerosol	A 971304	6.56

### FORD LIGHT GRAY (2000 - 4000)

Gallon	A 951305	50.08
Quart	A 961305	19.02
12 oz. Aerosol	A 971305	6.56

### FORD DARK GRAY (9N, 2N)

Gallon	A 951303	50.08
12 oz. Aerosol	A 971303	6.56

### FORD RED (Orange) 2000 - 4000

Quart	A 961302	18.93
12 oz. Aerosol	A 971302	6.53

### FORD RED (8N, NAA)

Gallon	A 951301	49.83
Quart	A 961301	19.02
12 oz. Aerosol	A 971301	6.56

### FORD WHITE

12 oz. Aerosol	A 971307	8.62
----------------	----------	------

Description/Size	Order No.	List
------------------	-----------	------

### FARMALL RED (Prior To 1981)

Gallon	A 951402	50.08
Quart	A 961402	19.02
12 oz. Aerosol	A 971402	6.56

### IH/FARMALL 1939-1947 EQUIPMENT BLUE

Quart	A 961405	19.02
12 oz. Aerosol	A 971405	6.56

### INTERNATIONAL HARVESTER (1981 - Current)

Gallon	A 951403	50.08
Quart	A 961403	19.02
12 oz. Aerosol	A 971403	6.56

### IH HARVESTER WHITE

Quart	A 961404	19.02
12 oz. Aerosol	A 971404	6.56

### J.D. 2-CYL. CLASSIC GREEN All 2-Cylinder Tractors

Gallon	A 951701	50.08
Quart	A 961701	19.02
12 oz. Aerosol	A 971701	6.56

### JOHN DEERE GREEN (Ag Green)

Gallon	A 951702	50.08
Quart	A 961702	19.02
12 oz. Aerosol	A 971702	10.59

### JOHN DEERE YELLOW (Ag Yellow)

Gallon	A 951703	50.08
Quart	A 961703	19.02
12 oz. Aerosol	A 971703	6.56

### J.D. INDUSTRIAL YELLOW

12 oz. Aerosol	A 971704	9.29
----------------	----------	------

### KUBOTA ORANGE (1990 & Newer)

Gallon	A 951901	50.08
Quart	A 961901	18.93
12 oz. Aerosol	A 971901	6.56

Description/Size	Order No.	List
<b>FERGUSON GRAY</b>		
Gallon	A 952001	71.08
12 oz. Aerosol	A 972001	9.27

<b>MASSEY FERGUSON LIGHT GRAY</b>		
Gallon	A 952004	69.43
Quart	A 962004	26.39
12 oz. Aerosol	A 972004	12.38

<b>MF METALLIC FLINT GRAY</b>		
Gallon	A 952003	64.95
Quart	A 962003	25.47
12 oz. Aerosol	A 972003	7.76

<b>MASSEY FERGUSON RED</b>		
Gallon	A 952002	50.08
Quart	A 962002	19.02
12 oz. Aerosol	A 972002	6.56

<b>MASSEY HARRIS RED</b>		
Gallon	A 952005	58.58
Quart	A 962005	22.27
12 oz. Aerosol	A 972005	9.29

<b>MASSEY HARRIS STRAW YELLOW</b>		
Quart	A 962006	45.31
12 oz. Aerosol	A 972006	12.38

<b>McCORMICK-DEERING RED</b>		
Gallon	A 952102	50.08
12 oz. Aerosol	A 972102	6.56

<b>MINN-MOLINE PRAIRIE GOLD</b>		
Gallon	A 952201	96.04
Quart	A 962201	36.50
12 oz. Aerosol	A 972201	9.29

<b>MINNEAPOLIS-MOLINE RED</b>		
Quart	A 962202	20.36
12 oz. Aerosol	A 972202	9.29

<b>NEW HOLLAND RED</b>		
Gallon	A 952302	50.08
12 oz. Aerosol	A 972302	6.56

Description/Size	Order No.	List
<b>NEW HOLLAND YELLOW</b>		
Gallon	A 952301	50.08
12 oz. Aerosol	A 972301	6.56

<b>OLIVER GREEN (Early) 1938-44</b>		
Gallon	A 952402	50.08
Quart	A 962402	19.02
12 oz. Aerosol	A 972402	6.56

<b>OLIVER MEADOW GREEN - 1952 &amp; Later</b>		
Gallon	A 952403	50.08
Quart	A 962403	19.02
12 oz. Aerosol	A 972403	6.56

<b>OLIVER WHITE - Clover White</b>		
Quart	A 962401	28.91
12 oz. Aerosol	A 972401	9.29

<b>OLIVER RED</b>		
Quart	A 962404	23.40
12 oz. Aerosol	A 972404	9.29

<b>OLIVER YELLOW</b>		
Quart	A 962405	36.26
12 oz. Aerosol	A 972405	9.29

<b>WHITE GLOSS</b>		
Gallon	A 952502	50.08
Quart	A 962502	19.02
12 oz. Aerosol	A 972502	6.56

<b>HIGH TEMPERATURE PAINT</b>		
12 oz. Aerosol		
Black	A 972506	9.53
Aluminum	A 972507	9.53

<b>PRIMERS</b>		
<b>RED OXIDE PRIMER</b>		
Gallon	A 952504	50.08
Quart	A 962504	19.02
12 oz. Aerosol	A 972504	6.56

<b>GRAY PRIMER</b>		
Gallon	A 952505	50.08
Quart	A 962505	19.02
12 oz. Aerosol	A 972505	6.56



**ACRYLIC HARDENER**  
Can be used as additive to improve the hardness of the paint film. In most cases, an increase in chemical resistance and improvement of gloss will occur. Provides chip resistant high gloss finish. 1/2 pint. Mix ratio: 1/2 pint to 1 gallon of paint.

Order No.	List
A 972508	22.87

## PROPANE TANK PAINT



Oil based formula with "Fortified" Ultra Violet Arrestors for longer lasting gloss white finish. Superior gloss retention and weather protection for the most severe conditions. Rust resistant enamel designed for use on propane tanks. Brush, roller or spray application.

Order No.	List
A 941021	56.37



**ACRYLIC LACQUER CLEAR COAT**  
Use for a "Water Clear" non-yellowing gloss coat on tractors and equipment. Spray application recommended. Provides additional protection and fade resistance.

*Use over properly cured tractor, equipment and industrial enamel.*

Aerosol Order No.	A 972609	7.76
Quart Order No.	A 962609	25.36
Gallon Order No.	A 952609	66.70

## BULLDOG® TUBE MOUNT JACKS

J01-0190



J01-0160



### SIDE WIND

Load Capacity	Retracted Size	Extended Size	Clearance	Travel	Order No.	List	
2000 lbs.	11-1/4"	21-1/4"	6-1/4"	10"	J01-0105	110.17	
Replacement Tube Only						J01-0018	6.61
2000 lbs.	14-1/2"	29-1/2"	12"	15"	J01-0190	124.92	
Replacement Tube Only						J01-0018	6.61
5000 lbs.	15"	30"	6-1/4"	15"	J01-0110	134.97	
Replacement Tube Only						J01-0018	6.61
7000 lbs.	15-3/4"	30-3/4"	6-1/4"	15"	J01-0185	124.48	

### TOP WIND

Load Capacity	Retracted Size	Extended Size	Clearance	Travel	Order No.	List
2000 lbs.	11-1/4"	21-1/4"	7-1/4"	10"	J01-0120*	79.91
2000 lbs.	14-1/2"	29-1/2"	13-1/4"	15"	J01-0125*	101.83
5000 lbs.	11-1/4"	21-1/4"	7-1/4"	10"	J01-0160	94.44
5000 lbs.	14-1/2"	29-1/2"	13-1/4"	15"	J01-0165	107.68
7000 lbs.	10-3/4"	20-3/4"	8-1/2"	10"	J01-0170	103.55

### \* REPLACEMENT PARTS FOR JACK NO. J01-0120 and J01-0125

Replacement Jack Handle	J01-0010	8.88
Replacement Tube Section	J01-0015	6.44

## A-FRAME JACKS - TOPWIND

J01-0230



J01-0235



Load Capacity	Retracted Bracket Height	Extended Bracket Height	Top Clearance Height	Travel	Order No.	List	
2000 lbs.							
with foot	8"	23-1/4"	14-1/2"	15"	J01-0230	20.14	
5000 lbs.							
without foot	8"	23-1/4"	14-1/2"	15"	J01-0235	28.15	
Foot for J01-0135. Includes hardware. Fits 2" tube. 1.7" tall						J01-0250	6.22

J01-0250

## IMPORT IMPLEMENT JACKS

J01-0225



J01-0210



Greaseable gears. Includes weldable mating pipe end, pin and chain. Durable powder coat and zinc finish

### TUBE MOUNT SIDEWIND

Load Capacity	Travel	Retracted Bracket Height	Extended Bracket Height	Top Clearance Height	Order No.	List
2000 lbs.	10"	10-7/8"	21"	5-7/8"	J01-0205	30.02
2000 lbs.	15"	14-3/4"	29-7/8"	12"	J01-0290	33.12
5000 lbs.	15"	14-3/4"	30"	6-7/8"	J01-0210	44.48

### TUBE MOUNT TOPWIND

Load Capacity	Travel	Retracted Bracket Height	Extended Bracket Height	Top Clearance Height	Order No.	List
2000 lbs.	10"	11-1/4"	21-3/8"	6-7/8"	J01-0220	30.02
2000 lbs.	15"	15"	30-1/4"	7-3/4"	J01-0225	33.12
5000 lbs.	10"	11-1/4"	21-3/8"	6-7/8"	J01-0260	44.48
5000 lbs.	15"	15"	30-1/4"	7-3/4"	J01-0265	44.48

## 48" HI-LIFT FARM JACK



Width:	5"
Height:	50.75"
Depth:	9.63"
Rated Load:	4660 lb.s.
Tested Load:	7000 lbs.
Winching:	5000 lbs.
Max Lift Height:	36.63"
Min. Lift Height:	4.5"

Order No.	List
J01-0485	124.89

Made in the USA

## WELD-ON - BRACKET MOUNT

Lift Capacity: 2000 lbs  
Travel: 10"  
Retracted Bracket Height: 10-1/4"  
Extended Bracket Height: 20-3/8"  
Top Clearance Height: 7-3/4"

Order No. J01-0215 28.15

## SIDE WIND TRAILER JACK

Load Capacity: 1000 lbs with 6" diameter caster  
Retracted Size: 23-1/4"  
Clearance: 12.7"  
Travel: 10"



Order No. J01-0217 43.09



**R-Series®**

This model is designed to retrofit PAR36 work lights. The R-Series fits into most round light cavities on over 400 different models of tractors and is quick and easy to upgrade any machine in your fleet. 4-1/2" diameter.



Lumens Actual	Shape	Pattern	Order No.	List
1800	Round	Flood	BRD1800	122.73

- Lifetime Warranty
- Made In USA
- 3X More Housing Surface For Maximum Cooling.
- Up To 50,000+ Hour Lifespan
- 9 - 36 Volt
- Reverse Polarity
- 20' Wire Harness With Rocker Switch
- Waterproof Deutsch Connector
- -40° F to 145° F Operating Temp
- Bracket Included

**D-Series®**

The D-Series lights produce extremely high output while consuming very little power. Its compact size and shape allows the light to fit almost anywhere and can be used in virtually any lighting application. Heavy duty and flush mount.

*\*Available In Sets Of 2 For Additional Savings!\**

Size	Lumens		Shape	Pattern	Order No.	List
	Actual					
5" x 3-5/8"	1568		Square	Spot	LSS1568	112.50



**SR-M® and SR-Q®**

The very compact yet efficient SR-M is ideal for any lighting need you might have. The SR-Q has a sleek, low profile configuration allowing the light to fit almost anywhere, while providing you with the same output as the D-Series.

Size	Lumens		Shape	Pattern	Order No.	List
	Actual					
4-15/16" x 1-13/16"	1568		Rectangle	Flood	LRECF1568	122.73



LRECF880



LRECF1568



- *Made In USA*
- *Meets or Exceeds OEM Specifications.*
- *Industry Leading Performance And Reliability.*
- *Designed To Withstand The Rigors And Abuse of Agriculture, Off-Road And Construction.*
- *Honest Real-World Performance Ratings.*

This model is designed to retrofit PAR36 work lights. They are a superior upgrade over bulb-based work lights.

- Most popular model of replacement LED.
- PAR36 standard size fits numerous manufacturers and models.
- Broad applications across wide array of equipment.

Size	Lumens Actual	Shape	Pattern	Order No.	List
4.5"	1020	Round	Flood	BRF1020	<b>102.78</b>
4.5"	1020	Round	Trap	BRT1020	<b>102.78</b>



BRF1020



BRT1020

This model is a perfect retrofit for GE H4360-12V sealed beams. The durable construction and bright, white light produced by state-of-the-art LED's combine to make this model brighter and more reliable than any bulb-based 5" x 2" light.

- Popular model for many direct-fit, upgrade tractors.
- Replaces John Deere #R161288

Size	Lumens Actual	Shape	Pattern	Order No.	List
5" x 2"	1000	Rectangle		LREC998	<b>107.33</b>

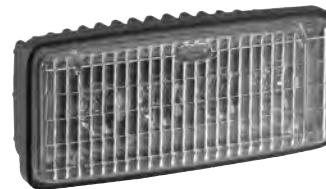

A slimmer and more powerful version than most PAR36 work lights. The polycarbonate housing and lens make it one of the most durable work lights on the market.

- Another unique torture tested light

Size	Lumens Actual	Shape	Pattern	Order No.	List
4.5"	860	Round	Flood	LRF860	<b>88.45</b>
4.5"	860	Round	Trap	LRT860	<b>88.45</b>





• **AGRICULTURAL/INDUSTRIAL STRENGTH** • **OE FORMULAS** • **SATISFACTION GUARANTEED**



**CHAIN & CABLE LUBE**  
Penetrates rapidly to reduce friction & wear. Resists rust & corrosion. Use on all chain, cables & hinges.

Order No. A10510 List  
5.40



**BRAKE & PARTS CLEANER**  
Safely removes fluid, grease, oil & contaminants. Use on all brake parts. Cleans & degreases without leaving residue.

Order No. A10515 List  
4.89



**GLASS CLEANER**  
Foaming cleaner. Cleans quickly & easily. Cleans glass, mirrors, plastic & Stainless steel.

Order No. A10520 List  
4.10



**CARB & CHOKE CLEANER**  
Remove internal deposits. Use on all engines. Helps eliminate stalling & rough idling.

Order No. A10525 List  
4.85



**BELT DRESSING/CONDITIONER**  
Use on fan & V-belts, rubber belts & belt drives. Reduces slippage & noise. Cleans & Lubricates for Longer life.

Order No. A10530 List  
6.11



**GRAPHITE LUBRICANT**  
Non-stick. Reduces wear. Long lasting lubrication and protection.

Order No. A10535 List  
7.43

# ACCESSORIES

## ASSORTED PINS

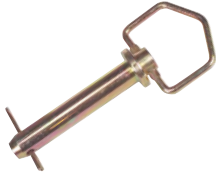

### COLD FORGED HITCH PINS

Pin Dia.	Usable Length	Order No.	List
1/2"	3-1/2"	A 693051*	2.94
5/8"	4-1/4"	A 757039	3.74
7/8"	6-1/4"	A 688572	5.51

\* swivel handle

### HOT FORGED HITCH PINS



Pin Dia.	Usable Length	Order No.	List
1/2"	3-1/2"	P34-0055	2.82
5/8"	3-3/4"	P34-0060	3.31
5/8"	6"	P34-0080	4.01
3/4"	4"	P34-0065	3.88
3/4"	6-1/4"	P34-0085	3.44
7/8"	4-1/4"	P34-0070	4.15
7/8"	6-1/2"	P34-0090	5.19
1"	4-1/2"	P34-0075	5.50
1"	6-3/4"	P34-0095	5.98
1-1/8"	7"	P34-0100	10.99
1-1/4"	7"	P34-0105	19.58

### RED HEAD FORGED HITCH PINS

Pin with plastisol coated pull ring and hairpin.



A 908111

Pin Dia.	Usable Length	Order No.	List
1/2"	3-5/8"	A 908111	3.78
5/8"	5-1/2"	A 908145	7.23
3/4"	6-1/2"	A 757047	6.03
7/8"	6-1/2"	A 757054	7.71
1"	8"	A 757055	10.17
1.125"	8-5/8"	A 757056	12.80
1.25"	8-5/8"	A 757057	14.52
1.5"	8-5/8"	A 757058	21.26

### SAFETY PINS



A 842302

Pin Dia.	Usable Length	Order No.	List
1/2"	4"	A 842302	4.12
3/4"	4-1/4"	A 669507	5.34
7/8"	6"	A 842245	7.23

## SAFETY EQUIPMENT

A 400001



### SLOW MOVING VEHICLE EMBLEMS

Designed for use on slow-moving vehicles for both day and night. Weatherproof and approved by the National Institute for Farm Safety, National Safety Council and many other safety organizations.

Description	Order No.	List
26" mounting pole assembly (socket not included)	A 317867	5.02
SMV mounting pack. Contains bolts, spade and socket.	400001	8.34

## ASSORTED CLEVIS

SCREW PIN Max WWI - Maximum Working Weight



### CLEVIS

Pin Diam.	Body Diam.	Usable Length	Max WWI	Order Number	List
5/8"	1/2"	1-15/16"	6500	A 986125	6.07

### TWISTED CLEVIS



Pin Diam.	Body Diam.	Usable Length	Max WWI	Order Number	List
1"	1"	5"	25000	C44-0110	33.19

### STRAIGHT CLEVIS



A 908251

Pin Diam.	Body Diam.	Usable Length	Max WWI	Order Number	List
1/2"	5/8"	3-1/4"	6000	A 908251	11.62
1"	1"	5-5/16"	25000	C44-0070	32.44

### GENERAL PURPOSE CLEVIS



A 130716

Pin Diam.	Body Diam.	Usable Length	Max WWI	Order Number	List
7/16"	3/8"	1-1/4"	2000	C44-0010	3.59
3/4"	3/4"	6-3/16"	10000	A 130716	17.26

## LYNCH PINS

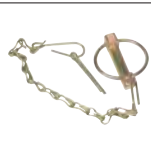

### LOCKING LYNCH PINS

Description	Diam.	Order No.	List
Locking lynch pin, plain. Pkg. 5	1/4"	P34-0185B	1.41
Forged lynch pin with snap-lock ring. Pkg. 5	7/16"	P34-0180B	1.88

## DOUBLE LOK. HITCH PINS

Grade 5 pin, double locking, powder coat on pin and handle, quick release handle.

Order No.	Description	List	Order No.	Description	List
HP700421	5/8" x 4-1/2"	22.73	HP700452	1" x 6"	31.42
HP700431	3/4" x 4-1/2"	23.99	HP700492	1-1/2" x 8"	42.31
HP700432	3/4" x 6"	26.15			
HP700441	7/8" X 4-1/2"	26.15			
HP700442	7/8" x 6"	26.88			



## RATCHET & TURNBUCKLE JACKS

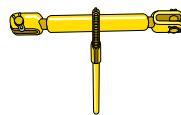

Replaces hydraulic cylinders or screw jacks in uses where infrequent adjustments are needed. All steel. 1-1/4" diameter clevis pin. 20" closed, 28" open.

Description	Order No.	List
Turnbuckle - 1-1/4" NC threads	J01-0270	63.99

## TOPLINK & LIFT ARM BUSHINGS

Type	Fits Pin Cat.	Fits Arm Cat.	O.D.	I.D.	Length	Order Number	List
Lift Arm	1	2	1-1/8"	7/8"	1-3/8"	B82-0290B	1.15
Lift Arm	1	2	1-1/8"	7/8"	1-3/4"	B82-0210B	0.74
Lift Arm	2	3	1-7/16"	1-1/8"	2-3/4"	B82-0270B	3.22
Lift Arm	2	3	1-7/16"	1-1/8"	3-1/4"	B82-0280B	3.76
Top Link	1	2	1"	3/4"	2"	B82-0230B	1.15
Top Link	2	3	1-1/4"	1"	2"	B82-0240B	1.44

## LIFT ARM DRAW PINS

Style 1 - Adjustable Shoulder



Style 2 - Fixed Shoulder



Style 3 - Roll Pin

Cat	Shoulder	Pin Diam.	Usable Length	Overall Length	Thread Diam.	Order No.	List
0	Adj.	5/8"	1-1/4"	4"	5/8"	P34-0200	2.54
1	Adj.	7/8"	1-5/8"	5"	7/8" NF	P34-0046	3.57
1	Fixed	7/8"	1-3/4"	5-1/2"	7/8" NF	P34-0165	2.70
1	Adj.	7/8"	2"	6-3/16"	7/8" NF	P34-0195	4.63
1	Fixed	7/8"	2-1/4"	6-5/8"	7/8" NF	P34-0203	3.78
1 to 2	Adj.	7/8" - 1-1/8"	2-1/16"	8"	1" NF	P34-0035	10.81
1 to 2	Adj.	1-1/8"	1-3/4"	5-1/8"	7/8" NF	P34-0115	4.68
1 to 2	Fixed	1-1/8"	2-1/4"	5-7/8"	7/8" NF	P34-0120	8.34
2	Adj.	1-1/8"	1-3/4"	6-1/4"	1-1/8"	P34-0170	8.19
2	Fixed	1-1/8"	2"	6-1/4"	1-1/8" NF	P34-0175	7.19
2 to 1	Fixed	1-1/8" - 7/8"	2-1/4"	6-1/8"	1-1/8" NF	P34-0202	10.55
2	Roll Pin	1-1/8"	5"	6-3/4"	-	P34-0292	7.36
2	Roll Pin	1-1/8"	6-1/8"	7-3/4"	-	P34-0293	9.32
2	Roll Pin	1-1/8"	7-1/2"	9"	-	P34-0294	9.41

## TOP LINK REPAIR ENDS



### TOP LINK REPAIR ENDS

Cat.	Side	Thread Length	Thread Dia.	Order No.	List
1	Right	6"	1-1/8"	L35-0152	12.94
2	Right	6-1/2"	1-1/8"	L35-0111	14.29
2	Left	6-1/2"	1-1/8"	L35-0120	14.60
2	Right	5-1/2"	1-1/4"	L35-0126	16.17
2	Left	5-1/2"	1-1/4"	L35-0125	16.17

## FORGED TOP LINKS

All Top Links Include Handles.



A 890657

Cat.	Pin Hole Size	Thread Diam.	Body Length	Closed Length	Open Length	Order No.	List
0	5/8"	3/4" NC	7-1/2"	11"	16"	A 890657	23.20
1	3/4"	1-1/8" NC	13-1/4"	18"	28"	L35-0189	31.56
1	3/4"	1-1/8" NC	17"	20-1/2"	29"	A 825836	29.45
1	3/4"	1-1/8" NC	20"	25"	35"	L35-0176	35.46
1	3/4"	1-1/8" NC	24"	29"	39"	L35-0177	34.20
1 & 2	3/4", 1"	1-1/8" NC	16"	21"	32"	L35-0178	37.10
2	1"	1-1/8" NC	20"	24"	36"	A 825847	37.02
2	1"	1-1/4" NC	20"	27"	37"	L35-0183	50.10

## REPLACEMENT BALLS & SOCKETS

### LIFT ARM/TOP LINK REPLACEMENT BALLS



A = Pin Hole Size  
B = Length Thru Bore  
C = Sleeve Width

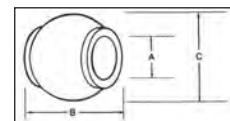

Type	Cat.	A	B	C	Order No.	List
Lift Arm	2	1-1/8"	1-3/4"	2"	A70-0246B	6.10
Oliver Claw Type Top Link	2	1"	1-3/4"	2"	A 112220	6.53

### LIFT ARM BALL SOCKETS

A = Pin Hole Size  
B = Length Thru Bore  
C = Sleeve Width  
D = Sleeve Outside Diam.

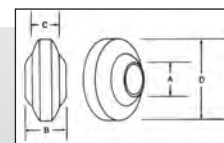

Cat.	A	B	C	D	Order No.	List
1					B05-0216B	6.93
1					B05-0223B	3.33
2	1-1/8"	1-3/4"	1-1/4"	3-1/8"	B05-0200B	16.93

### TOP LINK BALL SOCKETS

A = Pin Hole Size  
B = Length Thru Bore  
C = Sleeve Width  
D = Sleeve Outside Diam.

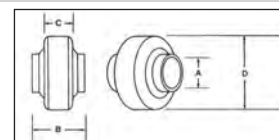

Cat.	A	B	C	D	Order No.	List
2	1"	1-3/4"	7/8"	2-3/8"	B05-0214B	3.48

### LIFT ARM WELD-ON END (\* Bent End)

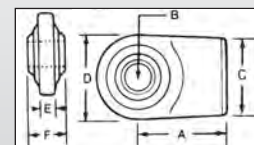

Cat.	A	B	C	D	E	F	Order No.	List
1	2-3/4"	7/8"	2-3/8"	2-5/8"	5/8"	1-3/8"	L35-0160	15.71
2	3-1/8"	1-1/8"	2-3/4"	3-1/8"	3/4"	1-3/4"	L35-0162	22.81

## DRAWBARS

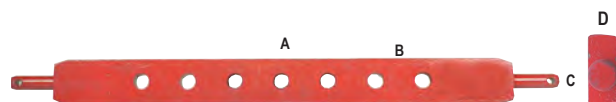

\* Heat Treated

end view

Cat.	Holes	A	B	C	D	E	Order No.	List
1	11	26"	3/4"	7/8"	1"	2-1/2"	A 882837	39.62
2	11	26"	3/4"	1-1/8"	1-1/4"	3"	A 882852	63.75
2	13	32"	3/4"	1-1/8"	1-1/4"	3"	B06-0100*	77.18

## TOP LINK PINS



Pin Cat.	Usable Diam.	Overall Length	Length	Order No.	List
0	5/8"	2-3/4"	4-7/16"	P34-0160	1.25
1	3/4"	3"	4-7/16"	P34-0130	1.60
1	3/4"	4-1/8"	5-7/16"	P34-0135	2.11
1	3/4"	5"	6-7/16"	P34-0145	2.27
2	1"	3-1/8"	4-3/4"	P34-0015	4.86
2	1"	3-13/16"	5-21/64"	P34-0140	4.00
2	1"	4-3/8"	6"	P34-0025	4.16
2	1"	5-1/2"	7-1/4"	P34-0027	4.19
3	1-1/4"	4-3/8"	6-1/2"	P34-0010	8.58

# ACCESSORIES

## AGRICULTURAL HYDRAULIC TIE-ROD CYLINDERS

- Induction-hardened and hard-chrome-plated rods
- O-ring seals throughout with polyurethane back-ups on piston and rods
- High-tensile tie rods - Ductile base and rod clevis mountings
- Rod threaded at full diameter on 1.25" (31.75 mm) rods (clevis end only)
- Cylinder barrels honed to micro-finish
- Ports in line with pin holes on base and rod end clevis
- Double-ported base on 2" (50.8 mm) through 5" (127 mm) cylinders single port on rod end



C95-0005

Bore	Stroke	Retracted Length	Extended Length	Rod Dia.	Port Size	Pin Dia.	Order No.	List
------	--------	------------------	-----------------	----------	-----------	----------	-----------	------

### 2500 PSI CYLINDERS

3"	8"	20-1/4"	28-1/4"	1-1/4"	1/2" NPTF	1"	C95-0010	222.54
----	----	---------	---------	--------	-----------	----	----------	--------

### 3000 PSI CYLINDERS

2-1/2"	8"	20-1/4"	28-1/4"	1-1/4"	9/16"-18 NPTF	1"	C95-0115	169.99
3-1/2"	8"	20-1/4"	28-1/4"	1-1/4"	3/4" - 16 NPTF	1"	C95-0125	229.29

## HERSCHEL HYDRAULIC TIE-ROD CYLINDERS

- Chromed, polished and individually heat-treated shaft provides extended cylinder life.
- All cylinders are 100% hydraulically tested up to two times working pressure.
- Working pressure **2500 psi**.



Bore	Stroke	Retracted Length	Extended Length	Rod Dia.	Port Size	Pin Dia.	Order No.	List
2"	8"	20-1/4"	28-1/4"	1-1/8"	3/8"	1"	C95-2008	142.96
2"	10"						C95-2010	162.05
2-1/2"	8"	20-1/4"	28-1/4"	1-1/8"	3/8"	1"	C95-2508	91.01
3"	8"	20-1/4"	28-1/4"	1-1/4"	1/2"	1"	C95-3008	99.29
3"	10"	20-1/4"	30-1/4"	1-1/4"	1/2"	1"	C95-3010	200.46
3"	16"	31-1/2"	47-1/2"	1-1/2"	1/2"	1-1/4"	C95-3016	244.88
3.5"	8"	20-1/4"	28-1/4"	1-1/4"	1/2"	1"	C95-3508	192.93
4"	8"	20-1/4"	28-1/4"	1-1/4"	1/2"	1"	C95-4008	168.14
4"	16"	31-1/2"	47-1/2"	1-3/4"	1/2"	1"	C95-4016	349.31

## FLUSH-FACE QUICK COUPLINGS FOR SKID STEERS AND ATTACHMENTS

- Pioneer Brand
- USA Made



Order Number	Thread Type	Thread Size	Coupler	Replaces	List
F34-0301	Female O-Ring Boss	7/8-14 UNF	Female	FEM-501-10FO-NL	72.71
F34-0302	Female O-Ring Boss	7/8-14 UNF	Male	FEM-502-10FO	43.58
F34-0303	Female O-Ring Boss	1-1/16-12 UNF	Female	FEM-501-12FO-NL	87.16
F34-0304	Female O-Ring Boss	1-1/16-12 UNF	Male	FEM-502-12FO	46.31
F34-0305	Female Pipe	1/2-14 NPSF	Female	FEM-501-8FP-NL	82.86
F34-0306	Female Pipe	1/2-14 NPSF	Male	FEM-502-8FP	46.36

## DEPTH CONTROL COLLAR KITS

Collars are split with a spring band that clamps collar on shaft. Can be used in any combination to obtain the required depth control. Easy to use, just snap on and off any cylinder. Complete with spring clamps.



Shaft Size	Depth Collars	Order No.	List
1-1/8", 1-1/4"	3/4", 1", 1-1/2"	A 153312	23.21
1-3/4", 1-7/8", 2"	1", 1-1/2", 2", 4"	A 153314	44.36

## BULK HYDRAULIC HOSE

Made In The USA  
Compatible with Parker, Dayco and Gates fittings.  
Not compatible with Weatherhead

- Oil and Weather Resistant
- -40° F TO +212° F Temperature Range

Firescreen II Formerly Farmex II Type at 100R16

- 2 Wire Equivalent



ID	Feet Per Reel	Operating Pressure	Burst Pressure	Order Number	List
3/8"	250 FT.	4000 PSI	16,000 PSI	H58-0802	2.88
1/2"	250 FT.	3500 PSI	14,000 PSI	H58-0804	3.56
3/4"	250 FT.	2250 PSI	9,000 PSI	H58-0806	6.15

Parker Type at 100R2

- 2 High Tensile Wire Braids

ID	Feet Per Reel	Operating Pressure	Burst Pressure	Order Number	List
1/4"	475 FT.	5000 PSI	20,000 PSI	H58-0710	2.67
3/8"	385 FT.	4000 PSI	16,000 PSI	H58-0712	2.92
1/2"	425 FT.	3500 PSI	14,000 PSI	H58-0714	4.12

## HYDRAULIC HOSE ASSEMBLIES



- Male fittings on both ends.
- Neoprene cover is oil and weather resistant.

### PSI Ratings

1/4"	2500 PSI
3/8"	4000 PSI
1/2"	3500 PSI

Length	1/4"		3/8"		1/2"	
	Order No.	List	Order No.	List	Order No.	List
12"	A 1021005	7.07	A 1020502	9.56		
18"	A 1021013	7.41				
24"	A 1021021	9.20	A 523282	10.71		
3'					A 523399	13.33
5'	A 1021062	14.95			A 523415	18.53
6'			A 523324	18.28	H58-0135	20.79
8'					A 523449	25.51
10'					A 523464	54.97
12'					A 523472	52.19
15'					A 1020692	43.00

## HYDRAULIC ADAPTERS



John Deere Old Style

John Deere New Style

Int. Harvester Old Style



JI Case Old Style



JI Case Old Style



Pioneer

Using Male Tip	Using Female Body	Order No.	List
Pioneer ISO	John Deere Old Style	A15-0225	38.51
Pioneer ISO	Int. Harvester Old Style	A15-0230	34.72
John Deere Old Style	JI Case New Style	A15-0238	52.77
John Deere Old Style	Pioneer	A15-0235	43.48
JI Case Old Style	Pioneer	A15-0240	45.96

## SPECIALIZED COUPLERS



### MALE TIPS

Thread Description	Size	Replaces	Order No.	List
John Deere "Old Style"	1/2" NPTF	5060-4	F34-0170	16.04
John Deere "Old Style"	3/4" ORB	5060-15	F34-0175	16.66
Case "Old Style"	1/2" NPTF	5080-4	F34-0188	22.98

## PIONEER COMPLETE COUPLERS

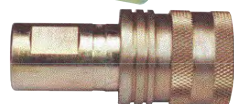

Replaces No.	Body Size	Replaces Male	Thread Size	Replaces Female	Thread Size	Order No.	List
4000-4	1/2"	8010-4	1/2"-14 NPTF	4050-4	1/2"-14NPTF	C59-0025	38.93
4000-15	1/2"	8010-15	3/4"-16 ORB	4050-15	3/4"-16 ORB	C59-0028	45.67
4200-4	1/2"	8010-4	1/2"-14 NPTF	4250-4**	1/2"-14NPTF	C59-0030	39.77
8200-4	1/2"	8010-4	1/2"-14 NPTF	8250-4***	1/2"-14NPTF	C59-0050	58.76

\* Indicates Poppet Style which prevents uncoupled leakage.

\*\* 4200 Series feature double acting sleeve for one handed operation when coupler is clamp or bulkhead mounted.

\*\*\* 8200 Series feature above plus unique valve design that permits connection while either or both coupler and nipple are under pressure.

## PIONEER ISO COUPLERS

### FEMALE BODIES



Body Size	Replaces	Thread Size	Overall Length	Wrench Flats	Largest Diameter	Order No.	List
1/2"	4050-4	1/2"-14 NPTF	2.60"	1.06"	1.52"	F34-0159	26.30
1/2"	4050-4P	1/2"-14 NPTF	2.60"	1.06"	1.52"	F34-0207*	27.22
1/2"	4250-4	1/2"-14 NPTF	2.68"	.94"	1.50"	F34-0165*	26.28
1/2"	4250-4P	1/2"-14 NPTF	2.68"	.94"	1.50"	F34-0208*	31.70

### MALE TIPS



Body Size	Replaces	Thread Size	Overall Length	Exposed Length	Hex Size	Largest Diameter	Order No.	List
3/8"	4010-3	3/8"-18 NPTF	1.60"	.80"	.94"	1.08"	F34-0155	11.23
1/2"	8010-4	1/2"-14 NPTF	1.95"	1.09"	1.06"	1.23"	F34-0195	8.95
1/2"	8010-4P	1/2"-14 NPTF	1.95"	1.09"	1.06"	1.23"	F34-0203*	10.34
1/2"	8010-15	3/4"-16 ORB	2.06"	1.20"	1.06"	1.23"	F34-0196	14.74
1/2"	8010-15P	3/4"-16 ORB	2.06"	1.20"	1.06"	1.23"	F34-0204*	15.58
3/4"	4110-5	3/4"-14 NPTF	1.81"	1.23"	1.31"	1.52"	F34-0163	19.35

\* Indicates Poppet Style

## PILLOW BLOCKS AND FLANGES



Shaft Size	RELUBE TYPE		PRE LUBE TYPE		CAST IRON PILLOW BLOCKS				STAMPED STEEL FLANGES (SOLD AS PAIRS)						CAST FLANGE	
	Order No.	List	Order No.	List	HIGH CENTER		LOW CENTER		2 HOLE		3 HOLE TRIANGLE		3 HOLE ROUND		4 HOLE	
	Order No.	List	Order No.	List	Order No.	List	Order No.	List	Order No.	List	Order No.	List	Order No.	List	Order No.	List
1/2	B15-1010D	6.55	B15-2009D	6.10			B15-5004	4.81			F45-3340	2.31	F45-3040	2.26		
5/8							B15-5004	4.81			F45-3340	2.31	F45-3040	2.26		
3/4			B15-2012D	8.00			B15-5004	4.81	F45-2047	2.31			F45-3047	2.74		
7/8	B15-1014D	6.67	B15-2014D	6.34			B15-5005	6.87							F45-4205	4.93
15/16	B15-1016D	6.67					B15-5005	6.87							F45-4205	4.93
1			B15-2100D	9.60			B15-5005	6.87							F45-4205	4.93
1-1/8									F45-2062	2.79						
1-3/16									F45-2062	2.79						
1-1/4 (LD)									F45-2062	2.79						
1-1/4 (HD)															F45-4207	7.72
1-3/8															F45-4207	7.72
1-7/16															F45-4207	7.72
1-1/2	B15-1108D	12.67			B15-5108	11.20									F45-4208	9.60
1-9/16			B15-2109D	11.62	B15-5108	11.20									F45-4208	9.60
1-7/8			B15-2114D	17.27	B15-5110	16.96										
1-15/16	B15-1115D	17.60			B15-5110	16.96										
2					B15-5110	16.96										
2-1/4																
2-3/8																
2-7/16	B15-1121D	28.30														
2-3/4																

# ACCESSORIES

## ROLLER CHAIN



Our roller chain is made of selected hardened steel with wearing surfaces hardened for maximum chain life. Side plates are heavy to avoid stretch and rollers are held to close tolerance for better fit. Fully interchangeable with same size chain of other manufacturers and will fit all standard sprockets on combines, corn pickers and other farm machines. When ordering chain, the pitch is the distance between roller centers and the width is the distance between the inside edge of the side bar. Before ordering, check size of chain carefully by pitch and width.

### Regular Roller Chain

Type Chain	Pitch	Approx. Width	Rollers Per Ft.	10' Order No.	Per Roll	50' Order No.	Per Roll	Connecting Link Order No.	List	Half Link/Offset Link Order No.	List
35	3/8"	3/16"	32	C30-3080	26.94			L35-0315	0.31	L35-0410	0.60
40	1/2"	5/16"	24	C30-3085	31.92	C30-3115	159.62	L35-0325	0.31	L35-0420	0.60
41	1/2"	1/4"	24	C30-3090	35.92	C30-3116	76.61	L35-0330	0.33	L35-0425	0.62
50	5/8"	3/8"	19	C30-3095	41.90	C30-3120	209.51	L35-0335	0.40	L35-0430	0.80
60	3/4"	1/2"	16	C30-3100	60.86	C30-3125	304.84	L35-0345	0.55	L35-0440	1.00
60H	3/4"	1/2"	16	C30-3150	52.88	C30-3160	264.38	L35-0355	0.60	L35-0445	1.20
80	1"	5/8"	12	C30-3105	97.77	C30-3124	448.94	L35-0360	1.65	L35-0455	2.51
80H	1"	5/8"	12	C30-3155	89.79			L35-0365	1.62	L35-0460	1.93
100	1-1/4"	3/4"	10	C30-3110	188.56			L35-0370	2.59	L35-0465	3.20
<b>Extended Pitch Roller Chain</b>											
2040	1"	5/16"	12	C30-3170	26.94	C30-3185	135.24	L35-0395	0.51	L35-0490	0.91
2050	1-1/4"	3/8"	10	C30-3175	37.91	C30-3190	189.55	L35-0400	0.60	L35-0495	1.31
2060	1-1/2"	1/2"	8	C30-3180	50.88	C30-3195	110.41	L35-0405	0.80	L35-0500	1.51
<b>Double Strand Roller Chain</b>											
40-2	1/2"	5/8"	24	C30-3135	38.91			L35-0328	0.56		
50-2	5/8"	3/4"	19	C30-3140	78.81			L35-0340	0.91		
60-2	3/4"	1"	16	C30-3145	117.72			L35-0350	1.11	L35-0450	1.71

## STEEL LINK CHAIN

All link chain and attachment links are American made. Our link chain is made from hot rolled strip steel and manufactured on specially designed machines which accurately and uniformly fabricate completely assembled chain. The hook of each link is formed so that the link will not become uncoupled too readily, yet when placed in coupling position may be driven apart without injury. All our chain attachments and assemblies are tested for strength and inspected for dimensional accuracy.



Type	Links Per Roll	Roll Length	Order No.	List
#25	133	10'	C30-1006	50.02
#32	104	10'	C30-1010	44.46
#55	74	10'	C30-1040	59.90
#62	73	10'	C30-1046	72.27

## T-BAR CHAIN LINK



Type	Order No.	List
Regular Link	C30-4175	1.40

## ATTACHMENT LINKS



Chain Type	Link Type	Order No.	List
55	A1 Right	L35-0135	1.38
55	A1 Left	L35-0140	1.45
55	HB4	L35-0191	2.74
55	A2 Right	L35-0271	1.86
55	A2 Left	L35-0272	1.86
55	G27 Right	L35-0300	2.37
55	G27 Left	L35-0295	2.37
62	G27 Right	L35-0550	2.53
62	G27 Left	L35-0555	2.53

## SEALED BALL BEARINGS - AEL OR RA SERIES



B15-2010D

- Pre-lubricated
- Spherical
- Eccentric Locking Cam
- Extended Inner Race One Side
- Individually Packaged

Order Number	Replaces Shaft Number	Fafnir Outside Number	Series	Size	Diameter	List
B15-2009D	UEL201-008		40	1/2"	1.5748"	6.10
B15-2012D	AEL204-012	RA012NPPB	47	3/4"	1.8504"	8.00
B15-2014D	AEL205-014	RA014NPPB	52	7/8"	2.0472"	6.34
B15-2100D	AEL205-100	RA100NPPB	52	1"	2.0472"	9.60
B15-2109D	UEL208-025		80	1.5625"	3.1496"	11.62
B15-2114D	UEL210-030		90	1.875"	3.5433"	17.27

## REGREASABLE BALL BEARINGS - UEL OR G SERIES



B15-1012D

- Regreaseable
- Spherical
- Eccentric Locking Cam
- Extended Inner Race One Side
- Individually Packaged

Order Number	Replaces Shaft Number	Fafnir Outside Number	Series	Size	Diameter	List
B15-1010D	AEL202-010		47	5/8"	1.8504"	6.55
B15-1014D	UEL205-014D1	G1014KRRB	52	7/8"	2.0472"	6.67
B15-1016D	AEL205-015		52	.93"	2.0472"	6.67
B15-1108D	UEL208-108D1	G1108KRRB	80	1-1/2"	3.1496"	12.67
B15-1115D	UEL210-115D1	G1115KRRB	90	1-15/16"	3.5433"	17.60
B15-1121D	AEL212-039		110	2.4375"	4.3307"	28.30

## DISC BEARINGS

Disc Bearing Identification Code

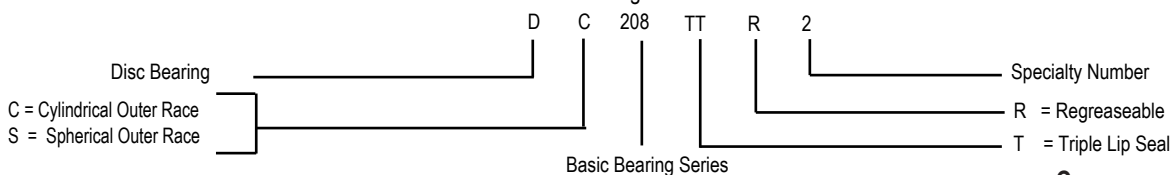

### CYLINDRICAL OUTER RACE - DC SERIES

Bore Number	Outer Number	Outer Race Size (A)	Inner Race Diam. (B)	Width (C)	Width (D)	Order	BCA	List
B15-3180	DC208TT5	1-1/8", SQ	3.1496"	.709	1.438			15.57
B15-3190	DC208TT8	1-1/8", SQ	3.1496"	1.185	1.438			25.58
B15-3184	DC211TT3	1-1/2", SQ	3.397"	1.313	1.313			26.81
B15-3188	DC211TTR3	1-1/2", SQ	3.397"	1.313	1.313			27.25
B15-3182	DC211TT5	1-1/2", SQ	4.000"	1.438	1.750			30.48

### SPHERICAL OUTER RACE - DS SERIES

Bore Number	Outer Number	Outer Race Size (A)	Inner Race Diam. (B)	Width (C)	Width (D)	Order	BCA	List
B15-3176	DS208TT6	1", SQ	3.158"	.709	1.438			25.13
B15-3050	DS208TT5	1-1/8", SQ	3.1496"	.709	1.438			21.02
B15-3110	DS208TT8	1-1/8", SQ	3.1496"	1.188	1.438			27.55
B15-3186	DS208TTR8	1-1/8", SQ	3.150"	1.188	1.438			25.98
B15-3170	DS208TT12	1-1/8", SQ	3.4340"	1.188	1.438			27.34
B15-3144	DS210TTR4	1-1/8", SQ	3.5433	1.188	1.188			31.50
B15-3185	DS209TT5	1-1/4", SQ	3.347"	1.188	1.438			19.69
B15-3080	DS208TT7	1-3/16", RD	3.1496"	.709	1.188			16.92
B15-3120	DS209TT4	1-1/2", RD	3.3465"	1.188	1.188			21.21
B15-3187	DS211TTR3	1-1/2", SQ	3.397"	1.313	1.313			25.00
B15-3150	DS211TT3	1-1/2", SQ	3.9370"	1.313	1.313			26.81
B15-3181	DS211TT6	1-1/2", SQ	4.125"	1.438	1.750			30.48
B15-3130	DS209TTR10	1-3/4", RD	3.3465"	.866	1.438			32.92
B15-3178	DS209TT2	1-3/4", RD	3.347"	1.188	1.188			20.20
B15-3142	DS210TTR2	1-15/16", RD	3.5433"	1.188	1.188			22.45
B15-3177	DS211TTR2	2-3/16", RD	3.937"	1.313	1.313			23.47

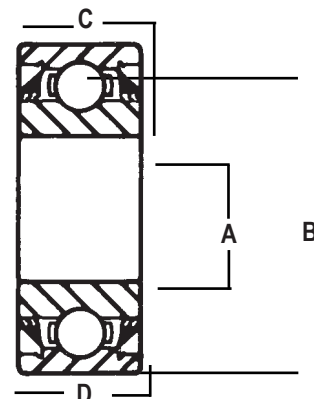

All heavy duty disc bearings feature long lasting triple lip seals.

### RIVETED 4-BOLT FLANGE -- FD SERIES

Order Number	BCA Number	Bore Size	List
B15-3010	FD209RA, ST491A	1-3/4", RD	28.13
B15-3179	FD209RB	1-1/2", RD	34.30

# BALE SPEARS

**BETTER QUALITY. BETTER PRICE.**

- High Tensile Strength Heat Treated Steel
- Standard Duty 2500# 1-3/4" Diameter
- Heavy Duty 3500# 1-3/4" Diameter
- Threaded Spears Include Nut

Assembling Advice For Square Tines

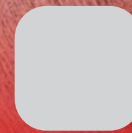

**RIGHT**



**WRONG**

## BOLT ON SPEARS

Nut Included. Order Sleeve Separately.



Description	Length	Capacity	Order No	List
Threaded 36mm diameter	32"	1800 lbs	BS32ONEWN	37.31
Threaded 45mm diameter	32"	2500 lbs	BS32WN	53.32
Threaded 36mm diameter	39"	1800 lbs	BS39ONEWN	59.80
Threaded 45mm diameter	39"	2500 lbs	BS39WN	55.40
Threaded 45mm diameter	43"	2500 lbs	BS43WN	61.26
Threaded 45mm diameter	49"	2500 lbs	BS49WN	73.41
Threaded 45mm diameter	32"	3500 lbs	BS32WNHD	62.10
Threaded 45mm diameter	43"	3500 lbs	BS43WNHD	81.13
Threaded Heavy Duty	49"	3500 lbs	BS49WNHD	92.81

## PIN ON SPEARS

Order Bushing/Sleeve Separately.



Description	Length	Capacity	Order No	List
Cross Bolt Standard Duty	43"	2500 lbs	BS43CB	63.38
Cross Bolt Standard Duty	49"	2500 lbs	BS49CB	76.45

## HARDWARE

Description	Order No	List
Nut. 1.18" diameter	BSNUT	3.10
Sleeve Standard Duty. 4.72" long	BSSLEEVE	12.59
Sleeve Heavy Duty. 5.71" long	BSSLEEVEHD	15.03
Sleeve For Pin On w/1/2" hole. 5.71" long	BSSLEEVECB	13.43
Sleeve For 36mm diameter spears. 4.33" long	BSONESLEEVE	12.07



### BILL TO INFORMATION

Name \_\_\_\_\_  
 Customer Number \_\_\_\_\_  
 Street Address \_\_\_\_\_  
 P.O. Box \_\_\_\_\_  
 City \_\_\_\_\_ State \_\_\_\_\_ Zip \_\_\_\_\_  
 Daytime area code & phone number (\_\_\_\_\_) \_\_\_\_\_  
 E-Mail Address \_\_\_\_\_  
 Customer No. (from back cover) \_\_\_\_\_

### SHIP TO INFORMATION

Name \_\_\_\_\_  
 Street Address \_\_\_\_\_  
 P.O. Box \_\_\_\_\_  
 City \_\_\_\_\_ State \_\_\_\_\_ Zip \_\_\_\_\_  
 Daytime area code & phone number (\_\_\_\_\_) \_\_\_\_\_

Item No.	Quantity	Product Description	(X) if Tax Exempt	Page	Price Each	Total

**METHOD OF PAYMENT**

**Open Account** (Qualified accounts ONLY)      **Visa**  
 **Check or Money Order**                                      **Discover**  
 **American Express**      **MasterCard**

Credit Card Account Number \_\_\_\_\_ / \_\_\_\_\_ / \_\_\_\_\_

Security Code (3 digit code on Back) \_\_\_\_\_     Expiration Date (Month/Year) \_\_\_\_\_

Signature \_\_\_\_\_

**Merchandise Total** \_\_\_\_\_

**Shipping & Handling** \_\_\_\_\_  
(See Inside Back Cover For Details)

**Sub-Total** \_\_\_\_\_

**Sales Tax** \_\_\_\_\_  
Calculate Your Local Sales Tax Here from the Sub-Total Listed Above

**Total Amount** \_\_\_\_\_

# ACCESSORIES

## BILL TO INFORMATION

Name \_\_\_\_\_  
 Customer Number \_\_\_\_\_  
 Street Address \_\_\_\_\_  
 P.O. Box \_\_\_\_\_  
 City \_\_\_\_\_ State \_\_\_\_\_ Zip \_\_\_\_\_  
 Daytime area code & phone number (\_\_\_\_) \_\_\_\_\_  
 E-Mail Address \_\_\_\_\_  
 Customer No. (from back cover) \_\_\_\_\_

## SHIP TO INFORMATION

Name \_\_\_\_\_  
 Street Address \_\_\_\_\_  
 P.O. Box \_\_\_\_\_  
 City \_\_\_\_\_ State \_\_\_\_\_ Zip \_\_\_\_\_  
 Daytime area code & phone number (\_\_\_\_) \_\_\_\_\_

Item No.	Quantity	Product Description	(X) if Tax Exempt	Page	Price Each	Total

**METHOD OF PAYMENT**

Open Account (Qualified accounts ONLY)     Visa  
 Check or Money Order     Discover  
 American Express     MasterCard

Credit Card Account Number \_\_\_\_\_ / \_\_\_\_\_ / \_\_\_\_\_

Security Code \_\_\_\_\_ Expiration Date (Month/Year) \_\_\_\_\_  
(3 digit code on Back)

Signature \_\_\_\_\_

**Merchandise Total** \_\_\_\_\_  
**Shipping & Handling** \_\_\_\_\_  
(See Inside Back Cover For Details)  
**Sub-Total** \_\_\_\_\_  
**Sales Tax** \_\_\_\_\_  
Calculate Your Local Sales Tax Here from the Sub-Total Listed Above  
**Total Amount** \_\_\_\_\_

# POLICIES

## UPS GROUND SHIPPING



HAWAII AND ALASKA  
ZONE B

- All orders are shipped FOB from our nearest warehouse or directly from the manufacturer or supplier.
- Most shipping charges are based on the merchandise total for your order (see chart).
- Some items are subject to additional freight or handling fees.
- Items exceeding standard shipper's weight or size limitations will be shipped pre-paid via freight truck. If liftgate is required additional fees may apply. Ask for details.
- Orders ship within 24 business hours. Valid on in stock merchandise only.
- For faster delivery, request UPS Overnight, 2-Day or 3-Day Delivery from our customer service representative. Additional shipping charges will apply on expedited orders.
- Allow at least seven working days from the time your order is placed for delivery. We cannot be responsible for delays caused by UPS, Parcel Post or other freight companies, however, if you feel there has been an unreasonable delay, please contact us.
- For all orders shipped outside the 48 contiguous states, you will be charged the actual shipping charges. Please remit all orders in US funds. For Canadian Customers - Duty, GST and Brokerage Fees, PST (if applicable) will be collected at delivery. We will assist in figuring your shipping charges. Please call 1-888-828-3276 for assistance.

Order Amount	Zone A	Zone B
0 - 99	\$10.75	\$25.50
100 - 150	\$15.75	\$34.50
151 - 250	\$20.00	\$39.50
251 - 500	FREE	\$51.00
501 - 750	FREE	\$65.00
751 - 1000	FREE	\$80.00
1001 & Up	FREE	\$90.00

## UPS GROUND TRANSIT TIMES - Shipped From Indianola, IA 50125



## METHODS OF PAYMENT

We gladly accept Visa, MasterCard, Discover, American Express. Mail and Fax orders can pay by credit card, check, money order or cashiers check.

## SPECIFICATIONS

- Merchandise prices and specifications are subject to change without notice.
- Prices listed in this catalog do not include freight. Please refer to the chart above for freight charges.
- Typographic, photographic or descriptive errors are subject to correction.

## BACK-ORDERED ITEMS

We make every attempt to have all items in stock. However, in the event an item is back-ordered, it will be shipped as soon as possible.

## SHORTAGES & CLAIMS

Please check merchandise immediately upon receipt and report any error at that time. If a part of the packaging is broken open or in bad condition, please note this on the carriers receipt when signing for it.

## PRODUCT WARRANTIES

### Limited Warranty

Herschel Parts warrants products it manufactures to be free of material defects in workmanship and materials at the time of manufacture. Products sold by Herschel Parts, but produced by manufacturers other than Herschel Parts, are warranted only to the extent of the manufacturer's warranty. The Herschel Parts warranty applies only to products properly installed and operated under normal conditions. This warranty does not cover diagnosis or installation labor. If, in the judgment of Herschel Parts, a product has been altered in any way, misused, improperly installed, or fails to perform satisfactorily due to operator error, this warranty shall be void. Herschel Parts is not liable for damages from or to equipment, damage to any property, personal injury (including death) or economic loss which results from purchase or use of any product sold or provided by Herschel Parts. Herschel Parts will repair or replace, at its option, any defective products as provided below. THIS WARRANTY IS THE ONLY WARRANTY PROVIDED ON THE PRODUCTS. HERSCHEL PARTS DISCLAIMS ANY EXPRESS OR IMPLIED WARRANTIES WITH RESPECT TO THE PRODUCTS INCLUDING, BUT NOT LIMITED TO WARRANTIES OF MERCHANTABILITY AND FITNESS FOR A PARTICULAR PURPOSE.

### TERMS OF COVERAGE:

#### Tillage Parts - 90 days from the date sold to end user

Plow Shares manufactured by Herschel Parts carry a 100% warranty if share measures over 4-1/8" wide behind the first bolt hole, or a 50% warranty if share measures 4" - 4-1/8". Shares worn to less than 4" are not covered under warranty. Hard faced shares operated in rocky conditions as determined by Herschel are not covered under warranty.

#### Cutting Parts - 90 days from the date sold to end user

Sickle failure due to head breakage - Herschel Parts will repair or replace only the head, not the entire sickle.

## RETURNED MERCHANDISE

Please call toll free 1-888-828-3276 for return authorization prior to returning any product to Herschel Parts. Merchandise that is being returned for any reason must be sent prepaid to our Indianola, IA distribution center within 30 days of purchase. Exchange or refund will be made promptly when the returned merchandise is in good condition, unused, in original packaging with proper packing materials and the reason for the return is stated. A 15% restocking charge will be applied to all returns for reasons other than shipping or warranty. **Merchandise returned without return authorization paperwork may be refused.** Merchandise that has been installed is non-refundable. Parts returned due to our error are limited to refund of purchase price plus shipping charges. No returns on special order product.

## ELECTRICAL COMPONENTS AND OPENED GASKET SETS CAN NOT BE RETURNED.

## SALES TAX EXEMPTION

Jurisdiction law requires us to charge the applicable sales tax to our customers that do not have current tax-exempt certificates on file.

Please use the following address to access our Exemption Certificate Portal to create or update a certificate:

<https://alamo-group-ecp.ondemand.vertexinc.com/vertex-ec/ALAMO-GROUP>

### Step One: How To Create a User Account:

- Select "Create New User"
- Select "New Customer" and complete the form. If you know your customer number, please enter it as it appears on your invoices and add zeros at end of your number for a total of ten digits.

Once you create your account, you will be prompted to log back in to complete step two.

### Step Two: Complete/Upload a Certificate

- Log in using the username and password created in step one
- Select "Create"
- Select all states in which you want to submit a certificate
- Choose the type of certificate
  - If a state requires a state issued document - you can upload the image
  - If a state does not require a state issued document - you create a new certificate
- Choose a "Blanket" exemption
- List the types of product you will be purchasing
- Follow remaining prompts
- Complete buyer information - update phone number
- Sign the forms - you may either sign with your mouse or upload a pdf of your signature



**HERSCHEL PARTS**  
Quality Ag Parts Since 1887

1301 N 14TH STREET • INDIANOLA, IA 50125

Customer Number:

Source Code:

**TIGER SHARK™**



**TERMINATOR  
SWEEPS**

**flo-rite**  
seed firmers

Get the  
**Adams Edge.™**

CONNECT WITH US!



Order Online [www.herschelparts.com](http://www.herschelparts.com)  
Toll-Free Customer Service 888-828-3276  
Mail Order/Store 1301 N 14th Street Indianola, IA 50125