

2023

HERSCHEL PARTS™ MASTER CATALOG
Quality Ag Parts Since 1887

HARVESTING | HAY/FORAGE | FARM SUPPLIES | TILLAGE TOOLS



CONNECT WITH US!



WWW.HERSCHELPARTS.COM | 888-828-3276



COMMITTED TO QUALITY, SERVICE AND SELECTION SINCE 1887

Our Agricultural Background

Founded in 1887, by two brothers, Paul E and H. Robert Herschel. R. Herschel Manufacturing quickly became a leader in the sickle section industry.

For 135 years HERSCHEL has been an innovator in the cutting parts industry and introduced the chrome plated section (1950), Tiger Jaw®(1981) and Tiger Jaw 2000®(1997) combine conversion kits, Super 7® sections (1992) and most recently the Tiger Shark™ section (2016). Cutting parts designed to provide the agricultural industry with a high quality product at an exceptional value. We are proud to still make our popular cutting products at our factory in Indianola, IA.

In 1995, Herschel Manufacturing decided to expand their tillage market and made the decision to purchase ADAMS Hard-Facing. Adams Hard-Facing was founded in 1927 by W.E. Adams and was known for long wearing, high quality hard-faced and plain tillage tool parts. The addition of these unique and high quality parts to this product line has enhanced our industry-leading position in tillage. We have proudly continued to make high quality tillage tools like our Terminator Sweeps at our factory in Indianola, IA.

These fine products are available from a SINGLE SOURCE, Herschel Parts! The ultimate in PARTS quality, value, and service!

How To Order From Herschel Parts

Toll-Free Phone: 888-828-3276

Customer Service Reps Are Available Monday - Friday from 8:00 am - 4:30 pm CST.

Online at www.herschelparts.com

Store/Mail Order: 1301 N 14th Street, Indianola IA 50125

CONNECT WITH US!



Order Online www.herschelparts.com
Toll-Free Customer Service 888-828-3276
Mail Order/Store 1301 N 14th Street Indianola, IA 50125

**Why buy anywhere else
when you can buy direct
from the factory?**

**We are the exclusive
distributor of the following:**

TIGER SHARK™



**Get the
Adams Edge™**

**1-Year Guarantee On
Everything We Offer!**

A	
Adapters & Couplers	186 - 187
Aerosols.....	184
Alfalfa Spikes.....	173
Application Charts	
Chisel Sweeps	141
Disc Blades	140
Field Cultivator Sweeps ...	141
Anhydrous Knives.....	177
B	
Baler, Round	
Gathering Wheels	115
Pickup Bands	114
Teeth.....	61, 82, 102
Bale Spears	190
Baler Teeth	110 - 113
Bearings	
Disc.....	155 - 159
Drill Disc.....	179
Gauge Wheel.....	162
Blades	
Coulter	151
Disc.....	152 - 153
Disc Mower	116 - 119
Drill Disc.....	179
Harrow	152 - 153
Peanut.....	171
Rotary Cutter.....	121
Bolts	
#3 Head Plow.....	146
Chrome Plated	146
Clipped Head	146
Elliptical Head	146
Grain Drill.....	179
Section	84
C	
Carb & Choke Cleaner	184
Chains	
Covering.....	178
Roller.....	188
Steel Detachable.....	188
Chisel Plows	
Points	173 - 174
Sweeps	172 - 173
Clamp, Danish Tines	172
Clips, Hammer Lock	146, 169, 170
Closing Wheels.....	162
Combine Conversion Kits	123 - 125
Combine Teeth	123
Coulter Blades	151
Concave.....	151
Fertilizer	151
Fluted/Rippled.....	151
Plain/Flat.....	151
Wavy.....	151
Couplers	187
Covering Chains	178

C CONTINUED	
Cultivator Parts	
Field Cultivator	169
Row Crop	169
S-Tine	172
Cutting Parts	
AGCO-Allis.....	3 - 7
Blackwelder.....	8
Cereal	8
Case-IH.....	9 - 20
Caterpillar.....	21
Field Queen	21
FMC	21
Gehl	22
Hart Carter	23
Hesston.....	24 - 29
Honey Bee	30
JE Love	31
John Deere	32 - 48
Johnson	49
Kosch	50
MacDon.....	51 - 54
Massey.....	55 - 61
New Holland.....	62 - 75
New Idea.....	76 - 77
Owatonna.....	78
Rowse.....	79
Schumacher.....	80
Triumph.....	81
Vermeer	82
White.....	83
Universal.....	84 - 87
D	
Danish Tines.....	172
Disc Assemblies	178 - 179
Disc Blades.....	152 - 153
Cone Style	152
Flat Center	153
Notched.....	152, 153
Plain.....	152, 153
Disc Harrow Bearings.....	155 - 158
Disc Mower Knives	116 - 119
Disc Openers.....	178 - 179
Disc Replacement Parts	159 - 161
Case-IH.....	159
John Deere	160
Sunflower	161
Drawbar	185
Drivelines.....	191
Dust Caps.....	164
F	
Ferobide	176
Fertilizer Tubes.....	179
Furrowers	170

G	
Grain Drill Replacement Parts, JD.	179
Graphite Lubricant	184
Graphite Powder.....	168
Guards	88 - 100
H	
Harrow Tines	177
Hitch Pin	184
Hydraulic Adapters	186
Hydraulic Cylinders.....	186
Hydraulic Hose	186
J	
Jacks	182
L	
Landsides	148
Lift Arm Pins, Hitch	184
Lights	183
M	
Moldboards.....	147
P	
Paint	180 - 181
Planter Parts	
Bearings.....	162
Closing Wheels	162
Disc Openers	178 - 179
Gauge Wheels	162
John Deere Parts ...	163 - 167
Kinze	167
Tires	162
Peanut Blades	171
Pickup Bands.....	114
Plow Shins	147
Plowshares	148 - 149
Points	
Chisel	173 - 174
Drill.....	178
Springtooth.....	173
Subsoiler/Ripper Points ...	175
PTO Drivelines	191
R	
Rake/Baler/Tedder Teeth	101 - 115
Rake Wheels	87
Ripper Points	175
Rotary Cutter Bolts	122
Rotary Cutter Blades	122
Rotary Cutter Drivelines	122
Rotary Cutter Tailwheels	120

Continued On Next Page

MASTER INDEX

S

Seed Boots	179
Seed Tubes	179
Shares, Plow	148 - 149
Shares, Upset Forged	150
Shank Saver	174
Shins	147
Slim Shank Spoons	170
Stem Angles	
Chisel Plows	144 - 145
Field Cultivators	142 - 143
Subsoiler Caps	175
Sweeps	
Chisel	172 - 173
Danish	172
Field Cultivator	169
Hammer-Lock	170
Joyce	171
Row Crop	169
Slim Shank	170
Terminator II	170
V-Plow/Wing	171
Wheatland	172 - 173
Wing	171

T

Talc Powder	168
Technical Information	
Landside	128 - 130
Moldboard	127, 136 - 137
Plowshare	131 - 135
Shins	137 - 138
Tillage	139
Tedder Teeth	108
Tie-Rod Cylinders	186
Tines	
Danish	172
Harrow	177
Tires	162
Toplink Parts	185
Toplinks	185

B	
Bale Counter.....	5
Bearings, Plastic Reel	6
Board, Grass	5
Bolts, Section	5
C	
Clips, Hold Down	5
E	
End Sections	4
G	
Gathering Chain Sprockets	7
Grass Board	5
Guards.....	6
H	
Hammer Rivet Tool.....	7
Hold Down Clips	5
I	
Idler Pulleys	7
P	
Pick-Up Teeth.....	7
Plastic Reel Bearings	7
Plastic Tines	7
Poly Replacement Parts	7
Pulleys, Idler	7

R	
Reel Tines	7
Rivets, Section.....	5
S	
Sections.....	4
Section Bolts.....	5
Section Rivets.....	5
Sickle Assemblies.....	6
Sickle Heads.....	5
Splice Kit.....	5
T	
Teeth, Pick-up	7
Tines, Reel	7
W	
Wear Plate.....	5

HERSCHEL sections are made in the USA from high quality boron steel. Heat-treated for long life. Sections are extra heavy (.116") and chrome unless stated otherwise.

All AGCO-ALLIS sections have 2" hole spacing.

SECTION TYPES

7TS = Super 7® Top Serrated
 SM = Smooth
 US = Under Serrated - 14 Tooth
 TS = Top Serrated - 14 Tooth
 TT = Tiger Tooth
 TJ = Tiger Jaw
 SRK = Tiger Shark™



UNIVERSAL SECTIONS

Fits all AGCO-ALLIS Mowers. Section is 3" x 3-1/16". Uses 9/16 OH rivet. Sold 10 sections per pack.

OEM Number	Application	Design	Order No.	List
70802535	XHSM	H	S20-1142	20.47
70802541	XHUS	A-	S20-5246	17.41
70804709	XHUSCR	A	S20-6344	31.31



SECTION - XHTSCR - H TYPE

Fits AGCO-ALLIS Combines, Floating Bar (soybean) Series 1 & 2. Section is 3" x 2-1/2". Uses 5/8 CS rivet. Sold 10 sections per pack. Replaces OEM 71176531. Bottom countersunk.

Order No.	List
S20-4462	28.28



SECTION - XHTSCR - O TYPE

Fits AGCO-ALLIS Series 3, 300, 400, 500, 700, 800, 7000, 7200, 8000, 8200, 9250, 9255 with Bolt On Sections. Section is 3" x 2-7/8". Sold 10 sections per pack. Top countersunk. Use TJ55 bolt. Replaces 71348175.

Order No.	List
S20-4279	25.27



SECTION - XH7TSCR - O+ TYPE

Fits AGCO-ALLIS 7000, 7200, 8000, 8200, 9250, 9255, MF9250. Fits non-floating platforms & series III with riveted sections. Section is 3" x 2-7/8". Sold 10 sections per pack. Use 9/16 OH rivet. Replaces 71426346.

Order No.	List
S20-4285	24.64



SECTION - XHSRKRK

Fits AGCO-ALLIS Series III to 9255. Section is 3" x 2-7/8". Uses 5/8 CS rivet. Sold 25 sections per pack. Replaces OEM 71135135.

Order No.	List
S20-8279	23.83

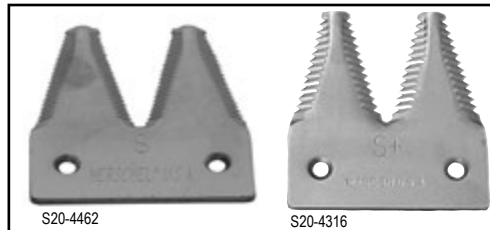

TIGER JAW SECTIONS

Fits all AGCO-ALLIS Combines with Tiger Jaw systems. Section is 3" x 2-1/4". Uses TJ55BN bolt. Sold 10 sections per pack.

Replaces Number	Description	Design	Order No	List
TJ6000	XHTJCR	S	S20-4638	24.64
SSTJ6000	XH7TJCR	S+	S20-4316	27.28

UNIVERSAL END SECTIONS

HERSCHEL "End Sections" are made of one-piece high carbon, heat-treated steel for rugged use. They are punched with an oblong hole to virtually fit any standard cutterbar mower in use today. To install our "End Section", simply take off the last section on the shoe end of your sickle assembly and replace it with an "End Section". The change-over takes only a couple of minutes to complete and you will notice a big difference in time saved from unclogging your mower. We recommend using a R36-0523D oval head rivets or B55-0065D Bolts.

Description	Order No	List	Description	Order No	List
XH7TSCR (RH) 10/Box	S20-4403	59.59	Tiger Shark™ (LH) 2/SP	S20-8445D	18.67
XH7TSCR (RH) 2/SP	S20-4403D	16.31	XHTS CR (RH) 10/Box	S20-4210	59.59
Tiger Shark™ (RH) 10/Box	S20-8403	64.31	XHTS CR (RH) 2/SP	S20-4210D	16.31
Tiger Shark™ (RH) 2/SP	S20-8403D	11.44	XHTSCR (LH) 10/Box	S20-4211	59.59
XH7TSCR (LH) 10/Box	S20-4445	63.81	XHTSCR (LH) 2/SP	S20-4211D	16.31
XH7TSCR (LH) 2/SP	S20-4445D	11.26	XHUSCR (RH) 10/Box	S20-6640	63.12
Tiger Shark™ (LH) 10/Box	S20-8445	64.31	XHUSCR (RH) 2/SP	S20-6640D	16.31



1-YEAR WARRANTY ON ALL ITEMS!

**HOLD DOWN CLIPS
NON-ADJUSTABLE**



Fits all AGCO-ALLIS Mowers, Rigid & Flex, Combine, Except Hart Cart. Steel.

Style	Order No.	List
Low Arch	C45-0692	5.55
High Arch	C45-0693	7.45

SECTION BOLTS

Description	Application	Qty. Pkg	Mstr. Ctn.	Order No	List
Overlap Bolt w/Low Profile Nut, 1/2" CS	Double Drive Sickles (use with Allen Wrench)	10	60	B55-0059D	9.40
Section Bolt, 9/16"CS	Replaces Rivets for Bolt-on Convenience	20	120	B55-0056D	13.52
Head Bolt, 1" CS	Replaces Rivets for Bolt-on Convenience	10	60	B55-0058D	10.68
Section Bolt w/Nut	Universal - Replaces 9/16" & 5/8" Rivets	50	300	B55-0065D	12.28
Head Bolt w/Nut	Universal - Replaces 1" & 1-1/16" OH Rivets	15	90	B55-0085D	7.31
Head Bolt w/Nut	Universal - Replaces 1-1/4" OH Rivets	12	72	B55-0095D	7.51
Section Bolt w/Nut	Universal - Bolts for 10" Sickle w/head bolts (80 -TJ55BN, 5 - TJ85BN, 5-TJ95BN)	90	Each	B55-0500D	28.42
Nut	Universal	20	120	N83-0289D	6.70



SECTION RIVETS - ZINC PLATED

OH = Oval Head CS = Counter Sunk

Size/No. in Pkg.	Application	Qty. Pkg.	Mstr. Ctn.	Order No	List
5/8" # 5-1/2 (56)	7" Heavy Mower Sections and Knife Heads	Asst.	6	R36-0523D	10.70
1" # 5-1/2 (10)					
5/8" # 5-1/2 (72)	Mower Conditioners	Asst.	6	R36-0524D	12.31
1" # 5-1/2 (5)					
1-1/4" # 5-1/2 (5)					
5/8" OH #5-1/2	Heavy Gauge Sections	1#	6#	R36-0462D	16.74
15/16" OH #5-1/2	Head Rivet	1/2#	3#	R36-0522D	9.11
1-1/4" OH #5-1/2	Head Rivet	1/2#	3#	R36-0467D	8.53
5/8" CS #5-1/2	Section Rivet	1#	6#	R36-0463D	13.66
1-1/4" CS #5-1/2	Guard Plate Rivet	1/2#	3#	R36-0468D	8.28



**HOLD DOWN CLIPS
ADJUSTABLE**



Fits all AGCO-ALLIS Mowers & Mower Conditioners. Cast.

Style	Order No.	List
Low Arch	C45-0006	37.80
High Arch	C45-0007	37.80



Fits most AGCO-ALLIS Combines, Mowers & Windrowers, except Hart-Carter & Love. Steel.

Style	Order No.	List
Low Arch	C45-0040	9.05

GRASS BOARD

Fits all mowers.



Order No	List
B52-0615	67.69

BALE COUNTER

Bale counter, reads up to 99,999. 4-hole mounting plate, push button reset, adjustable side arm. Fits most balers.



Order No	List
T55-0002	30.62

SPLICE KIT



For 2" hole spacing on combines, mowers & mower conditioners. Contains 2 straps, bolts & nut.

Order No.	List
C83-0750	26.70

WEAR PLATES



For all AGCO-ALLIS mowers. 6". Replaces W50.

Order No.	List
P44-0591	3.33
P44-0591D*	12.02

*Display Pack of 2.



For all AGCO-ALLIS combines. 6-7/16". Replaces 1116532.

Order No.	List
P44-0472	3.73



For all AGCO-ALLIS combines. 5-1/2" Replaces 1176537.

Order No.	List
P44-0417	3.00

SPLICE BOLT & NUT KIT



For splice segment on all spliced sickles. 12 bolts/nuts per package.

Order No.	List
B55-0049D	11.36

SICKLE HEADS



H15-0194

Fits AGCO-ALLIS Combines, Floating Bar Generation 3, HC & Series 2. For wobble drive. Replaces 71307323.

Order No.	List
H15-0194	138.04



H15-0228

Fits AGCO-ALLIS Combines Series 3 prior to S/N 19301. Replaces 71358960.

Order No.	List
H15-0228	120.24

Our Agricultural Background

Founded in 1887, by two brothers, Paul E and H. Robert Herschel. R. Herschel Manufacturing quickly became a leader in the sickle section industry.

For more than 130 years HERSCHEL has been an innovator in the cutting parts industry and introduced the chrome plated section (1950), Tiger Jaw® (1981) and Tiger Jaw 2000® (1997) combine conversion kits, Super 7® sections (1992) and most recently the Tiger Shark™ section (2016). Cutting parts designed to provide the agricultural industry with a high quality product at an exceptional value. We are proud to still make our popular cutting products at our factory in Indianola, IA.

SECTION TYPES

7TS = Super 7® Top Serrated
 SM = Smooth
 US = Under Serrated
 TS = Top Serrated
 TT = Tiger Tooth
 TJ = Tiger Jaw
 SRK = Tiger Shark™



RIVETED SICKLE - 7 FT

Fits AGCO-ALLIS 7, 80, 80R, 80R3, 80S, 80T, 82R, 82S, 82SH, 82T. Replaces OEM number 70804549.

Head part number is H15-0306, OEM# 70804519.
 Section part number is S20-5246, OEM# 70805241.

# of Sections	Order No	List
28 - XHUS	S35-3716	246.46

BOLTED SICKLES - HEADLESS

Fits AGCO-HART-GLEANER F, L, M, MH, R, R40, R50, R52, R62, R70, R72 ALL WITH SERIES III, FLEX, 300, 500, 700, 800 ALL SERIES I & II RIGID 1986-LATER.

Section part number is S20-4285, OEM# SS71135135.
 Spliced sickle will ship UPS.

A	=	8' Head End S35-2801
B	=	4' Extension S35-2802
C	=	7' Extension S35-2803
D	=	8' Tail End S35-2804

OEM#	Length	# of Sections	A	B	C	D	Order No	List
71348524	24'	95 - XH7TSCR	1	2	0	1	S35-2807	693.58
71348527	27'	107 - XH7TSCR	1	1	1	1	S35-2808	717.99
71348530	30'	119 - XH7TSCR	1	0	2	1	S35-2809	763.50



MALLEABLE GUARD 1 PRONG

Fits AGCO-ALLIS MOWERS 3, 4, 5, 7, 80. Replaces DM700 and 70804072.

Order No.	List
G81-0803	8.24



FORGED GUARD 2 PRONG

Fits AGCO-ALLIS COMBINES, RIGID BAR SERIES A, C, E, R, T, G, F & N. Replaces FC68-2, HA225A, 71116504, 71341601.

Order No.	List
G81-0187	19.25



FORGED GUARD 2 PRONG

Fits AGCO-ALLIS COMBINES, FLOATING BAR. Replaces FC89-2, HA231, 71176532, 71320143.

Order No.	List
G81-0125	22.87



PLASTIC BEARING KIT

Includes 12 bearing halves, 6 bolts, and 6 nuts.

Application: Pipe Reels with Plastic Tines used on AGCO 300, 400, 500, 700, & 800 series.

Order No.	List
B15-0925	31.07

1-YEAR WARRANTY ON ALL ITEMS!

• PATENTED 2 PIECE DESIGN.
• SAVE MONEY!
REPLACE ONLY THE TINE.



HERSCHEL 6" 2-PIECE POLY TINES FOR PIPE REELS

Fits AGCO-ALLIS 700, & 800, 7000 & 8000 series.

Description	Pkg. Qty.	Order No	List
Tine & Clamp	100/Box	T16-0740	233.22
Tine & Clamp	10/Box	T16-0745	25.00
Tine ONLY	100/Box	T16-0750	150.24



COMBINE PICKUP REEL

For Case-New Holland Pickup reels. Replaces H1611. Steel. 100 per box.

Order No.	List
T16-0124	1.90



NYLON FLEX TINE

For Case-New Holland 810 Flex & 820, 1020 1987 & Older. Replaces N66A. 1 mounts to front of bat. 100 per box.

Order No.	List
T16-0183	225.49



NYLON FLEX TINE

For Case-New Holland 1020 1988 & After. Replaces 1970586C1 and N67A. 1 mounts to rear of bat. 100 per box.

Order No.	List
T16-0767	190.20



HAMMER RIVET TOOL

For drive rivets.

Order No	List
T55-0812	30.71



4" - 2 PIECE M/L REEL TINE

Most with pipe reels built up to 2000. Most combines. Replaces 782551. 100 per box.

Order No.	List
T16-0720	251.62



4" - 2 PIECE M/L REEL TINE

Most with pipe reels built up to 2000. Most combines. Replaces 782226. 10 per bag.

Order No.	List
T16-0715	23.22



M/L REEL TINE

For T16-0715 and T16-0720. No clamps. Replaces HA100MLT. 100 per box.

Order No.	List
T16-0725	147.75

Customer Service

Our customer service department has over 105 years of combined experience in the agricultural industry. Each team member prides themselves on providing each customer the highest level of service and strive to ensure that each customers needs are meet beyond their expectations. From your most difficult product questions to placing an order, our Customer Service Representatives are here for you!

Our customer service representatives can be reached Monday - Friday from 8 am to 4:30 PM CST.

Give us a call today!

GATHERING CHAIN ILLDER SPROCKET

Lower idler sprocket, regreasable, 8 tooth, 5/8" hole. For all hugger corn heads. Replaces 71359125.



Order No	List
S62-0726	19.11

1-YEAR WARRANTY ON ALL ITEMS!

BLACKWELDER

HERSCHEL sections are made in the USA from high quality boron steel. Heat-treated for long life. Sections are extra heavy (.116") and chrome unless stated otherwise.

SECTION TYPES

7TS = Super 7® Top Serrated TT = Tiger Tooth
SM = Smooth TJ = Tiger Jaw
US = Under Serrated - 14 Tooth SRK = Tiger Shark™
TS = Top Serrated - 14 Tooth



SECTION - XHSM

Fits BLACKWELDER **Tomato Harvesters**. Bottom countersunk. Section is 3" x 3-1/4". Uses 5/8 OH rivet. Sold 10 sections per pack.

Replaces

Number	Order No	List
49152	S20-1152	25.33

CEREAL (CCIL)



SECTION - XHUS

Fits Cereal **Swathers**. Section is 3" x 3-1/4". Uses 1/2 OH rivet. Sold 10 sections per pack.

Replaces

Number	Order No	List
1145	S20-5107	16.38

B		
Baler Teeth	20	
Bale Counter.....	12	
Bearings, Plastic Reel	19	
Board, Grass	12	
Bolt-N-Clip Kit.....	12	
Bolts, Section.....	12	
C		
Clips, Hold Down	18	
Combine Teeth	19	
D		
Disc Mower Knives	17	
E		
End Sections	11	
G		
Gathering Chain Sprockets	20	
Grass Board	12	
Guards, Case I.H.....	17 - 18	
H		
Hammer Rivet Tool	20	
Head Socket Assemblies.....	16	
Hold Down Clips	18	
K		
Kit, Bolt-N-Clip.....	12	
Kits, Combine Cutterbar Replacement.....	15	
Kits, Spliced.....	16	
O		
Overlap Sections	10	
		P
		Pick-Up Teeth
		19
		Plastic Reel Bearings
		19
		Plastic Tines
		19
		R
		Rake Teeth
		20
		Reel Tines
		19
		Rivets, Section.....
		12
		S
		Sections.....
		10 - 11
		Section Bolts.....
		12
		Section Rivets.....
		12
		Sickle Heads.....
		16
		Sickles
		13 - 15
		Splice Kits/Sickles
		15 - 16
		Spliced Sickles
		15
		Spring Teeth
		20
		Sprockets, Gathering Chain
		20
		T
		Teeth, Combine
		19
		Teeth, Baler
		20
		Teeth, Pick-up.....
		19
		Teeth, Rake
		20
		Teeth, Reel
		19
		Teeth, Spring
		20
		Tines, Reel
		19
		Tooth, Rake
		20
		W
		Wear Plate.....
		19

CASE-IH

HERSCHEL sections are made in the USA from high quality boron steel. Heat-treated for long life. Sections are extra heavy (.116") and chrome unless stated otherwise.

All Case-IH sections have 2-1/16 hole spacing.

SECTION TYPES

7TS = Super 7® Top Serrated	TT = Tiger Tooth
SM = Smooth	TJ = Tiger Jaw
US = Under Serrated - 14 Tooth	SRK = Tiger Shark™
TS = Top Serrated - 14 Tooth	



SECTION - XHTSCR - B TYPE

Fits all CASE mowers and windrowers. Section is 3 x 3-1/4. Uses 1/2 OH rivet. Sold 10 sections per pack. Replaces 049213.

<u>Order No</u>	<u>List</u>
S20-4277	23.83



SECTION - XHTSCR - H TYPE

Fits HART-CARTER Floating Bar (soybean) Series 1 & 2. Section is 3 x 2-1/2. Uses 5/8 CS rivet. Sold 10 sections per pack. Replaces OEM 179736C3. Bottom countersunk.

<u>Order No.</u>	<u>List</u>
S20-4462	28.28



SECTION - XHTSCR

Fits all CASE-IH combines 810 rigid header. Section is 3 x 2-31/32. Uses 9/16 OH rivet. Sold 10 sections per pack. Replaces 634794R2.

<u>Order No</u>	<u>List</u>
S20-4681	27.61

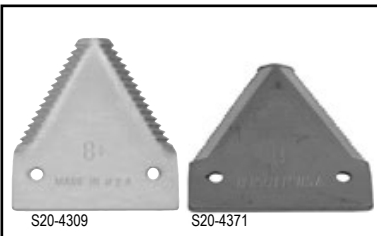

OVERLAP SECTIONS

Fits all CASE-IH double drive sickle overlap. Section is 3 x 3-1/4. Uses 9/16 OH rivet. Sold 10 sections per pack. Replaces TS635161. Bottom countersunk

Description	Design	Order No	List
XH7TSCR	B+	S20-4309	26.82
XHTSCR	B	S20-4371	36.61



HALF SECTION - SMOOTH

One used on head end. Sold 10 sections per pack.

<u>Order No</u>	<u>List</u>
S20-0297	36.74



END SECTION - XHTSCR

Uses 9/16 OH rivet. Sold 10 sections per pack.

Application	OEM #	Order No	List
RH	700705462	S20-4210	59.59
LH	700705463	S20-4211	59.59

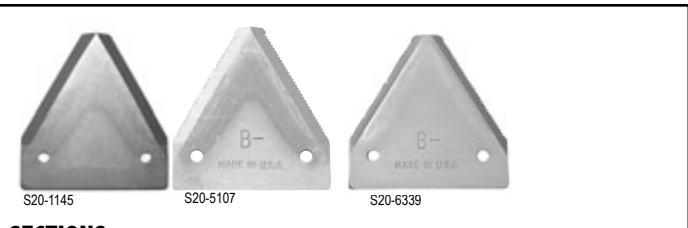

SECTIONS

Fits all CASE-IH mowers, windrowers and mower conditioners. Section is 3 x 3-1/4. Uses 9/16 OH rivet. Sold 10 sections per pack.

OEM #	Description	Design	Order No	List
826724C1	XHSM		S20-1145	19.48
826722C2	XHUS	B-	S20-5107	16.38
457607R3	XHUSCR	B-	S20-6339	20.60

1-YEAR WARRANTY ON ALL ITEMS!



WHY TRY TIGER SHARK™ SECTIONS?

1. Serrated teeth allow more cutting surface.
2. They last longer, cut faster.
3. Cuts equally well in soybeans, alfalfa, grass hay, wheat, etc.

Customer Testimonial:

I cut over 1000 acres of soybeans with the same **Herschel Tiger Shark™** sections. They stayed sharper longer and lasted longer than any section I have used. - Roger Woodruff, Warren Co. Iowa

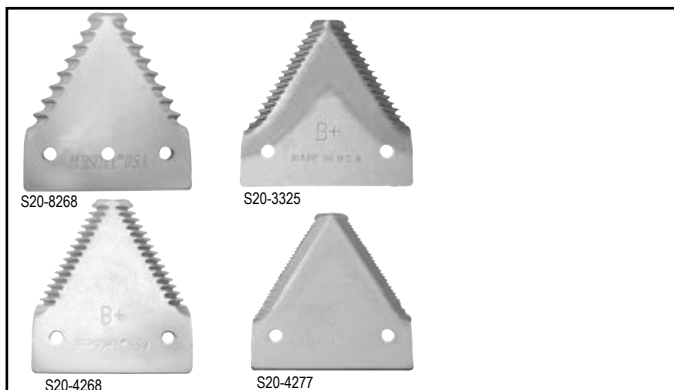

SECTIONS

Fits CASE-IH mowers and conditioners 820, 1010, 1020, 2010, 2020 combine headers. Section is 3 x 3-1/4. Uses 9/16 OH rivet. Sold 10 sections per pack.

The **Tiger Shark™** section can be used in place of the sections listed below.

OEM #	Description	Design	10 Pack		25 Pack	
			Order No	List	Order No	List
	Tiger Shark™	3-Hole	S20-8268	19.51	S20-8268P	41.36
826720C2, 9622744, 86615988	XHTS	B	S20-3276	16.39	S20-3276P	38.95
112074A1, 86616588, 86616691	XH7TS	B+	S20-3325	16.31	S20-3325P	38.90
191256A1, 86616689	XH7TSCR	B+	S20-4268	19.51	S20-4268P	39.98
700705300, 86616527	XHTSCR	B	S20-4277	23.83	S20-4277	56.75
826720C2, 112074A1	XH7TS, 3 hole	B+	S20-3482	22.51		

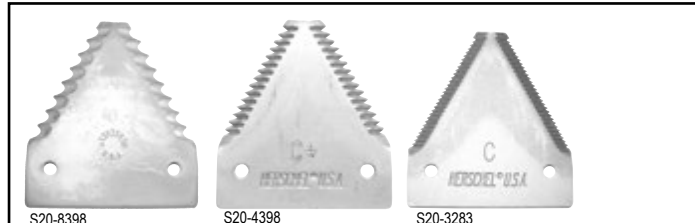

SECTIONS

Fits CASE-IH Combine Heads 1042, 1052, 2042, 2052, 2062, 2142, 2152, 2162. Section is 3 x 3-1/4. Sold 10 sections per pack.

The **Tiger Shark™** section can be used in place of the sections listed below.

OEM #	Description	Design	10 Pack		25 Pack	
			Order No	List	Order No	List
	Tiger Shark™	C+	S20-8398	19.51	S20-8398P	39.98
87422066	XH7TSCR	C+	S20-4398	19.51	S20-4398P	39.98
1327448C1	XHTS	C	S20-3283	20.00	S20-3283P	47.80
84342590	XHTSCR	C	S20-4170	26.18		



SECTIONS

Fits Case-IH 3020, 3152, 3162, NH740CH, NH8800CF Combine Headers. Section is 3 x 3-1/4. Sold 10 sections per pack.

The **Tiger Shark™** section can be used in place of the section listed below.

OEM #	Description	Design	Order No	List
	Tiger Shark™		S20-8549	17.63
87728905	XH7TS	C+	S20-3549	17.63



TIGER JAW SECTIONS

Fits all Case-IH Combines with Tiger Jaw systems. Section is 3 x 3-1/4. Uses B55-0065D bolt. Sold 10 sections per pack.

Replaces		Reference		
Number	Description	Number	Order No	List
TJ7000	XHTJCR	R	S20-4639	27.29
SSTJ7000	XH7TJCR	R+	S20-4317	27.28



IH - 1-1/2" SYSTEM

Fits all Case-IH Combine 1020 with 1-1/2 IH systems. Section is 3 x 3. Uses B55-0050D bolt, B55-0060D Head bolt. Sold 10 sections per pack.

Replaces		
Number	Order No	List
1970390C2	S20-3120	29.76

Our Agricultural Background - Cutting Parts

Founded in 1887, by two brothers, Paul E and H. Robert Herschel. R. Herschel Manufacturing quickly became a leader in the sickle section industry.

For more than 130 years HERSCHEL has been an innovator in the cutting parts industry and introduced the chrome plated section (1950), Tiger Jaw® (1981) and Tiger Jaw 2000® (1997) combine conversion kits, Super 7® sections (1992) and most recently the Tiger Shark™ section (2016). Cutting parts designed to provide the agricultural industry with a high quality product at an exceptional value. We are proud to still make our popular cutting products at our factory in Indianola, IA.

UNIVERSAL END SECTIONS

HERSCHEL End Sections are made of one-piece high carbon, heat-treated steel for rugged use. They are punched with an oblong hole to virtually fit any standard cutterbar mower in use today. To install our End Section, simply take off the last section on the shoe end of your sickle assembly and replace it with an End Section. The change-over takes only a couple of minutes to complete and you will notice a big difference in time saved from unclogging your mower. We recommend using R36-0523D oval head rivets or B55-0065D Bolts.



S20-8445



Description	Order No	List	Description	Order No	List
XH7TSCR (RH) 10/Box	S20-4403	59.59	Tiger Shark™ (LH) 2/SP	S20-8445D	18.67
XH7TSCR (RH) 2/SP	S20-4403D	16.31	XHTS CR (RH) 10/Box	S20-4210	59.59
Tiger Shark™ (RH) 10/Box	S20-8403	64.31	XHTS CR (RH) 2/SP	S20-4210D	16.31
Tiger Shark™ (RH) 2/SP	S20-8403D	11.44	XHTSCR (LH) 10/Box	S20-4211	59.59
XH7TSCR (LH) 10/Box	S20-4445	63.81	XHTSCR (LH) 2/SP	S20-4211D	16.31
XH7TSCR (LH) 2/SP	S20-4445D	11.26	XHUSCR (RH) 10/Box	S20-6640	63.12
Tiger Shark™ (LH) 10/Box	S20-8445	64.31	XHUSCR (RH) 2/SP	S20-6640D	16.31

SECTION BOLTS

- Quick and easy section changes are possible with bolts.
- No more cutting, chiseling, or grinding - simply unbolt the section, replace and tighten bolts.
- Bolts will not turn in Knife Back and are reusable. They will last thru the life of several sections.
- Bolts may be replaced easily if accidentally damaged or broken.
- No special tools are needed to change sections, only a 7/16 wrench or socket.
- Bolt and nuts hold better than rivets and they have a greater clamp load than rivets.
- Special lock nuts will not vibrate loose.

Description	Application	Qty. Pkg.	Mst Ctn.	Order No	List
Section Bolt w/nut	Universal - Replaces 9/16 & 5/8 OH Rivets	50	300	B55-0065D	12.28
Head Bolt w/nut	Universal - Replaces 1-1/2 & 1-1/16 OH Rivets	15	90	B55-0085D	7.31
Head Bolt w/nut	Universal - Replaces 1-1/2 OH Rivets	12	72	B55-0095D	7.51
Head Bolt w/nut	Case I-H Combines 1010 & 1020, 1-1/2 System**. Oval Head. 1-1/8	16	96	B55-0060D	32.33
Head Bolt w/nut	CNH 3152, 3162. M6 X 28MM. Replaces 84429101.	25		B55-4021D	16.42
Head Bolt w/nut	CNH 3152, 3162. M6 X 22MM. Replaces 84429100.	25		B55-4022D	13.22
Head Bolt w/nut	CNH 3152, 3162. M6 X 18MM. Replaces 87663841.	25		B55-4020D	14.93
Section Cone Nut	CNH 3152, 3162. M6. Replaces 84429102.	100		N83-4023D	12.49
Section Bolt w/nut	Universal Bolts for 10' Sickle w/Head Bolts (80-B55-0065D, 5-B55-0085D, 5-B55-0095)	90	Each	B55-0500D	28.42
Overlap Bolt w/Low Profile Nut*	Double Drive Sickles, replaces 1/2 CS rivets 60° Head	10	60	B55-0059D	9.40
Section Bolt*	Versatile, Countersink, replaces 9/16 CS rivets	20	120	B55-0056D	13.52
Section Bolt*	Love & Hart Carter, Countersink, replaces 5/8 CS rivets. 60° Head	20	120	B55-0057D	6.31
Head Bolt*	Love, Hart Carter & Versatile, Countersink, replaces 1 CS rivets	10	6	B55-0058D	10.68
Nut	Universal-Used on all the above bolts except B55-0050D	20	120	N83-0289D	6.70

*Use with Allen Wrench

** Requires IH Hold Down OEM#132074663



OVERLAP SECTION KIT

For Case-IH 8380 and 8840. Contains: (5) S20-4371 - XH TS CR Sections, (3 RH & 2 LH) Btm. CTSK Sections, (10) B55-0059 - CTSK Bolts & Nuts.

Order No **List**
S20-4003 35.83

SECTION RIVETS - ZINC PLATED

OH = Oval Head CS = Counter Sunk

Size/No. in Pkg.	Application	Qty. Pkg.	Mstr. Ctn.	Order No	List
5/8 # 5-1/2 (56)	7' Heavy Mower Sections and Knife Heads	Asst.	6	R36-0523D	10.70
1 # 5-1/2 (10)					
5/8 # 5-1/2 (72)	Mower Conditioners	Asst.	6	R36-0524D	12.31
1 # 5-1/2 (5)					
1-1/4 # 5-1/2 (5)					
5/8 OH #5-1/2	Heavy Gauge Sections	1#	6#	R36-0462D	16.74
15/16 OH #5-1/2	Head Rivet	1/2#	3#	R36-0522D	9.11
1-1/4 OH #5-1/2	Head Rivet	1/2#	3#	R36-0467D	8.53
5/8 CS #5-1/2	Section Rivet	1#	6#	R36-0463D	13.66
1-1/4 CS #5-1/2	Guard Plate Rivet	1/2#	3#	R36-0468D	8.28



SECTION CLIP

For Case-IH 2142, 2152, 2162 Double Drive Head. Fits 42, 52, 62 Series Headers. Replaces 87458207. 20 per pack.

Order No **List**
C45-0050 12.55



BOLT-N-CLIP KIT

Why bolts are better than rivets:

- Bolts will not turn in Knife Back and are reusable.
- They will last thru the life of several sections.
- Bolts may be replaced easily if accidentally damaged or broken.
- No special tools are needed to change sections, only a 7/16 wrench or socket.
- Bolts and nuts hold better than rivets. They have a greater clamp load than rivets.

Fits most mowers, mower conditioners and combines. For 10' bar. Includes 9 Low Arch Clips, 1 High Arch Clip, Bolts & Nuts to do a 10' Bar

Order No **List**
B55-0629 52.17



SECTION CLIP

For CNH 3020, 3152, 3162. Replaces 321848A. 20 per pack.

Order No **List**
C45-0051 14.92

GRASS BOARD

Fits all mowers.



Order No **List**
B52-0615 67.69

BALE COUNTER

Bale counter, reads up to 99,999. 4-hole mounting plate, push button reset, adjustable side arm. Fits most balers.



Order No **List**
T55-0002 30.62

1-YEAR WARRANTY ON ALL ITEMS!

CASE RIVETED SICKLE ASSEMBLIES

MOWER CONDITIONER 555

OEM #	Length	No. Of Sections	Head	Head OEM #	Type	Section	Section OEM #	Riveted Order No	Riveted List	Bolted Order No	List
6566178HD	9'	38	H15-0880	451948HD	XHTSCR	S20-4564	049254	S35-4060	224.96	-	

CASE IH SICKLES

MOWER SERIES 100 BALANCED HEAD 1000 SERIES, 1100, 1300 PIN TYPE

OEM #	Length	No. Of Sections	Head	Head OEM #	Type	Section	Section OEM #	Riveted Order No	Riveted List	Bolted Order No	List
462381R93	7'	28	H15-0281	56692C91	XHSM Tiger Shark™	S20-1145	826724C1 S20-8268	S35-3668	205.43	-	S35-2500 210.68
462380R93	7'	28	H15-0281	56692C91	XHUS	S20-5107	826722C1, 826722C2	S35-3667	159.22	S35-1281	227.39
SS1281292C92	7'	28	H15-0281	56692C91	XH7TS	S20-3325	112074A1	-	-	S35-1032	250.07
1281292C92	7'	28	H15-0281	56692C91	XHTS	S20-3276	826720C2	S35-3939	226.75	-	
1281291C92	9'	35	H15-0281	56692C91	XHTS	S20-3276	826720C2	S35-3940	167.95	S35-1103	215.81
463182R93	9'	35	H15-0281	56692C91	XHSM	S20-1145	826724C1	S35-3672	183.83	-	
463159R93	9'	35	H15-0281	56692C91	XHUS Tiger Shark™	S20-5107 S20-8268	826722C1, 826722C2	S35-3669	169.57	S35-1714 S35-2512	217.07 198.12
SS1281291C92	9'	35	H15-0281	56692C91	XH7TS	S20-3325	112074A1	S35-3012	160.44	S35-1033	189.87

ALL MOWER MODELS EXCEPT SERIES 100 BALANCED HEAD (OLD BALL HEAD)

OEM #	Length	No. Of Sections	Head	Head OEM #	Type	Section	Section OEM #	Riveted Order No	Riveted List	Bolted Order No	List
1958206C1	6'	24	H15-0257	MA999	XHUS	S20-5107	826722C1, 826722C2	S35-3629	163.14	-	
1958205C1	7'	28	H15-0257	MA999	Tiger Shark™	S20-8268	-	-	-	S35-1131	195.28
1958207C1	7'	28	H15-0257	MA999	XHUS	S20-5107	826722C1, 826722C2	S35-3630	163.36	S35-1282	234.57
SS1958207C1	7'	28	H15-0257	MA999	XH7TS	S20-3325	112074A1	S35-3631	177.08	S35-1031	192.50
1958203C1, MB409	7'	28	H15-0257	MA999	XHSM	S20-1145	826724C1	S35-3543	173.76	-	
463294R91	9'	36	H15-0257	MA999	XHUS	S20-5107	826722C1, 826722C2	S35-3304	293.95	-	
1958206C1	6'	24	H15-0257	MA999	XHSM	S20-1145	826724C9	S35-3542	167.58	-	
SS463294R51	9'	36	H15-0257	MA999	XH7TS	S20-3325	112074A1	S35-1097	283.09	-	

MOWER CONDITIONER 990

OEM #	Length	No. Of Sections	Head	Head OEM #	Type	Section	Section OEM #	Riveted Order No	Riveted List	Bolted Order No	List
542816R91, 542816R92	7'	28	H15-0131	540607R11	XHUS	S20-5107	826722C1, 826722C2	S35-3132	219.91	-	
540605R91, 540605R92	9'	36	H15-0131	540607R11	XHUS Tiger Shark™	S20-5107 S20-8268	826722C1, 826722C2	S35-3133	183.95	S35-1715 S35-2559	303.48 290.29

WINDROWERS 75 PULL TYPE

OEM #	Length	No. Of Sections	Head	Head OEM #	Type	Section	Section OEM #	Riveted Order No	Riveted List	Bolted Order No	List
825821C91	21'	84	Headless	-	XHTSCR	S20-4277	596321R3	-	-	S35-2288	469.30

MOWER 1190

OEM #	Length	No. Of Sections	Head	Head OEM #	Type	Section	Section OEM #	Riveted Order No	Riveted List	Bolted Order No	List
101987C95	7'	29	H15-0283	824594C91	XHUS	S20-5107	826722C1, 826722C2	S35-3293	504.13	-	
101988C95	9'	37	H15-0283	824594C91	XHUS Tiger Shark™	S20-5107 S20-8268	826722C1, 826722C2	S35-3292	410.60	S35-1716 S35-2514	445.38 430.95

WINDROWERS 230, 4000, 5000 ALL WITH SINGLE AUGER OR DRAPER HEADER, 210 S/N 3700-LATER

OEM #	Length	No. Of Sections	Head	Head OEM #	Type	Section	Section OEM #	Riveted Order No	Riveted List	Bolted Order No	List
827814C92	14.5'	57	H15-0283	824594C91	XHUSCR	S20-6339	457607R3	S35-4289	656.02	S35-2717	610.21
831607C94	14.5'	57	H15-0283	824594C91	XHTSCR	S20-4277	596321R3	-	-	S35-2295	539.62
827815C92	16.5'	64	H15-0283	824594C91	XHUSCR	S20-6339	457607R3	S35-4290	592.27	-	
1281480C92	16.5'	64	H15-0283	824594C91	XHTSCR	S20-4277	596321R3	-	-	S35-2296	554.96
827816C92	19.5'	76	H15-0283	824594C91	XHUSCR	S20-6339	457607R3	S35-4291	637.43	-	
1281481C92	19.5'	76	H15-0283	824594C91	XHTSCR	S20-4277	596321R3	-	-	S35-2297	592.31

WINDROWERS 4000, 5000, 5500 ALL WITH DUAL AUGER HEADER

OEM #	Length	No. Of Sections	Head	Head OEM #	Type	Section	Section OEM #	Riveted Order No	Riveted List	Bolted Order No	List
827701C92	14'	56	H15-0283	824594C91	XHTSCR	S20-4277	596321R3	-	-	S35-2587	612.89

WINDROWERS 6500, 7000 WITH SINGLE DRIVE AUGER HEADER

OEM #	Length	No. Of Sections	Head	Head OEM #	Type	Section	Section OEM #	Riveted Order No	Riveted List	Bolted Order No	List
33704	18'	71	Headless	-	XH7TSCR	S20-4398	SS34390CR	-	-	S35-2262	464.45
43074, 338616A1	21'	83	Headless	-	XH7TSCR	S20-4398	SS34390CR	-	-	S35-2253	461.04
43076	4'	16	Headless	-	XH7TSCR	S20-4398	SS34390CR	-	-	S35-2254	239.23
										use w/ S35-2253	
43077	9'	36	Headless	-	XH7TSCR	S20-4398	SS34390CR	-	-	S35-2255	345.71
										use w/ S35-2253	

WINDROWERS 8820 SINGLE AUGER HEADER

OEM #	Length	No. Of Sections	Head	Head OEM #	Type	Section	Section OEM #	Riveted Order No	Riveted List	Bolted Order No	List
700709577	7' LH	25	H15-0390	6821078	XHTSCR	S20-4564	700705300	S35-4390	361.68	-	-
700709578	7' RH	25	H15-0301	6821136	XHHTSCR	S20-4564	700705300	S35-4391	361.68	-	-
700709579	8' LH	29	H15-0390	6821078	XHTSCR	S20-4564	700705300	S35-4388	381.66	-	-
700709580	8' RH	29	H15-0301	6821136	XHTSCR	S20-4564	700705300	S35-4389	381.66	-	-

MOWER, MOWER/CONDITIONER 1490, 1590

OEM #	Length	No. Of Sections	Head	Head OEM #	Type	Section	Section OEM #	Riveted Order No	Riveted List	Bolted Order No	List
143806C92, ZA502889	12'	49	H15-0292	ZA502562	XHUSCR	S20-6339	457607R3	-	-	S35-2293	452.16
143807C92, ZA502890	14'	57	H15-0292	ZA502562	XHUSCR	S20-6339	457607R3	-	-	S35-2294	470.24

MOWER/CONDITIONER 8380, 8840, 8870 WITH 625 AUGER HEADER, SC414DLX, SC416DLX

OEM #	Length	No. Of Sections	Head	Head OEM #	Type	Section	Section OEM #	Riveted Order No	Riveted List	Bolted Order No	List
SS700114590	7' LH	28	H15-0063	700114594	XH7TSCR	S20-4268	700705300	-	-	S35-2001	292.16
SS700709581	7' LH	28	Headless	-	XH7TSCR	S20-4268	700705300	-	-	S35-2003	175.14
SS700114591	7' RH	28	H15-0063	700114594	XH7TSCR	S20-4268	700705300	-	-	S35-2002	296.31
SS700709582	7' RH	28	Headless	-	XH7TSCR	S20-4268	700705300	-	-	S35-2004	175.14
700715165	7' LH	28	H15-0063	700114594	XHTSCR	S20-4277	700705300	-	-	S35-2067	369.47
700715166	7' RH	28	H15-0063	700114594	XHTSCR	S20-4277	700705300	-	-	S35-2068	369.47
SS700114592	8' LH	32	H15-0063	700114594	XH7TSCR	S20-4268	700705300	-	-	S35-2014	307.00
					Tiger Shark™	S20-8268				S35-2528	317.63
SS700709585	8' LH	32	Headless	-	XH7TSCR	S20-4268	700705300	-	-	S35-2017	218.96
SS700114593	8' RH	32	H15-0063	700114594	XH7TSCR	S20-4268	700705300	-	-	S35-2015	307.00
					Tiger Shark™	S20-8268				S35-2532	321.04
SS700709586	8' RH	32	Headless	-	XH7TSCR	S20-4268	700705300	-	-	S35-2016	218.96
700715167	8' LH	32	H15-0063	700114594	XHTSCR	S20-4277	700705300	-	-	S35-2069	346.02
700114894	8' LH	32	Headless	-	XHTSCR	S20-4277	700705300	-	-	S35-2111	326.96
700715168	8' RH	32	H15-0063	700114594	XHTSCR	S20-4277	700705300	-	-	S35-2070	346.02
700715168	8' RH	32	Headless	-	XHTSCR	S20-4277	700705300	-	-	S35-2112	326.96
SS700715778	9' LH	36	H15-0063	700114594	XH7TSCR	S20-4268	700705300	-	-	S35-2305	415.56
SS700715778	9' LH	36	Headless	-	XH7TSCR	S20-4268	700705300	-	-	S35-2306	283.33
SS700715779	9' RH	37	H15-0063	700114594	XH7TSCR	S20-4268	700705300	-	-	S35-2309	415.23
700715778	9' LH	36	Headless	-	XHTSCR	S20-4277	700705300	-	-	S35-2308	251.53
700715779	9' RH	37	H15-0063	700114594	XHTSCR	S20-4277	700705300	-	-	S35-2311	499.67
700715779	9' RH	37	Headless	-	XHTSCR	S20-4277	700705300	-	-	S35-2312	255.47

MOWER/CONDITIONER 8380, 8840, 8870 WITH 625 AUGER HEADER

OEM #	Length	No. Of Sections	Head	Head OEM #	Type	Section	Section OEM #	Riveted Order No	Riveted List	Bolted Order No	List
700114590	7' LH	28	H15-0063	700114594	Tiger Shark™	S20-8268		-	-	S35-2517	302.49
700114591	7' RH	28	H15-0063	700114594	Tiger Shark™	S20-8268		-	-	S35-2519	305.88

MOWER/CONDITIONER 8340

OEM #	Length	No. Of Sections	Head	Head OEM #	Type	Section	Section OEM #	Riveted Order No	Riveted List	Bolted Order No	List
700118673	9'	37	H15-0066	700111003	XHTSCR	S20-4277	596321R3	-	-	S35-2071	357.41

MOWER/CONDITIONER 8360, 8370, 8830, SC412, SC414 CENTER PIVOT WITH 425 HEADER

OEM #	Length	No. Of Sections	Head	Head OEM #	Type	Section	Section OEM #	Riveted Order No	Riveted List	Bolted Order No	List
700110730, 700709622	12'	48	H15-0066	700111003	XHTSCR	S20-4277	596321R3	-	-	S35-2072	392.00
700110731, 700709623	14'	56	H15-0066	700111003	XHTSCR	S20-4277	596321R3	-	-	S35-2073	428.45

MOWER/CONDITIONER 8320, 8330, 8350

OEM #	Length	No. Of Sections	Head	Head OEM #	Type	Section	Section OEM #	Riveted Order No	Riveted List	Bolted Order No	List
700709587, 700712775	7'	29	H15-0390	6821078	XHTSCR	S20-4277	596321R3	-	-	S35-2080	445.65
700111430, 700711767	9'	37	H15-0390	6821078	XH7TSCR	S20-4268	SS596321R3	-	-	S35-2081	282.35
700109341, 700709583	12'	48	H15-0390	6821078	XH7TSCR	S20-4268	SS596321R3	-	-	S35-2082	405.08

COMBINE 820 HEADER - 3 CUT

OEM #	Length	No. Of Sections	Head	Head OEM #	Type	Section	Section OEM #	Riveted Order No	Riveted List	Bolted Order No	List
197463C91, 197463C93	15'	58	H15-0640	197230C91	XHTS	S20-3276	826720C2	-		S35-2115	585.69
197466C91, 197466C93	20'	78	H15-0640	197230C91	XHTS	S20-3276	826720C2	-		S35-2117	647.92

ALL MOWERS MA 999 HEADER & BALANCED HEAD, 990, 1190 M/C

OEM #	Length	No. Of Sections	Head	Head OEM #	Type	Section	Section OEM #	Riveted Order No	Riveted List	Bolted Order No	List
			Headless					-		S35-1038	124.53
			Headless					-		S35-1039	146.18

2142, 2152 RIGID DRAPER HEAD

For 30'

OEM #	Length	No. Of Sections	Head	Head OEM #	Type	Section	Section OEM #	Riveted Order No	Riveted List	Bolted Order No	List
124926	16' RH	35	Headless	-	XH7TSCR	S20-4398	SS34390CR			S35-2120	218.96
124923	16' LH	31	Headless	-	XH7TSCR	S20-4398	SS34390CR			S35-2121	218.96

2162 DOUBLE DRIVE GRAIN HEAD

For 30'

OEM #	Length	No. Of Sections	Head	Head OEM #	Type	Section	Section OEM #	Riveted Order No	Riveted List	Bolted Order No	List
	20.5' LH	81	Headless	-	XH7TSCR	S20-4398	SS34390CR			S35-2130	507.31

COMPLETE SPLICED SICKLES - HEADLESS

Fits CNH 3020 AND NEW HOLLAND 740CF SINGLE DRIVE HEADS

Super 7®

Length	OEM #	S35-3091 Head Segment	S35-3092 Middle Segment	S35-3095 25 FT Tail Segment	S35-3096 30 FT Tail Segment	S35-3097 35 FT Tail Segment	Order No	List
25	84585668	1	1	1			S35-3081	655.81
30	84585666	1	2		1		S35-3082	788.02
35	84585664	1	3			1	S35-3083	960.99

Tiger Shark™

Length	OEM #	S35-8091 Head Segment	S35-8092 Middle Segment	S35-8095 25 FT Tail Segment	S35-8096 30 FT Tail Segment	S35-8097 35 FT Tail Segment	Order No	List
25	84585668	1	1	1			S35-8081	674.18
30	84585666	1	2		1		S35-8082	810.38
35	84585664	1	3			1	S35-8083	979.28

COMPONENTS FOR SICKLES LISTED AT LEFT

Also fits 3152, 3162, NH 740C , 840CD, 880CF



C45-0051



S20-8549

Description	OEM	Order No	List
M6X28MM HEAD BOLT/NUT 25/PK	84429101	B55-4021D	16.42
M6X22MM HEAD BOLT/NUT 25/PK	84429100	B55-4022D	13.22
M6X18MM SECT BOLT/NUT 50/PK	87663841	B55-4020D	14.93
M6 SECTION CONE NUT 100/PK	84429102	N83-4023D	12.49
SECTION XH7TSP 10/PK	87728905	S20-3549	17.63
SECTION XHSRKP 10/PK	N/A	S20-8549	17.63
SECTION CLIP 20/PK	321848A1	C45-0051	14.92
SPLICE KIT INCLUDES STRAPS,BOLTS/NUTS		C83-3020	25.74

COMPLETE SPLICED SICKLES - HEADLESS XH7TS SECTIONS

Fits Case-IH 820 HEADER 3 CUT

Section part number is S20-3325, OEM# 112074A1.

OEM #	Length	# of Sections	A	B	C	D	Order No	List
SPL197463C93	15'	58	1	-	2	-	S35-1048	306.78
SPL197466C93	20'	78	1	-	1	1	S35-1046	431.07

- A = 7' Head End S35-1044
- B = 7.25' Head End S35-1043
- C = 7.5' S35-1042
- D = 5' S35-1041

COMPLETE SPLICED SICKLES - HEADLESS XH7TS SECTIONS

Fits Case-IH 1010, 1020 HEADER 3 CUT 999

Section part number is S20-3325, OEM# 112074A1.

OEM #	Length	# of Sections	A	B	C	D	XH7TS Order No	List	Tiger Shark Order No	List	14-Tooth Order No	List
1307283C98	20'	78	-	1	1	1	S35-1052	342.48	S35-2786	446.96		
1307284C98	22.5'	88	-	1	2	-	S35-1051	348.41	S35-2787	396.09		
1307255C98	25'	98	-	1	1	2	S35-1050	518.07	S35-2774	495.56	S35-2770	518.07
1307286C98	30'	118	-	1	3	-	S35-1049	601.77	S35-2775	575.64	S35-2771	601.77

- A = 7' Head End S35-1044
- B = 7.25' Head End S35-1043
- C = 7.5' S35-1042
- D = 5' S35-1041

SPLICED COMBINE SICKLES

Model	Size	Drive	14-Tooth Order No.	List	Tiger Shark™ Order No.	List
CNH 2152, 2162	30	Single	S35-2181	600.60	S35-2879	585.52
	35	Single	S35-2190	659.37	S35-2888	648.44
	40	Single	S35-2191	804.39	S35-2893	772.24
CNH 2152, 2162	30	Double	S35-2194	627.69	S35-2896	638.92
	35	Double	S35-2195	692.02	S35-2897	709.25
	40	Double	S35-2196	833.43	S35-2898	850.29
	45	Double	S35-2197	908.49	S35-2899	937.68



All sickles are made bolted and headless with extra heavy plated sections.

SPLICE KIT

Splice Kit 2-1/16 hole spacing. Kit Contains 2 straps along with the bolts & nuts.

<u>Order No</u>	<u>List</u>
C83-0755	26.70

Bolts & Nuts for C83-0755 Splice Kit. Contains 12 each per package.

<u>Order No</u>	<u>List</u>
B55-0049D	11.36



SICKLE BACK

Fits Case-IH SERIES 100 & 1000 MOWERS W/ PIN STYLE HEAD



Replaces	Size	Order No	List
IH 7	7'	S35-6096	48.55
IH 9	9'	S35-6095	45.69

OUTER SHOE PLATE

Fits all Case-IH MOWERS

<u>Replaces</u>	<u>Order No</u>	<u>List</u>
MA330	P44-0617	No Match!



PITMAN STRAP - FRONT

Fits all Case-IH MOWERS

<u>Replaces</u>	<u>Order No</u>	<u>List</u>
MA1577	S78-0834	89.93



PITMAN STRAP - REAR

Fits all AUTOMATIC PITMANS

<u>Replaces</u>	<u>Order No</u>	<u>List</u>
M1578	S78-0835	95.12



HEAD PIN

Fits Case-IH BALANCE HEAD 100 SERIES MOWERS.

<u>Replaces</u>	<u>Order No</u>	<u>List</u>
458973R	P34-0641B	40.35

BUSHING

Fits Case-IH HEADS WITH OEM#'S 462378R11 & 540607R11, Series 100 balanced head 1100, 1300.

<u>Replaces</u>	<u>Order No</u>	<u>List</u>
458971R1	B82-0367D	10.81

HEAD BEARING & SNAP RINGS

Fits all IH 810 & 820, HC III; Fits H15-0294 Heads, H15-0295 Heads, H15-0194 Heads, H15-0640 Head.

<u>Replaces</u>	<u>Order No</u>	<u>List</u>
KP12A	B15-0659B	36.64

SICKLE HEADS



Fits Case-IH Combines Floating Bars; 810 Header Wobble Drive HC Gen III. Replaces 180859C91.

<u>Order No</u>	<u>List</u>
H15-0194	138.04



Fits Case-IH Mowers All Except Balanced Head series 100. Replaces MA999.

<u>Order No</u>	<u>List</u>
H15-0257	90.27



Fits Case-IH Mowers w/ Balanced Head Series 100. Replaces 462378R11 and 56692C91.

<u>Order No</u>	<u>List</u>
H15-0281	72.35

Fits Case-IH Combine 810 Header Not Floating Bar. Replaces 178466C91.

<u>Order No</u>	<u>List</u>
H15-0294	No Match!

Fits Case-IH Mower/Conditioner and Windrower 1190, 230, 4000 and 5000. Replaces 824594C91 and 824812C91.

<u>Order No</u>	<u>List</u>
H15-0257	90.27

Fits Case-IH 8380 & 8840, Double Drive Replaces 700114594. Fits both RH and LH sickles.

<u>Order No</u>	<u>List</u>
H15-0063	170.84



Fits Case-IH Mower/Cond. 1490, 1590. Replaces ZA502562.

<u>Order No</u>	<u>List</u>
H15-0292	111.84



Fits Case-IH Combine 1010 & 1020 w/3 System or Tiger Jaw Systems. Replaces 1316161C94

<u>Order No</u>	<u>List</u>
H15-0090	179.97

73.67fits Case-IH IH 1020 Silver Tiger.

<u>Order No</u>	<u>List</u>
H15-0432	91.18



Fits Case-IH IH 820 1-1/2 and 3 Cut systems. Tiger Jaw Sickles. Bolted Sickle. Replaces TJ197230C91.

<u>Order No</u>	<u>List</u>
H15-0640	299.59

Fits CNH 2152, 2162. LH. Replaces OEM# 132896.

<u>Order No</u>	<u>List</u>
H15-0075L	139.44

Fits CNH 2152, 2162. RH. Replaces OEM# 132897.

<u>Order No</u>	<u>List</u>
H15-0075R	139.44

**1-YEAR WARRANTY
ON ALL ITEMS!**

DISC MOWER KNIVES - 13 DEGREE TOP BEVEL

Fits Case-IH 306, 307, 308, 3204, 3205, 3206, 3309

Length: 4.72 Degree of Twist: 13 Hole Diameter: .73
Width: 1.86 Thickness: 0.163 Center Of Hole To Back Edge: .78

OEM Number	Style	Shape	Bolt Order No	6 Blades Order No	List	25 Blades Order No	List
ZA526216	5	LH Twisted	B55-0357D	B45-6992D	16.91	B45-6992	63.76
ZA526215	5	RH Twisted	B55-0357D	B45-6993D	16.91	B45-6993	63.76



FORGED STEEL GUARD

Fits Case-IH Combines Floating Bar. Replaces 232155-234006, FC 89-2 and HA231.

Order No	List
G81-0125	22.87



DISC MOWER KNIVES - 13 DEGREE TOP BEVEL

Fits Case-IH 725, 8309, 8312, 8315, 8850, DC515

Length: 4.21 Degree of Twist: 13 Hole Diameter: .72
Width: 1.78 Thickness: 0.169 Center Of Hole To Back Edge: .80

OEM Number	Style	Shape	Bolt Order No	6 Blades Order No	List	25 Blades Order No	List
700712888	4	RH Twisted	B55-0344D	B45-6568D	15.03	B45-6568	59.94
700712889	4	LH Twisted	B55-0344D	B45-6569D	15.03	B45-6569	59.94



FORGED STEEL GUARD

Fits Case-IH 75 Windrowers. Replaces D8420S K84205, FS 73-2, HA235.

Order No	List
G81-0070	19.03



DISC MOWER KNIVES - 13 DEGREE TOP BEVEL

Fits Case-IH 725, 8309, 8312, 8315, 8850, DC515

Length: 4.21 Degree of Twist: 13 Hole Diameter: .73
Width: 1.86 Thickness: 0.175 Center Of Hole To Back Edge: .78

OEM Number	Style	Shape	Bolt Order No	6 Blades Order No	List	25 Blades Order No	List
700711857	5	RH Twisted	B55-0342D	B45-6559D	14.35	B45-6559	57.98
700711858	5	LH Twisted	B55-0342D	B45-6560D	14.35	B45-6560	57.98

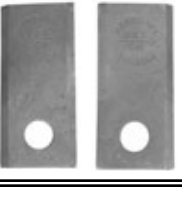

FORGED STEEL GUARD

Fits Case-IH 820, 1010, 1020 Platforms W/ 3 System. (First 3 Guards on LH Drive End). 100 Series Mowers. Replaces 483500R3, 1326787C1, FS 85-2, HA210. No wear bar

Order No	List
G81-0183	14.73



DISC MOWER KNIVES - 18 DEGREE TOP BEVEL

Fits Case-IH 725, 8850, DC515, 8309, 8312, 8315

Length: 4.21 Degree of Twist: 18 Hole Diameter: .73
Width: 1.89 Thickness: 0.157 Center Of Hole To Back Edge: .75

OEM Number	Shape	Bolt Order No	6 Blades Order No	List	25 Blades Order No	List
	LHTwisted	B55-0342D	B45-6725D	17.95	B45-6725	62.31
	RHTwisted	B55-0342D	B45-6726D	17.95	B45-6726	62.31

DISC MOWER KNIVES - 18 DEGREE BOTTOM BEVEL

Fits Case-IH 725, 8850, DC515, 8309, 8312, 8315

Length: 4.21 Degree of Twist: 18 Hole Diameter: .73
Width: 1.88 Thickness: 0.163 Center Of Hole To Back Edge: .78

OEM Number	Shape	Bolt Order No	6 Blades Order No	List	25 Blades Order No	List
700715575, 700715576, 86625673, 86625674	LHTwisted	B55-0342D	B45-6572D	16.74	B45-6572	60.96
	RHTwisted	B55-0342D	B45-6573D	16.74	B45-6573	60.96

DISC MOWER KNIVES - 13 DEGREE TOP BEVEL

Fits Case-IH 3204, 3205, 3206

Length: 4.76 Degree of Twist: 13 Hole Diameter: .89
Width: 1.88 Thickness: 0.165 Center Of Hole To Back Edge: .78

OEM Number	Style	Shape	Bolt Order No	6 Blades Order No	List	25 Blades Order No	List
113385A1	5	RH Twisted	B55-0355D	B45-6563D	16.05	B45-6563	62.90
113384A1	5	LH Twisted	B55-0355D	B45-6564D	16.05	B45-6564	62.90



FORGED STEEL GUARD

Fits Case-IH M/C 8320, 8330, 8340, 8350, 8360, 8370, 8380, SC412, SC414, SC416. Windrowers 525, 625, 8210, 8220, 8230, 8240, 8820, 8830, 8840, DHX182, DHX212, DHX252, DXH362, HDX121, HDX122, HDX141, HDX142, HDX161, HDX162, HDX182, SCX100, SMX91. 2010, 2020 Headers prior to s/nCBJ020000. Replaces 86615982, 700707147, DU215, BU215DH, HA200A, FS97-BH. With cross bar.

Order No	List
G81-0155	15.00
G81-0098 - Double Heat Treat	
G81-0231 - Boron	

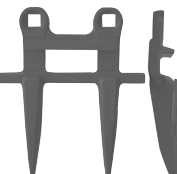

DISC MOWER KNIVES - 18 DEGREE TOP BEVEL

Fits Case-IH 3204, 3205, 3260, 3309

Length: 4.76 Degree of Twist: 18 Hole Diameter: .89
Width: 1.88 Thickness: 0.165 Center Of Hole To Back Edge: .78

OEM Number	Style	Shape	Bolt Order No	6 Blades Order No	List
527749, 113385A1	5	LH Twisted	B55-0355D	B45-6576D	15.50
527748, 113384A1	5	RH Twisted	B55-0355D	B45-6577D	15.50

DISC MOWER KNIVES - 13 DEGREE TOP BEVEL

Fits Case-IH MD72, MD82, MD92, RD132, MDX71, MDX81, MDX91, RD162, DCX91, DCX101, DCS131, DCX161, RDX131, RDX161, RDX181, H7450, H7460, H7550, H7560.

Length: 4.21 Degree of Twist: 13 Hole Diameter: .90
Width: 1.90 Thickness: 0.160 Center Of Hole To Back Edge: .75

OEM Number	Style	Shape	Bolt Order No	6 Blades Order No	List	25 Blades Order No	List
86621873		LH Twisted	N/A	B45-6721D	15.53	B45-6721	60.45
86621872		RH Twisted	N/A	B45-6720D	15.53	B45-6720	62.31

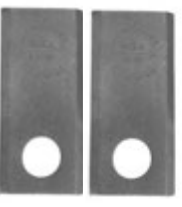

FORGED STEEL GUARD

Fits Case-IH Windrowers 950, 955, 1050, 1055, 1150, 1155, 1275. Replaces 87560324, 87421451. Heat treated. Replaces BU260.

Order No	List
G81-0085	19.61



FORGED STEEL GUARD

Fits Case-IH 1010, 1020, 2010, 2020 Single & Double Drive Heads s/n CBJ020001 and up. Replaces 1307299C2, 87442324, 334305A1, BU299. With wear bar, no cross bar.

Order No. List
G81-0037 17.36



FORGED STEEL GUARD

Fits Case-IH Mower/Cond. & Windrowers. Replaces 049312, FS 86-2, HA250. Stub guard.

Order No. List
G81-0120 13.40



FORGED STEEL GUARD

Fits Case-IH Windrowers. Replaces 823025C1, FT 77-2, HA260. Tie guard

Fits Case Windrowers 950, 955, 1050, 1055, 1150, 1155, 1275. Replaces 049270, FT77-2, BT260, HA260.

Order No. List
G81-0085 19.61



FORGED STEEL GUARD

Fits Case-IH Combines w/Rigid Bars 810. Replaces 633098R1, FC 69-2, HA265.

Order No. List
G81-0055 25.18



FORGED STEEL GUARD

Fits Case-IH Combines w/FLOATING BARS. Replaces 179775C1, FC 89-2, HA231.

Order No. List
G81-0125 22.87



FORGED STEEL GUARD

Fits Case-IH M/C 8320, 8330, 8340, 8350, 8360, 8370, 8380. Windrowers 8210, 8220, 8230, 8240, 8820, 8830. Auger Header 8840. Replaces 1989552C1, 700700845, FS 66-DH, HA245H. Double Heat Treated.

Order No. List
G81-0042 18.96



FORGED STEEL GUARD

Fits Case-IH Mowers 100, 110, 115 & 115. M/C 1190, 1290, 1490 & 1590. Windrowers 75, 210, 230, 275, 375, 4000, 5000 & 5500. Replaces 613838R2, HA270.

Order No. List
G81-0035 17.77



FORGED STEEL GUARD

Fits Case-IH 3020, 3152, 3162. Replaces BU973, 87702973.

Order No. List
G81-0973 19.25



FORGED STEEL GUARD

Fits Case-IH 3020, 3152, 3162. Replaces BU974, 87702974. Head guard. Four used by drive head

Order No. List
G81-0974 19.25



FORGED STEEL GUARD

Fits Case-IH 2040, 2052, 2062, 2142, 2152, 2162 Draper Head. Replaces HA215M, 87421451.

Order No. List
G81-0097 17.43



HOLD DOWN CLIPS NON-ADJUSTABLE



Fits all Case-IH Bolted sickles with head clearance. Steel.

Style	Order No.	List
Low Arch	C45-0692	5.55
High Arch	C45-0693	7.45



Fits all Case-IH Windrowers with guard G81-0120. Steel.

Style	Order No.	List
Low Arch	C45-0502	9.33
High Arch	C45-0503	14.18

HOLD DOWN CLIPS - CASE NON-ADJUSTABLE



Fits CASE Windrowers using guard 049270 (G81-0085). Steel tie plate.

Style	Order No.	List
Low Arch	C45-0500	9.11
High Arch	C45-0501	19.03



Fits all CASE Windrowers using guard 049239 (G81-0040). Steel.

Style	Order No.	List
Low Arch	C45-0692	5.55

HOLD DOWN CLIPS ADJUSTABLE



Fits Case-IH Mowers, Windrowers, & Swathers. Cast.

Style	Order No.	List
Low Arch	C45-0006	37.80
High Arch	C45-0007	37.80



Fits most Case-IH Combines, Mowers & Windrowers, except Versatile, Hart-Carter & Love. Steel.

Style	Order No.	List
Low Arch	C45-0040	9.05

Fits all Case-IH 1020 Series Platforms with 1-1/2 Systems. Top clip ONLY. Steel

Style	Order No.	List
Top Clip	C45-0011	10.71



Fits all Case-IH 1020 Series Platforms with 1-1/2 Systems. Clip kit. Steel

Style	Order No.	List
Low Arch	C45-0012	24.02

MALLEABLE GUARDS

Fits 7/16 Bars.

Replaces	Description	Order No.	List
DM700, T27293	Center Guard	G81-0803	8.24

Fits all Case-IH Mowers.

Replaces	Description	Order No.	List
MC2041Z	Center Guard	G81-0830	14.85

G81-0803



G81-0830

Customer Service

Our customer service department has over 105 years of combined experience in the agricultural industry. Each team member prides themselves on providing each customer the highest level of service and strive to ensure that each customer's needs are met beyond their expectations. From your most difficult product questions to placing an order, our Customer Service Representatives are here for you!

Our customer service representatives can be reached Monday - Friday from 8 am to 4:30 PM CST.

Give us a call today!

WEAR PLATES



For all Case-IH **Mowers, Swathers, Combines**. Replaces W50. 5-7/8 long. Slotted holes with 3 spacing.

Order No.	List
P44-0591	3.33
P44-0591D*	12.02

*Display Pack of 2.



For all Case-IH **Mowers**. 6" full length. Replaces MC468.

Order No.	List
P44-0417	3.00



For all Case-IH **Tiger Jaws**. 24" length with 1-1/2 spacing. Heat treated.

Order No.	List
P44-0200	17.71

**1-YEAR
WARRANTY
ON ALL
ITEMS!**



PLASTIC BEARING KIT

Includes 12 bearing halves, 6 bolts, and 6 nuts.

Application: Pipe Reels with Plastic Tines used on Case-IH **1010, 1020**.

Order No.	List
B15-0925	31.07

- PATENTED 2 PIECE DESIGN.
- SAVE MONEY!
REPLACE ONLY THE TINE.



HERSCHEL 6 2-PIECE POLY TINES FOR PIPE REELS

Fits Case-IH 1020 built after 2001 & 2020 series.

Description	Pkg. Qty.	Order No.	List
Tine & Clamp	100/Box	T16-0740	233.22
Tine & Clamp	10/Box	T16-0745	25.00
Tine ONLY	100/Box	T16-0750	150.24



MADE IN THE USA



COMBINE PICKUP REEL

For Case-IH **Pickup** reels. Replaces H1611. Steel. 100 per box.

Order No.	List
T16-0124	1.90



NYLON FLEX TINE

For Case-IH **810 Flex & 820, 1020 1987 & Older**. Replaces N66A. 1 mounts to front of bat. 100 per box.

Order No.	List
T16-0183	225.49



NYLON FLEX TINE

For Case-IH **1020 1988 & After**. Replaces 1970586C1 and N67A. 1 mounts to rear of bat. 100 per box.

Order No.	List
T16-0767	190.20



2 PIECE M/L REEL TINE

For Case-IH **1020 w/pipe reels built up to 2000. Most combines**. Replaces 782551, 1989438C1, AH136689, AH153175. 100 per box.

Order No.	List
T16-0720	251.62



2 PIECE M/L REEL TINE

For Case-IH **1020 w/pipe reels built up to 2000. Most combines**. Replaces 782226, 1989438C1, AH136689, AH153175. 10 per bag.

Order No.	List
T16-0715	23.22



M/L REEL TINE

For T16-0715 and T16-0720. No clamps. Replaces HA100MLT. 100 per box.

Order No.	List
T16-0725	147.75



SPRING TOOTH

For Case-IH Reel 990, 1190. Replaces 540565R. 100 per box.

<u>Order No.</u>	<u>List</u>
T16-0128	4.58



SPRING TOOTH

For JI CASE Rakes 170, F170, 2000. Replaces R740S.

<u>Order No.</u>	<u>List</u>
T16-0305	4.39



RAKE SPRING TOOTH

For Case-IH Rakes No. 3, 4, 5, 8, 9, 11, 14, 15, 16, 30, 35, 86, 96, 97. Replaces 462978R1, 457374R1. 100 per box.

<u>Order No.</u>	<u>List</u>
T16-0126	2.82



RAKE SPRING TOOTH

For Farmhand Rakes. Replaces L2117RH. 50 per box.

<u>Order No.</u>	<u>List</u>
T16-0368	6.38



**GATHERING CHAIN
ILDER SPROCKET**

For Case-IH 800, 900, 1000 series. Replaces 176283C91.

<u>Order No</u>	<u>List</u>
S62-0741	34.31

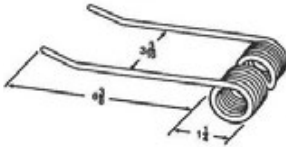

BALER SPRING TOOTH

For Case-IH 4460, 4650, 4900. Replaces 700706128. 25 per box.

<u>Order No.</u>	<u>List</u>
T16-0163	6.23

HAMMER RIVET TOOL

For Drive Rivets

<u>Order No.</u>	<u>List</u>
T55-0812	30.71



HERSCHEL sections are made in the USA from high quality boron steel. Heat-treated for long life. Sections are extra heavy (.116") and chrome unless stated otherwise.

SECTION TYPES

7TS = Super 7[®] Top Serrated TT = Tiger Tooth
 SM = Smooth TJ = Tiger Jaw
 US = Under Serrated - 14 Tooth SRK = Tiger Shark™
 TS = Top Serrated - 14 Tooth



SECTION - XHTS
 Fits CATERPILLAR Lexion Combines. F series platform. Section is 3" x 3.2". 1/4" bolt holes. 2" spacing. Sold 10 sections per pack.

Replaces

Number	Order No	List
149-3303	S20-3478	16.06



SECTION
 Fits CATERPILLAR Lexion Combines. F series platform. Section is 3" x 3.2". 1/4" bolt holes. 2" spacing. Sold 10 sections per pack.

Replaces

Number	Type	Order No	List
149-3303	Tiger Shark™	S20-8517	21.84
149-3303	XH7TS	S20-4517	25.15

FORGED STEEL GUARD
 Fits CATERPILLAR-CLAAS Combines. Double heat treated. Replaces 67629N, HA208H.



Order No List
 G81-0199 14.85

FORGED STEEL GUARD
 Fits CATERPILLAR-CLAAS Combines. Double heat treated. Replaces 67629N, HA208H.



Order No List
 G81-0200 23.47

FORGED STEEL GUARD
 Fits CATERPILLAR-CLAAS, LEXION F20, F25, F30, F525, F530, F535, F540 to s/n 44100862. Double prong guard with crossbar and 3/4" prongs.



Order No List
 G81-0203 14.40

FIELD QUEEN



SECTION - XHUSCR
 Fits FIELD QUEEN Hay Harvester 420, 620. Section is 3" x 3-1/4". Use 9/16 OH Rivet. Sold 10 sections per pack.

Replaces

Number	Order No	List
457607R2	S20-6339	20.60



SECTION - XHTSCR
 Fits FIELD QUEEN Hay Harvester 420, 620. Section is 3" x 3-1/4". Use 1/2 OH Rivet. Sold 10 sections per pack.

Replaces

Number	Order No	List
049213	S20-4277	23.83

HOLD DOWN CLIPS NON-ADJUSTABLE



Fits FIELD QUEEN Hay Harvester 420, 620. Steel.

Style	Order No.	List
Low Arch	C45-0692	5.55

RIVETED SICKLES - HTSCR SECTIONS
 Fits FIELD QUEEN Hay Harvester 420, 620.

Section OEM# 049254. S35-4879
 Head OEM#: 6193577



OEM #	Length	# of Sections	Order No	List
6272959	12'	49	S35-4881	338.42
6272967	14'	57	S35-4879	399.23

HOLD DOWN CLIP ADJUSTABLE



Fits FIELD QUEEN Hay Harvester 420, 620. Stamped

Style	Order No.	List
Low Arch	C45-0040	9.05



C45-0500 C45-0501

Fits FIELD QUEEN Hay Harvester 420, 620. Steel tie plate.

Style	Order No.	List
Low Arch	C45-0500	9.11
High Arch	C45-0501	19.03

FORGED STEEL GUARD
 Fits FIELD QUEEN Windrowers 420, 620. Replaces FS66-2, HA245. Center guard.



Order No List
 G81-0192 13.29

FORGED STEEL GUARD
 Fits FIELD QUEEN Windrowers 420, 620. Replaces 049270, FT-77-2, HA260. Tie guard



Order No List
 G81-0085 19.61

FORGED STEEL GUARD
 Fits FIELD QUEEN Hay Harvesters. Replaces FS65-2.



Order No List
 G81-0035 17.77

FMC TOMATO HARVESTERS



SECTION - XHSM
 Section is 3" x 3-1/4". Use 5/8 CS rivet. Sold 10 sections per pack.

Replaces

Number	Order No	List
5751132	S20-1152	25.33

5' RIVETED SICKLES - XHSM SECTIONS



Section OEM# 5751132.

OEM #	# of Sections	Head OEM	Order No	List
5751487-S	20	Less Head	S35-3064	75.44

HERSCHEL sections are made in the USA from high quality boron steel. Heat-treated for long life. Sections are extra heavy (.116") and chrome unless stated otherwise.

SECTION TYPES

7TS = Super 7[®] Top Serrated TT = Tiger Tooth
 SM = Smooth TJ = Tiger Jaw
 US = Under Serrated - 14 Tooth SRK = Tiger Shark™
 TS = Top Serrated - 14 Tooth



SECTION - XHUSCR
 Fits GEHL Mower Conditioners 770, 880, 1070, 1090. Section is 3" x 3-3/16". Use 5/8" OH rivet. Sold 10 sections per pack. 2-1/16" hole spacing.

Replaces Number	Order No	List
060635	S20-6339	20.60

9' 3" RIVETED SICKLE - XHUSCR SECTIONS HEADLESS
 Fits GEHL Mower Conditioner 880, 1090.

Section OEM# 060635.



OEM #	# of Sections	Order No	List
060969	38	S35-4203	268.67

9' RIVETED SICKLE - XHTSCR SECTIONS
 Fits GEHL Mower Conditioner 2160.

Section OEM# 049254.
 Head OEM# 6582530.



OEM #	# of Sections	Order No	List
6582522	37	S35-4318	232.25

12' RIVETED SICKLE - XHTSCR SECTIONS
 Fits GEHL Mower Conditioner 2230 Swing Frame.

Section OEM# 049254.
 Head OEM# 6193577.

OEM #	# of Sections	Order No	List
6272959	49	S35-4881	338.42

14' RIVETED SICKLE - XHTSCR SECTIONS
 Fits GEHL Mower Conditioner 2262 Swing Frame.

Section OEM# 049254.

OEM #	Description	# of Sections	Head OEM	Order No	List
6832174	LH	28	6821078	S35-4390	361.68
6832224	RH	29	6821136	S35-4391	361.68

UNIVERSAL SICKLES - BOLTED HEADLESS
 Fits GEHL 880, 1090, 2130, 2160



Description	Order No	List
7' XH7TS Knf	S35-1038	124.53
9' XH7TS Knf	S35-1039	146.18

FORGED STEEL GUARD
 Fits GEHL MA206A. Replaces FS65-2, HA270, 044779.



Order No	List
G81-0035	17.77

FORGED STEEL GUARD
 Fits GEHL HK108, HK440, 770, 880, 1070, 1090. Replaces HA250, FS86-2, 049312, 060494.



Order No	List
G81-0120	13.40

FORGED STEEL GUARD
 Fits GEHL 770, 880, 1070, 1090. Replaces HA220, FS82-2, 059827, 072057.



Order No	List
G81-0185	19.25

FORGED STEEL GUARD
 Fits GEHL Mower Conditioner 2230, 2240, 2262 Swing Frame. Replaces FS66-2, HA245, 748178, 611179, 611902. Center guard.



Order No	List
G81-0192	13.29

FORGED STEEL GUARD
 Replaces HA206, BU206, 110-32342.



Order No	List
G81-0140	26.09

MALLEABLE GUARD
 Fits GEHL Mower Conditioner. Replaces MC2041Z, H7540, MA188. Center guard.



Order No	List
G81-0830	14.85

RAKE TEETH
 Fits GEHL Rake Models 207, 208, 216, 217, 218. Replaces 611181. 100/pkg.



Order No	List
T16-0030	4.67

HOLD DOWN CLIPS NON-ADJUSTABLE
 Use with guard G81-0120. Steel.



Style	Order No.	List
Low Arch	C45-0502	9.33
High Arch	C45-0503	14.18

HERSCHEL sections are made in the USA from high quality boron steel. Heat-treated for long life. Sections are extra heavy (.116") and chrome unless stated otherwise.

All HART CARTER sections have 2-1/16" hole spacing.

SECTION TYPES

- | | |
|--------------------------------|--------------------|
| 7TS = Super 7® Top Serrated | TT = Tiger Tooth |
| SM = Smooth | TJ = Tiger Jaw |
| US = Under Serrated - 14 Tooth | SRK = Tiger Shark™ |
| TS = Top Serrated - 14 Tooth | |



SECTION - XHTSCR

Fits HART CARTER Combines, Floating bar. Section is 3" x 2-1/2". Use 5/8 CS Rivet. Sold 10 sections per pack.

Replaces Number	Order No	List
277444	S20-4462	28.28



SICKLE HEAD

Fits HART CARTER Combines, Floating bar, Newest Style Wobble Drive Head Gen III.

Replaces Number	Order No	List
880662	H15-0194	138.04

WHY TRY TIGER SHARK™ SECTIONS?

1. Serrated teeth allow more cutting surface.
2. They last longer, cut faster.
3. Cuts equally well in soybeans, alfalfa, grass hay, wheat, etc.



Customer Testimonial:

"I cut over 1000 acres of soybeans with the same *Herschel Tiger Shark™* sections. They stayed sharper longer and lasted longer than any section I have used." - Roger Woodruff, Warren Co. Iowa

UNIVERSAL END SECTIONS

HERSCHEL "End Sections" are made of one-piece high carbon, heat-treated steel for rugged use. They are punched with an oblong hole to virtually fit any standard cutterbar mower in use today. To install our "End Section", simply take off the last section on the shoe end of your sickle assembly and replace it with an "End Section". The change-over takes only a couple of minutes to complete and you will notice a big difference in time saved from unclogging your mower. We recommend using a R36-0523D oval head rivets or B55-0065D Bolts.



Description	Order No	List	Description	Order No	List
XH7TSCR (RH) 10/Box	S20-4403	59.59	Tiger Shark™ (RH) 2/SP	S20-8445D	18.67
XH7TSCR (RH) 2/SP	S20-4403D	16.31	XHTS CR (RH) 10/Box	S20-4210	59.59
Tiger Shark™ (RH) 10/Box	S20-8403	64.31	XHTS CR (RH) 2/SP	S20-4210D	16.31
Tiger Shark™ (RH) 2/SP	S20-8403D	11.44	XHTSCR (LH) 10/Box	S20-4211	59.59
XH7TSCR (LH) 10/Box	S20-4445	63.81	XHTSCR (LH) 2/SP	S20-4211D	16.31
XH7TSCR (LH) 2/SP	S20-4445D	11.26	XHUSCR (RH) 10/Box	S20-6640	63.12
Tiger Shark™ (LH) 10/Box	S20-8445	64.31	XHUSCR (RH) 2/SP	S20-6640D	16.31



SECTION BOLTS

- Quick and easy section changes are possible with bolts.
- No more cutting, chiseling, or grinding - simply unbolt the section, replace and tighten bolts.
- Bolts will not turn in Knife Back and are reusable. They will last thru the life of several sections.
- Bolts may be replaced easily if accidentally damaged or broken.
- No special tools are needed to change sections, only a 7/16" wrench or socket.
- Bolt and nuts hold better than rivets and they have a greater "clamp load" than rivets.
- Special lock nuts will not vibrate loose.

Description	Pkg.	Qty. Mstr.	Qty. Order No.	List
9/16" CS Section Bolt & Nut	20	120	B55-0056D	13.52
1" CS Head Bolt & Nut	10	60	B55-0058D	10.68



HAMMER RIVET TOOL

For Drive Rivets

Order No.	List
T55-0812	30.71



WEAR PLATE - 6"

Fits Windrowers. Replaces 7382.

Order No.	List
P44-0417	3.00

B	
Baler Teeth.....	29
Bolts, Section	26
C	
Clips, Hold Down	26
D	
Disc Mower Knives.....	29
E	
End Sections	25
G	
Guards.....	26
H	
Hold Down Clips.....	26
O	
Overlap Sections	25
Overlap Section Kits	26
R	
Rake Teeth.....	29
Rivets, Section.....	26
S	
Sections.....	25
Section Bolts.....	26
Section Rivets.....	26
Sickle Assemblies.....	27 - 28
Sickle Heads.....	28
T	
Teeth, Baler.....	29
Teeth, Rake.....	29
W	
Windrower Teeth	29

HERSCHEL sections are made in the USA from high quality boron steel. Heat-treated for long life. Sections are extra heavy (.116") and chrome unless stated otherwise.

All HESSTON sections have 2-1/16" hole spacing.

SECTION TYPES

- | | |
|--------------------------------|--------------------|
| 7TS = Super 7® Top Serrated | TT = Tiger Tooth |
| SM = Smooth | TJ = Tiger Jaw |
| US = Under Serrated - 14 Tooth | SRK = Tiger Shark™ |
| TS = Top Serrated - 14 Tooth | |



S20-6339

SECTIONS

Fits HESSTON Mowers. Section is 3" x 3-1/4". Sold 10 sections per pack.

OEM#	Description	Design	Rivet Used	Order No	List
048009	XHUSCR	B-	1/2 OH	S20-6339	20.60

Our Agricultural Background - Cutting Parts

Founded in 1887, by two brothers, Paul E and H. Robert Herschel. R. Herschel Manufacturing quickly became a leader in the sickle section industry.

For more than 130 years HERSCHEL has been an innovator in the cutting parts industry and introduced the chrome plated section (1950), Tiger Jaw® (1981) and Tiger Jaw 2000® (1997) combine conversion kits, Super 7® sections (1992) and most recently the Tiger Shark™ section (2016). Cutting parts designed to provide the agricultural industry with a high quality product at an exceptional value. We are proud to still make our popular cutting products at our factory in Indianola, IA.

WHY TRY TIGER SHARK™ SECTIONS?

1. Serrated teeth allow more cutting surface.
2. They last longer, cut faster.
3. Cuts equally well in soybeans, alfalfa, grass hay, wheat, etc.



Customer Testimonial:

"I cut over 1000 acres of soybeans with the same *Herschel Tiger Shark™* sections. They stayed sharper longer and lasted longer than any section I have used." - Roger Woodruff, Warren Co. Iowa

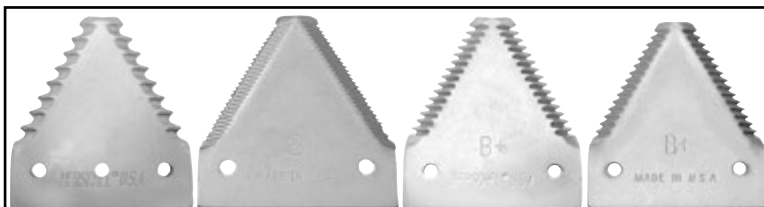

S20-8268

S20-4277

S20-4268

S20-3325

SECTIONS

Fits HESSTON Windrowers and Mower Conditioners. Section is 3" x 3-1/4". Uses a 5/8" OH Rivet. Sold 10 sections per pack.

The *Tiger Shark™* section can be used in place of the sections listed below.

OEM#	Description	Order No	List
	Tiger Shark™	S20-8268	19.51
700705300	XHTSCR	S20-4277	23.83
700705300	XH7TSCR	S20-4268	19.51
700705299	XH7TS	S20-3325	16.31



S20-4464

S20-4317

TIGER TOOTH SECTIONS

Fits all HESSTON Mower Conditioners & Windrowers. Section is 3" x 3-1/4". Uses B55-0065D bolt. Sold 10 sections per pack.

OEM#	Description	Design	Order No	List
TT049254	XHTTCR	R	S20-4639	27.29
SSTJ7000	XH7TTCR	R+	S20-4317	27.28

UNIVERSAL END SECTIONS

HERSCHEL "End Sections" are made of one-piece high carbon, heat-treated steel for rugged use. They are punched with an oblong hole to virtually fit any standard cutterbar mower in use today. To install our "End Section", simply take off the last section on the shoe end of your sickle assembly and replace it with an "End Section". The change-over takes only a couple of minutes to complete and you will notice a big difference in time saved from unclogging your mower. We recommend using an R36-0523D oval head rivets or B55-0065D Bolts.



S20-4210

S20-6640

Description	Order No	List	Description	Order No	List
XH7TSCR (RH) 10/Box	S20-4403	59.59	Tiger Shark™ (LH) 2/SP	S20-8445D	18.67
XH7TSCR (RH) 2/SP	S20-4403D	16.31	XHTS CR (RH) 10/Box	S20-4210	59.59
Tiger Shark™ (RH) 10/Box	S20-8403	64.31	XHTS CR (RH) 2/SP	S20-4210D	16.31
Tiger Shark™ (RH) 2/SP	S20-8403D	11.44	XHTSCR (LH) 10/Box	S20-4211	59.59
XH7TSCR (LH) 10/Box	S20-4445	63.81	XHTSCR (LH) 2/SP	S20-4211D	16.31
XH7TSCR (LH) 2/SP	S20-4445D	11.26	XHUSCR (RH) 10/Box	S20-6640	63.12
Tiger Shark™ (LH) 10/Box	S20-8445	64.31	XHUSCR (RH) 2/SP	S20-6640D	16.31

S20-8445

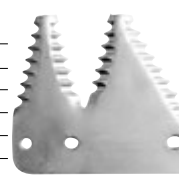

OVERLAP SECTION - XHTSCR - B TYPE

Fits HESSTON Mower Conditioner overlap. Use 3 on right hand and 2 on left hand. Section is 3" x 3-1/4". Sold 10 sections per pack. Replaces OEM# TS635161.

Order No	List
S20-4371	36.61



OVERLAP SECTION - XH7TSCR - B+ TYPE

Fits HESSTON 1170 & 8400 Windrowers. Section is 3" x 3-1/4". Uses bottom CS rivet. Sold 10 sections per pack. Replaces OEM# SST635161

Order No	List
S20-4309	26.82



OVERLAP SECTION KIT - 14 TOOTH

Fits HESSTON 1170, 8840, 666, 6665 Headers. Kit contains 5 of S20-4371, (3 right hand and 2 left hand sections), 10 bolts/nuts (B55-0059 countersunk).

Order No **List**
S20-4003 35.83

OVERLAP SECTION KIT - 14 TOOTH

Fits HESSTON 1014+2, 6450, 6455, 6556, 6855, 6866, 6650, 6655, 6660, 6665, 8100 Auger. Kit contains 5 sections, 1 wear bar and 11 bolts.

Order No **List**
S20-4007 29.38

1-YEAR WARRANTY ON ALL ITEMS!

SECTION BOLTS

- Quick and easy section changes are possible with bolts.
- No more cutting, chiseling, or grinding - simply unbolt the section, replace and tighten bolts.
- Bolts will not turn in Knife Back and are reusable. They will last thru the life of several sections.
- Bolts may be replaced easily if accidentally damaged or broken.
- No special tools are needed to change sections, only a 7/16 wrench or socket.
- Bolt and nuts hold better than rivets and they have a greater clamp load than rivets.
- Special lock nuts will not vibrate loose.

Description	Application	Qty. Pkg.	Mst Ctn.	Order No	List
Section Bolt w/nut	Universal - Replaces 9/16 & 5/8 OH Rivets	50	300	B55-0065D	12.28
Head Bolt w/nut	Universal - Replaces 1-1/2 & 1-1/16 OH Rivets	15	90	B55-0085D	7.31
Head Bolt w/nut	Universal - Replaces 1-1/2 OH Rivets	12	72	B55-0095D	7.51
Section Bolt w/nut	Universal Bolts for 10' Sickle w/Head Bolts (80-B55-0065D, 5-B55-0085D, 5-B55-0095)	90	Each	B55-0500D	28.42
Overlap Bolt w/Low Profile Nut*	Double Drive Sickles, replaces 1/2 CS rivets 60° Head	10	60	B55-0059D	9.40
Nut	Universal-Used on all the above bolts except B55-0050D	20	120	N83-0289D	6.70
Low Profile Nut	Overlap Sickles, use B55-0059D	20	120	N83-0295D	6.90



SECTION RIVETS - ZINC PLATED

OH = Oval Head CS = Counter Sunk

Size/No. in Pkg.	Application	Qty. Pkg.	Mstr. Ctn.	Order No	List
5/8" # 5-1/2 (56)	7' Heavy Mower Sections and Knife Heads	Asst.	6	R36-0523D	10.70
1" # 5-1/2 (10)	Mower Conditioners	Asst.	6	R36-0524D	12.31
5/8" # 5-1/2 (72)	1" # 5-1/2 (5)				
1-1/4" # 5-1/2 (5)					
5/8" OH #5-1/2	Heavy Gauge Sections	1#	6#	R36-0462D	16.74
15/16" OH #5-1/2	Head Rivet	1/2#	3#	R36-0522D	9.11
1-1/4" OH #5-1/2	Head Rivet	1/2#	3#	R36-0467D	8.53
5/8" CS #5-1/2	Section Rivet	1#	6#	R36-0463D	13.66
1-1/4" CS #5-1/2	Guard Plate Rivet	1/2#	3#	R36-0468D	8.28



HOLD DOWN CLIPS

NON-ADJUSTABLE



Fits all HESSTON Mower Conditioners and Windrowers. Steel.

Style	Order No.	List
Low Arch	C45-0692	5.55
High Arch	C45-0693	7.45

FORGED STEEL GUARD

Fits all HESSTON Mower/Cond. & Windrowers. Replaces 049312, FS 86-2, BU250 AND HA250. Stub guard.

Order No **List**
G81-0120 13.40



HOLD DOWN CLIPS ADJUSTABLE

Fits all HESSTON Mowers, Windrowers & Swathers. Cast.

Style	Order No.	List
Low Arch	C45-0006	37.80
High Arch	C45-0007	37.80



Fits all HESSTON Windrowers and Mower Conditioners. Steel.

Style	Order No.	List
Low Arch	C45-0040	9.05



4.79its all HESSTON Mower Conditioners and Windrowers with stub guard G81-0120. Steel.

Style	Order No.	List
Low Arch	C45-0502	9.33
High Arch	C45-0503	14.18



Fits HESSTON Windrowers using guard 049270 (G81-0085). Steel tie plate.

Style	Order No.	List
Low Arch	C45-0500	9.11
High Arch	C45-0501	19.03

FORGED STEEL GUARD

Fits all HESSTON Windrowers. Replaces 049270, FT-77-2, HA260. Tie guard

Order No **List**
G81-0085 19.61



FORGED STEEL GUARD

Fits all HESSTON Super Guard, Mower Conditioners and Windrowers. Replaces 700700845, FS 66-DH, BU245H, HA245H. Double Heat Treated.

Order No **List**
G81-0042 18.96



MOWER CONDITIONERS PT-7, PT-10, 1010

OEM #	Length	No. Of Sections	Head	Head OEM #	Type	Section	Section OEM #	Riveted Order No	Riveted List	Bolted Order No	List
6193510 HD	7'	30	H15-0880	451948 HD	XHTSCR	S20-4013	049213	S35-4593	173.82	-	-

MOWER CONDITIONERS PT-12

OEM #	Length	No. Of Sections	Head	Head OEM #	Type	Section	Section OEM #	Riveted Order No	Riveted List	Bolted Order No	List
429498	12'	49	-	433102	XHTSCR	S20-4013	049213	S35-4325	255.73	-	-

MOWER CONDITIONERS 1070, 1071, 1085, 1090, 1091, 1095

OEM #	Length	No. Of Sections	Head	Head OEM #	Type	Section	Section OEM #	Riveted Order No	Riveted List	Bolted Order No	List
6584031, 70071198	7'	28	-	-	XHTSCR	S20-4564	049254	S35-4317	192.89	-	-

MOWER CONDITIONERS 1070, 1071, 1085, 1090, 1091, 1096

OEM #	Length	No. Of Sections	Head	Head OEM #	Type	Section	Section OEM #	Riveted Order No	Riveted List	Bolted Order No	List
6582522, 700711979	9'	37	-	-	XHTSCR	S20-4564	049254	S35-4318	232.25	-	-

MOWER CONDITIONERS 1070, 1071, 1085, 1090, 1091, 1097

OEM #	Length	No. Of Sections	Head	Head OEM #	Type	Section	Section OEM #	Riveted Order No	Riveted List	Bolted Order No	List
SS6582522	9'	37	-	-	XHTSCR	S20-4268	SS700705300	-	-	S35-2728	317.84

WINDROWERS 200, 220, 240, 260, 280, 300, 500

OEM #	Length	No. Of Sections	Head	Head OEM #	Type	Section	Section OEM #	Riveted Order No	Riveted List	Bolted Order No	List
373530 S	14'	57	-	-	XHTSCR	S20-4013	049213	-	-	S35-2291	357.21
373530 HS	14'	57	-	-	XHTSCR	S20-4564	049254	S35-4452	299.58	-	-

WINDROWERS 520, 620, 1014 HYDRO-SWING, 6200, 6400, 6465, 6550, 6600, 6610 11 HOLE HEAD

OEM #	Length	No. Of Sections	Head	Head OEM #	Type	Section	Section OEM #	Riveted Order No	Riveted List	Bolted Order No	List
6272959	12'	49	-	6193577	XHTSCR	S20-4564	049254	S35-4881	338.42	-	-
SSTT6497101	12'	50	-	TT6497416	XH7TJCR	S20-4317	SSTJ7000	-	-	S35-2375	402.96
6272967	14'	57	-	6193577	XHTSCR	S20-4564	049254	S35-4879	399.23	-	-

WINDROWERS 520, 620, 1014 HYDRO-SWING, 6200, 6400, 6450, 6550, 6600, 6610 21 HOLE HEAD

OEM #	Length	No. Of Sections	Head	Head OEM #	Type	Section	Section OEM #	Riveted Order No	Riveted List	Bolted Order No	List
6497101	12'	49	-	-	XHTSCR	S20-4564	049254	-	-	S35-2101	399.18
SSTT6497101	12'	50	-	-	XH7TJCR	S20-4317	SSTJ7000	-	-	S35-2375	402.96
SS6497119	14'	57	-	-	XH7TSCR	S20-4268	SS700705300	-	-	S35-2730	434.56
6497374	16'	65	-	-	XHTSCR	S20-4564	049254	-	-	S35-2731	478.37
700705843											
6206031	14'	57	Headless	-	XHTSCR	S20-4013	049213	-	-	S35-2291	357.21
6497465	14'	57	Headless	-	XHTSCR	S20-4564	049254	S35-4452	299.58	-	-

WINDROWERS 1014+2 HYDRO SWING, 6450, 6455, 6550, 6555, 6566, 6650, 6655, 6660, 6665, 8100 AUGER HEADER, 21' DRAPER HEADER

OEM #	Length	No. Of Sections	Head	Head OEM #	Type	Section	Section OEM #	Riveted Order No	Riveted List	Bolted Order No	List
6832174	7' LH	25	H15-0390	6821078	XHTSCR	S20-4564	049254	S35-4390	361.68	-	-
SS6832174	7' LH	25	H15-0390	6821078	XH7TSCR	S20-4268	SS700705300	-	-	S35-2285	293.88
6832224	7' RH	25	H15-0301	6821136	XHTSCR	S20-4564	049254	S35-4391	361.68	-	-
SS6832224	7' RH	25	H15-0301	6821136	XH7TSCR	S20-4268	SS700705300	-	-	S35-2286	293.71
6832182	8' LH	29	H15-0390	6821078	XHTSCR	S20-4564	049254	S35-4388	381.66	-	-
SS6832182	8' LH	29	H15-0390	6821078	XH7TSCR	S20-4268	SS700705300	-	-	S35-2325	361.32
6832232	8' RH	29	H15-0301	6821136	XHTSCR	S20-4564	049254	S35-4389	381.66	-	-
SS6832232	8' RH	29	H15-0301	6821136	XH7TSCR	S20-4268	SS700705300	-	-	S35-2326	361.32

MOWER CONDITIONERS 1170, 1270, 1275; WINDROWERS 8020, 8400, 8450, 8600 WITH 625 AUGER HEADERS

OEM #	Length	No. Of Sections	Head	Head OEM #	Type	Section	Section OEM #	Riveted Order No	Riveted List	Bolted Order No	List
SS700114590	7' LH	28	H15-0063	700114594	XH7TSCR	S20-4268	SS700705300	-		S35-2001	292.16
SS700709581	7' LH	28	Headless	-	XH7TSCR	S20-4268	SS700705300	-		S35-2003	175.14
SS700114591	7' RH	28	H15-0063	700114594	XH7TSCR	S20-4268	SS700705300	-		S35-2002	296.31
SS700709582	7' RH	28	Headless	-	XH7TSCR	S20-4268	SS700705300	-		S35-2004	175.14
700114590	7' LH	28	H15-0063	700114594	Tiger Shark™	S20-8268		-		S35-2517	302.49
700114591	7' RH	28	H15-0063	700114594	Tiger Shark™	S20-8268		-		S35-2519	305.88
700715165	7' LH	28	H15-0063	700114594	XHTSCR	S20-4277	700705300	-		S35-2067	369.47
700715166	7' RH	28	H15-0063	700114594	XHTSCR	S20-4277	700705300	-		S35-2068	369.47
SS700114592	8' LH	32	H15-0063	700114594	XH7TSCR	S20-4268	SS700705300	-		S35-2014	307.00
					Tiger Shark™	S20-8268		-		S35-2528	317.63
SS700709585	8' LH	32	Headless	-	XH7TSCR	S20-4268	SS700705300	-		S35-2017	218.96
SS700114593	8' RH	32	H15-0063	700114594	XH7TSCR	S20-4268	SS700705300	-		S35-2015	307.00
					Tiger Shark™	S20-8268		-		S35-2532	321.04
SS700709586	8' RH	32	Headless	-	XH7TSCR	S20-4268	SS700705300	-		S35-2016	218.96
700715167	8' LH	32	H15-0063	700114594	XHTSCR	S20-4277	700705300	-		S35-2069	346.02
700114894	8' LH	32	Headless	-	XHTSCR	S20-4277	700705300	-		S35-2111	326.96
700715168	8' RH	32	H15-0063	700114594	XHTSCR	S20-4277	700705300	-		S35-2070	346.02
700715168	8' RH	32	Headless	-	XHTSCR	S20-4277	700705300	-		S35-2112	326.96
SS700715778	9' LH	36	H15-0063	700114594	XH7TSCR	S20-4268	SS700705300	-		S35-2305	415.56
SS700715778	9' LH	36	Headless	-	XH7TSCR	S20-4268	SS700705300	-		S35-2306	283.33
SS700715779	9' RH	37	H15-0063	700114594	XH7TSCR	S20-4268	SS700705300	-		S35-2309	415.23
700715778	9' LH	36	Headless	-	XHTSCR	S20-4277	700705300	-		S35-2308	251.53
700715779	9' RH	37	H15-0063	700114594	XHTSCR	S20-4277	700705300	-		S35-2311	499.67
700715779	9' RH	37	Headless	-	XHTSCR	S20-4277	700705300	-		S35-2312	255.47

MOWER CONDITIONER 1130

OEM #	Length	No. Of Sections	Head	Head OEM #	Type	Section	Section OEM #	Riveted Order No	Riveted List	Bolted Order No	List
700118673	9'	37	H15-0066	700111003	XHTSCR	S20-4277	700705300	-		S35-2071	357.41

MOWER CONDITIONER 1110

OEM #	Length	No. Of Sections	Head	Head OEM #	Type	Section	Section OEM #	Riveted Order No	Riveted List	Bolted Order No	List
700000573	7'	27	H15-0390	6821078	XHTSCR	S20-4564	049254	-		S35-2080	445.65
700111432											

MOWER CONDITIONER 1120

OEM #	Length	No. Of Sections	Head	Head OEM #	Type	Section	Section OEM #	Riveted Order No	Riveted List	Bolted Order No	List
SS700111430	9'	35	H15-0390	6821078	XH7TSCR	S20-4268	SS700705300	-		S35-2081	282.35

MOWER CONDITIONER 1150

OEM #	Length	No. Of Sections	Head	Head OEM #	Type	Section	Section OEM #	Riveted Order No	Riveted List	Bolted Order No	List
S700109341	12'	46	H15-0390	6821078	XH7TSCR	S20-4268	SS700705300	-		S35-2082	405.08

WINDROWERS 1160, 1260, 1265, 8200 CENTER PIVOT WITH 425 HEADER

OEM #	Length	No. Of Sections	Head	Head OEM #	Type	Section	Section OEM #	Riveted Order No	Riveted List	Bolted Order No	List
700709622	12'	48	H15-0066	700111003	XHTSCR	S20-4277	700705300	-		S35-2072	392.00
700709623	14'	56	H15-0066	700111003	XHTSCR	S20-4277	700705300	-		S35-2073	428.45

SICKLE HEAD

Fits HESSTON Double Drive 1170, 8400, 8450, 8020, 8600. Double needle bearing. Left hand/Right hand.

Replaces	Order No	List
700114594	H15-0063	170.84

HERSCHEL DISC MOWER KNIVES - MADE IN THE USA

- Manufactured in the U.S.A. to meet ISO 5718 standard on Knives for agricultural rotary disc mowers.
- Manufactured from high quality U.S.A. 10B38 (boron) steel.
- Edges are formed not ground to prevent edges from chipping & breakage.
- Entire knife is belt, not batch heat treated to a RC hardness of 45-52. Batch heat treating can cause knives on the inside of the batch to vary greatly in hardness compared to knives on the outside of the batch.
- Each knife is stamped with our name, date and lot number to allow us to trace the manufacturing process on each knife. This allows traceability of the steel back to the steel mill and the mills heat lot of the steel used in the knife.

DISC MOWER KNIVES

Fits HESSTON 1004, 1005, 1006, 1007, 1008, 3006, 3007, 3008, 3009, 3010, 3309.

Length: 4.76" Degree of Twist: 13 Hole Diameter: .89
Width: 1.88 Thickness: 0.165 Center Of Hole To Back Edge: .78

OEM Number	Style	Shape	Bolt Order No	6 Blades Order No	List	25 Blades Order No	List
527746	5	RH Twisted	B55-0355D	B45-6563D	16.05	B45-6563	62.90
527747	5	LH Twisted	B55-0355D	B45-6564D	16.05	B45-6564	62.90



DISC MOWER KNIVES

Fits HESSTON 1030, 1035, 1040, 1050, 1060.

Length: 3.66" Degree of Twist: 13 Hole Diameter: .64
Width: 1.60 Thickness: 0.116 Center Of Hole To Back Edge: .80

OEM Number	Style	Shape	Bolt Order No	6 Blades Order No	List	25 Blades Order No	List
DM303	4	LH Twisted	B55-0358D	B45-6996D	15.56	B45-6996	46.70
DM304	4	RH Twisted	B55-0358D	B45-6997D	15.56	B45-6997	54.42



DISC MOWER KNIVES

Fits HESSTON 1320, 1340, 1345, 1355, 1360, 1365, 1375, 3312, 3315, 8070, 8500, 9070, 9075, 9080, 9190, 9192

Length: 4.21" Degree of Twist: 13 Hole Diameter: .72
Width: 1.78 Thickness: 0.169 Center Of Hole To Back Edge: .80

OEM Number	Style	Shape	Bolt Order No	6 Blades Order No	List	25 Blades Order No	List
700713983	4	RH Twisted	B55-0344D	B45-6568D	15.03	B45-6568	59.94
700713984	4	LH Twisted	B55-0344D	B45-6569D	15.03	B45-6569	59.94



DISC MOWER KNIVES - 18 DEGREE TOP BEVEL

Fits HESSTON 8070, 1320, 1340, 1360, 1365

Length: 4.21" Degree of Twist: 18 Hole Diameter: .73
Width: 1.89 Thickness: 0.157 Center Of Hole To Back Edge: .75

OEM Number	Shape	Bolt Order No	6 Blades Order No	List	25 Blades Order No	List
86625673	LHTwisted	B55-0342D	B45-6725D	17.95	B45-6725	62.31
86625674	RHTwisted	B55-0342D	B45-6726D	17.95	B45-6726	62.31

DISC MOWER KNIVES - 18 DEGREE BOTTOM BEVEL

Fits HESSTON 8070, 1320, 1340, 1360, 1365

Length: 4.21" Degree of Twist: 18 Hole Diameter: .73
Width: 1.88 Thickness: 0.163 Center Of Hole To Back Edge: .78

OEM Number	Shape	Bolt Order No	6 Blades Order No	List	25 Blades Order No	List
86625673	LHTwisted	B55-0342D	B45-6572D	16.74	B45-6572	60.96
86625674	RHTwisted	B55-0342D	B45-6573D	16.74	B45-6573	60.96

DISC MOWER KNIVES

Fits HESSTON 8500.

Length: 4.21" Degree of Twist: 13 Hole Diameter: .73
Width: 1.86 Thickness: 0.157 Center Of Hole To Back Edge: .78

OEM Number	Style	Shape	Bolt Order No	6 Blades Order No	List	25 Blades Order No	List
700715576	5	RH Twisted	B55-0342D	B45-6559D	14.35	B45-6559	57.98
700715575	5	LH Twisted	B55-0342D	B45-6560D	14.35	B45-6560	57.98



RAKE TOOTH

For HESSTON 3700,3800, 3810, 3900, 3950. 100 per box.

Order No.	List
T16-0185	5.07



SPRING TOOTH

For HESSTON Windrowers, Pickup and Forage Harvester. Replaces 7894751. 100 per box.

Order No.	List
T16-0012	18.96



SPRING TOOTH

For HESSTON Windrowers PT-10 420, 620, 6600 & 1014. Replaces 750075. 100 per box.

Order No.	List
T16-0030	18.96



BALER TOOTH

For HESSTON Baler, Large Round, 5600 & 5800. Replaces 7751621. 100 per box.

Order No.	List
T16-0040	18.96

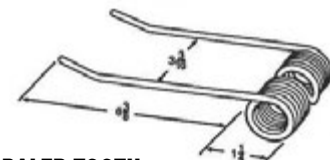

BALER TOOTH

For HESSTON 4900. Replaces 700706128. 100 per box.

Order No.	List
T16-0163	18.96

BALER TOOTH

For HESSTON 48W, 1 TON FREEMAN. Replaces 7893746. 100 per box.

Order No.	List
T16-0164	18.96

HONEY BEE

HERSCHEL sections are made in the USA from high quality boron steel. Heat-treated for long life. Sections are extra heavy (.116") and chrome unless stated otherwise.

WHY TRY TIGER SHARK™ SECTIONS?

1. Serrated teeth allow more cutting surface.
2. They last longer, cut faster.
3. Cuts equally well in soybeans, alfalfa, grass hay, wheat, etc.



Customer Testimonial:

"I cut over 1000 acres of soybeans with the same *Herschel Tiger Shark™* sections. They stayed sharper longer and lasted longer than any section I have used." - Roger Woodruff, Warren Co. Iowa



S20-8498 S20-4498 S20-3513

SECTIONS

Fits HONEY BEE Heads with Schumacher Easy Cut System. Sold 10 sections per pack.

The *Tiger Shark™* section can be used in place of the sections listed below.

OEM #	Description	Order No	List
26208	Tiger Shark™	S20-8498	19.51
26208	XH7TSCR	S20-4498	19.51
26208	XH7TS	S20-3513	24.35

SECTION TYPES

- | | |
|--------------------------------|--------------------|
| 7TS = Super 7® Top Serrated | TT = Tiger Tooth |
| SM = Smooth | TJ = Tiger Jaw |
| US = Under Serrated - 14 Tooth | SRK = Tiger Shark™ |
| TS = Top Serrated - 14 Tooth | |

SECTION BOLT/NUT

Used on Honey Bee headers with SCH cutting systems. Replaces 420100012, 61711. M6-1.0x16. 50 per package.

Order No.	List
B55-0075D	29.40



HERSCHEL sections are made in the USA from high quality boron steel. Heat-treated for long life. Sections are extra heavy (.116") and chrome unless stated otherwise.

SECTION TYPES

- | | |
|--------------------------------|--------------------|
| 7TS = Super 7® Top Serrated | TT = Tiger Tooth |
| SM = Smooth | TJ = Tiger Jaw |
| US = Under Serrated - 14 Tooth | SRK = Tiger Shark™ |
| TS = Top Serrated - 14 Tooth | |



SECTION - XHUS
Fits JE LOVE Green Pea Wind-
rowers. Section is 3" x 3-3/16".
Use 9/16 OH Rivet. Sold 10 sec-
tions per pack.

Replaces			
Number	Order No	List	
L191	S20-5246	17.41	



SECTION - XH7TS
Fits JE LOVE TR308, TR310.
Section is 3" x 3". Use 5/8 CS
Rivet. Sold 10 sections per
pack.

Replaces			
Number	Order No	List	
L192DS7	S20-3370	22.70	



SECTION - XHTSCR
Fits JE LOVE TR409, TR510.
Section is 3" x 3". Use 5/8 CS
Rivet. Sold 10 sections per
pack.

Replaces			
Number	Order No	List	
L192DCR	S20-4608	27.87	



SECTION - XHTJCR
Fits JE LOVE Combines with
Tiger Jaws, King Kut. Section
is 3" x 3-1/4". Sold 10 sections
per pack.

Replaces			
Number	Order No	List	
TJ6000	S20-4638	24.64	



SECTION - XH7TJCR
Fits JE LOVE Combines with
Tiger Jaws, King Kut. Section
is 3" x 3-1/4". Sold 10 sections
per pack.

Replaces			
Number	Order No	List	
SSTJ6000	S20-4316	27.28	



WEAR PLATE - 6"
Standard and Adjustable.

Replaces			
Number	Order No.	List	
L220	P44-0417	3.00	

**Get Online With
Herschel Parts!**

HERSCHELPARTS.com

You can shop 24 hours a
day. 7 Days A Week!

We are also on Facebook
and Twitter! Check out our
pages today and stay up-to-
date on all the things going
on at Herschel!

SECTION BOLTS

- Quick and easy section changes are possible with bolts.
- No more cutting, chiseling, or grinding - simply unbolt the section, replace and tighten bolts.
- Bolts will not turn in Knife Back and are reusable. They will last thru the life of several sections.
- Bolts may be replaced easily if accidentally damaged or broken.
- No special tools are needed to change sections, only a 7/16 wrench or socket.
- Bolt and nuts hold better than rivets and they have a greater clamp load than rivets.
- Special lock nuts will not vibrate loose.

Description	Application	Pkg.	Qty. Mst Ctn.	Order No	List
Section Bolt*	Countersink, replaces 5/8 CS rivets. 60° Head	20	120	B55-0057D	6.31
Head Bolt*	Countersink, replaces 1 CS rivets	10	6	B55-0058D	10.68

* Use with Allen Wrench

FORGED STEEL GUARD

Fits JE LOVE. Replaces FC90-2,
BU275, LB208, LB214, HA275.

Order No	List
G81-0196	13.40



FORGED STEEL GUARD

Fits all TIGER JAWS. Replaces
TJ44-4A. 4-Prong.

Order No	List
G81-0581	24.17



GUARD BOLT

#3 bolt. Replaces L1316,
L1317. 50 bolts/nuts per
package. 7/16" x 1-1/2".

Order No	List
B55-0260	33.96



GUARD BOLT

#3 bolt. Replaces LB318.
50 bolts/nuts per package.
7/16" x 1-3/4".

Order No	List
B55-0265	28.02



BOLTED SICKLES, SPLICED HEADLESS

Fits Both the Original Tiger Jaws and the
Tiger Jaws 2000 Series, now all with Super
7 Sections.

Size	Order No	List
1-Piece Universal		
16'	S35-2153	458.01
20'	S35-2155	560.55
Spliced Universal		
4'	S35-2860	107.59
5'	S35-2276	138.98
8'	S35-2861	183.92
8.5' Drive	S35-2862	185.10
Head Segment		

TIGER JAWS



S35-2860/2861



S35-2862

B	
Bale Counter.....	35
Baler Bearings.....	48
Baler Sprockets, Round.....	47 - 48
Baler Teeth.....	45
Bearings, Plastic Reel.....	46
Bolts, Section.....	36
D	
Disc Mower Knives.....	43
C	
Clips, Hold Down.....	36
Combine Teeth.....	45
Corn Head Rollers.....	46
E	
End Sections.....	35
G	
Gathering Chain Sprockets.....	46
Grass Board.....	35
Guards.....	44
H	
Hold Down Clips.....	36
K	
Kits, Overlap Section.....	35
O	
Overlap Section Kits.....	35
P	
Pick-Up Teeth.....	45
Plastic Reel Bearings.....	46
Plastic Tines.....	45
Poly Replacement Parts.....	45

R	
Rake Teeth.....	45
Rake Wheels.....	46
Reel Tines.....	45
Rivets, Section.....	36
Round Baler Bearings.....	48
Round Baler Sprockets.....	47 - 48
S	
Sections.....	33 - 34
Section Bolts.....	36
Section Rivets.....	36
Sickle Knife.....	39
Sickle Heads.....	42
Sickles.....	37 - 41
Splice Kits.....	40
Spliced Sickles.....	40 - 41
Sprockets, Round Baler.....	48
Sprockets, Gathering Chain.....	46
T	
Teeth, Baler.....	45
Teeth, Combine.....	45
Teeth, Pick-up.....	45
Tines, Reel.....	45
Tooth, Rake.....	45
W	
Wear Plate.....	42

HERSCHEL sections are made in the USA from high quality boron steel. Heat-treated for long life. Sections are extra heavy (.116") and chrome unless stated otherwise.

All JOHN DEERE sections for combines have 2-1/16" hole spacing.
All JOHN DEERE sections for hay machines have 2" hole spacing.

SECTION TYPES

7TS = Super 7® Top Serrated TT = Tiger Tooth
 SM = Smooth TJ = Tiger Jaw
 US = Under Serrated - 14 Tooth SRK = Tiger Shark™
 TS = Top Serrated - 14 Tooth

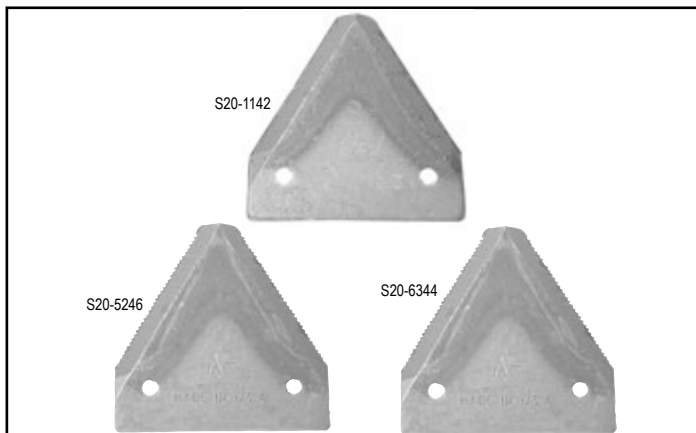

SECTIONS

Fits JOHN DEERE **Mowers, Mower Conditioners and Windrowers.** Section is 3" x 3-3/16". Uses 9/16 OH rivet. Sold 10 sections per pack.

OEM #	Description	Design	Order No	List
E76372, Z6451H	XHSM	H	S20-1142	20.47
E76373, Z7030H	XHUS	A-	S20-5246	17.41
E76371, H21530H	XHUSCR	A-	S20-6344	31.31

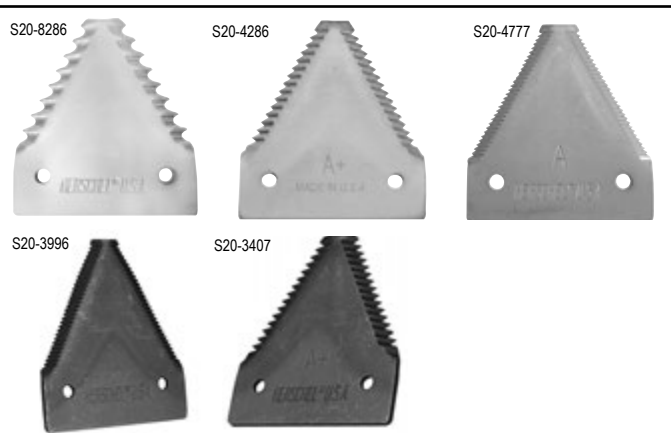

SECTIONS

Fits JOHN DEERE **Mowers, Conditioners and Windrowers.** Section is 3" x 3-1/16". Uses 9/16 OH rivet. Sold 10 sections per pack. Replaces E45996, E76370 and E90571.

The Tiger Shark™ section can be used in place of the sections listed below.

Description	Design	Order No	List
Tiger Shark™		S20-8286	20.91
XH7TSCR	A+	S20-4286	19.87
XHTSCR	A	S20-4777	24.35
XHTS	A	S20-3996	19.34
XH7TS	A+	S20-3407	17.27
Tiger Shark™ (TopCS)	A+	S20-8328	39.51
Tiger Shark™ (BtmCS)	A+	S20-8329	40.31



SECTIONS

Fits JOHN DEERE **140, 140A, 160A, 180A Auger Heads, 415D, 420D, 425D, 430D, 435D, 440D, 160 Series Draper Heads, 580 & 90 Windrowers, Mower Conditioners 1212, 1214 & 1216.** Section is 3" x 3-1/4". Uses 5/8 OH rivet. Sold 10 sections per pack.

The Tiger Shark™ section can be used in place of the sections listed below.

OEM #	Description	Design	Order No	List
	Tiger Shark™		S20-8398	19.51
W34602CR, W35888CR	XH7TSCR	C+	S20-4398	19.51
W34602CR, W35888CR	XHTSCR	C	S20-4170	26.18
W34602, W35888	XHTS	5/8 OH	S20-3283	20.00



SECTIONS

Fits JOHN DEERE **Windrower, 300 Twin Drive Header.** Section is 3" x 3-3/16". Uses 5/8 CS rivet. Sold 10 sections per pack.

OEM #	Description	Design	Order No	List
E71947	XHTSCR(Top CS)	A	S20-4130	27.72
E71947	XH7TSCR(TopCS) - overlap section	A+	S20-4328	36.09
E71948	XH7TSCR(BtmCS) - overlap section	A+	S20-4329	36.78



SECTIONS

Fits JOHN DEERE Windrower 580, 590, 2360. Section is 3" x 3-1/4". Uses 9/16 OH rivet. Sold 10 sections per pack.

OEM #	Description	Design	Order No	List
W30344, W36402	XHUS	C-	S20-5743	22.24



SECTION - XHTSCR

Fits JOHN DEERE Windrower 2360, Overlap. Section is 3" x 3-7/32". Uses 5/8 OH Rivet. Sold 10 sections per pack.

OEM#	Order No	List
34390CR-CSK	S20-4399	32.06

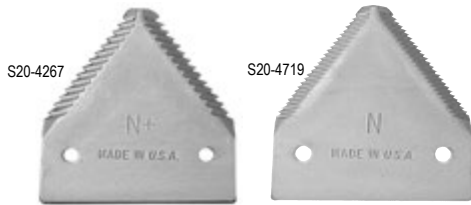

SECTIONS

Fits JOHN DEERE Combines with 200 & 900 series headers. Section is 3" x 3-1/4". Uses 5/8 OH Rivet. Sold 10 sections per pack.

OEM #	Description	Design	Order No	List
H84415, H213805	XH7TSCR	N+	S20-4267	27.73
H84415, H130478, H213815	XHTSCR	N	S20-4719	27.87

SECTION

Fits JOHN DEERE 600 Series Double Drives. Top countersunk. Section is 3" x 4". Uses bolt B55-0075D. Sold 10 sections per pack.



OEM#	Description	Order No	List
H226351	Tiger Shark™	S20-8540	79.95
H226351	XH7TSCR	S20-4540	78.95



SECTIONS

Fits JOHN DEERE 200 and 900 series headers. Section is 3" x 3-1/4". Uses bolt B55-0065D. Sold 10 sections per pack. 2 hole section.

The Tiger Shark™ section can be used in place of the sections listed below.

OEM #	Description	Design	Order No	List
	Tiger Shark™		S20-8452	20.13
H136807, H207930	XH7TSCR	N+	S20-4452	20.13
H136807, H207929	XHTSCR	N	S20-4451	25.71



SECTIONS

Fits JOHN DEERE 600 Rigid & Flex, 900 Draper Headers. Section is 3" x 4". Use bolt B55-0600D. Sold 10 sections per pack.

The Tiger Shark™ section can be used in place of the sections listed below.

OEM #	Description	Order No	List
	Tiger Shark™	S20-8531	31.33
H163131	XH7TSCR	S20-4531	31.33
H153329	XHTSCR	S20-4532	39.12



SECTIONS

Fits JOHN DEERE 600 Rigid & Flex, 900 Draper Headers. Section is a half section. Uses bolt B55-0075D. Sold 10 sections per pack. The Tiger Shark™ section can be used in place of the sections listed below.

OEM #	Description	Order No	List
H163132	XH7TSCR	S20-4537	45.46
H163132	Tiger Shark™	S20-8537	65.13
H161242	XHTSCR	S20-4536	45.46
H163132	XH7TSCR	S20-4537D*	12.50
H161242	XHTSCR	S20-4536D*	12.50

*Sold as a 2 pack.



TIGER JAW SECTIONS

Fits JOHN DEERE Combines with Tiger Jaw systems. Section is 3" x 3-1/4". Uses bolt B55-0065D. Sold 10 sections per pack.

Description	Design	Order No	List
XHTJCR	R	S20-4639	27.29
XH7JCR	R+	S20-4317	27.28
Blank 1/2 Section		S20-0297	36.74

1-YEAR WARRANTY ON ALL ITEMS!



TIGER TOOTH SECTION
Fits JOHN DEERE Mowers and Mower Conditioners. Section is 3" x 3-1/8". Uses bolt B55-0065D. Sold 10 sections per pack. Replaces TTE45996.

Description	Order No	List
XH7TTCR	S20-4414	26.32



TIGER TOOTH SECTIONS - XH7TTCR
Fits JOHN DEERE Windrower Overlap section. Section is 3" x 3-1/8". Uses bolt 5/8 CS rivet. Sold 10 sections per pack.

Replaces	Description	Order No	List
SSTTE71948	Bottom Countersunk	S20-4416	15.15

MOWER/CONDITIONER OVERLAP SECTION KIT FOR DOUBLE DRIVES
Fits JOHN DEERE Mower and Mower Conditioner 300 Twin Drive Headers. Kit includes 1 of S20-4131, 3 of S20-4130 and 8 B55-0059 countersunk bolts and nuts.

Order No	List
S20-4002	32.14

MOWER/CONDITIONER OVERLAP SECTION KIT FOR DOUBLE DRIVES
Fits JOHN DEERE 300, 1600, 890, 4890 Mowers. Kit includes 6 sections and 10 countersunk bolts and nuts.

Order No	List
S20-4006	32.00

GRASS BOARD
Fits all mowers.



Order No	List
B52-0615	67.69

BALE COUNTER
Bale counter, reads up to 99,999. 4-hole mounting plate, push button reset, adjustable side arm. Fits most balers.



Order No	List
T55-0002	30.62

Our Agricultural Background - Cutting Parts

Founded in 1887, by two brothers, Paul E and H. Robert Herschel. R. Herschel Manufacturing quickly became a leader in the sickle section industry.

For more than 130 years HERSCHEL has been an innovator in the cutting parts industry and introduced the chrome plated section (1950), Tiger Jaw® (1981) and Tiger Jaw 2000® (1997) combine conversion kits, Super 7® sections (1992) and most recently the Tiger Shark™ section (2016). Cutting parts designed to provide the agricultural industry with a high quality product at an exceptional value. We are proud to still make our popular cutting products at our factory in Indianola, IA.

COMBINE OVERLAP SECTION KIT - XH7TSCR
Fits JOHN DEERE 600 SERIES HEADERS. Includes 5 countersunk sections, 1 overlap rectangle plate, 12 6MM CTSK bolts, 12 6MM nuts.

Order No	List
S20-4011	76.49

COMBINE OVERLAP SECTION KIT - TIGER SHARK
Fits JOHN DEERE 600 SERIES HEADERS. Includes 5 countersunk sections, 1 overlap rectangle plate, 12 6MM CTSK bolts, 12 6MM nuts.

Order No	List
S20-4012	76.49

WHY TRY TIGER SHARK™ SECTIONS?

1. Serrated teeth allow more cutting surface.
2. They last longer, cut faster.
3. Cuts equally well in soybeans, alfalfa, grass hay, wheat, etc.



Customer Testimonial:

"I cut over 1000 acres of soybeans with the same Herschel Tiger Shark™ sections. They stayed sharper longer and lasted longer than any section I have used." - Roger Woodruff, Warren Co. Iowa

UNIVERSAL END SECTIONS
HERSCHEL "End Sections" are made of one-piece high carbon, heat-treated steel for rugged use. They are punched with an oblong hole to virtually fit any standard cutterbar mower in use today. To install our "End Section", simply take off the last section on the shoe end of your sickle assembly and replace it with an "End Section". The change-over takes only a couple of minutes to complete and you will notice a big difference in time saved from unclogging your mower. We recommend using an R36-0523D oval head rivets or B55-0065D Bolts.



Description	Order No	List	Description	Order No	List
XH7TSCR (RH) 10/Box	S20-4403	59.59	Tiger Shark™ (LH) 2/SP	S20-8445D	18.67
XH7TSCR (RH) 2/SP	S20-4403D	16.31	XHTS CR (RH) 10/Box	S20-4210	59.59
Tiger Shark™ (RH) 10/Box	S20-8403	64.31	XHTS CR (RH) 2/SP	S20-4210D	16.31
Tiger Shark™ (RH) 2/SP	S20-8403D	11.44	XHTSCR (LH) 10/Box	S20-4211	59.59
XH7TSCR (LH) 10/Box	S20-4445	63.81	XHTSCR (LH) 2/SP	S20-4211D	16.31
XH7TSCR (LH) 2/SP	S20-4445D	11.26	XHUSCR (RH) 10/Box	S20-6640	63.12
Tiger Shark™ (LH) 10/Box	S20-8445	64.31	XHUSCR (RH) 2/SP	S20-6640D	16.31

1-YEAR WARRANTY ON ALL ITEMS!

SECTION BOLTS

Description	Application	Qty. Pkg.	Qty. Mstr Ctn.	Order No.	List
Section Bolt w/Nut	Universal - Replaces 9/16" & 5/8" OH Rivets	50	300	B55-0065D	12.28
Section Bolt w/Nut	600 Series Flex & Rigid Headers M6-1.0x16	50		B55-0075D*	29.40
Head Strap Bolt	600 Series Flex & Rigid Headers M6-1.0x20	11		B55-0076D*	16.55
Head Section Bolt w/Nut	600 Series Flex & Rigid Headers M6-1.0x25	9		B55-0077D*	21.84
Splice Bolt & Nut	600 Series Flex & Rigid Headers	20		B55-0078D*	22.09
Head Bolt w/Nut	Universal - Replaces 1" & 1-1/16" OH Rivets	15	90	B55-0085D	7.31
Head Bolt w/Nut	Universal - Replaces 1-1/4" OH Rivets	12	72	B55-0095D	7.51
Section Bolt w/Nut	Universal - Bolts for 10' Sickle w/head bolts (80 -B55-0065D, 5 - B55-0085D, 5-B55-0095D)	90	Each	B55-0500D	28.42
Head Bolt w/Oval Shank	600, 700 (15 - 20 mm bolts & nuts, 10 - 25mm bolts & nuts) H158342 AND H158343.	25		B55-0601D**	54.62
Section Bolt W/Oval Shank	600, 700 Series Flex & Rigid Headers. H158341, H158343.	50		B55-0600D**	47.97
Overlap Bolt/Nut	600, 700 Series Flex & Rigid Headers.	10		B55-0602D	9.33
1/2" CS Overlap Bolt w/Low Profile Nut	Double Drive Hay Sickles (use with Allen Wrench)	10	60	B55-0059D	9.40
Nut, Full	Universal for all above bolts	20	120	N83-0289D	6.70
Nut, Low Profile	Overlap Hay	20	120	N83-0295D	6.90

*For sickles using ribbed shoulder section bolts. **For sickles using oval shoulder section bolts.



RIVETS

Size / No. in Pkg.	Description	Application	Qty. Pkg.	Qty. Ctn.	Order No.	List
5/8" # 5-1/2 (56)	OH Rivets Asst.	7" Heavy Mower Sections	Asst.	6	R36-0523D	10.70
1" # 5-1/2 (10)	Zinc Pltd.	and Knife Heads				
5/8" # 5-1/2 (72)	OH Rivets Asst.	9" Mower Conditioners	Asst.	6	R36-0524D	12.31
1" # 5-1/2 (5)	Zinc Pltd.					
1-1/4" # 5-1/2 (5)						
1-1/4" OH	OH Rivets Zinc Plt.	Head Rivet	1/2#	3	R36-0467D	8.53
5/8" OH	OH Rivets Zinc Plt.	Heavy Gauge Sections	1#	6	R36-0462D	16.74
15/16" OH	OH Rivets Zinc Plt.	Head Rivet	1/2#	3	R36-0522D	9.11
1-1/4" CS	CS Rivets Zinc Plt.	Guard Plate Rivet	1/2#	3	R36-0468D	8.28
5/8" CS	CS Rivets Zinc Plt.	Section Rivet	1#	6	R36-0463D	13.66



HOLD DOWN CLIPS NON-ADJUSTABLE

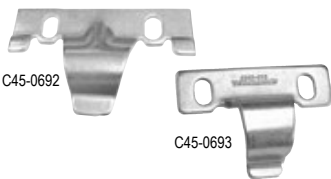

Fits all JOHN DEERE Combines and Mowers. Steel.

Style	Order No.	List
Low Arch	C45-0692	5.55
High Arch	C45-0693	7.45

HOLD DOWN CLIPS ADJUSTABLE



Fits all JOHN DEERE Mowers, Windrowers, & Swathers. Cast.

Style	Order No.	List
Low Arch	C45-0006	37.80
High Arch	C45-0007	37.80

Fits most JOHN DEERE Combines, Mowers & Windrowers. Steel.

Style	Order No.	List
Low Arch	C45-0040	9.05



Fits most JOHN DEERE 600, 700 Series. Cast.

Replaces	Style	Order No.	List
AH218547	Low Arch	C45-0620	12.20
AH218548	High Arch	C45-0625	11.83

SICKLES

MOWERS 2, 5, 7B, 7D, 8, 8W, 9, 9W, 11, 20A, 37, 38, 39, 39N, 51

OEM #	Length	No. Of Sections	Head	Head OEM #	Type	Section	Section OEM #	Riveted Order No	Riveted List	Bolted Order No	Bolted List
AZ955H, AZ3987H	7'	28	H15-0282	AZ955H, H28076	XHSM	S20-1142	E76372, Z6451H	S35-3725	192.02	-	-
AZ1299H	7'	28	H15-0282	AZ955H, H28076	XHUS	S20-5246	E76373, Z7030H	S35-3548	175.76	S35-1288	235.83
AZ3987H	9'	36	H15-0282	AZ955H, H28076	XHSM	S20-1142	E76372, Z6451H	S35-3587	247.17	-	-
AZ3988H	9'	36	H15-0282	AZ955H, H28076	XHUS	S20-5246	E76373, Z7030H	S35-3588	213.49	-	-

MOWERS 47, 50, 250, 350, 450, 3700 WITH NEEDLE BEARING STYLE HEAD

OEM #	Length	No. Of Sections	Head	Head OEM #	Type	Section	Section OEM #	Riveted Order No	Riveted List	Bolted Order No	Bolted List
AE48592, AE36097	7'	28	H15-0335	AE35450, AE47891, AE48587	XHUS	S20-5246	E76373, Z7030H	S35-3004	225.79	-	-
AE48593, AE36101	7'	28	H15-0335	AE35450, AE47891, AE48587	XHSM	S20-1142	E76372, Z6451H	S35-3001	296.58	-	-
SSAE48593, SSAE36101	7'	28	H15-0335	AE35450, AE47891, AE48587	XH7TSCR	S20-4286	SSE45996, SSE76370	-	-	S35-2455	313.18
AE48594, AE36102	9'	36	H15-0335	AE35450, AE47891, AE48587	XHUS	S20-5246	E76373, Z7030H	S35-3003	261.74	S35-1709	316.03
AE48594, AE36102	9'	36	H15-0335	AE35450, AE47891, AE48587	XHTS	S20-3996	E76370, E45996	S35-3005	315.48	-	-

MOWER CONDITIONERS 480, 483, 485, 780, 800 BOTH WITH 78 DRAPER HEADER, 1209 S/N 285000-EARLIER, 2280, 2320, 2420 ALL THREE WITH 240 AUGER HEADER TIE ROD HEAD STYLE

OEM #	Length	No. Of Sections	Head	Head OEM #	Type	Section	Section OEM #	Riveted Order No	Riveted List	Bolted Order No	Bolted List
AE27602	9'	37	Headless	AE24247	XHTSCR	S20-4777	E45996, E76370	S35-4354	371.58	-	-

WINDROWERS 4890 DOUBLE DRIVE, 4895, 4995 SELF- PROPELLED USING 890, 895, 896 AUGER PLATFORMS

OEM #	Length	No. Of Sections	Head	Head OEM #	Type	Section	Section OEM #	Riveted Order No	Riveted List	Bolted Order No	Bolted List
AE51995, AE57037	14' LH	29	H15-0417	AE54468	XH7TSCR	S20-4286	SSE45996, SSE76370	-	-	S35-2330	307.56
AE51996, AE57038	14' RH	29	H15-0417	AE54468	XH7TSCR	S20-4286	SSE45996, SSE76370	-	-	S35-2332	307.55
AE51795, AE57039	16' LH	33	H15-0417	AE54468	XH7TSCR	S20-4286	SSE45996, SSE76370	-	-	S35-2331	346.09
AE51796, AE57040	16' RH	33	H15-0417	AE54468	XH7TSCR	S20-4286	SSE45996, SSE76370	-	-	S35-2334	346.09
AE51997, AE57041	18' LH	37	H15-0417	AE54468	XH7TSCR	S20-4286	SSE45996, SSE76370	-	-	S35-2333	345.91
AE51998, AE57042	18' RH	37	H15-0417	AE54468	XH7TSCR	S20-4286	SSE45996, SSE76370	-	-	S35-2335	345.91

WINDROWERS 1207, 1209 S/N 285000-LATER, 1217, 1219

OEM #	Length	No. Of Sections	Head	Head OEM #	Type	Section	Section OEM #	Riveted Order No	Riveted List	Bolted Order No	Bolted List
AE34769, AE41758, AE48664	9'	37	H15-0362* Riveted H15-0786* Bolted	AE48125	XHTSCR XH7TSCR	S20-4777	E76370, E45996	S35-4873	283.44	-	-
AE41703, AE48662	9'	37		AE48125	Tiger Shark™ XHUSCR	S20-8286 S20-6344	E76371, H21530H	S35-4868	263.20	S35-2012	310.62
										S35-2526	286.54
										S35-2936	323.80

SICKLES

WINDROWERS 2280, 2320, 2420 USING 230, 240 AUGER PLATFORM OR 130, 135 DRAPER HEADER

OEM #	Length	No. Of Sections	Head	Head OEM #	Type	Section	Section OEM #	Riveted Order No	Riveted List	Bolted Order No	Bolted List
SSAE34769, SSAE41758 SSAE48664	9'	37	H15-0786*	AE48125	XH7TSCR	S20-4286	SSE45996, SSE76370	-		S35-2012	310.62
AE34769, AE41758 AE48664	9'	37	H15-0362*	AE48125	XHTSCR	S20-4777	E76370, E45996	S35-4873	283.44	-	
AE41703, AE48662	9'	37	H15-0362* Riveted H15-0786* Bolted	AE48125	XHUSCR	S20-6344	E76371, H21530H	S35-4868	263.20	S35-2936	323.80
SSAE34769, SSAE1758 SSAE48664	9'	37	H15-0786*	AE48125	XH7TSCR	S20-4286	SSE45996, SSE76370	-		S35-2012	310.62
AE35791, AE48652	12'	49	H15-0362* Riveted H15-0786* Bolted	AE48125	XHTSCR	S20-4777	E76370, E45996	S35-4133	465.41	S35-2290	441.07
AE35809, AE48654	14'	57	H15-0362* Riveted H15-0786* Bolted	AE48125	XHTSCR	S20-4777	E76370, E45996			S35-2711	515.42
AE35846, AE48657	16'	65	H15-0362*	AE48125	XHTSCR	S20-4777	E76370, E45996	S35-4132	522.07	-	
SSAE35846, SSAE48657	16'	65	H15-0786*	AE48125	XH7TSCR	S20-4286	SSE45996, SSE76370	-		S35-2460	569.55
SSAE31931, SSAE48599	18'	71	H15-0786*	AE48125	XH7TSCR	S20-4286	SSE45996, SSE76370	-		S35-2461	591.75
SSAE28115, SSAE48598	21'	83	H15-0786*	AE48125	XH7TSCR	S20-4286	SSE45996, SSE76370	-		S35-2462	674.05

MOWER CONDITIONERS 1380 MID-PIVOT HYDRO SHIFT, 1424

OEM #	Length	No. Of Sections	Head	Head OEM #	Type	Section	Section OEM #	Riveted Order No	Riveted List	Bolted Order No	Bolted List
AE35791, AE48652	12'	49	H15-0362* Riveted H15-0786* Bolted	AE48125	XHTSCR	S20-4777	E76370, E45996	S35-4133	465.41	S35-2290	441.07
AE35809, AE48654	14'	57	H15-0362* Riveted H15-0786* Bolted	AE48125	XHTSCR	S20-4777	E76370, E45996			S35-2711	515.42

MOWER CONDITIONERS 1525, 3430, 3830 ALL USING 300 TWIN KNIFE HEAD, 1600, 1600A BOTH USING 300 AUGER PLATFORM

OEM #	Length	No. Of Sections	Head	Head OEM #	Type	Section	Section OEM #	Riveted Order No	Riveted List	Bolted Order No	Bolted List
AE43511, AE48135	14' RH	28	H15-0363*	AE48126	XHTSCR	S20-4777	E76370, E45996	S35-4138	333.24	-	
SSAE43511, SSAE48135	14' RH	28	H15-0787*	AE48126	XH7TSCR	S20-4286	SSE45996, SSE76370	-		S35-2300	349.87
AE43520, AE48131	14' LH	29	H15-0362*	AE48125	XHTSCR	S20-4777	E76370, E45996	S35-4139	445.25	-	
SSAE43520, SSAE48131	14' LH	29	H15-0786*	AE48125	XH7TSCR	S20-4286	SSE45996, SSE76370	-		S35-2301	349.87
SSAE43510, SSAE48134	16' RH	32	H15-0787*	AE48126	XH7TSCR	S20-4286	SSE45996, SSE76370	-		S35-2021	341.71
AE43519, AE48130	16' LH	33	H15-0362*	AE48125	XHTSCR	S20-4777	E76370, E45996	S35-4141	482.32	-	
SSAE43519, SSAE48130	16' LH	33	H15-0786*	AE48125	XH7TSCR	S20-4286	SSE45996, SSE76370	-		S35-2020	341.71
SSTTAE43511, SSTTAE48135	14' RH	28	H15-0789*	TTAE48125	XH7TTCR	S20-4414	SSTTE45996, SSTTE76370	-		S35-2391	367.14
SSTTAE43520, SSTTAE48131 SSTTE76370	14' LH	30	H15-0788*	TTAE48125	XH7TTCR	S20-4414	SSTTE45996,	-		S35-2390	367.12

MOWER CONDITIONERS 710, 720, 820

OEM #	Length	No. Of Sections	Head	Head OEM #	Type	Section	Section OEM #	Riveted Order No	Riveted List	Bolted Order No	Bolted List
SSAE49203	9' 9"	39	H15-0406	AE49854	XH7TSCR	S20-4286	SSE45996,	-		S35-2270	338.29

SICKLES

WINDROWERS 580, 590 PULL-TYPE, 2360 USING 160 DRAPER HEADER

OEM #	Length	No. Of Sections	Head	Head OEM #	Type	Section	Section OEM #	Riveted Order No	Riveted List	Bolted Order No	Bolted List
SSAW20651, SSCXM15191 SSCXM38634	18'	71	Headless	-	XH7TSCR	S20-4398	SS34390CR	-		S35-2262	464.45
SSAW20652, SSAW25030 SSCXM43074 SSCXM49667	21'	83	Headless	-	XH7TSCR Tiger Shark™	S20-4398 S20-8398	SS34390CR	-		S35-2253 S35-2553	461.04 388.35

COMBINES 3300, 4400, 4420, 6600, 6620, 7700, 7720, 8820 USING 200 SERIES RIGID HEADERS OR 213-230 FLEXHEAD PLATFORM, 9400, 9500, 9600 USING 900 SERIES RIGID HEADERS

OEM #	Length	No. Of Sections	Head	Head OEM #	Type	Section	Section OEM #	Riveted Order No	Riveted List	Bolted Order No	Bolted List
AH121076, AH140382	13'	50	H15-0004	AH121075	XH7TSCR	S20-4267	SSH84415, SSH130478	-		S35-2536	473.40
AH128721	16'	62	H15-0004	AH121075	XH7TSCR	S20-4267	SSH84415, SSH130478	-		S35-2538	505.90
AH121081	20'	78	H15-0004	AH121075	XH7TSCR	S20-4267	SSH84415, SSH130478	-		S35-2540	625.05
AH121085	24'	94	H15-0004	AH121075	XH7TSCR	S20-4267	SSH84415, SSH130478	-		S35-2542	806.54
AH121221	25'	100	H15-0004	AH121075	XH7TSCR	S20-4267	SSH84415, SSH130478	-		S35-2108	730.15
N/A	6' Ext. w/splice	24	Headless	N/A	XH7TSCR	S20-4267	SSH84415, SSH130478	-		S35-2543	183.25

SICKLE/KNIFE BACKS			
Fits JOHN DEERE Mowers 5, 8, 9, 11, 37, 38, 39			
OEM#	Size	Order No.	List
JD 7	7'	S35-6091	49.24
JD 9	9'	S35-6108	80.63

Get Online With Herschel Parts!

www.HERSCHELPARTS.com

You can shop 24 hours a day. 7 Days A Week!
We are also on Facebook and Twitter! Check out our pages today and stay up-to-date on all the things going on at Herschel!

SPLICE KIT

For 2-1/16" hole spacing. Kit contains 2 straps along with the bolts & nuts. For 200, 900 Series headers.



Order No. C83-0755
List 26.70

SPLICE KIT

For 2" hole spacing. Kit contains 2 straps along with the bolts & nuts. Mowers & Mower Conditioners.

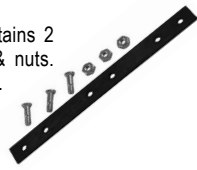

Order No. C83-0750
List 26.70

SPLICE KIT

For 600 series Herschel made sickles.

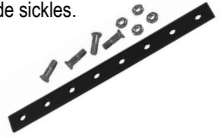

Order No. C83-1600
List 26.70

BOLTS FOR SPLICE KITS

Bolts and nuts for splice kits listed above. 12 each per package.



Order No. B55-0049D
List 11.36

JOHN DEERE 200 & 900 SERIES FLEX DRIVE HEADERS SPLICED SICKLES

Fits JOHN DEERE COMBINES WITH QUICK-TACH RIGID HEADER, 200 & 900 SERIES FLEX HEADER

If Head Required: Order #H15-0395 for Quick-Tach Rigid Headers.
Order #H15-0004 for 200 & 900 Series Flex Headers.

Note: For Sickles 16' or longer, use (1) S78-0005 Reinforcement Strap

WITH SUPER 7® CHROME SECTIONS

OEM #	Length	# Of Sections	Cut-Off Section	8' Segment	7.5' Head End	6' Segment	Order No.	List
SPLAH121076	13'	50	4	-	1	1	S35-2735	259.59
SPLAH121077	15'	60	2	1	1	-	S35-2736	299.84
SPLAH128721	16'	62	0	1	1	-	S35-2737	315.23
SPLAH121079	18'	70	8	-	1	2	S35-2738	364.36
SPLAH121081	20'	78	0	-	1	2	S35-2739	290.27
SPLAH121083	22'	86	0	1	1	1	S35-2740	387.01
SPLAH121085	24'	94	0	2	1	-	S35-2741	394.75
SPLAH121221	25'	100	2	-	1	3	S35-2742	345.97
SPLAH121087	30'	120	6	3	1	-	S35-2743	405.98

WITH TOP SERRATED 14 TOOTH CHROME SECTIONS

OEM #	Length	# Of Sections	Cut-Off Section	8' Segment	7.5' Head End	6' Segment	Order No.	List
SPLAH125754	20'	78	0	-	1	2	S35-2210	435.78
SPLAH125756	24'	94	0	2	1	-	S35-2212	479.98
SPLAH121221	25'	100	2	-	1	3	S35-2213	531.19
SPLAH121087	30'	120	6	3	1	-	S35-2214	619.08

WITH TOP SERRATED TIGER SHARK™ CHROME SECTIONS

OEM #	Length	# Of Sections	Cut-Off Section	8' Segment	7.5' Head End	6' Segment	Order No.	List
SPLAH125754	20'	78	0	-	1	2	S35-8920	459.65
SPLAH121083	22'	86	0	1	1	1	S35-8922	485.57
SPLAH121221	25'	100	2	-	1	3	S35-8925	547.94
SPLAH121087	30'	120	6	3	1	-	S35-8930	672.14

JOHN DEERE 600 SERIES FLEX DRAPER SINGLE DRIVE SPLICED SICKLES

Milled splice joints. Oval bolt holes

Segments sized to interchange with JD OE segments

Headless - Order heads separately

With chrome Super 7 or Tiger Shark sections

Ships via UPS

SUPER 7

Model	Description	All S35-5000 Head Seg	All S35-5003 Mid Seg	20 FT S35-4705 Tail Seg	25 FT S35-4706 Tail Seg	30 FT S35-4707 Tail Seg	35 FT S35-4708 Tail Seg	40 FT S35-4709 Tail Seg	Complete Sickle Order No.	List
620 SINGLE DR	JD 620	1	1	1					S35-4663	897.77
625 SINGLE DR	JD 625	1	1		1				S35-4664	1041.41
630 SINGLE DR	JD 630	1	2			1			S35-4665	1208.58
635 SINGLE DR	JD 635	1	2				1		S35-4666	1298.20
640 SINGLE DR	JD 640	1	3					1	S35-4667	1607.91

TIGER SHARK

Model	Description	All S35-8004 Head Seg	All S35-8003 Mid Seg	20 FT S35-8015 Tail Seg	25 FT S35-8016 Tail Seg	30 FT S35-8017 Tail Seg	35 FT S35-8018 Tail Seg	40 FT S35-8019 Tail Seg	Complete Sickle Order No.	List
620 SINGLE DR	JD 620	1	1	1					S35-8641	903.17
625 SINGLE DR	JD 625	1	1		1				S35-8642	1037.05
630 SINGLE DR	JD 630	1	2			1			S35-8643	1206.64
635 SINGLE DR	JD 635	1	2						S35-8644	1299.31
640 SINGLE DR	JD 640	1	3				1	1	S35-8645	1605.11

JD 600, 700 SERIES FLEX DRAPER DOUBLE DRIVE REPLACEMENT PARTS

Description	OEM #	Order No.	List
Splice Kit, 10-Hole, Tiger Shark™	AH205715TSRK	C83-1601JD	26.70
Splice Kit, 10-Hole, Super 7	AH205715	C83-1600JD	26.70
Head Strap	H156240	S78-0600	37.24
Head Bolts (15) 20MM, (10) 25MM	H158342, H158434	B55-0601D	54.62
Section Bolts 16MM	H158341	B55-0600D	47.97
Section Bolts. C/S For Overlap Sections	12 bolts/nuts	B55-0602D	9.33
Tiger Shark Overlap Kit. Includes sections, slide & hardware		S20-4012	76.49
Super 7 Overlap Kit. Includes sections, slide & hardware		S20-4011	76.49
Top Countersunk Super 7 Section For Overlap. Box of 10		S20-4540	78.95

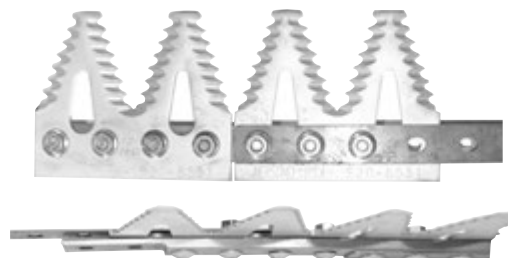

JOHN DEERE 600, 700 SERIES FLEX DRAPER DOUBLE DRIVE SPLICED SICKLES

Milled splice joints . Oval bolt holes
 Segments sized to interchange with JD OE segments
 Headless - Order heads separately
 With chrome Super 7 or Tiger Shark sections
 Ships via UPS

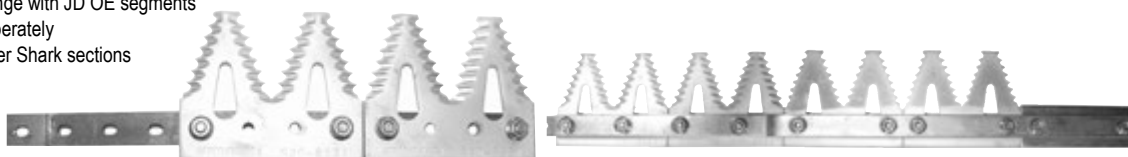

SUPER 7

Model	Description	All	All	20 FT	25 FT	30 FT	35 FT	40 FT	Order No.	List
		S35-5000 Head Seg	S35-5003 Mid Seg	S35-4705 Tail Seg	S35-4706 Tail Seg	S35-4707 Tail Seg	S35-4708 Tail Seg	S35-4709 Tail Seg		
600, 700 SERIES	20'	1	1	1					S35-4663	897.77
600, 700 SERIES	25'	1	1		1				S35-4664	1041.41
600, 700 SERIES	30'	1	2			1			S35-4665	1208.58
600, 700 SERIES	35'	1	2				1		S35-4666	1298.20
600, 700 SERIES	40'	1	3					1	S35-4667	1607.91

TIGER SHARK

Model	Description	All	All	20 FT	25 FT	30 FT	35 FT	40 FT	Order No.	List
		S35-8004 Head Seg	S35-8003 Mid Seg	S35-8015 Tail Seg	S35-8016 Tail Seg	S35-8017 Tail Seg	S35-8018 Tail Seg	S35-8019 Tail Seg		
600, 700 SERIES	20'	1	1	1					S35-8641	903.17
600, 700 SERIES	25'	1	1		1				S35-8642	1037.05
600, 700 SERIES	30'	1	2			1			S35-8643	1206.64
600, 700 SERIES	35'	1	2						S35-8644	1299.31
600, 700 SERIES	40'	1	3				1	1	S35-8645	1605.11



SICKLE HEAD

Fits JOHN DEERE Mowers 5, 8, 9, 11, 37, 38, 39, 39N. Replaces H28076.

Order No. List
H15-0282 90.31



SICKLE HEAD

Fits JOHN DEERE Mowers 47, 50, 250, 350, 450, 3700 w/Needle Bearing. Replaces AE48583.

Order No. List
H15-0335 123.20



SICKLE HEAD

Fits JOHN DEERE Mower Conditioner 1207 & 1209 (S/N 28500 & Up), 1217, 1219 Windrower 230,240,1380, 2280, 2320, 2420, 300 Twin Knife Header. Left hand with needle bearing. For bolted sickles ONLY. Replaces AE48125 and AE34328.

Order No. List
H15-0786 109.79



SICKLE HEAD

Fits JOHN DEERE 600F, 600R. Includes nylon collar. Replaces AH220051.

Order No. List
H15-0600 163.65



SICKLE HEAD

Fits JOHN DEERE Mower conditioner 300 Twin Knife Windrower, 2280, 2320 and 2420 300 Twin Knife Header. Right hand. For bolted sickles ONLY. Replaces AE48126

Order No. List
H15-0787 109.79

SICKLE HEAD

Fits JOHN DEERE 600 Flex Draper Double Drive. LH or RH. Replaces AH231842. Nylon insert.

Order No. List
H15-0602 104.64



SICKLE HEAD

Fits JOHN DEERE Combine 2000, 2002, 3300, 4400, 6600, 6601, 6602, 7700(Flex), 200 & 900 Series Headers TJ1996 & Newer. Replaces AH 89498, AH121075, KXE10217.

Order No. List
H15-0004 140.71



6" WEAR PLATE

Fits JOHN DEERE Mowers, Windrowers and Mower Conditioners. Replaces E47954.

Order No. List
P44-0650 4.05

SICKLE HEAD

Fits JOHN DEERE 600 Single Drive Head To Convert From 4" to 3". Replaces AH204938. Nylon insert.

Order No. List
H15-0601 112.56

HEAD BEARING KIT WITH SNAP RINGS

Fits JOHN DEERE Combine 200 & 900 Tiger Jaw (Fits H15-0952 Head). Replaces KP12A.

Order No. List
B15-0659B 36.64

HEAD REINFORCEMENT STRAP

For JD 600 series heads.

Order No. List
S78-0600 37.24



6" WEAR PLATE

Fits JOHN DEERE 200 & 900 series platforms. Replaces H153157.

Order No. List
P44-0655 3.76

HEAD REINFORCEMENT STRAP

Use (1) on 16" or longer, For Combine Sickles Except Tiger Jaw.

Order No. List
S78-0005 37.24

**HERSCHEL DISC MOWER KNIVES -
MADE IN THE USA**

- Manufactured in the U.S.A. to meet ISO 5718 standard on Knives for agricultural rotary disc mowers.
- Manufactured from high quality U.S.A. 10B38 (boron) steel.
- Edges are formed not ground to prevent edges from chipping & breakage.
- Entire knife is belt, not batch heat treated to a RC hardness of 45-52. Batch heat treating can cause knives on the inside of the batch to vary greatly in hardness compared to knives on the outside of the batch.
- Each knife is stamped with our name, date and lot number to allow us to trace the manufacturing process on each knife. This allows traceability of the steel back to the steel mill and the mills heat lot of the steel used in the knife.

DISC MOWER KNIVES

Fits JOHN DEERE 525, 530, 535, 625, 630, 635, 730, 735, 830, 835, 910, 915, 916, 920, 925, 926, 930, 935, 936, 945, 946, 955, 956, 990, 994, 995, 1340, 1350, 1360, 1460, 1470.

Length: 4.21"	Degree of Twist: 13	Hole Diameter: .72
Width: 1.78	Thickness: 0.169	Center Of Hole To Back Edge: .80

OEM Number	Style	Shape	Bolt Order No	6 Blades Order No	List	25 Blades Order No	List
E80208	4	RH Twisted	B55-0344D	B45-6568D	15.03	B45-6568	59.94
E80206	4	LH Twisted	B55-0344D	B45-6569D	15.03	B45-6569	59.94



DISC MOWER KNIVES

Fits JOHN DEERE 1314, 1315.

Length: 3.66"	Degree of Twist: 13	Hole Diameter: .64
Width: 1.60	Thickness: 0.116	Center Of Hole To Back Edge: .80

OEM Number	Style	Shape	Bolt Order No	6 Blades Order No	List	25 Blades Order No	List
CC19336	4	LH Twisted	B55-0358D	B45-6996D	15.56	B45-6996	46.70
CC19333	4	RH Twisted	B55-0358D	B45-6997D	15.56	B45-6997	54.42



DISC MOWER KNIVES

Fits JOHN DEERE 1320, 1326, 1327, 240, 260

Length: 3.75"	Degree of Twist: 13	Hole Diameter: .64
Width: 1.78	Thickness: 0.140	Center Of Hole To Back Edge: .75

OEM Number	Style	Shape	Bolt Order No	6 Blades Order No	List	25 Blades Order No	List
CC20500, CC44005	4	LH Twisted	B55-0358D	B45-6122D	14.21	B45-6122	60.19
CC20501, CC44006	4	RH Twisted	B55-0358D	B45-6123D	14.21	B45-6123	60.19



DISC MOWER KNIVES

Fits JOHN DEERE 1320, 1326, 1327, 265, 270, 275, 285.

Length: 4.72"	Degree of Twist: 13	Hole Diameter: .73
Width: 1.79	Thickness: 0.170	Center Of Hole To Back Edge: .78

OEM Number	Style	Shape	Bolt Order No	6 Blades Order No	List	25 Blades Order No	List
CC21780	4	LH Twisted	B55-0358D	B45-6565D	15.91	B45-6565	62.07
CC21781	4	RH Twisted	B55-0358D	B45-6566D	15.91	B45-6566	62.07



FORGED STEEL GUARD

Fits JOHN DEERE Mower Conditioner & Windrowers 300, 300A prior to sn 943000. Mower Conditioners 1217, 1218 sn 71001 & later; 1600, 4890, 4895 using 890, 895, 896 Auger Platform. Replaces HA222H, FS 96-DH, E72428, H113571. Double Heat Treated.



Order No List
G81-0147 16.39

FORGED STEEL GUARD

Fits JOHN DEERE Mowers 37, 389, 39, 250, 350, 450. M/C 480, 483, 485. Windrowers 215, 215A, 780, 800, 880. Platform Augers 18, 19, 183, 188, 220 & 230 prior to s/n 425000. Draper platforms 78, 88, 120, 130, 135. Replaces HA220, FS82-2, E48093, E52667, E82559 Up To 1978



Order No List
G81-0185 19.25

FORGED STEEL GUARD

Fits JOHN DEERE Windrowers 580, 590; 140, 160 Augers. Replaces HA215DH, FS81DH. Double heat treated.



Order No List
G81-0155 15.00
G81-0098 - Double Heat Treat 17.43

FORGED STEEL GUARD

Fits JOHN DEERE Model 580, 590, 140 Auger. 160 Draper. Replaces HA235, FS73-2, W30341.



Order No List
G81-0070 19.03

FORGED STEEL GUARD

Fits JOHN DEERE Quick Tach 200, 900 Series. Replaces HA240S and H145791.



Order No List
G81-0021 19.31

FORGED STEEL GUARD

Fits JOHN DEERE Mower Conditioners - 710, 720, 820, 830, 1600A. Auger Platforms - 300A s/n 943001 and later; 890. Replaces E81300 and E88909.



Order No List
G81-0223 26.05

FORGED STEEL GUARD

Fits JOHN DEERE 600F, 600FD, 700FD. Replaces H229537. Double Heat Treat. 610DH. Long-Short-Long.



Order No List
G81-0537 19.58

FORGED STEEL GUARD

Fits JOHN DEERE 600F, 600FD, 700FD. Replaces H229538. Double Heat Treat. 615DH. Short-Long-Short.



Order No List
G81-0538 19.58

FORGED STEEL GUARD

Fits JOHN DEERE 600 Series Rigid & Draper Heads. 900 Series Draper Heads. Replaces HA635, H213405. Long-Short-Long.

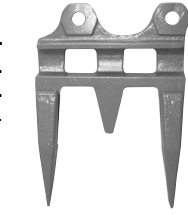

Order No List
G81-0396 20.58

FORGED STEEL GUARD

Fits JOHN DEERE 600 Series Rigid & Draper Heads. 900 Series Draper Heads. Replaces HA630, H213408. Short-Long-Short.



Order No List
G81-0397 20.89

SINGLE POINT END GUARD

Fits JOHN DEERE 600D, 600FD, 700D, 700FD, 900D. Replaces H228526.



Order No List
G81-0541 16.38

MIDDLE OVERLAP GUARD, LEFT

Fits JOHN DEERE 600FD, 700FD Double Drives (1 used). Replaces HXE18172.



Order No List
G81-0543 26.65

MIDDLE OVERLAP GUARD, RIGHT

Fits JOHN DEERE 600FD, 700FD Double Drives (1 used). Replaces HXE19625.



Order No List
G81-0542 29.07

CENTER HOLD DOWN

Double Drive (2 used). Fits JOHN DEERE 600D, 600F, 600FD, 600R, 700D, 700F, 900D. Replaces AH226928.



Order No List
G81-0540 23.65

FORGED STEEL GUARD

Fits JOHN DEERE combines. Replaces HA240A, FC 62-2A, H145791, H75386, H61954H.



Order No List
G81-0191 13.40

FORGED STEEL GUARD

Fits JOHN DEERE 600, 700 Series Flex Heads. Replaces HA610, H213507, H20547, H213400. Long-Short-Long.



Order No List
G81-0398 20.86

FORGED STEEL GUARD

Fits JOHN DEERE 600, 700 Series Flex Heads. Replaces HA615, H205448, H213398. Short-Long-Short.



Order No List
G81-0399 20.86

FORGED STEEL GUARD

Fits JOHN DEERE combines. Replaces HA340, FC 62-3G, H25603, H153855.



Order No List
G81-0026 31.25

FORGED STEEL GUARDS

Fits all TIGER JAWS.



Replaces	Description	Order No	List
TJ44-4A	4 Prong	G81-0581	24.17

MALLEABLE GUARDS

Fits JOHN DEERE MOWERS.



G81-0803

Replaces	Description	Order No	List
DM700, AZ 3441H, AZ2131H	Center Guard	G81-0803	8.24

CONICAL GUARD BOLT NUT

Package includes 5, 7/16" nuts.



Order No List
N83-0593D 7.72

GUARD PLATE

Fits JOHN DEERE Mowers with AZ3441 guard. Replaces Z5110H. 10/box



Order No List
P44-0646 19.36

- PATENTED 2 PIECE DESIGN.
- SAVE MONEY!
REPLACE ONLY THE TINE.



HERSCHEL 6" 2-PIECE POLY TINES FOR PIPE REELS

Fits JOHN DEERE 900 F & R series s/n 685101 an up, 600 series. 1/2" diameter nub.

Description	Pkg. Qty.	Order No.	List
Tine & Clamp	100/Box	T16-0740	233.22
Tine & Clamp	10/Box	T16-0745	25.00
Tine ONLY	100/Box	T16-0750	150.24



BALER TOOTH

For JOHN DEERE Balers 14T, 24T, 214T, 214W. Replaces 276SE.

Order No.	List
T16-0022	3.94



BALER TOOTH

For JOHN DEERE Balers 327, 336, 346, 337, 347, 367. Replaces E41833.

Order No.	List
T16-0024	3.39



BALER TOOTH

For JOHN DEERE Balers 410, 430, 500, 510, 550. Replaces E61295, E67036.

Order No.	List
T16-0025	3.03



COMBINE FLEX TINE

For Front side of wood bats. Replaces N66A. 1 mounts to front of bat. 100 per box.

Order No.	List
T16-0183	225.49



COMBINE FLEX TINE

For Rear side of tear drop bats. Replaces N67A. 1 mounts to rear of bat. 100 per box.

Order No.	List
T16-0767	190.20



COMBINE 2 PIECE M/L REEL TINE

For Most Pipe Style Reels with 4" bat. Replaces 782551, 1989438C1, AH136689, AH153175. Includes clamps. 100 per box. 3/8" diameter nub.

Order No.	List
T16-0720	251.62



COMBINE 2 PIECE M/L REEL TINE

For Most Pipe Style Reels with 4" bat. Replaces 782226, 1989438C1, AH136689, AH153175. Includes clamps. 10 per bag. 3/8" diameter nub.

Order No.	List
T16-0715	23.22



COMBINE M/L REEL TINE

For T16-0715 and T16-0720. No clamps. Replaces HA100MLT. Tine only, no clamps. 100 per box. 3/8" diameter nub.

Order No.	List
T16-0725	147.75



COMBINE PICKUP REEL

For JOHN DEERE 200 Series platform w/Hume reel. Replaces H1611. Steel. 100 per box.

Order No.	List
T16-0124	1.90



RAKE TOOTH

For JOHN DEERE Rakes 567. Replaces E 35277.

Order No.	List
T16-0315	6.40

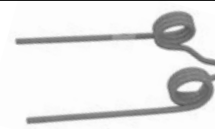

RAKE TOOTH

For JOHN DEERE Mower Conditioners 1207, 1209, 1217, 1219, 1380 & AE68906 After SN 425000. Replaces E10711, AE68906.

Order No.	List
T16-0332	4.53



RAKE TOOTH

For JOHN DEERE Rakes 553, 594, 594 LW Quick Detach. Replaces 186SE, 175SE. Spring.

Order No.	List
T16-0320	4.85



RAKE TOOTH

For JOHN DEERE Rakes 14, 596, 597, 714 Quick Detach. Replaces 194SE.

Order No.	List
T16-0325	4.45



RUBBER MOUNT RAKE TOOTH

For JOHN DEERE Rakes 640, 650, 660, 670, 672, 662, 652, 896A. Replaces 1/4 x 3/4 LPK, RMT-1, AE47389. Right hand.

Order No.	List
T16-0182	3.15



RUBBER MOUNT RAKE TOOTH

For JOHN DEERE Twin Rake 700, 705. Replaces EF2888001, AE56204. Right/Left hand.

Order No.	List
T16-0185	5.07



RUBBER MOUNT RAKE TOOTH

For JOHN DEERE Rakes 640, 650, 660, 670, 672, 662, 652, 896A. Replaces AE47389. Left hand. Torsion

Order No.	List
T16-0188	6.04



RAKE/BALER TOOTH

For JOHN DEERE Rakes 851, 894, 350, 858 & 896, 350. Balers 24T, 216T. Replaces 257SE.

Order No.	List
T16-0330	2.78

RAKE WHEELS

Heavy Duty, .276" (7mm).
Fits Tonutti/National/Walton,
John Deere/Frontier, Vermeer,
Kuhn, Miller Pro/Arts Way, Gehl.
Painted Black

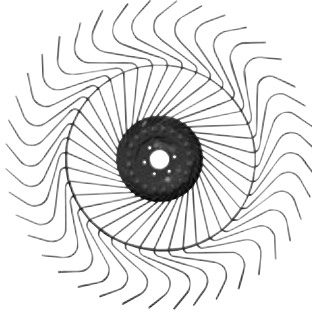

Description	Order No	List
Right Hand. P20BG003	W16-0805	180.08
Left Hand. P20BG004	W16-0806	180.08

Replacement Tine: T16-0497.

RAKE WHEELS

Heavy Duty, .276" (7mm).
Fits Tonutti/National/Walton,
John Deere/Frontier, Vermeer,
Kuhn, Miller Pro/Arts Way, Gehl.
Painted Creme

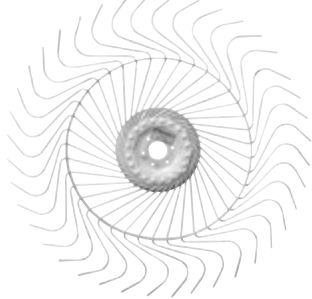

Description	Order No	List
Right Hand. P20BG003	W16-0811	180.08
Left Hand. P20BG004	W16-0812	180.08

Replacement Tine: T16-0497.

PLASTIC BEARING KIT

Includes 12 bearing halves, 6 bolts,
and 6 nuts.



Application: Pipe Reels with Plastic
Tines used on JOHN DEERE 900
series S/N 645300 an up.

Order No.	List
B15-0925	31.07

GATHERER BELT CHAIN (2 PER ROW)

Replaces AH101172. For 50A Series Row Crop
Header and 2 Row Forage Harvesters.

Order No	List
B22-0060	270.82

GATHERING CHAIN

DRIVE SPROCKET

For JOHN DEERE 40 Series to S/N
466450. Replaces AN102448, Sealed.



Order No	List
S62-0741	34.31

BALER PARTS



LOWER DRIVE ROLLER SPROCKET

Round Balers 330, 335, 375, 385, 430, 435, 449, 459, 530, 535, 540, 545, 550, 559, 569. Replaces AE39652.

20/40 Tooth, 60 Chain, 1.504" Bore

Order No.	List
HAE39652	126.60



STARTER ROLLER SPROCKET

Round Balers 446, 447, 449, 456, 457, 459, 466, 467, 468, 546, 547, 556, 557, 559, 566, 567, 568, 569. Replaces AE54301, AFH205816.

24 Tooth, 60 Chain, 1.504" Bore

Order No.	List
HAE54301	63.20



LOWER DRIVE ROLLER SPROCKET

Round Balers 446, 447, 449, 456, 457, 459, 466, 467, 468, 546, 547, 556, 557, 559, 566, 567, 568. Replaces AE54302, AFH205819.

40/24 Tooth, 60 Chain, 1.504" Bore

Order No.	List
HAE54302	126.42



DRIVE SPROCKET FOR STANDARD PICKUP

Round Balers 447, 448, 449, 457, 458, 458S, 459, 467, 468, 468S, 469, 547, 567, 557, 558, 559, 568, 569. Replaces AE58632, AFH205822.

40 Tooth, 50 Chain, 1.253" Bore

Order No.	List
HAE58632	86.04



SLIP CLUTCH SPROCKET FOR STANDARD PICKUP

Round Balers 447, 448, 457, 458, 458s, 467, 468, 468s, 547, 567, 557, 558, 568. Replaces E96714, E131608.

38 Tooth, 50 Chain, 2.625" Bore, 4 Bolt, 3.307" Bolt Circle

Order No.	List
HE96714	38.24



UPPER DRIVE ROLLER SPROCKET #80

Round Balers 458, 468, 468s, 558, 568. Replaces AE74596.

30 Tooth, 80 Chain

Order No.	List
HAE74596	109.29

1-YEAR WARRANTY ON ALL ITEMS!

BALER PARTS



MAIN DRIVE SPROCKET FROM GEAR BOX #80

Round Balers 458, 468, 468s, 558, 568. Replaces AE74597.

13/13 Tooth, 80 Chain

Order No.	List
HAE74597	82.20

HEADER DRIVE SPROCKET #50

Round Balers 447, 448, 457, 458, 467, 468, 468s, 540, 545, 547, 550, 557, 567, 568. Replaces AE57757.

19 Tooth, 50 Chain, 1.253" Bore

Order No.	List
HAE57757	51.91



CAM FOLLOWER BEARING FOR PICKUP REEL

Round Balers 330, 335, 375, 385, 410, 430, 435, 446, 447, 448, 449, 456, 457, 458, 459, 466, 467, 468, 468s, 510, 530, 535, 540, 545, 546, 547, 550, 556, 557, 559, 566, 567, 568, 569. Replaces AE46215, AFH2040000.

.05" Bore

Order No.	List
HAE46215	19.62

STARTER ROLL, LOWER GATE ROLLER BEARING

Round Balers 335, 375, 385, 435, 446, 449, 456, 459, 466, 467, 469, 535, 546, 556, 559, 566, 567, 569. Replaces AE40895.

1-1/2" Hex. 3.3456" OD

Order No.	List
HAE4089	40.82



TOP IDLER & DRIVE ROLLER BEARING

Round Balers 430, 435, 456, 466, 467, 530, 535, 547, 556, 557, 567. Replaces AE74652, AR54574, AFH206196, AE45208, AE54574, AE45038.

1-1/2" Hex. 3.5433" OD w/Cast 4-Bolt Flange

Order No.	List
HAE74652	97.98

IDLER, REAR GATE W/O NET WRAP, BELT STAGGERING & ARM ROLLER BEARING

Round Balers 335, 375, 430, 435, 446, 447, 449, 456, 457, 458, 458S, 459, 466, 467, 468, 468S, 469, 530, 535, 546, 547, 557, 558, 559, 566, 567, 568, 569. Replaces AE46606.

1-1/4" Hex. 3.1496" OD

Order No.	List
HAE46606	21.55

PICKUP FRAME SUPPORT BEARING

Round Balers 385, 430, 435, 447, 456, 457, 458, 468, 468S, 530, 535, 567, 568. Replaces JD9313.

1.0" Hex. 2.4409" OD

Order No.	List
HJD9313	13.51

STARTER & PICKUP DRIVE ROLLER

Round Balers 3335, 375, 430, 435, 446, 447, 449, 456, 457, 458, 458S, 459, 466, 467, 468, 468S, 469, 530, 535, 546, 547, 557, 558, 559, 566, 567, 568, 569. Replaces JD8338.

1.0" Hex. 2.44" OD

Order No.	List
HJD9338	19.84

1-YEAR WARRANTY ON ALL ITEMS!

HERSCHEL sections are made in the USA from high quality boron steel. Heat-treated for long life. Sections are extra heavy (.116") and chrome unless stated otherwise.

SECTION TYPES	
7TS = Super 7® Top Serrated	TT = Tiger Tooth
SM = Smooth	TJ = Tiger Jaw
US = Under Serrated - 14 Tooth	SRK = Tiger Shark™
TS = Top Serrated - 14 Tooth	



SECTION - XHSM
 Bottom countersunk. Section is 3" x 3-1/4". Use 5/8 CS Rivet. Sold 10 sections per pack.

Replaces		
Number	Order No	List
49152	S20-1152	25.33

HERSCHEL sections are made in the USA from high quality boron steel. Heat-treated for long life. Sections are extra heavy (.116") and chrome unless stated otherwise.

SECTION TYPES

7TS = Super 7® Top Serrated TT = Tiger Tooth
 SM = Smooth TJ = Tiger Jaw
 US = Under Serrated - 14 Tooth SRK = Tiger Shark™
 TS = Top Serrated - 14 Tooth



SECTION - XHSM
 Fits KOSCH Mowers. Section is 3" x 3-1/4". Use 9/16 OH Rivet. Sold 10 sections per pack.

Replaces Number	Order No	List
K164	S20-1145	19.48



SECTION - XHUSCR
 Fits KOSCH Mowers. Section is 3" x 3-1/4". Use 9/16 OH Rivet. Sold 10 sections per pack.

Replaces Number	Order No	List
K165CR	S20-6339	20.60

HOLD DOWN CLIPS ADJUSTABLE



C45-0006 C45-0007

Fits most KOSCH Mowers and Conditioners. Cast.

Style	Order No.	List
Low Arch	C45-0006	37.80
High Arch	C45-0007	37.80

Fits most KOSCH Combines, Mowers and Windrowers except Versatile, Hart-Carter & Love. Stamped



Style	Order No.	List
Low Arch	C45-0040	9.05



SECTION - XHUS
 Fits KOSCH Mowers. Section is 3" x 3-1/4". Use 9/16 OH Rivet. Sold 10 sections per pack.

Replaces Number	Order No	List
K165	S20-5107	16.38



SECTION - XHTS
 Fits KOSCH Mowers. Section is 3" x 3-1/4". Use 9/16 OH Rivet. Sold 10 sections per pack.

Replaces Number	Order No	List
K164CR	S20-3276	16.39

BOLTED SICKLES - XHUS SECTIONS

Section OEM# K165.

OEM #	Length	# of Sections	Head OEM#	Order No	List
KA436DS	9'			S35-1330*	131.81

*Special order item - Minimum quantity may be required.



WEAR PLATE
 Center guard. Fits KOSCH Mowers. Replaces K162.

Order No.	List
P44-0417	3.00

HOLD DOWN CLIP NON-ADJUSTABLE



Fits KOSCH Mowers and Conditioners. Steel.

Style	Order No.	List
High Arch	C45-0693	7.45

BOLTED SICKLE - XH7TS SECTIONS - HEADLESS

Fits KOSCH MOWERS.

Length	Order No	List
7'	S35-1038	124.53
9'	S35-1039	146.18





Get Online With Herschel Parts!

HERSCHELPARTS.com

MALLEABLE GUARD

Center guard. Fits 7/16" Bars. Fits KOSCH Mowers. Replaces MC2041Z, K167.

Order No	List
G81-0830	14.85

RIVETED SICKLES

Head OEM# K066A.

OEM #	Length	# of Sections	Head OEM#	Order No	List
KA192	7'	28 - XHUS	K 165	S35-3329	166.90
KA1790	9'	36 - XHUS	K 165	S35-3333	214.21
KA1790	9'	36 - XHTS	826720C2	S35-3018*	252.91

*Special order item - Minimum quantity may be required.

GUARD BOLT

#3 bolt. Replaces 592722R1, M805X. 50 bolts/nuts per package. 7/16" x 1-1/2".

Order No	List
B55-0260	33.96



GUARD BOLT

#3 bolt. Replaces K256. 50 bolts/nuts per package. 7/16" x 1-3/4".

Order No	List
B55-0265	28.02



1-YEAR WARRANTY ON ALL ITEMS!

HERSCHEL sections are made in the USA from high quality boron steel. Heat-treated for long life. Sections are extra heavy (.116") and chrome unless stated otherwise.

All MACDON sections have 2-1/8" hole spacing.

SECTION TYPES

- 7TS = Super 7[®] Top Serrated
- SM = Smooth
- US = Under Serrated - 14 Tooth
- TS = Top Serrated - 14 Tooth
- TT = Tiger Tooth
- TJ = Tiger Jaw
- SRK = Tiger Shark™



SECTIONS
Fits MACDON Windrower 1000, 2000, 3000 & 7000. Section is 3" x 3-1/4". Uses 5/8 OH rivet. Sold 10 sections per pack.

OEM #	Description	Order No	List
16671	XHUS	S20-5743	22.24



SECTION CLIP
Replaces 87458207. Used on D50, D60, FD70 & FD75 Headers. Bag of 20.

Order No	List
C45-0050	12.55

WHY TRY TIGER SHARK™ SECTIONS?

1. Serrated teeth allow more cutting surface.
2. They last longer, cut faster.
3. Cuts equally well in soybeans, alfalfa, grass hay, wheat, etc.

Customer Testimonial:

"I cut over 1000 acres of soybeans with the same *Herschel Tiger Shark™* sections. They stayed sharper longer and lasted longer than any section I have used." - Roger Woodruff, Warren Co. Iowa

OVERLAP SECTIONS
Fits all MACDON Models. Overlap area. Low shoulder. Section is 3" x 3-7/32". Top countersunk holes. Uses 5/8 CS rivet. Sold 10 sections per pack.

OEM #	Description	Order No	List
129319	Tiger Shark™	S20-8399	35.09
34390CR-CS	XH7TSCR-CS	S20-4399	32.06
34390CRTCS	XH7TSCR	S20-4390	31.00



OVERLAP SECTIONS
Fits all MACDON Models. Overlap area. Low shoulder. Section is 3" x 3-7/32". Bottom countersunk holes. Uses 5/8 CS rivet. Sold 10 sections per pack.

OEM #	Description	Order No	List
34390CR-CS	Tiger Shark™	S20-8427	35.09
34390CR-CS	XH7TSCR	S20-4427	31.67

SECTION OVERLAP KITS
Fits MACDON Mowers and Combine heads with double drive sickles. Kit includes 4 Top countersunk sections, 3 bottom countersunk sections and countersunk bolts and nuts.

Description	Order No	List
Tiger Shark™	S20-8009	39.18
XH7TSCR	S20-4009	39.18
XHTSCR	S20-4014	39.18



SECTIONS
Fits MACDON Mowers and conditioners, 912, 922, 933, 960, 962, 963, 972, 973, 974, 4000, D50, D60, FD70, FD75 Headers. Section is 3" x 3-1/4". Uses 5/8 OH rivet. Sold 10 sections per pack. The *Tiger Shark™* section can be used in place of the sections listed below.

OEM #	Description	Order No	List
34390	Tiger Shark™ - Chrome	S20-8398	19.51
34390	Tiger Shark™ - Black	S20-9398	17.63
34390	XH7TSCR	S20-4398	19.51
34390	XHTSCR	S20-4170	26.18
34390	XHTS	S20-3283	20.00

UNIVERSAL END SECTIONS
HERSCHEL "End Sections" are made of one-piece high carbon, heat-treated steel for rugged use. They are punched with an oblong hole to virtually fit any standard cutterbar mower in use today. To install our "End Section", simply take off the last section on the shoe end of your sickle assembly and replace it with an "End Section". The change-over takes only a couple of minutes to complete and you will notice a big difference in time saved from unclogging your mower. We recommend using an R36-0523D oval head rivets or B55-0065D Bolts.

Description	Order No	List
XH7TSCR (RH) 10/Box	S20-4403	59.59
XH7TSCR (RH) 2/SP	S20-4403D	16.31
Tiger Shark™ (RH) 10/Box	S20-8403	64.31
Tiger Shark™ (RH) 2/SP	S20-8403D	11.44
XH7TSCR (LH) 10/Box	S20-4445	63.81
XH7TSCR (LH) 2/SP	S20-4445D	11.26
Tiger Shark™ (LH) 10/Box	S20-8445	64.31
Tiger Shark™ (LH) 2/SP	S20-8445D	18.67
XHTS CR (RH) 10/Box	S20-4210	59.59
XHTS CR (RH) 2/SP	S20-4210D	16.31
XHTSCR (LH) 10/Box	S20-4211	59.59
XHTSCR (LH) 2/SP	S20-4211D	16.31
XHUSCR (RH) 10/Box	S20-6640	63.12
XHUSCR (RH) 2/SP	S20-6640D	16.31

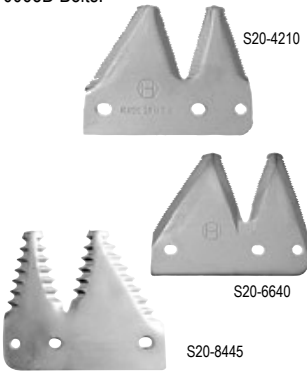

SECTION BOLTS

- Quick and easy section changes are possible with bolts.
- No more cutting, chiseling, or grinding - simply unbolt the section, replace and tighten bolts.
- Bolts will not turn in Knife Back and are reusable. They will last thru the life of several sections.
- Bolts may be replaced easily if accidentally damaged or broken.
- No special tools are needed to change sections, only a 7/16 wrench or socket.
- Bolt and nuts hold better than rivets and they have a greater clamp load than rivets.
- Special lock nuts will not vibrate loose.

Description	Application	Pkg.	Qty. Mst Ctn.	Order No	List
Section Bolt w/nut	Universal - Replaces 9/16 & 5/8 OH Rivets	50	300	B55-0065D	12.28
Head Bolt w/nut	Universal - Replaces 1-1/2 & 1-1/16 OH Rivets	15	90	B55-0085D	7.31
Head Bolt w/nut	Universal - Replaces 1-1/2 OH Rivets	12	72	B55-0095D	7.51
Section Bolt w/nut	Universal Bolts for 10' Sickle w/Head Bolts (80-B55-0065D, 5-B55-0085D, 5-B55-0095)	90	Each	B55-0500D	28.42
Overlap Bolt w/Low Profile Nut*	Double Drive Sickles, replaces 1/2 CS rivets 60° Head	10	60	B55-0059D	9.40
Nut	Universal-Used on all the above bolts except B55-0050D	20	120	N83-0289D	6.70

* Use with Allen Wrench



Get Online With Herschel Parts!

HERSCHELPARTS.com

You can shop 24 hours a day. 7 Days A Week!

We are also on Facebook and Twitter! Check out our pages today and stay up-to-date on all the things going on at Herschel!

FORGED STEEL GUARD

Fits MACDON 3000, 3020, 4000, 5000, 5010, 5020, 7000, 8000, 9000 series windrowers and mower conditioners' 960, 962, 963, 972, 973, 974, D50, D60, FD70 Drapers; 910, 912, 920, 922, 930, 942, A30S, A30D, A40D Auger Headers. Replaces FS73-2, BU235, 8420, HA235, K84205, K16716-1. **No wear bar.**

<u>Order No</u>	<u>List</u>
G81-0070	19.03



FORGED STEEL GUARD

Fits MACDON 3000, 3020, 4000, 5000, 5010, 5020, 7000, 8000, 9000 series windrowers and mower conditioners' 960, 962, 963, 972, 973, 974, D50, D60, FD70 Drapers; 910, 912, 920, 922, 930, 942, A30S, A30D, A40D Auger Headers. Replaces HA250, FS86-2, 34359. **Stub Guard.**

<u>Order No</u>	<u>List</u>
G81-0120	13.40



FORGED STEEL GUARD

Fits MACDON 3000, 3020, 4000, 5000, 5010, 5020, 7000, 8000, 9000 series windrowers and mower conditioners' 960, 962, 963, 972, 973, 974, D50, D60, FD70, FD75 Drapers; 910, 912, 920, 922, 930, 942, A30S, A30D, A40D Auger Headers. Replaces BU215D-HC, 28013, 124338. **Double heat treated. Center guard.**

<u>Order No</u>	<u>List</u>
G81-0093	25.55



FORGED STEEL GUARD

Fits MACDON 3000, 3020, 4000, 5000, 5010, 5020, 7000, 8000, 9000 series windrowers and mower conditioners' 960, 962, 963, 972, 973, 974, D50, D60, FD70 Drapers; 910, 912, 920, 922, 930, 942, A30S, A30D, A40D Auger Headers. Replaces HA215M, 23064, 28013, 118344, 118484. **Short.**

<u>Order No</u>	<u>List</u>
G81-0097	17.43



FORGED STEEL GUARD

Fits MACDON 972, D50, D60, D65, FD70, FD75. Left hand overlap guard for double drive heads. 1 used per machine. Replaces 118301.



<u>Order No</u>	<u>List</u>
G81-0092	18.20

FORGED STEEL GUARD

Fits MACDON 972, D50, D60, D65, FD70, FD75. Right hand overlap guard for double drive heads. 1 used per machine. Replaces 118302.



<u>Order No</u>	<u>List</u>
G81-0096	18.20

FORGED STEEL GUARD

Fits MACDON 972, D50, D60, D65, FD70, FD75. Guard for drive head areas. 2-6 used per machine. Replaces 118345.



<u>Order No</u>	<u>List</u>
G81-0094	19.14



WEAR PLATE - 6"
Fits MACDON Windrowers.
Replaces 7382.

Order No.	List
P44-0417	3.00



SICKLE HEAD - LH
Fits MACDON 7000 Auger, 5000, 910, 920, 930, 940. Replaces 34388.

Order No.	List
H15-0132	78.43

SICKLE HEADS

FD Series and CNH 2152, 2162 Head

Description	OEM #	Order No.	List
LH Head	132896	H15-0075L	139.44
RH Head	132897	H15-0075R	139.44

1-YEAR WARRANTY ON ALL ITEMS!

BOLTED SICKLES - XHTSCR - HEADLESS

Fits MACDON 7000 WINDROWERS WITH AUGER HEAD SINGLE DRIVE. JD 2360.

Section OEM# 34390CR.

OEM #	Length	# of Sections	Order No	List
BN34393CR	14'	57	S35-2028	347.55

BOLTED SICKLES - XHTSCR - HEADLESS

Fits MACDON 7000 WINDROWERS WITH AUGER HEAD SINGLE DRIVE. JD 2360.

Section OEM# 34390CR.

OEM #	Length	# of Sections	Order No	List
BN33718CR	7' RH	29	S35-2032	246.37
BN33719CR	8' RH	33	S35-2034	293.87
BN33716CR	8' LH	33	S35-2033	293.87

BOLTED SICKLES - XH7TSCR - HEADLESS

Section OEM# SS34390CR.

Replaces	Size	Application	Order No	List
36931	9'	4000 9' Single Drive	S35-2257	240.44
34181	12'	5020, 5000, 7000 Auger Header, 12' Single Drive, 912	S35-2258	339.55
34182	14'	5020, 5000, 7000 Auger Header, 14' Single Drive, 912	S35-2259	396.24
34183	16'	5020, 5000, 7000 Auger Header, 16' Single Drive, 912	S35-2260	336.75
33704	18'	7000, 18' Draper Header, Single Drive	S35-2262	464.45
33705	21'	7000, 21' Draper Header, Sgl. Drive, Also Used on 25' & 30' Models	S35-2253	461.04
43076	4' Ext.	7000, 25' Draper Header, Sgl. Drive, Sickle Extn., Use With S35-2253	S35-2254	239.23
43077	9' Ext.	7000, 30' Draper Header, Sgl. Drive, Sickle Extn., Use With S35-2253	S35-2255	345.71
34181	12'	910,912, 920, 922, 930, 12' Single Drive	S35-2258	339.55
34182	14'	910,912, 920, 922, 930, 14' Single Drive	S35-2259	396.24
34183	16'	910,912, 920, 922, 930, 16' Single Drive	S35-2260	336.75
155063	7'RH	910,920,922, 930, 14' 7000 Auger Header, Dbl. Drive w/Std. Guards	S35-2241	155.37
155062	7'LH	910,920,922, 930, 14' 7000 Auger Header, Dbl. Drive w/Std. Guards	S35-2240	156.53
155065	8'RH	910,920,922, 930, 16' 7000 Auger Header, Dbl. Drive w/Std. Guards	S35-2243	170.84
155063	8'LH	910,920,922, 930, 16' 7000 Auger Header, Dbl. Drive w/Std. Guards	S35-2242	193.05
155069	7' LH	932 14' Dbl. Drive, Auger Header, 922, 933	S35-2281	267.18
155064	7' RH	932 14' Dbl. Drive, Auger Header, 922, 933	S35-2282	267.18
38634	18'	940 18' Single Drive	S35-2249	335.26
34211	7'LH	942 15' Double Drive	S35-2240	156.53
155067	9'RH	942 18' Double Drive	S35-2252	244.88
155066	9'LH	942 18' Double Drive	S35-2251	246.51
43074	21'	960, 21', Also used on 25',30' & 36' Models, 962, 963, 3000, 3020	S35-2253	461.04
43076	4' Ext.	960 25' Sickle Extension, Use w/ S35-2253, 962, 963, 3000, 3020	S35-2254	239.23
43077	9' Ext.	960 30' Sickle Extension, Use w/ S35-2253, 962, 963, 3000, 3020	S35-2255	345.71
43078	15' Ext.	960 36' Sickle Extension, Use w/ s35-2253, 962, 963, 3000, 3020	S35-2256	290.04
118443	10.5' LH	972 21' Dbl. Drive	S35-2350	354.27
118395	10.5 RH	972 21' Dbl. Drive	S35-2351	354.27
118441	15' LH	972 30' Dbl. Drive	S35-2357	197.98
118448	15' RH	972 30' Dbl. Drive	S35-2358	197.98
124926	16' RH	D50, D6, Rigid Draper Head. Same as IH 2142 & 2152	S35-2120	218.96
124923	16' LH	FD70 Flex Draper Head. Same as IH 2162. A40D Auger Head	S35-2121	218.96

S35-2259



S35-2262



S35-2243



S35-2242



S35-2350



S35-2120

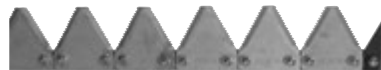

S35-2121



SICKLE SPLICE KIT

For Spliced Sickles. 2-1/8" c-c holes. Includes Splice Bar, Bolts, & Nuts. Bolt kit includes 10 csk bolts and nuts.



Replaces	Order No	List
43206	C83-0401	36.24
Bolt Kit	B55-0049D	11.36

RIVETED SICKLES - XHTSCR - HEADLESS

Fits MACDON WINDROWERS, 2000, HYDRO-MAC.

Head OEM# 20388.

OEM #	Length	# of Sections	Order No	List
18132	25'	100	S35-4928	588.05

Our Agricultural Background - Cutting Parts

Founded in 1887, by two brothers, Paul E and H. Robert Herschel. R. Herschel Manufacturing quickly became a leader in the sickle section industry.

For more than 130 years HERSCHEL has been an innovator in the cutting parts industry and introduced the chrome plated section (1950), Tiger Jaw® (1981) and Tiger Jaw 2000® (1997) combine conversion kits, Super 7® sections (1992) and most recently the Tiger Shark™ section (2016). Cutting parts designed to provide the agricultural industry with a high quality product at an exceptional value. We are proud to still make our popular cutting products at our factory in Indianola, IA.

RIVETED SICKLES

Fits MACDON WINDROWERS, 2000, HYDRO-MAC.

Head OEM# 20388.

OEM #	Length	# of Sections	Section#	Order No	List
22258	15'	XHTSCR - 59	22268CR	S35-4737	490.85



MACDON POLY REEL TINE

Fits most MacDon reels

Order No.	List
H174849	5.88



WHY TRY TIGER SHARK™ SECTIONS?

1. Serrated teeth allow more cutting surface.
2. They last longer, cut faster.
3. Cuts equally well in soybeans, alfalfa, grass hay, wheat, etc.

Customer Testimonial:

"I cut over 1000 acres of soybeans with the same **Herschel Tiger Shark™** sections. They stayed sharper longer and lasted longer than any section I have used." - Roger Woodruff, Warren Co. Iowa



SPLICED COMBINE SICKLES

All sickles are made bolted and headless with extra heavy chrome sections. All segments are less than 108" to ship UPS.

Model	Size	Drive	14-Tooth		Tiger Shark™	
			Order No.	List	Order No.	List
962/963	30	Single	S35-2181	600.60	S35-2879	585.52
	36	Single	S35-2182	741.77	S35-2880	718.85
972	25	Single	S35-2184	473.10	S35-2882	476.47
	30	Single	S35-2181	600.60	S35-2879	585.52
	36	Single	S35-2182	741.77	S35-2880	718.85
	21	Double			S35-2883	496.74
	25	Double	S35-2186	533.71	S35-2884	564.00
	30	Double	S35-2187	621.18	S35-2885	633.47
D50, D60, D65, FD70, FD75	36	Double	S35-2188	792.89	S35-2886	803.73
	20	Single	S35-2189	405.66	S35-2887	397.08
D50, D60, D65, FD70, FD75	25	Single	S35-2184	473.10	S35-2882	476.47
	30	Single	S35-2181	600.60	S35-2879	585.52
D50, D60, D65, FD70, FD75	35	Single	S35-2190	659.37	S35-2888	648.44
	40	Single	S35-2191	804.39	S35-2893	772.24
D50, D60, D65, FD70, FD72	20	Double	S35-2192	467.92	S35-2894	490.78
	25	Double	S35-2193	576.30	S35-2895	569.02
D50, D60, D65, FD70, FD75	30	Double	S35-2194	627.69	S35-2896	638.92
	35	Double	S35-2195	692.02	S35-2897	709.25
	40	Double	S35-2196	833.43	S35-2898	850.29
	45	Double	S35-2197	908.49	S35-2899	937.68

TIGER SHARK

Shredding The Competition



The first drastically new section tooth design in decades!

- Serrated Teeth Allows More Cutting Surface.
- Stays Sharper Longer
- Lasts Longer
- Cuts Faster
- Cuts Equally Well In Soybeans, Alfalfa, Grass Hay, Wheat, Etc.

MADE IN THE USA!

B	
Bale Counter.....	57
Baler Teeth.....	61
Bearings, Plastic Reel.....	61
Bolt-N-Clip Kit.....	57
Bolts, Section.....	57
C	
Clips, Hold Down.....	57
Combine Teeth.....	61
D	
Disc Mower Knives.....	60
E	
End Sections.....	57
G	
Grass Board.....	57
Guards.....	60
H	
Hammer Rivet Tool.....	61
Hold Down Clips.....	57
K	
Kits, Bolt-N-Clip.....	57
P	
Plastic Reel Bearings.....	61
R	
Rake Teeth.....	61
Reel Tines.....	61
Replacement Parts, Poly.....	61
Rivets, Section.....	57
S	
Sections.....	56
Section Bolts.....	57
Section Rivets.....	57
Sickle Assemblies.....	58 - 59
Sickle Head.....	57
T	
Teeth, Baler.....	61
Teeth, Combine.....	61
Teeth, Rake.....	61
Tines, Reel.....	61
W	
Wear Plate.....	57

HERSCHEL sections are made in the USA from high quality boron steel. Heat-treated for long life. Sections are extra heavy (.116") and chrome unless stated otherwise.

All MASSEY FERUGSON COMBINE sections have 2" hole spacing.

All MASSEY FERUGSON HAY MACHINES sections have 2-1/8" hole spacing.

SECTION TYPES

7TS = Super 7® Top Serrated TT = Tiger Tooth
 SM = Smooth TJ = Tiger Jaw
 US = Under Serrated - 14 Tooth SRK = Tiger Shark™
 TS = Top Serrated - 14 Tooth



SECTIONS
 Fits MASSEY Mowers 30, 31, 32, 51, 52, 71, 135, 238.
 MASSEY HARRIS 5, 6, 40, 41, 60. Section is 3" x 3-1/4".
 Uses 5/8 OH rivet. Sold 10 sections per pack.

OEM Number	Application	Order No.	List
130356M1	XHUS	S20-5743	22.24



S20-5236

SECTIONS
 Fits MASSEY Windrowers 35, 655, 675, 755, 875. Section is 3" x 3-1/4". Uses 5/8 OH rivet. Sold 10 sections per pack.

OEM Number	Application	Design	Order No.	List
1041472M1	XHUSCR -.083	C-	S20-5743	22.24



S20-5236 S20-6710

SECTIONS
 Fits MASSEY Mower conditioners, Haytender 81, 725 & 925 (Badger), 200, 210 Swathers, 7200, 8200 Grain Tables. Section is 3" x 3-1/4". Uses 5/8 OH rivet. Sold 10 sections per pack.

OEM Number	Application	Design	Order No.	List
1036362M1	XHUS	B	S20-5107	16.38
1038969M1	XHSM	B	S20-1145	19.48
683936M1	XHTSCR	B	S20-4277	23.83
683937M1	XHUSCR	B	S20-6339	20.60
3725570M1	Tiger Shark™		S20-8396	26.62



SECTION - XHTSCR
 Fits MASSEY Windrowers 34, 36, 44. Section is 3" x 3-1/4". Uses TJBN bolt. Sold 10 sections per pack.

OEM Number	Order No.	List
261431M1H	S20-4676	33.88
160254M1		
146503M1		



SECTION
 Fits MASSEY Combines with floating bar, wobble drive head. Section is 3" x 2-1/2". Uses 5/8 CS rivet. Sold 10 sections per pack.

OEM Number	Description	Design	Order No.	List
1053209M1	XHTSCR	H	S20-4462	28.28



SECTION - XH7TSCR - G+ TYPE
 Fits MASSEY Combines. Section is 3" x 3-1/4". Uses 5/8 OH rivet. Sold 10 sections per pack.

OEM Number	Order No.	List
SS261431M1H	S20-4269	31.31

WHY TRY TIGER SHARK™ SECTIONS?

1. Serrated teeth allow more cutting surface.
2. They last longer, cut faster.
3. Cuts equally well in soybeans, alfalfa, grass hay, wheat, etc.



Customer Testimonial:
 "I cut over 1000 acres of soybeans with the same *Herschel Tiger Shark™* sections. They stayed sharper longer and lasted longer than any section I have used."
 - Roger Woodruff, Warren Co. Iowa

TIGER JAW SECTIONS
 Fits all MASSEY Combines with Tiger Jaw systems. Section is 3" x 2-1/4". Uses TJ55BN bolt. Sold 10 sections per pack.

Replaces Number	Description	Section Design	Order No.	List
TJ6000	XHTJCR	S	S20-4638	24.64
SSTJ6000	XHTJCR	S+	S20-4316	27.28



S20-4462



S20-4316

TIGER SHARK

SECTION - TIGER SHARK™
 Fits MASSEY Swathers 200, 210. Section is 3" x 3-1/4". Sold 10 sections per pack.

OEM Number	Order No.	List
3725570M1	S20-8396	26.62

UNIVERSAL END SECTIONS

HERSCHEL "End Sections" are made of one-piece high carbon, heat-treated steel for rugged use. They are punched with an oblong hole to virtually fit any standard cutterbar mower in use today. To install our "End Section", simply take off the last section on the shoe end of your sickle assembly and replace it with an "End Section". The change-over takes only a couple of minutes to complete and you will notice a big difference in time saved from unclogging your mower. We recommend using a R36-0523D oval head rivets or B55-0065D Bolts.



Description	Order No	List	Description	Order No	List
XH7TSCR (RH) 10/Box	S20-4403	59.59	Tiger Shark™ (LH) 2/SP	S20-8445D	18.67
XH7TSCR (RH) 2/SP	S20-4403D	16.31	XHTS CR (RH) 10/Box	S20-4210	59.59
Tiger Shark™ (RH) 10/Box	S20-8403	64.31	XHTS CR (RH) 2/SP	S20-4210D	16.31
Tiger Shark™ (RH) 2/SP	S20-8403D	11.44	XHTSCR (LH) 10/Box	S20-4211	59.59
XH7TSCR (LH) 10/Box	S20-4445	63.81	XHTSCR (LH) 2/SP	S20-4211D	16.31
XH7TSCR (LH) 2/SP	S20-4445D	11.26	XHUSCR (RH) 10/Box	S20-6640	63.12
Tiger Shark™ (LH) 10/Box	S20-8445	64.31	XHUSCR (RH) 2/SP	S20-6640D	16.31



BOLT-N-CLIP KIT

For Most Sickles up to 10'. Converts most sickle bars to bolt-on sections.

Kit includes: Hold Down Clips, Section Bolts & Lock Nuts.

Order No.	List
B55-0629	52.17

GRASS BOARD

Fits all mowers.



Order No	List
B52-0615	67.69

BALE COUNTER

Bale counter, reads up to 99,999. 4-hole mounting plate, push button reset, adjustable side arm. Fits most balers.



Order No	List
T55-0002	30.62

SECTION BOLTS

Description	Application	Qty. Pkg.	Qty. Mstr Ctn.	Order No.	List
Section Bolt	Replaces 9/16" & 5/8" OH Rivets	50	300	B55-0065D	12.28
Head Bolt	Replaces 1" & 1 1/16" OH Rivets	15	90	B55-0085D	7.31
Head Bolt	Replaces 1-1/4" OH Rivets	12	72	B55-0095D	7.51
Section Bolt	Bolts for 10' Sickle w/head bolts (80 - B55-0065D, 5 - B55-0085D, 5-B55-0095D)	90	Each	B55-0500D	28.42
Nut	Fits All Above Bolts	20	120	N83-0289D	6.70



RIVETS

Size / No. in Pkg.	Description	Application	Qty. Pkg.	Qty. Ctn.	Order No.	List
5/8" # 5-1/2 (56)	OH Rivets Asst.	7' Heavy Mower Sections and Knife Heads	Asst.	6	R36-0523D	10.70
1" # 5-1/2 (10)	Zinc Pltd.					
5/8" # 5-1/2 (72)	OH Rivets Asst.	Mower Conditioners	Asst.	6	R36-0524D	12.31
1" # 5-1/2 (5)	Zinc Pltd.					
1-1/4" OH	OH Rivets Zinc Plt.	Head Rivet	1/2#	3	R36-0467D	8.53
5/8" OH	OH Rivets Zinc Plt.	Heavy Gauge Sections	1#	6	R36-0462D	16.74
15/16" OH	OH Rivets Zinc Plt.	Head Rivet	1/2#	3	R36-0522D	9.11
1-1/4" CS	CS Rivets Zinc Plt.	Guard Plate Rivet	1/2#	3	R36-0468D	8.28
5/8" CS	CS Rivets Zinc Plt.	Section Rivet	1#	6	R36-0463D	13.66



WEAR PLATE - 6"

For all mowers and combines.

Replaces Number	Order No.	List
206196M1	P44-0472	3.73

HEAD BUSHING

Fits MASSEY Windrowers 655, 755, 785.



Order No.	List
B82-0437B	25.60



SICKLE HEAD

Fits MASSEY Windrowers 885 Auger Header. Single and double drive. Left hand. Replaces 34388.

Order No.	List
H15-0132	78.43

HOLD DOWN CLIPS ADJUSTABLE

Fits MASSEY Mowers, Windrowers, & Swathers. Cast.

Style	Order No.	List
Low Arch	C45-0006	37.80
High Arch	C45-0007	37.80



Fits MASSEY Combines, Mowers & Windrowers, except Versatile, Hart-Carter & Love. Steel.

Style	Order No.	List
Low Arch	C45-0040	9.05



1-YEAR WARRANTY ON ALL ITEMS!

SICKLES

MOWERS DYNA-BALANCE 41, 51 S/N 238040755-LATER, 135 (WELDED GEAR BOX)

OEM #	Length	No. Of		Head OEM #	Type	Section		Riveted	Riveted	Bolted	Bolted
		Sections	Head			Section	OEM #	Order No	List	Order No	List
581177M92	7'	28	H15-0975	581387M1	XHUSCR	S20-6710	669807M1	S35-3887	242.01	-	-

MOWER CONDITIONERS 725, 925, BADGER NORTHLAND BN1000, BN1005

OEM #	Length	No. Of		Head OEM #	Type	Section		Riveted	Riveted	Bolted	Bolted
		Sections	Head			Section	OEM #	Order No	List	Order No	List
683583M91	9'	39	Headless	-	XHUSCR	S20-6339	683937M1	S35-3010	224.74	-	-

MOWER CONDITIONER 81 HAYTENDER

OEM #	Length	No. Of		Head OEM #	Type	Section		Riveted	Riveted	Bolted	Bolted
		Sections	Head			Section	OEM #	Order No	List	Order No	List
1038699M91	9'	35	Headless	-	XHUS	S20-5107	1036362M1	S35-3620	183.67	-	-

WINDROWER 35 PULL-TYPE

OEM #	Length	No. Of		Head OEM #	Type	Section		Riveted	Riveted	Bolted	Bolted
		Sections	Head			Section	OEM #	Order No	List	Order No	List
1041471M91	21'	84	Headless	-	XHTSCR	S20-4968	1046776M1	S35-4741	458.09	-	-
1050779M91	25'	100	Headless	-	XHTSCR	S20-4969	1046779M1	S35-4928	588.05	-	-

WINDROWER W/DRAPER HEAD 655, 675, 775, 785, NH 1090, WF 6200

OEM #	Length	No. Of		Head OEM #	Type	Section		Riveted	Riveted	Bolted	Bolted
		Sections	Head			Section	OEM #	Order No	List	Order No	List
1046769M91H	15'	59	H15-0870	1043844M91	XHTSCR		1046776M1	S35-4737	490.85	-	-

WINDROWERS 775, 785, 885 USING DRAPER HEADER MAC DON 7000

OEM #	Length	No. Of		Head OEM #	Type	Section		Riveted	Riveted	Bolted	Bolted
		Sections	Head			Section	OEM #	Order No	List	Order No	List
SS1057967M91	18'	71	Headless	-	XH7TSCR	S20-4398	SS1055090M1	-	-	S35-2262	464.45
SS1057508M91	21'	83	Headless	-	XH7TSCR	S20-4398	SS1055090M1	-	-	S35-2253	461.04
	4*	16	Headless	-	XH7TSCR	S20-4398	SS1055090M1	-	-	S35-2254	239.23
	9*	36	Headless	-	XH7TSCR	S20-4398	SS1055090M1	-	-	S35-2255	345.71

SICKLES

WINDROWERS 885 USING AUGER HEADER SINGLE DRIVE MAC DON 7000

OEM #	Length	No. Of		Head OEM #	Type	Section		Riveted Order No	Riveted List	Bolted Order No	Bolted List
		Sections	Head			Section	OEM #				
SS1057934M91	12'	49	Headless	-	XH7TSCR	S20-4398	SS1071707M1	-	-	S35-2258	339.55
1056866M91	14'	57	Headless	-	XHTSCR	S20-4170	1071707M1	-	-	S35-2028	347.55
SS1056866M91	14'	57	Headless	-	XH7TSCR	S20-4398	SS1071707M1	-	-	S35-2259	396.24
SS1057538M91	16'	65	Headless	-	XH7TSCR	S20-4398	SS1071707M1	-	-	S35-2260	336.75

WINDROWERS 885 USING AUGER HEADER DOUBLE DRIVE MAC DON 7000 & 9000

OEM #	Length	No. Of		Head OEM #	Type	Section		Riveted Order No	Riveted List	Bolted Order No	Bolted List
		Sections	Head			Section	OEM #				
	7 RH	29	Headless	-	XHTSCR	S20-4170	1071707M1	-	-	S35-2032	246.37
	7 LH	29	Headless	-	XH7TSCR	S20-4398	SS1071707M1	-	-	S35-2240	156.53
	7 RH	29	Headless	-	XH7TSCR	S20-4398	SS1071707M1	-	-	S35-2241	155.37
	8 LH	33	Headless	-	XHTSCR	S20-4170	1071707M1	-	-	S35-2033	293.87
	8 RH	33	Headless	-	XHTSCR	S20-4170	1071707M1	-	-	S35-2034	293.87
	8 LH	33	Headless	-	XH7TSCR	S20-4398	SS1071707M1	-	-	S35-2242	193.05
	8 RH	33	Headless	-	XH7TSCR	S20-4398	SS1071707M1	-	-	S35-2243	170.84

MOWER CONDITIONERS 34, 36, 44

OEM #	Length	No. Of		Head OEM #	Type	Section		Riveted Order No	Riveted List	Bolted Order No	Bolted List
		Sections	Head			Section	OEM #				
146471M91	16'	63	H15-0205	144306M91	XHTSCR	S20-4676	146503M2, 160254M1, 261431M1	S35-4375	489.77	-	-
146253M91	18'	71	H15-0205	144306M91	XHTSCR	S20-4676	146503M2, 160254M1, 261431M1	S35-4205	535.65	-	-

WINDROWERS 613, 625

OEM #	Length	No. Of		Head OEM #	Type	Section		Riveted Order No	Riveted List	Bolted Order No	Bolted List
		Sections	Head			Section	OEM #				
SS1069665M91	21'	83	Headless	-	XH7TSCR	S20-4398	SS34390CR	-	-	S35-2253	461.04
SS1065051M91	4*	16	Headless	-	XH7TSCR	S20-4398	SS34390CR	-	-	S35-2254	239.23
SS1065052M91	9*	36	Headless	-	XH7TSCR	S20-4398	SS34390CR	-	-	S35-2255	345.71
SS1069665M91	15*	60	Headless	-	XH7TSCR	S20-4398	SS34390CR	-	-	S35-2256	290.04

COMBINE 410, 510, 540, 550, 750, 850, 760 & 860 W/RIGID 1859 HEAD 2381 & 9000 SERIES & HINIKER

OEM #	Length	No. Of		Head OEM #	Type	Section		Riveted Order No	Riveted List	Bolted Order No	Bolted List
		Sections	Head			Section	OEM #				
SS260632M94, SS282344M93	24'	95	Headless	-	XH7TSCR	S20-4269	SS146503M3	-	-	S35-2062	735.97

HERSCHEL DISC MOWER KNIVES - MADE IN THE USA

- Manufactured in the U.S.A. to meet ISO 5718 standard on Knives for agricultural rotary disc mowers.
- Manufactured from high quality U.S.A. 10B38 (boron) steel.
- Edges are formed not ground to prevent edges from chipping & breakage.
- Entire knife is belt, not batch heat treated to a RC hardness of 45-52. Batch heat treating can cause knives on the inside of the batch to vary greatly in hardness compared to knives on the outside of the batch.
- Each knife is stamped with our name, date and lot number to allow us to trace the manufacturing process on each knife. This allows traceability of the steel back to the steel mill and the mills heat lot of the steel used in the knife.

DISC MOWER KNIVES

Fits MASSEY 164, 166, 530

Length: 3.66"	Degree of Twist: 13	Hole Diameter: .64
Width: 1.60	Thickness: 0.116	Center Of Hole To Back Edge: .80

OEM			Bolt			6 Blades			25 Blades		
Number	Style	Shape	Order No	Order No	List	Order No	Order No	List	Order No	Order No	List
CC19336	4	LH Twisted	B55-0358D	B45-6996D	15.56	B45-6996	B45-6996	46.70			
CC19333	4	RH Twisted	B55-0358D	B45-6997D	15.56	B45-6997	B45-6997	54.42			



DISC MOWER KNIVES

Fits MASSEY 1306, 1307, 1308, 1309, 1310, 1326, 1327, 1328, 1329, 1330, 1339, 1359

Length: 4.76"	Degree of Twist: 13	Hole Diameter: .89
Width: 1.88	Thickness: 0.165	Center Of Hole To Back Edge: .78

OEM			Bolt			6 Blades			25 Blades		
Number	Style	Shape	Order No	Order No	List	Order No	Order No	List	Order No	Order No	List
113385A1	5	RH Twisted	B55-0355D	B45-6563D	16.05	B45-6563	B45-6563	62.90			
113384A1	5	LH Twisted	B55-0355D	B45-6564D	16.05	B45-6564	B45-6564	62.90			



DISC MOWER KNIVES

Fits MASSEY 1345, 1355, 1365, 1372, 1375, 9070, 9075, 9080, 9175, 9185

Length: 4.21"	Degree of Twist: 13	Hole Diameter: .72
Width: 1.78	Thickness: 0.169	Center Of Hole To Back Edge: .80

OEM			Bolt			6 Blades			25 Blades		
Number	Style	Shape	Order No	Order No	List	Order No	Order No	List	Order No	Order No	List
700712888	4	RH Twisted	B55-0344D	B45-6568D	15.03	B45-6568	B45-6568	59.94			
700712889	4	LH Twisted	B55-0344D	B45-6569D	15.03	B45-6569	B45-6569	59.94			

Length: 4.21"	Degree of Twist: 13	Hole Diameter: .73
Width: 1.86	Thickness: 0.175	Center Of Hole To Back Edge: .78

OEM			Bolt			6 Blades			25 Blades		
Number	Style	Shape	Order No	Order No	List	Order No	Order No	List	Order No	Order No	List
700711857	5	RH Twisted	B55-0342D	B45-6559D	14.35	B45-6559	B45-6559	57.98			
700711858	5	LH Twisted	B55-0342D	B45-6560D	14.35	B45-6560	B45-6560	57.98			



FORGED STEEL GUARD

Fits MASSEY Mowers 30, 31, 51, 71. Replaces 67937M91. Center guard, dyna balance.

Order No	List
G81-0181	17.44



FORGED STEEL GUARD

Fits MASSEY Windrowers 655, 35, 675, 775, 785. Replaces 1041468M1, FS73-2, BU235.

Order No	List
G81-0070	19.03



FORGED STEEL GUARD

Fits MASSEY 725, 925, MF 885 Windrowers. Replaces 683476M9/994M1, FS81-DH, BU215H.

Order No	List
G81-0155	15.00
G81-0098 - Double Heat Treat	17.43
G81-0231 - Boron	17.43

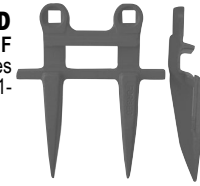

FORGED STEEL GUARD

Fits MASSEY Combines 540, 550, 750, 760, 1859 Flex (HC). Replaces FC89-2, HA231.

Order No	List
G81-0125	22.87



FORGED STEEL GUARD

Fits MASSEY Rigid combines. Replaces 228392M2, FC62-2A, HA240A.

Order No	List
G81-0191	13.40



Our Agricultural Background - Cutting Parts

Founded in 1887, by two brothers, Paul E and H. Robert Herschel. R. Herschel Manufacturing quickly became a leader in the sickle section industry.

For more than 130 years HERSCHEL has been an innovator in the cutting parts industry and introduced the chrome plated section (1950), Tiger Jaw® (1981) and Tiger Jaw 2000® (1997) combine conversion kits, Super 7® sections (1992) and most recently the Tiger Shark™ section (2016). Cutting parts designed to provide the agricultural industry with a high quality product at an exceptional value. We are proud to still make our popular cutting products at our factory in Indianola, IA.

CONICAL GUARD BOLT NUT

Package includes 5 7/16" nuts.

Order No	List
N83-0593D	7.72



RAKE TOOTH
 For MASSEY Rakes to 1958, model 20 to s/n 14449. Replaces 667656M1. Spring. 100 per box.

<u>Order No.</u>	<u>List</u>
T16-0367	2.90



RAKE TOOTH
 For MASSEY Rakes including MH21, 25 s/n 14450 - , 36, 37. Replaces 667530M0, 668364M1, DE0435A. Spring. 100 per box.

<u>Order No.</u>	<u>List</u>
T16-0335	3.34

**RUBBER MOUNT
 RAKE TOOTH**
 For MASSEY Rakes 640, 650, 660, 670, 671. Replaces RMT-1. Rubber mount. 100 per box.



<u>Order No.</u>	<u>List</u>
T16-0182	3.15



BALE TOOTH
 For MASSEY Round Balers 1440, 1560. Replaces 1053394M91. Spring. 100 per box.

<u>Order No.</u>	<u>List</u>
T16-0485	4.47

SPRING TOOTH
 For MASSEY 1440. Replaces 4000-997. 50 per box.



<u>Order No.</u>	<u>List</u>
T16-0488	7.58

• PATENTED 2 PIECE DESIGN.
 • SAVE MONEY!
 REPLACE ONLY THE TINE.



**HERSCHEL 6" 2-PIECE POLY TINES
 FOR PIPE REELS**

Description	Pkg. Qty.	Order No	List
Tine & Clamp	100/Box	T16-0740	233.22
Tine & Clamp	10/Box	T16-0745	25.00
Tine ONLY	100/Box	T16-0750	150.24



MADE IN THE USA



2 PIECE M/L REEL TINE
 For Most Pipe Style Reels with 4" bat. Replaces 782551, 1989438C1, AH136689, AH153175. Includes clamps. 100 per box.

<u>Order No.</u>	<u>List</u>
T16-0720	251.62



2 PIECE M/L REEL TINE
 For Most Pipe Style Reels with 4" bat. Replaces 782226, 1989438C1, AH136689, AH153175. Includes clamps. 10 per bag.

<u>Order No.</u>	<u>List</u>
T16-0715	23.22



M/L REEL TINE
 For T16-0715 and T16-0720. No clamps. Replaces HA100MLT. Tine only, no clamps. 100 per box.

<u>Order No.</u>	<u>List</u>
T16-0725	147.75



PLASTIC BEARING KIT
 Includes 12 bearing halves, 6 bolts, and 6 nuts.

Application: Pipe Reels with Plastic Tines used on MF 9700, 9750.

<u>Order No.</u>	<u>List</u>
B15-0925	31.07

**1-YEAR WARRANTY
 ON ALL ITEMS!**



HAMMER RIVET TOOL
 For Drive Rivets

<u>Order No.</u>	<u>List</u>
T55-0812	30.71

B

Bale Counter.....	74
Baler Teeth.....	75
Board, Grass.....	74
Bolt-N-Clip Kit.....	64
Bolts, Section.....	66

D

Disc Mower Knives.....	73 - 74
------------------------	---------

E

End Sections.....	64
-------------------	----

G

Grass Board.....	74
Guards.....	72

H

Hammer Rivet Tool.....	75
Hold Down Clips.....	73 - 74

K

Kits, Overlap Section.....	64
----------------------------	----

O

Overlap Sections.....	64
Overlap Section Kits.....	64

R

Rake Teeth.....	75
Rake Wheels.....	74
Reel Teeth.....	75
Rivets, Section.....	66

S

Sections.....	63 - 65
Section Bolts.....	66
Section Rivets.....	66
Sickle Heads.....	70
Sickles.....	66 - 70
Sickles, Versatile.....	66
Splice Kits.....	70
Spliced Sickles.....	70

T

Teeth, Baler.....	75
Teeth, Rake.....	75
Teeth, Reel.....	75

V

Versatile Sections.....	65
Versatile Sickles.....	66

W

Wear Plates.....	74
------------------	----

HERSCHEL sections are made in the USA from high quality boron steel. Heat-treated for long life. Sections are extra heavy (.116") and chrome unless stated otherwise.

All NEW HOLLAND sections have 2-1/16" hole spacing.

WHY TRY TIGER SHARK™ SECTIONS?

1. Serrated teeth allow more cutting surface.
2. They last longer, cut faster.
3. Cuts equally well in soybeans, alfalfa, grass hay, wheat, etc.



SECTION TYPES

- | | |
|--------------------------------|--------------------|
| 7TS = Super 7® Top Serrated | TT = Tiger Tooth |
| SM = Smooth | TJ = Tiger Jaw |
| US = Under Serrated - 14 Tooth | SRK = Tiger Shark™ |
| TS = Top Serrated - 14 Tooth | |

Customer Testimonial:

"I cut over 1000 acres of soybeans with the same **Herschel Tiger Shark™** sections. They stayed sharper longer and lasted longer than any section I have used."

- Roger Woodruff, Warren Co. Iowa



SECTIONS - .116" THICK

Fits NEW HOLLAND Mowers and Conditioners. Section is 3" x 3-1/4". Uses 5/8 OH rivet. Sold 10 sections per pack.

Replaces		Reference		
Number	Description	Number	Order No	List
26622	XHSM		S20-1145	19.48
29875	XHUS	B-	S20-5107	16.38
706226	XHUSCR	B-	S20-6339	20.60

SECTION - XHTSCR

Fits NEW HOLLAND TR Series Combine, 970, 971, 972, 973. Section is 3" x 3-1/4". Uses 5/8 OH rivet. Sold 10 sections per pack.

Replaces		Order No	List
Number	Order No		
694723	S20-4790		19.92



SECTION - XHTSCR

Fits NEW HOLLAND Combines with Love Floating Headers. Section is 3" x 3". Uses 5/8 CS rivet. Sold 10 sections per pack.

Replaces		Order No	List
Number	Order No		
271981 CR	S20-4608		27.87



SECTION - XHTSCR

Fits NEW HOLLAND Combines with Rigid Headers. Section is 3" x 3-1/4". Uses 5/8 OH rivet. Sold 10 sections per pack.

Replaces		Order No	List
Number	Order No		
134104	S20-4719		27.87

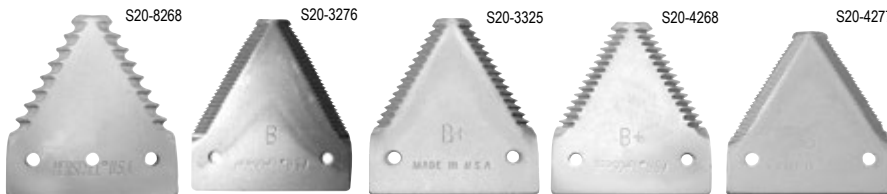

SECTIONS

Fits NEW HOLLAND Mowers and Conditioners, 71C, 72C, 73C, 74C Grain heads. Section is 3" x 3-1/4". Uses 5/8 OH rivet. Sold 10 sections per pack. *The Tiger Shark™ section can be used in place of the sections listed below.*

Replaces		Reference		
Number	Description	Number	Order No	List
	Tiger Shark™		S20-8268	19.51
9622744, 826720C3, 86615988	XHTS	B	S20-3276	16.39
9622744, 112074A1, 86616691	XH7TS	B+	S20-3325	16.31
596321R4, 86616689	XH7TSCR	B+	S20-4268	19.51
700705300, 86616527	XHTSCR	B	S20-4277	23.83



SECTIONS

Fits NEW HOLLAND NH740CH, NH880CF. Section is 3" x 3-1/4". Sold 10 sections per pack. *The Tiger Shark™ section can be used in place of the sections listed below.*

Replaces		Reference	
Number	Reference	Order No	List
		S20-8549	17.63
87728905	B+	S20-3549	17.63

S20-5127



OVERLAP SECTIONS - XHUS - .116" THICK
Fits NEW HOLLAND Double drive sickles. Section is 3" x 3-1/4". Sold 10 sections per pack.

Replaces			
Number	Rivet Used	Order No	List
635162	(Top C.S.)	S20-5127	28.55

S20-4371

S20-4370



OVERLAP SECTIONS - XHTSCR .116" THICK
Fits NEW HOLLAND Double Drive Sickles. Section is 3" x 3-1/4". Sold 10 sections per pack.

Replaces			
Number	Rivet Used	Order No	List
635161	Bottom CS	S20-4371	36.61
635162	Top CS	S20-4370	36.42

OVERLAP SECTION KIT - SUPER 7®

Fits New Holland 1475, 2200, 2300, 2450, 2550, 12HS, 14HS, 16HS and other double drive NH windrowers not using tomahawk style overlap section. Kit includes 2 of S20-4308, 4 of S20-4309, 1 wear strip, 6 5/8" CS bolts, 6 1/2" CS bolts and nuts.

Order No	List
S20-4005	30.42

S20-4308

S20-4309



OVERLAP SECTIONS - .116" THICK
Fits NEW HOLLAND Double Drive Sickles. Section is 3" x 3-1/4". Sold 10 sections per pack.

Replaces				
Number	Type	Rivet Used	Order No	List
SS635162	XH7TSCR	Top CS	S20-4308	30.43
SS635162	TIGER SHARK™	Top CS	S20-8308	27.80
SS635161	XH7TSCR	Bottom CS	S20-4309	26.82
SS635161	TIGER SHARK™	Bottom CS	S20-8309	27.80

OVERLAP SECTION KIT - TIGER SHARK™

Fits New Holland 1475, 2200, 2300, 2450, 2550, 12HS, 14HS, 16HS and other double drive NH windrowers not using tomahawk style overlap section. Kit includes 2 of S20-4308, 4 of S20-4309, 1 wear strip, 6 5/8" CS bolts, 6 1/2" CS bolts and nuts.

Order No	List
S20-8010	30.42

OVERLAP SECTION KITS - SUPER 7®

Fits New Holland 1475, 2200, 2300, 2450, 2550, 12HS, 14HS, 16HS and other double drive NH windrowers using tomahawk style overlap section.

Contains 3 bottom countersunk sections, 2, 3" Top countersunk sections, 1 Tomahawk style section, bolts and nuts.

Order No	List
S20-4008	34.85

UNIVERSAL END SECTIONS

HERSCHEL "End Sections" are made of one-piece high carbon, heat-treated steel for rugged use. They are punched with an oblong hole to virtually fit any standard cutterbar mower in use today. To install our "End Section", simply take off the last section on the shoe end of your sickle assembly and replace it with an "End Section". The change-over takes only a couple of minutes to complete and you will notice a big difference in time saved from unclogging your mower. We recommend using a R36-0523D oval head rivets or B55-0065D Bolts.

S20-4210

S20-6640



Description	Order No	List	Description	Order No	List
XH7TSCR (RH) 10/Box	S20-4403	59.59	Tiger Shark™ (LH) 2/SP	S20-8445D	18.67
XH7TSCR (RH) 2/SP	S20-4403D	16.31	XHTS CR (RH) 10/Box	S20-4210	59.59
Tiger Shark™ (RH) 10/Box	S20-8403	64.31	XHTS CR (RH) 2/SP	S20-4210D	16.31
Tiger Shark™ (RH) 2/SP	S20-8403D	11.44	XHTSCR (LH) 10/Box	S20-4211	59.59
XH7TSCR (LH) 10/Box	S20-4445	63.81	XHTSCR (LH) 2/SP	S20-4211D	16.31
XH7TSCR (LH) 2/SP	S20-4445D	11.26	XHUSCR (RH) 10/Box	S20-6640	63.12
Tiger Shark™ (LH) 10/Box	S20-8445	64.31	XHUSCR (RH) 2/SP	S20-6640D	16.31

S20-8445



BOLT-N-CLIP KIT

Bolts are Better Than Rivets

- Bolts will not turn in Knife Back and are reusable.
- They will last thru the life of several sections.
- Bolts may be replaced easily if accidentally damaged or broken.
- No special tools are needed to change sections, only a 7/16" wrench or socket.
- Bolts and nuts hold better than rivets and they have a greater "clamp load" than rivets.



Fits NEW HOLLAND Mowers, Mower Conditioners and Combines up to 10'. Includes special high clearance hold down clips, over the head clip, section bolts and lock nuts.

Order No.	List
B55-0629	52.17

HERSCHEL sections are made in the USA from high quality boron steel. Heat-treated for long life. Sections are extra heavy (.116") and chrome unless stated otherwise.

All NEW HOLLAND sections have 2-1/16" hole spacing.

SECTION TYPES

- 7TS = Super 7® Top Serrated
- SM = Smooth
- US = Under Serrated - 14 Tooth
- TS = Top Serrated - 14 Tooth
- TT = Tiger Tooth
- TJ = Tiger Jaw
- SRK = Tiger Shark™

WHY TRY TIGER SHARK™ SECTIONS?

1. Serrated teeth allow more cutting surface.
2. They last longer, cut faster.
3. Cuts equally well in soybeans, alfalfa, grass hay, wheat, etc.



Customer Testimonial:

"I cut over 1000 acres of soybeans with the same **Herschel Tiger Shark™** sections. They stayed sharper longer and lasted longer than any section I have used." - Roger Woodruff, Warren Co. Iowa

S20-4639

S20-4317

S20-8398

S20-4398

S20-3283

TIGER JAW SECTIONS
Fits NEW HOLLAND Combines with Tiger Jaw systems. Section is 3" x 3-1/4". Uses TJ55BN bolt. Sold 10 sections per pack. Top countersunk.

Replaces		Reference		
Number	Description	Number	Order No	List
TJ7000	XHTTCR	R	S20-4639	27.29
TJ7000	XH7TTCR	R+	S20-4317	27.28

Replaces		Reference		
Number	Description	Number	Order No	List
	Tiger Shark™		S20-8398	19.51
87422066CR	XH7TSCR	C+	S20-4398	19.51
1327448C1	XHTS	C	S20-3283	20.00
137448C1CR	XH7TTCR		S20-4170	26.18

FORD SECTIONS

S20-5246

S20-6344

S20-1142

SECTION - XH7TS
Fits FORD Mowers, Windrowers and Swathers. Section is 3" x 3-1/4". Sold 10 sections per pack.

Order No	List
S20-3407	17.27

SECTIONS
Fits FORD Mowers. Section is 3" x 3-1/4". Sold 10 sections per pack.

Replaces		Reference		
Number	Description	Number	Order No	List
141198, 141113	XHUS	A-	S20-5246	17.41
141198 CR	XHUSCR	A-	S20-6344	31.31
141197	XHSM		S20-1142	20.47

VERSATILE SECTIONS

SECTIONS - .116" THICK
Fits VERSATILE Windrowers 10, 103, 400, 4400. Section is 3" x 3". Uses B55-0065D bolt. Sold 10 sections per pack.

Replaces		Reference		
Number	Description	Number	Order No	List
SSVS1616BN	XH7TS (w/Low Shoulder)	D+	S20-3425	24.49

SECTION BOLTS

- Quick and easy section changes are possible with bolts.
- No more cutting, chiseling, or grinding - simply unbolt the section, replace and tighten bolts.
- Bolts will not turn in Knife Back and are reusable. They will last thru the life of several sections.
- Bolts may be replaced easily if accidentally damaged or broken.
- No special tools are needed to change sections, only a 7/16" wrench or socket.
- Bolt and nuts hold better than rivets and they have a greater "clamp load" than rivets.
- Special lock nuts will not vibrate loose.

Description	Qty. Application	Qty. Pkg.	Mstr.	Order No.	List
Section Bolt w/nut	Universal - Replaces 9/16" & 5/8" OH Rivets	50	300	B55-0065D	12.28
Head Bolt w/nut	Universal - Replaces 1-1/2" & 1-1/16" OH Rivets	15	90	B55-0085D	7.31
Head Bolt w/nut	Universal - 1-1/2" OH Rivets	12	72	B55-0095D	7.51
Section Bolt w/nut	Universal - Bolts for 10' Sickle w/head Bolts Include (80) B55-0065, (5) B55-0085, (5) B55-0095	90	Each	B55-0500D	28.42
Nut	Universal - Used On All Above Bolts	20	120	N83-0289D	6.70
Conical Guard Bolt Nut	For 7/16" Bolt	5	30	N83-0593D	7.72
Low Profile Nut	Double Drive Sickles for Overlap Bolts	20	120	N83-0295D	6.90
5/8" Bolt & Nut, Oval Shoulder, For Sections	Versatile - Windrower 4400, 2400, 2800	20	120	B55-0955D	10.02
7/8" Bolt & Nut, Oval Shoulder, For Heads	Versatile - Windrower 4400, 2400, 2800	10	60	B55-0975D	4.80
Overlap Bolt w/low profile nut 1/2" CS	Double Drive Sickles (use with Allen Wrench)	10	60	B55-0059D	9.40
9/16" CS Section Bolt & Nut	Countersunk Bolt. 60°	20	120	B55-0056D	13.52
5/8" Section Bolt & Nut	Countersunk Bolt. 60°	20	120	B55-0057D	6.31
1" CS Head Bolt & Nut	Versatile - Head Bolt	10	60	B55-0058D	10.68



RIVETS

Size/No. in Pkg.	Description	Application	Qty. Pkg.	Mstr. Ctn.	Order No.	List
5/8" # 5-1/2 (56)	OH Rivets Asst.	7' Heavy Mower Sections	Asst.	6	R36-0523D	10.70
1" # 5-1/2 (10)	Zinc Pltd.	and Knife Heads				
5/8" # 5-1/2 (72)	OH Rivets Asst.	Mower Conditioners	Asst.	6	R36-0524D	12.31
1" # 5-1/2 (5)	Zinc Pltd.					
1-1/4" # 5-1/2 (5)						
5/8" OH #5-1/2	OH Rivets Zinc Plt.	Heavy Gauge Sections	1#	6#	R36-0462D	16.74
15/16" OH #5-1/2	OH Rivets Zinc Plt.	Head Rivet	1/2#	3#	R36-0522D	9.11
1-1/4" OH #5-1/2	OH Rivets Zinc Plt.	Head Rivet	1/2#	3#	R36-0467D	8.53
5/8" CS #5-1/2	CS Rivets Zinc Plt.	Section Rivet	1#	6#	R36-0463D	13.66
1-1/4" CS #5-1/2	CS Rivets Zinc Plt.	Guard Plate Rivet	1/2#	3#	R36-0468D	8.28



VERSATILE SICKLE ASSEMBLIES RIVETED AND BOLTED

S35-4551



LS = Low Shoulder
HS = High Shoulder

OEM #	Section Type	No. Of Sections	Size	Application	Section Number	Description	Head Number	Riveted Order No	Riveted List	Bolted Order No	Bolted List
SWA3311CR	R TS CR	(80)	20'	Windrowers* 10. 103. 400. Pull Type 10. 4400	SW 1776 CR	HS	SWA 28253	S35-4274	483.07	-	-
SSVS4-SB	H7TS	(16)	4' Ext.		SSVS1616BN	LS	Less Head	-	-	-	-
SSVS15-SB	H7TS	(60)	15'		SSVS1616BN	LS	Less Head	-	-	S35-1084	330.75
SSVS20-SB	H7TS	(80)	20'		SSVS1616BN	LS	Less Head	-	-	S35-1086	505.91
SSVS22-SB	H7TS	(88)	22'		SSVS1616BN	LS	Less Head	-	-	S35-1087	571.00
*Note: Bolted sickles use B55-0955D 5/8" Oval CTSK Shoulder Bolts.											
6832174	H TS CR	(28)	7' LH	4814 Auger Header	700705300		6821078 LH	S35-4390	361.68	-	-
6832224	H TS CR	(29)	7' RH	4814 Auger Header	700705300		6821136 RH	S35-4391	361.68	-	-
SSBN6832174	XH7TS CR	(28)	7' LH	4814 Auger Header	SS700705300		6821078 LH	-	-	S35-2285	293.88
SS6832224	XH7TS CR	(28)	7' RH	4814 Auger Header	SS700705300		6821136 RH	-	-	S35-2286	293.71

SICKLES

FORD MOWERS 515 SERIES

OEM #	Length	No. Of Sections	Head	Head OEM #	Type	Section	Section OEM #	Riveted Order No	Riveted List	Bolted Order No	Bolted List
241905	7'	(29)		242063	XHUS		141198	S35-3367	249.36	-	

FORD MOWERS 175, 176, 257, 258, 259, 260, 501 SERIES, 14-94, 95, 96, 97

OEM #	Length	No. Of Sections	Head	Head OEM #	Type	Section	Section OEM #	Riveted Order No	Riveted List	Bolted Order No	Bolted List
240890	7'	(28)		147874	XHSM		141197	S35-3658	260.67	-	
240891	7'	(28)		147874	XHUS		141198	S35-3659	176.80	-	

FORD MOWERS 505 SERIES AND 538

OEM #	Length	No. Of Sections	Head	Head OEM #	Type	Section	Section OEM #	Riveted Order No	Riveted List	Bolted Order No	Bolted List
462381R9	7'	(28)		56692C91	XHSM		26622	S35-3668	205.43	-	
462380R9	7'	(28)		56692C91	XHUS		29875	S35-3667	159.22	-	
463182R9	9'	(36)		56692C91	XHSM		26622	S35-3672	183.83	-	
463159R9	9'	(36)		56692C91	XHUS		29875	S35-3669	169.57	-	

FORD MOWERS 535

OEM #	Length	No. Of Sections	Head	Head OEM #	Type	Section	Section OEM #	Riveted Order No	Riveted List	Bolted Order No	Bolted List
290627S	9'	(35)	Less Head	-	XHUS		OU577HS	S35-3620	183.67	-	

FORD MOWER/CONDITIONER 538

OEM #	Length	No. Of Sections	Head	Head OEM #	Type	Section	Section OEM #	Riveted Order No	Riveted List	Bolted Order No	Bolted List
101988C91	9'	(37)		824594C91	XHUS		29875	S35-3292	410.60	-	

NEW HOLLAND MOWERS 44, 45, 46, 47

OEM #	Length	No. Of Sections	Head	Head OEM #	Type	Section	Section OEM #	Riveted Order No	Riveted List	Bolted Order No	Bolted List
MA22837	7'	(28)		MA999	XHUS		826722C1	S35-3630	163.36	-	

NEW HOLLAND MOWER 450 AFTER S/N 87764 AND 455 AFTER S/N 88846 451 WITH SINGLE GUARDS

OEM #	Length	No. Of Sections	Head	Head OEM #	Type	Section	Section OEM #	Riveted Order No	Riveted List	Bolted Order No	Bolted List
143607	7'	(28)		858740	XHUS		29875	S35-3389	225.07	-	
143609	9'	(36)		858740	XHUS		29875	S35-3390	227.75	-	
143609	9'	(36)		858740	XHTS		29875	S35-3342	309.16	-	

NEW HOLLAND MOWERS 451 AND 456 WITH DOUBLE GUARDS

OEM #	Length	No. Of Sections	Head	Head OEM #	Type	Section	Section OEM #	Riveted Order No	Riveted List	Bolted Order No	Bolted List
SS228435	7'	(29)		858740	XH7TS		SS9622744	-		S35-1024	325.18
SS858744	7'	(29)		858740	XH7TSCR		SS604921H	-		S35-2289	243.61
TT228435	7'	(29)		TT143603	XHTTCR		9622744	-		S35-2566	249.07
SSTT228435	7'	(29)		TT143603	XH7TTCR		SSTJ7000	-		S35-2362	162.89
5228435	7'	(29)		143603	XHUS		29875	S35-3884	165.87		
					Tiger Shark™					S35-2558	238.96
858745	9'	(35)		858740	XHUS		29875	-		S35-1704	261.43
					Tiger Shark™					S35-2552	244.97
SS858745	9'	(35)		858740	XH7TSCR		SS29875	-		S35-2128	213.74
228434	9'	(35)		858740	XH7TS		29875	S35-3006	179.06	-	
228434	9'	(35)		143603	XHUS		29875	S35-3885	208.53	-	

NEW HOLLAND MOWER CONDITIONER 460 AND 461

OEM #	Length	No. Of Sections	Head	Head OEM #	Type	Section	Section OEM #	Riveted Order No	Riveted List	Bolted Order No	Bolted List
134186	9'	(35)		86507377	XHUS		29875	S35-3282	296.24	-	

NEW HOLLAND MOWER CONDITIONER 467

OEM #	Length	No. Of Sections	Head	Head OEM #	Type	Section	Section OEM #	Riveted Order No	Riveted List	Bolted Order No	Bolted List
137214	7'	(29)		86507377	XHUS		29875	S35-3057	252.58	-	

SICKLES

NEW HOLLAND MOWER CONDITIONER 469, 1469

OEM #	Length	No. Of Sections	Head	Head OEM #	Type	Section	Section OEM #	Riveted Order No	Riveted List	Bolted Order No	Bolted List
648844	9'	(37)	-	86507377	XHUS	-	29875	S35-3055	243.42	S35-1705	273.74
SS86518678	9'	(37)	-	86507377	XH7TS	-	SS9622744	-	-	S35-3164	327.75

NEW HOLLAND MOWER CONDITIONER MODEL 495 AND 1495

OEM #	Length	No. Of Sections	Head	Head OEM #	Type	Section	Section OEM #	Riveted Order No	Riveted List	Bolted Order No	Bolted List
648003	12'	(49)	-	86508155	XHUS	-	29875	S35-3128	361.16	-	-
858706	12'	(49)	-	86508155	XHUS	-	29875	-	-	S35-1708	413.00
SS9623572	12'	(49)	-	86508155	XH7TS	-	SS9622744	-	-	S35-1001	389.04

NEW HOLLAND MODEL 472, 477, 478

OEM #	Length	No. Of Sections	Head	Head OEM #	Type	Section	Section OEM #	Riveted Order No	Riveted List	Bolted Order No	Bolted List
648832	7'	(29)	-	577868	XHUS	-	29875	S35-3864	240.74	-	-
858708	7'	(29)	-	577868	XHUS	-	29875	-	-	S35-1280	322.15

NEW HOLLAND MOWER CONDITIONER 479, 488, 1469 AFTER S/N 220947

OEM #	Length	No. Of Sections	Head	Head OEM #	Type	Section	Section OEM #	Riveted Order No	Riveted List	Bolted Order No	Bolted List
648840	9'	(37)	-	577867	XHUS	-	29875	S35-3865	249.51	-	-
858700	9'	(37)	-	577867	XHUS	-	29875	-	-	S35-2560	279.06
SS9623570	9'	(37)	-	577867	XH7TS	-	SS9622744	-	-	S35-1706	307.26
SSTT648840	9'	(37)	-	TT577867	XH7TSCR	-	SSTJ7000	-	-	S35-3165	302.49
										S35-2052	456.61

NEW HOLLAND MOWER CONDITIONER 490 (S/N 259715 AND UP)

OEM #	Length	No. Of Sections	Head	Head OEM #	Type	Section	Section OEM #	Riveted Order No	Riveted List	Bolted Order No	Bolted List
579171	12'	(49)	-	86512652	XHUS	-	29875	S35-3076	424.97	-	-

NEW HOLLAND MOWER CONDITIONER 474, 489, 492 AND 1465

OEM #	Length	No. Of Sections	Head	Head OEM #	Type	Section	Section OEM #	Riveted Order No	Riveted List	Bolted Order No	Bolted List
648831	7'	(29)	-	289488	XHUS	-	29875	S35-3375	369.73	-	-
858702	9'	(37)	-	289488CS	XHUS	-	29875	-	-	S35-1707	329.77
SS86529232	9'	(37)	-	289488CS	XH7TS	-	29875	-	-	S35-3165	302.49
SS86529232	9'	(37)	-	289488CS	Tiger Shark™	S20-8268	-	-	-	S35-2561	304.67
SSTT648835	9'	(37)	-	TT289488CS	XH7TTCR	-	SSTJ7000	-	-	S35-2051	335.15
648835	X9'	(37)	-	289488	XHUS	-	29875	S35-3283	297.66	-	-

NEW HOLLAND MOWER CONDITIONER 499, 1496, WINDROWER 1499

OEM #	Length	No. Of Sections	Head	Head OEM #	Type	Section	Section OEM #	Riveted Order No	Riveted List	Bolted Order No	Bolted List
635163	6' LH	(24)	-	86536346	XHUS	-	29875	S35-3798	377.41	-	-
9619698	6' LH	(24)	-	86536346	XHUS	-	29875	-	-	S35-1128	293.57
635279	6' RH	(25)	-	86536345	XHUS	-	29875	S35-3799	421.27	-	-
9619699	6' RH	(25)	-	86536345	XHUS	-	29875	-	-	S35-1129	293.57
SS9622712	6' LH	(24 or 25)	-	86536346	XH7TS	-	SS9622744	-	-	S35-1006	235.81
SS9622713	6' RH	(25)	-	86536345	XH7TS	-	SS9622744	-	-	S35-1007	234.93

*Sickle comes with 25 sections. Count sections on old sickle and take 1 off at head end if need 24.

NEW HOLLAND MODEL 109 PULL TYPE

OEM #	Length	No. Of Sections	Head	Head OEM #	Type	Section	Section OEM #	Riveted Order No	Riveted List	Bolted Order No	Bolted List
276639 CR	25'	(100)	-	Less Head	XHTSCR	-	275522	S35-4928	588.05	-	-

NEW HOLLAND WINDROWER 1090 SELF PROPELLED

OEM #	Length	No. Of Sections	Head	Head OEM #	Type	Section	Section OEM #	Riveted Order No	Riveted List	Bolted Order No	Bolted List
275503	15'	(59)	-	275506	XHTSCR	-	275521	S35-4737	490.85	-	-

SICKLES

NEW HOLLAND WINDROWER 1100 HIGH PERFORMANCE HEADER 1112,1114,1116,1118,116 (14' & 16')

OEM #	Length	No. Of Sections	Head	Head OEM #	Type	Section	Section OEM #	Riveted Order No	Riveted List	Bolted Order No	Bolted List
SSTT247987	7' LH	(28)		247989	XH7TTCR		SSTJ7000	-		S35-2363	445.54
SSTT247988	7' RH	(29)		247970	XH7TTCR		SSTJ7000	-		S35-2364	445.54
247987	7' LH	(28)		247989	Tiger Shark™			-		S35-2521	257.60
9619696	7' LH	(28)		247989	XHTSCR		604800	-		S35-2755	374.29
247988	7' RH	(29)		247990	Tiger Shark™			-		S35-2523	238.45
9619697	7' RH	(29)		247990	XHTSCR		604800	-		S35-2756	367.36
TS247988	7' RH	(29)		247990	XHTSCR		604921	S35-4040	185.87	-	-
XH7TS247987	7' LH	(28)		247989	XHSTSCRS		604921H	-		S35-2005	253.88
XH7TS247988	7' RH	(29)		247990	XHSTSCRS		604921H	-		S35-2006	253.88
858724	7' LH	(28)		247990	XHTSCR		604921H	-		S35-2755	374.29
858725	7' RH	(29)		247989	XHTSCR		604921H	-		S35-2756	367.36
TS264987	8' LH	(32)		247989	XHTSCR		604921	S35-4036	206.29	-	-
TS264985	8' RH	(33)		247990	XHTSCR		604921	S35-4041	197.15	-	-
858722	8' LH	(32)		247989	XHTSCR		604921H	-		S35-2758	304.13
858723	8' RH	(33)		247990	XHTSCR		604921H	-		S35-2759	311.83

NEW HOLLAND WINDROWER 907, 909, 910, 912, 1112, 1114, 1116, 1118, 116, 114, 1100

OEM #	Length	No. Of Sections	Head	Head OEM #	Type	Section	Section OEM #	Riveted Order No	Riveted List	Bolted Order No	Bolted List	
264987	8' LH	(32)		858713	XH7TSCR		SS604921H	-		S35-2058	305.52	
264985	8' RH	(33)		858714	XH7TSCR		SS604921H	-		S35-2059	305.52	
HTS264987-S	8' LH	(32)		Less Head	XHTSCR		604921H	-		S35-2972	257.05	
HTS264985-S	8' RH	(33)		Less Head	XHTSCR		604921H	-		S35-2973	257.05	
HTS247987-S	7' LH	(28)		Less Head	XHTSCR		604921H	S35-4533	223.81	S35-2417	155.53	
HTS247988-S	7' RH	(29)		Less Head	XHTSCR		604921H	S35-4534	264.52	S35-2418	155.53	
706418	7' RH	(29)		Less Head	XHTSCR		604921	-		S35-2849	222.13	
706416	8' RH	(33)		Less Head	XHTSCR		604921	-		S35-2851	221.15	
SS706417	7' LH	(28)		Less Head	XH7TSCR		SS604921H	-		S35-2007	170.64	
SS706418	7' RH	(29)		Less Head	XH7TSCR		SS604921H	-		S35-2008	170.64	
139180	RH Knife Back Overlap Bar								S35-6075	26.75	-	-

NEW HOLLAND WINDROWER MODELS 1475, 2200, 2300, 2450 AND 2550, HS SERIES HEADER 12HS, 14HS, 16HS

OEM #	Length	No. Of Sections	Head	Head OEM #	Type	Section	Section OEM #	Riveted Order No	Riveted List	Bolted Order No	Bolted List
86509304	7' LH	(29)		Headless	XH7TSCR		SS604921H	-		S35-2049	180.24
86509305	7' RH	(29)		Headless	XH7TSCR		SS604921H	-		S35-2050	180.24
86509302	8' LH	(33)		Headless	XH7TSCR		SS604921H	-		S35-2233	264.69
86509303	8' RH	(33)		Headless	XH7TSCR		SS604921H	-		S35-2234	261.19
9826391	9' RH	(37)		9622855, 186617752	XH7TSCR		SS604921H	-		S35-2914	355.62
9826390	9' LH	(37)		9622854, 186617755	XH7TSCR		SS604921H	-		S35-2915	355.62
85605851	9' LH	(37)		Headless	XH7TSCR		SS604921H	-		S35-2063	325.99
86505852	9' RH	(37)		Headless	XH7TSCR		SS604921H	-		S35-2064	325.99
86616534	7' LH	(29)	Yes	9622854	XH7TSCR		SS604921H	-		S35-2037	270.37
					Tiger Shark™					S35-2533	249.46
Have Tomahawk Overlap Section				Headless	XH7TSCR					S35-1539	180.33
86616535	7' RH	(29)	Yes	9622855	XH7TSCR		SS604921H	-		S35-2038	270.37
					Tiger Shark™					S35-2534	249.46
Have Tomahawk Overlap Section				Headless	XH7TSCR					S35-1540	180.33
86502116	8' LH	(33)	Yes	9622854	XH7TSCR		SS604921H	-		S35-2039	296.11
					Tiger Shark™					S35-2550	274.57
86502117	8' RH	(33)	Yes	9622855	XH7TSCR		SS604921H	-		S35-2040	296.11
					Tiger Shark™					S35-2551	273.19
86616720	9' LH				Tiger Shark™		SS604921H	-		S35-8000	283.51
86616721	9' RH				Tiger Shark™		SS604921H	-		S35-8001	283.51

UNIVERSAL SICKLES - NEW HOLLAND 2-1/16" SPACING

Application	Description	Head Number	Riveted Order No.	Riveted List	Bolted Order No.	Bolted List
Mowers 450, 451, 455, 456, M/C, 460,	7' X 7TS Knf	Headless	-		S35-1038	124.53
461, 467, 469, 1469, 472, 477, 478, 479,	9' X 7TS Knf	Headless	-		S35-1039	146.18



SPLICED SICKLES - SINGLE DRIVE LESS HEAD

Fits NEW HOLLAND 3" SYSTEMS. COMBINES WITH 970, 971, 972, & 973 SINGLE DRIVE PLATFORMS.

Complete Sickle - Bolted, 14 Tooth Sections

OEM Number	HTSCR Section Number	No. of Sections	Size	Segments			# Sections To Cut Off	Order No.	List
				5' LH Head Seg.	5' Ext. S35-2820	2' Ext. S35-2824			
851663	694723	63	16'	1	2	1	4	S35-2837	635.58

Note: Use H15-0752 Head if needed.



SPLICE KIT

For 2-1/16" hole spacing. Kit contains 2 straps along with the bolts & nuts. For 200, 900 Series headers.

Order No.	List
C83-0755	26.70

SPLICED SICKLES - DOUBLE DRIVE LESS HEAD

Fits NEW HOLLAND 1.5" SYSTEMS. COMBINES WITH 970, 971, 972, & 973 DOUBLE DRIVE PLATFORMS

Complete Sickle

Section Number	No. of Sections	Size	Segments					Order No.	List	
			5' LH Head Seg. S35-2507	5' LH Overlap Seg. S35-2508	5' RH Head Seg. S35-2509	5' RH Overlap Seg. S35-2510	2.5' 2' Ext. Seg. S35-2511			5' 5' Ext. Seg. S35-2277
SSTJ6700	50	25' LH	1	1	-	-	1	-	S35-2503	508.19
SSTJ6700	58	30' RH	-	-	1	1	-	1	S35-2506	490.51

Use H15-0060 LH Head, H15-0061 RH Head if needed. (For Tiger Jaw applications only.)

Use H15-0752 Head if needed. (For OEM 1.5" Systems only.)



BOLTS FOR SPLICE KITS

Bolts and nuts for splice kits listed above. 12 each per package.

Order No.	List
B55-0049D	11.36



SICKLE HEAD

Fits FORD Mower Conditioner 538.

Order No.	List
H15-0283	293.33



SICKLE HEAD

Fits FORD Mowers 505 Series. Replaces 462378R1.

Order No.	List
H15-0281	72.35



SICKLE HEAD - LEFT HAND

Fits NEW HOLLAND 1475, 2450 & 2550. Replaces 9622854.

Order No.	List
H15-0355	137.98



SICKLE HEAD - RIGHT HAND

Fits NEW HOLLAND 1475, 2450 & 2550. Replaces 9622855.

Order No.	List
H15-0356	124.19



SICKLE HEAD

Fits NEW HOLLAND Mowers 450 (S/N 87765-) 455 (S/N 88847), 451 & 456. Replaces 858740, 143603.

Order No.	List
H15-0208	100.56



SICKLE HEAD

Fits NEW HOLLAND Mower Conditioner 460, 461, 467, 469, 490 (Up to S/N 259714). Replaces 86507377.

Order No.	List
H15-0866	137.10



SICKLE HEAD

Fits NEW HOLLAND Mower Conditioners 472, 477 & 478. Replaces 577868.

Order No.	List
H15-0863	153.16



SICKLE HEAD

Fits NEW HOLLAND 44, 45, 46, 47. Replaces MA999.

Order No.	List
H15-0257	90.27



SICKLE HEAD

Fits NEW HOLLAND Mower Conditioners 488 & 479 490 (S/N 259715-), 1469 (S/N 220947-). Replaces 577867.

Order No.	List
H15-0862	141.49



SICKLE HEAD

Fits NEW HOLLAND Mower Conditioners 474, 489, 492, 1465. Replaces 289488.

Order No.	List
H15-0488	177.18

1-YEAR WARRANTY ON ALL ITEMS!



HEAD BUSHING

Fits NEW HOLLAND Mowers 450 (S/N 87764-) 455 (S/N 88846 & Up), 1496, Windrower 1499. Replaces 127610.

<u>Order No.</u>	<u>List</u>
B82-0062B	31.36



HEAD BUSHING

Fits NEW HOLLAND Mower Conditioners 460, 461, 467, 469, 490 (S/N - 259714), 1469. Replaces 134182.

<u>Order No.</u>	<u>List</u>
B82-0381B	53.04



HEAD BUSHING

Fits NEW HOLLAND Mower Conditioners 472, 477, 478, 479, 488, 490, 495, 1495. Replaces 254132.

<u>Order No.</u>	<u>List</u>
B82-0426B	58.10



HEAD BUSHING

Fits NEW HOLLAND Mower Conditioners 905, 907, 909, 910, 912, 1100, 1112, 1114, 1116, 114, 116, 118. Replaces 76417.

<u>Order No.</u>	<u>List</u>
B82-0068B	45.13

BUSHING ASSEMBLY

Fits NEW HOLLAND Mower Conditioners 474, 489, 492, 1465, Combine 972, 973. Replaces 612408A.

<u>Order No.</u>	<u>List</u>
B82-0211B	80.55



HEAD BUSHING - SILENT BLOCK

Fits VERSATILE Windrowers 10, 103, 400, 4400. Replaces SW1740.

<u>Order No.</u>	<u>List</u>
B82-0437B	25.60



FORGED STEEL GUARD

Fits NEW HOLLAND **Mowers**. Replaces 219190, FS93-2, BU218, FS93-2DH.

Order No	List
G81-0184	15.81
G81-0144 - Double Heat Treat	17.43



FORGED STEEL GUARD

Fits NEW HOLLAND **Combines with floating bars (LOVE)**. Replaces FC90-2, BU275.

Order No	List
G81-0196	13.40



FORGED STEEL GUARD

Fits NEW HOLLAND **Windrowers and Mower Conditioners**. Replaces FS81-2, BU215H, BU215A, HA215DH, FS81DH.

Order No	List
G81-0155	15.00
G81-0098 - Double Heat Treat	17.43
G81-0231 - Boron	20.82



FORGED STEEL GUARD

Fits NEW HOLLAND **Mower/Cond. & Windrowers**. Replaces 049312, FS 86-2, HA250. Stub guard.

Order No	List
G81-0120	13.40



FORGED STEEL GUARD

Fits NEW HOLLAND **536**. Replaces 110-32327, 110-32342.

Order No	List
G81-0197	15.81



FORGED STEEL GUARD

Fits NEW HOLLAND **Windrowers**. Replaces FT 77-2, HA260, BU260. Tie guard

Order No	List
G81-0085	19.61



FORGED STEEL GUARD

Fits NEW HOLLAND **Mower Conditioners**. Replaces FS92-2, BU206, 110-323275.

Order No	List
G81-0140	26.09



FORGED STEEL GUARD

Fits NEW HOLLAND **Windrowers, Mower Conditioners, 971, 973, 71C, 73C, 74C Headers**. Replaces 86615983, 87042360, 215DH. Center Guard

Order No	List
G81-0093	25.55



FORGED STEEL GUARD

Fits NEW HOLLAND **Windrowers, Mower Conditioner 538**. Replaces FC85-2, BU210, 483500R3.

Order No	List
G81-0183	14.73



MALLEABLE GUARDS

Fits **7/16" Bars**. Fits NEW HOLLAND **Mowers**.

Replaces	Description	Order No	List
DM700, T27293	Center Guard	G81-0803	8.24
FD800	Center Guard	G81-0807	10.09
MC2041Z	Center Guard	G81-0830	14.85



FORGED STEEL GUARD

Fits NEW HOLLAND **740CR, 880CF Combine Heads**. Replaces 87702973 BU973.

Order No	List
G81-0973	19.25



GUARD PLATE

Fits NEW HOLLAND/FORD **Mowers**. Use with G81-0778, G81-0821. Replaces 142570.

Order No.	List
P44-0603	15.44



FORGED STEEL HEAD GUARD

Fits NEW HOLLAND **740CR, 880CF Combine Heads**. Four used by drive head. Replaces 87702974 and BU974.

Order No	List
G81-0974	19.25



FORGED STEEL GUARD

Fits **VERSATILE Windrowers**. Replaces FS67-2, BU290, SW 1605.

Order No	List
G81-0197	15.81



DISC MOWER KNIVES

Fits NEW HOLLAND 408, 411, 412, 415

Length: 4.21" Degree of Twist: 13 Hole Diameter: .72
Width: 1.78 Thickness: 0.169 Center Of Hole To Back Edge: .80

OEM Number	Style	Shape	Bolt Order No	6 Blades Order No	List	25 Blades Order No	List
853819	4	RH Twisted	B55-0344D	B45-6568D	15.03	B45-6568	59.94
853820	4	LH Twisted	B55-0344D	B45-6569D	15.03	B45-6569	59.94



DISC MOWER KNIVES

Fits NEW HOLLAND 411 TO 711915, 453, 463.

Length: 4.72" Degree of Twist: 13 Hole Diameter: .73
Width: 1.79 Thickness: 0.170 Center Of Hole To Back Edge: .78

OEM Number	Style	Shape	Bolt Order No	6 Blades Order No	List	25 Blades Order No	List
784220	4	LH Twisted	B55-0358D	B45-6565D	15.91	B45-6565	62.07
784221	4	RH Twisted	B55-0358D	B45-6566D	15.91	B45-6566	62.07



DISC MOWER KNIVES

Fits NEW HOLLAND ALL 442 & 462.

Length: 3.78" Degree of Twist: 0 Hole Diameter: .64
Width: 1.55 Thickness: 0.110 Center Of Hole To Back Edge: .71

OEM Number	Style	Shape	Bolt Order No	6 Blades Order No	List	25 Blades Order No	List
274230	1	Flat	B55-0358D	B45-6175D	13.18	B45-6175	51.25



DISC MOWER KNIVES

Fits NEW HOLLAND 462 TO 51121643.

Length: 3.66" Degree of Twist: 13 Hole Diameter: .64
Width: 1.60 Thickness: 0.116 Center Of Hole To Back Edge: .80

OEM Number	Style	Shape	Bolt Order No	6 Blades Order No	List	25 Blades Order No	List
274096	4	LH Twisted	B55-0358D	B45-6996D	15.56	B45-6996	46.70
274097	4	RH Twisted	B55-0358D	B45-6997D	15.56	B45-6997	54.42



DISC MOWER KNIVES

Fits NEW HOLLAND 462 AFTER 51121643, 452, 442

Length: 3.75" Degree of Twist: 13 Hole Diameter: .64
Width: 1.78 Thickness: 0.140 Center Of Hole To Back Edge: .75

OEM Number	Style	Shape	Bolt Order No	6 Blades Order No	List	25 Blades Order No	List
766726	4	LH Twisted	B55-0358D	B45-6122D	14.21	B45-6122	60.19
766727	4	RH Twisted	B55-0358D	B45-6123D	14.21	B45-6123	60.19



DISC MOWER KNIVES

Fits NEW HOLLAND 615, 616, 617, 720HD, 750HD, 1409, 1410, 1411, 1412, 1431, 1432, 1441, 1442, 2331, 2332, 2353, 2355, 2358, DCX101, DCX131, DCS161, RDX161, H6730, H6740, H6750, H7220, H72230H, H7320, H7330.

Length: 4.21" Degree of Twist: 13 Hole Diameter: .90
Width: 1.90 Thickness: 0.160 Center Of Hole To Back Edge: .75

OEM Number	Shape	Bolt Order No	6 Blades Order No	List	25 Blades Order No	List
9847684	LH Twisted	N/A	B45-6721D	15.53	B45-6721D	60.45
9847683	RH Twisted	N/A	B45-6720D	15.53	B45-6720D	62.31

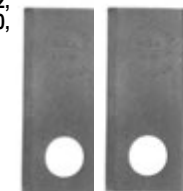

DISC MOWER KNIVES - 18 DEGREE TOP BEVEL

Fits NEW HOLLAND 3204, 3205, 3260, 3309

Length: 4.79" Degree of Twist: 18 Hole Diameter: .89
Width: 1.88 Thickness: 0.165 Center Of Hole To Back Edge: .78

OEM Number	Style	Shape	Bolt Order No	6 Blades Order No	List
113385A1	5	LH Twisted	B55-0355D	B45-6576D	15.50
113384A1	5	RH Twisted	B55-0355D	B45-6577D	15.50

**HOLD DOWN CLIPS
NON-ADJUSTABLE**

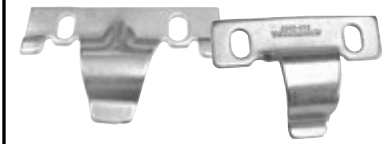

Fits NEW HOLLAND Bolted sickles with head clearance. Steel.

Style	Order No.	List
Low Arch	C45-0692	5.55
High Arch	C45-0693	7.45



Fits NEW HOLLAND Windrowers with guard G81-0120. Steel.

Style	Order No.	List
Low Arch	C45-0502	9.33
High Arch	C45-0503	14.18



Fits VERSATILE with riveted sickles. Steel. Hardened.

Style	Order No.	List
Low Arch	C45-0419	5.25



Fits VERSATILE with bolted sickles. Steel. Hardened.

Style	Order No.	List
Low Arch	C45-0951	7.23

1-YEAR WARRANTY ON ALL ITEMS!

DISC MOWER KNIVES - 18 DEGREE BOTTOM BEVEL

Fits NEW HOLLAND 725, 8850, DC515, 8309, 8312, 8315

Length: 4.21"	Degree of Twist: 18	Hole Diameter: .73
Width: 1.88	Thickness: 0.163	Center Of Hole To Back Edge: .78

OEM Number	Shape	Bolt Order No	6 Blades Order No	List	25 Blades Order No	List
700715575	LH Twisted	B55-0342D	B45-6572D	16.74	B45-6572	60.96
700715576	RH Twisted	B55-0342D	B45-6573D	16.74	B45-6573	60.96

DISC MOWER KNIVES - 18 DEGREE TOP BEVEL

Fits NEW HOLLAND 725, 8850, DC515, 8309, 8312, 8315

Length: 4.21"	Degree of Twist: 18	Hole Diameter: .73
Width: 1.89	Thickness: 0.157	Center Of Hole To Back Edge: .75

OEM Number	Shape	Bolt Order No	6 Blades Order No	List	25 Blades Order No	List
700715575	LH Twisted	B55-0342D	B45-6725D	17.95	B45-6725	62.31
700715576	RH Twisted	B55-0342D	B45-6726D	17.95	B45-6726	62.31

GRASS BOARD

Fits all mowers.

Order No	List
B52-0615	67.69



WEAR PLATES



For all NEW HOLLAND Mowers, Swathers, Combines. Replaces W50, 141021. 5-7/8" long. Slotted holes with 3" spacing.

Order No.	List
P44-0591	3.33
P44-0591D*	12.02

*Display Pack of 2.



For all NEW HOLLAND Combines with floating bars. 6" full length. Replaces 271967, 26616.

Order No.	List
P44-0417	3.00



24" length with 1-1/2" spacing. Heat treated. Replaces FLW24HT.

Order No.	List
P44-0200	17.71

RAKE WHEELS

Heavy Duty, .275. Fits Sitrex, Case, H&S, M&W, New Holland, Westward & Others. Painted Creme Overall diameter: 55"

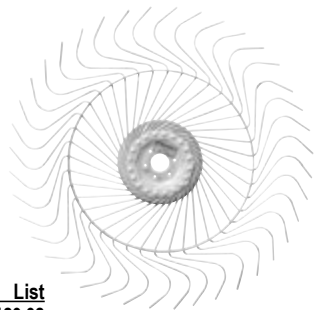

Description	Order No	List
Right Hand	W16-0801	180.08
Left Hand	W16-0802	180.08

Replacement Tine Part Number T16-0815D.

RAKE WHEELS

Fits New Holland Procart 819, 1022, 1225; Duravee 817, 1020, 1225*, 1428, 1631*, 1833, 2036, H5920, HT152, HT154, P1225P*, P1428P* and others using 55" Diameter wheels. *Confirm wheel diameter prior to ordering.

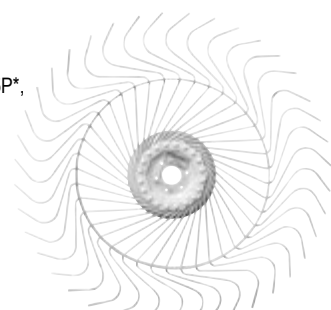

Color: New Holland Yellow
Diameter: 55"
Bolt Pattern: 5-1/4"
Pilot: 3-3/16"
Bolts: Accepts 10mm or 7/16"

Part #	Description	List
W16-0814	RH Rake Wheel 55" New Holland Yellow	180.08
W16-0815	LH Rake Wheel 55" New Holland Yellow	180.08

HOLD DOWN CLIPS ADJUSTABLE

Fits most NEW HOLLAND Mowers, Conditioners and Swathers except Verstile. Cast.



Style	Order No.	List
Low Arch	C45-0006	37.80
High Arch	C45-0007	37.80

Fits most NEW HOLLAND Combines, Mowers and Windrowers except Versatile, Hart-Carter & Love. Stamped



Style	Order No.	List
Low Arch	C45-0040	9.05

HUB ASSEMBLY

With bearing for all wheels listed at left. Pilot: 3.21". Bolt circle: 5.12". 13mm bolt required



Order No.	List
H16-1000	76.86

RAKE WHEEL SPRING

Fits H&S and other Wheel Rakes using lift springs on wheels. 1 used per hay turning wheel. 11" long. 1-7/8" OD. 1-1/2" ID .238 Diameter wire



Order No.	List
S16-1000	22.57

BALE COUNTER

Bale counter, reads up to 99,999. 4-hole mounting plate, push button reset, adjustable side arm. Fits most balers.

Order No	List
T55-0002	30.62





RUBBER MOUNT RAKE TOOTH

For JOHN DEERE Rakes 640, 650, 660, 670, 672, 662, 652, 896A. Replaces 1/4 x 3/4 LPK, RMT-1, AE47389. Right hand.

Order No.	List
T16-0182	3.15



RIGHT HAND RAKE TOOTH

For NEW HOLLAND Rakes 56B, 27, 259, 216, 256, 258, 260, 269 & 216. Replaces 130941R.

Order No.	List
T16-0166	4.74



LEFT HAND RAKE TOOTH

For NEW HOLLAND Rakes 216, 258, 259, 260. Replaces 65668L.

Order No.	List
T16-0154	4.97



RAKE TOOTH

For NEW HOLLAND Rakes 55, 56B, 57, 256, 258, 259, 260. Replaces 64562. Left hand rakes.

Order No.	List
T16-0370	2.64

Clip for T16-0370. 10 per bag.

Order No.	List
C45-0493B	10.82

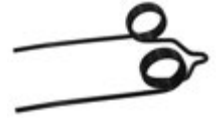

RAKE TOOTH

For FORD Rakes. Replaces 146545.

Order No.	List
T16-0340	5.77

Get Online With Herschel Parts!

HERSCHELPARTS.com

You can shop 24 hours a day. 7 Days A Week!



REEL TOOTH

For NEW HOLLAND Mower Conditioners and Windrowers 460, 461, 467, 468, 472, 474, 488, 492, 903, 907, 909, 912, 1100, 1112, 477, 479. Replaces 76517.

Order No.	List
T16-0032	4.96



BALER TOOTH

For NEW HOLLAND Pickup on Super Sweep Baler & Large Round Balers. Replaces 131673, 86551419.

Order No.	List
T16-0162	3.98



BALER TOOTH

For NEW HOLLAND Balers 78 & Super 68, 273, 276. Replaces 127566.

Order No.	List
T16-0158	3.39

- PATENTED 2 PIECE DESIGN.
- SAVE MONEY!
REPLACE ONLY THE TINE.



HERSCHEL 6" 2-PIECE POLY TINES FOR PIPE REELS

Fits NEW HOLLAND 71C, 73C, 972 & 973. 1/2" Nub.

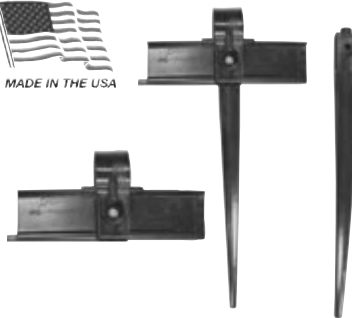

Description	Pkg. Qty.	Order No	List
Tine & Clamp	100/Box	T16-0740	233.22
Tine & Clamp	10/Box	T16-0745	25.00
Tine ONLY	100/Box	T16-0750	150.24

NYLON FLEX TINE

For New Holland Reel-bat-tine with wood bats. Replaces N66A. 1 mounts to front of bat. 100 per box.

Order No.	List
T16-0183	225.49

NYLON FLEX TINE

For New Holland Reel-bat-tine. Replaces N67A. 100 per box.

Order No.	List
T16-0767	190.20

1-YEAR WARRANTY ON ALL ITEMS!



2 PIECE M/L REEL TINE

Replaces 782551, 1989438C1, AH136689, AH153175. 100 per box. 3/8" Nub.

Order No.	List
T16-0720	251.62



2 PIECE M/L REEL TINE

Replaces 782226, 1989438C1, AH136689, AH153175. 10 per bag. 3/8" Nub.

Order No.	List
T16-0715	23.22



M/L REEL TINE

For T16-0715 and T16-0720. No clamps. Replaces HA100MLT. 100 per box. 3/8" Nub.

Order No.	List
T16-0725	147.75

HAMMER RIVET TOOL

For Drive Rivets

Order No.	List
T55-0812	30.71



NEW IDEA

HERSCHEL sections are made in the USA from high quality boron steel. Heat-treated for long life. Sections are extra heavy (.116") and chrome unless stated otherwise.

SECTION TYPES

7TS = Super 7® Top Serrated
 SM = Smooth
 US = Under Serrated - 14 Tooth
 TS = Top Serrated - 14 Tooth
 TT = Tiger Tooth
 TJ = Tiger Jaw
 SRK = Tiger Shark™



SECTION - XHSM

Fits NEW IDEA Mowers and Conditioners. Section is 3" x 3-1/4". Use 9/16 OH Rivet. Sold 10 sections per pack. M333-1/2.

Replaces		
Number	Order No	List
0577HS	S20-1145	19.48



SECTION - XHTSCR

Fits NEW IDEA Mowers and Conditioners. Section is 3" x 3-1/4". Use 5/8 OH Rivet. Sold 10 sections per pack.

Replaces		
Number	Order No	List
714604	S20-4719	27.87



SECTION - XHUSCR

Fits NEW IDEA Mowers and Conditioners. Section is 3" x 3-1/4". Use 9/16 OH Rivet. Sold 10 sections per pack.

Replaces		
Number	Order No	List
0188HS	S20-6339	20.60



SECTION - XHUS

Fits NEW IDEA Mowers and Conditioners. Section is 3" x 3-1/4". Use 9/16 OH Rivet. Sold 10 sections per pack.

Replaces		
Number	Order No	List
OU577HS	S20-5107	16.38

Get Online With Herschel Parts!

HERSCHELPARTS.com

You can shop 24 hours a day.
7 Days A Week!



7' RIVETED SICKLE - XHUS SECTIONS

Fits NEW IDEA Mowers 10, 20, 30, 40, 41, 250, 251, 252, 253, 254, 255.

Section OEM# OU577HS
Head OEM# 05H

OEM #	# of Sections	Order No	List
OU286HSA	28	S35-3536	272.93



9' RIVETED SICKLE - XHUS SECTIONS - HEADLESS

Fits NEW IDEA Mower Conditioners 290.

Section OEM# OU577HS

OEM #	# of Sections	Order No	List
290627S	35	S35-3620	183.67



RIVETED SICKLES - XHUS SECTIONS

Fits NEW IDEA Mower Conditioners 507, 5107, 509, 5109.

Section OEM# OU577HS
Head OEM# 824594C1

OEM #	Length	# of Sections	Order No	List
101987C91	7'	28	S35-3293	504.13
101988C91	9'	36	S35-3292	410.60



S35-3668/3669

RIVETED SICKLES

Fits NEW IDEA Mowers 521 & 522.

Section OEM# 826724C2
Head OEM# 56692C91

OEM #	Length	# of Sections	Order No	List
462381R93	7'	28 - XHSM	S35-3668	205.43
		Tiger Shark™	S35-2500	210.68
463182R93	9'	36 - XHSM	S35-3672	183.83
463159R93	9'	36 - XHUS	S35-3669	169.57
		Tiger Shark™	S35-2512	198.12

WHY TRY TIGER SHARK™ SECTIONS?

1. Serrated teeth allow more cutting surface.
2. They last longer, cut faster.
3. Cuts equally well in soybeans, alfalfa, grass hay, wheat, etc.



Customer Testimonial:

"I cut over 1000 acres of soybeans with the same *Herschel Tiger Shark™* sections. They stayed sharper longer and lasted longer than any section I have used." - Roger Woodruff, Warren Co. Iowa



12-1/4' RIVETED SICKLE - XHUSCR SECTIONS

Fits NEW IDEA Mower Conditioner 512

Section OEM# O1188HS
Head OEM# ZA502562

OEM #	# of Sections	Order No	List
BN502825	48	S35-2293	452.16



14-1/4' RIVETED SICKLE - XHUSCR SECTIONS

Fits NEW IDEA Mower Conditioner 514

Section OEM# O1188HS
Head OEM# ZA502562

OEM #	# of Sections	Order No	List
BN502826	56	S35-2294	470.24

**1-YEAR
WARRANTY ON
ALL ITEMS!**

SICKLE HEADS



Fits NEW IDEA Mower Con-
ditioners 512, 514. Replaces
ZA502562.

Fits NEW IDEA Mowers 521,
522. Replaces 462378R11.

Order No.	List
H15-0292	111.84

Order No.	List
H15-0281	72.35

MALLEABLE GUARDS

G81-0803

Fits 7/16" Bars.

Replaces	Description	Order No	List
DM700, 25314	Center Guard	G81-0803	8.24

Fits all NEW IDEA Mowers 521 & 522.

Replaces	Description	Order No	List
MC2041Z	Center Guard	G81-0830	14.85



RAKE TOOTH

For NEW IDEA Rake 404
Wheel Type. Replaces 400033,
0633ME, 782ME. 50 per box.



Order No.	List
T16-0368	6.38



RAKE TOOTH

For NEW IDEA Rakes 49, 400,
402, 403. Replaces 400341.

Order No.	List
T16-0370	2.64

Clip for T16-0370. 10 per bag.

Order No.	List
C45-0493B	10.82

FORGED STEEL GUARD

Fits NEW IDEA Mowers 521 & 522.
Replaces FS65-2, HA270.



Order No	List
G81-0035	17.77

FORGED STEEL GUARD

Fits NEW IDEA Mowers 521 & 522.
Replaces FS66-2, HA240A, 714611.



Order No	List
G81-0191	13.40

DISC MOWER KNIVES

Fits NEW IDEA 5209, 5212, 5312, 5406, 5407, 5408, 5408, 5410

Length: 4.76"	Degree of Twist: 13	Hole Diameter: .89
Width: 1.88	Thickness: 0.165	Center Of Hole To Back Edge: .78

OEM Number	Style	Shape	Bolt Order No	6 Blades Order No	List	25 Blades Order No	List
527746	5	RH Twisted	B55-0355D	B45-6563D	16.05	B45-6563	62.90
527747	5	LH Twisted	B55-0355D	B45-6564D	16.05	B45-6564	62.90



FORGED STEEL GUARD

Fits NEW IDEA Com-
bine Uni Harvester
Header No 815 thru
820. Replaces FS66-
DH, HA245DH Double
Heat Treated.



Order No	List
G81-0042	18.96

DISC MOWER KNIVES - 13 DEGREE TOP BEVEL

Fits NEW IDEA 5209, 5212, 5406, 5407, 5408, 5409, 5410, 526, 527, 528

Length: 4.72"	Degree of Twist: 13	Hole Diameter: .73
Width: 1.86	Thickness: 0.163	Center Of Hole To Back Edge: .78

OEM Number	Style	Shape	Bolt Order No	6 Blades Order No	List	25 Blades Order No	List
526216	5	LH Twisted	B55-0357D	B45-6992D	16.91	B45-6992	63.76
526215	5	RH Twisted	B55-0357D	B45-6993D	16.91	B45-6993	63.76



FORGED STEEL GUARD

Fits NEW IDEA Com-
bines 71, 713, 715. Re-
places FC90-2, HA240A,
714611, HA245. Center
guard.



Order No	List
G81-0192	13.29

DISC MOWER KNIVES - 13 DEGREE TOP BEVEL

Fits Case-IH 5070, 5512, 5515, 6070

Length: 4.21"	Degree of Twist: 13	Hole Diameter: .72
Width: 1.78	Thickness: 0.169	Center Of Hole To Back Edge: .80

OEM Number	Style	Shape	Bolt Order No	6 Blades Order No	List	25 Blades Order No	List
700712888	4	RH Twisted	B55-0344D	B45-6568D	15.03	B45-6568	59.94
700712889	4	LH Twisted	B55-0344D	B45-6569D	15.03	B45-6569	59.94



Length: 4.21"	Degree of Twist: 13	Hole Diameter: .73
Width: 1.86	Thickness: 0.175	Center Of Hole To Back Edge: .78

OEM Number	Style	Shape	Bolt Order No	6 Blades Order No	List	25 Blades Order No	List
	5	RH Twisted	B55-0342D	B45-6559D	14.35	B45-6559	57.98
	5	LH Twisted	B55-0342D	B45-6560D	14.35	B45-6560	57.98



OWATONNA/PRAIRIE STAR

HERSCHEL sections are made in the USA from high quality boron steel. Heat-treated for long life. Sections are extra heavy (.116") and chrome unless stated otherwise.

SECTION TYPES

7TS = Super 7® Top Serrated TT = Tiger Tooth
 SM = Smooth TJ = Tiger Jaw
 US = Under Serrated - 14 Tooth SRK = Tiger Shark™
 TS = Top Serrated - 14 Tooth



SECTION - XHTSCR

Fits OWATONNA/PRAIRIE STAR Windrowers 180, 196, 197, 200, 206, 262, 265, 270, 275, 280, 282, 281, 285. Section is 3" x 3-1/4". Uses 1/2 OH rivet. Sold 10 sections per pack. Replaces 340-16457.

Order No	List
S20-4277	23.83



SECTION - XHTTCR

Fits OWATONNA/PRAIRIE STAR Windrowers 180, 196, 197, 200, 206, 262, 265, 270, 275, 280, 282, 281, 285. Section is 3" x 3-1/4". Uses 5/8 OH rivet. Sold 10 sections per pack. Replaces TT049254.

Order No	List
S20-4639	27.29

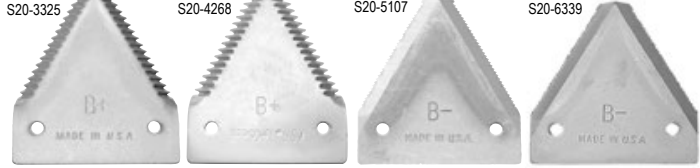

SECTIONS

Fits OWATONNA/PRAIRIE STAR Windrowers 180, 196, 197, 200, 206, 262, 265, 270, 275, 280, 282, 281, 285. Section is 3" x 3-1/4". Uses 5/8 OH rivet. Sold 10 sections per pack.

OEM

Number	Application	Design	Order No.	List
SS340-32015	XH7TS	B+	S20-3325	16.31
SS340-32015CR	XH7TSCR	B+	S20-4268	19.51
340-32049	XHUS	B-	S20-5107	16.38
340-32049 CR	XHUSCR	B-	S20-6339	20.60

SICKLES - HEADLESS

Fits OWATONNA/PRAIRIE STAR WINDROWERS 208, 216, 229, 235, 255, 260, 265, 270, 275, 280, 282, 285, 281, 800, 900, 2650, 2240, 2270.

OEM #	Length	# of Sections	Section OEM #	Bolted Order No	List
340-32020	14'	57 - XHTS	340-32015	S35-1162	262.49



BOLTED SICKLES - XH7TSCR SECTIONS HEADLESS

Fits MACDON WINDROWERS AND DRAPERS.

Section OEM# SS34390CR

OEM #	Length	Order No	List
33704	18'	S35-2262	464.45
43074	21'	S35-2253	461.04
43076	4' Ext., use w/S35-2253	S35-2254	239.23
43077	9' Ext., use w/S35-2253	S35-2255	345.71

GUARD

Raised Trash Bar. Fits OWATONNA/PRAIRIE STAR Windrowers and Mower Conditioners. Replaces OEM 110-32327, 110-32342, FS92-2.

Order No	List
G81-0140	26.09

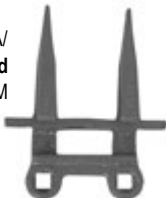

GUARD BOLT- 1/2" X 1-1/2"

No. 3 Head (N/C Black) Gr. 5 Hardened (With Nuts). Use with guard 110-10657. Replaces 030-10659, 030-10642. 50 bolts/nuts per package.

Order No	List
B55-0295	16.99



HERSCHEL sections are made in the USA from high quality boron steel. Heat-treated for long life. Sections are extra heavy (.116") and chrome unless stated otherwise.

SECTION TYPES

7TS = Super 7® Top Serrated
 SM = Smooth
 US = Under Serrated - 14 Tooth
 TS = Top Serrated - 14 Tooth
 TT = Tiger Tooth
 TJ = Tiger Jaw
 SRK = Tiger Shark™



SECTION - XHUS
 Fits ROWSE Mowers. Section is 3" x 3-1/4". Use 9/16 CS Rivet. Sold 10 sections per pack.

Replaces
Number **Order No** **List**
 M22831, S20-5107 16.38
 29875





SECTION - XHSM
 Fits ROWSE Mowers. Section is 3" x 3-1/4". Use 9/16 CS Rivet. Sold 10 sections per pack.

Replaces
Number **Order No** **List**
 M3331/2 S20-1145 19.48

SICKLE HEAD
 Fits ROWSE CURRENT MOWERS.
 Replaces 143603.

Order No	List
H15-0208	100.56



SICKLES
 Fits ROWSE CURRENT MOWERS.

Section OEM# 29875
 Head OEM# 143603

OEM #	Length	# of Sections	Riveted		Bolted	
			Order No	List	Order No	List
228435	7'	29 - XHUS	S35-3884	165.87		
228434	9'	35 - XHUS	S35-3885	208.53	S35-1704	261.43
4BN228434		Tiger Shark™	S35-2552	244.97		

SICKLE HEAD
 Fits ROWSE OLDER MOWERS.
 Replaces 462378R11.

Order No	List
H15-0281	72.35

SICKLES
 Fits ROWSE OLDER MOWERS.

Head OEM# 462378R1

OEM #	Length	# of Sections	Section OEM	Riveted		Bolted	
				Order No	List	Order No	List
462381R91	7'	28 - XHSM	M3331/2	S35-3668	205.43		
462380R91,	7'	28 - XHUS	M22831	S35-3667	159.22	S35-2500	210.68
BN462380R91		Tiger Shark™				S35-1281	227.39
463182R91	9'	35 - XHSM	M3331/2	S35-3672	183.83	S35-2500	210.68
463159R91,	9'	35 - XHUS	M22831	S35-3669	169.57	S35-1714	217.07
BN463159R91		Tiger Shark™				S35-2512	198.12

FORGED STEEL GUARD
 Fits ROWSE CURRENT MOWERS. Replaces 219190, FS93-2, BU218, FS93-2DH, HA216, HA216DH.

Order No	List
G81-0184	15.81
G81-0144 - Double Heat Treat	17.43



FORGED STEEL GUARD
 Fits ROWSE OLDER MOWERS. Replace FS65-2, HA270.

Order No	List
G81-0035	17.77



SICKLE
 Fits ROWSE OLDER MOWERS.

Head OEM# 56992C91

OEM #	Length	# of Sections	Riveted		Bolted	
			Order No	List	Order No	List
1281291C29	9'	35 - XHTS	S35-3940	167.95	S35-1103	215.81

HERSCHEL sections are made in the USA from high quality boron steel. Heat-treated for long life. Sections are extra heavy (.116") and chrome unless stated otherwise.

WHY TRY TIGER SHARK™ SECTIONS?

1. Serrated teeth allow more cutting surface.
2. They last longer, cut faster.
3. Cuts equally well in soybeans, alfalfa, grass hay, wheat, etc.



Customer Testimonial:

I cut over 1000 acres of soybeans with the same *Herschel Tiger Shark™* sections. They stayed sharper longer and lasted longer than any section I have used. - Roger Woodruff, Warren Co. Iowa



S20-8498 S20-4498 S20-3513

SECTIONS

Fits SCHUMACHER Heads with Easy Cut System. Sold 10 sections per pack.

The *Tiger Shark™* section can be used in place of the sections listed below.

OEM #	Description	Order No	List
	Tiger Shark™	S20-8498	19.51
26208CR, 420-100-058	XH7TSCR	S20-4498	19.51
420-100-058	XH7TS	S20-3513	24.35

SECTION TYPES

- | | |
|--------------------------------|--------------------|
| 7TS = Super 7® Top Serrated | TT = Tiger Tooth |
| SM = Smooth | TJ = Tiger Jaw |
| US = Under Serrated - 14 Tooth | SRK = Tiger Shark™ |
| TS = Top Serrated - 14 Tooth | |

SECTION BOLT/NUT

Replaces 420100012, 61711. M6-1.0x16. 50 per package.



Order No.	List
B55-0075D	29.40

SECTION FLANGE NUT

Replaces 01106001, 61713. 20 per package. M6-16



Order No.	List
N83-0075D	9.62



SPLICE KIT

Order No.	List
C83-0500	26.70

SPliced SICKLES FOR SCHUMACHER EASY CUT SYSTEMS

Sickles are headless



SICKLES WITH SUPER 7® SECTIONS(CHROME)

Section Type	Size	# of Sections	Order No.	List
H7TSCR	20	82	S35-2520	525.71
H7TSCR	25	102	S35-2525	653.96
H7TSCR	30	122	S35-2531	779.17
H7TSCR	35	142	S35-2535	901.36
XH7TSCR	36'	146	S35-2544	926.73
XH7TSCR	40'	146	S35-2546	978.60

SICKLES WITH TIGER SHARK™ SECTIONS(CHROME)

Section Type	Size	# of Sections	Order No.	List
XHSRKCR	30	122	S35-2637	779.17
XHSRKCR	36	146	S35-2638	926.73

12MM GUARD

Fits ROWSE AG-CO-Gleaner Series 3, 300-8200; Challenger, JD Quik-Tack, 200, 900, 900 R&F, Honey Bee, New Holland 88C, 92C, 94C. Replaces 10616.10, 16500.10.



Order No	List
G81-0201	18.67

17MM GUARD

Fits Case IH 820, 1020. Replaces 10618.10, 16502.10.



Order No	List
G81-0202	20.99

1-YEAR WARRANTY ON ALL ITEMS!

HERSCHEL sections are made in the USA from high quality boron steel. Heat-treated for long life. Sections are extra heavy (.116") and chrome unless stated otherwise.



SECTIONS

Fits TRIUMPH MOWERS. Section is 3" x 3-1/4". Uses 9/16 OH rivet. Sold 10 sections per pack.

OEM

Number	Application	Design	Order No.	List
646	XH US	A-	S20-5246	17.41
1227	XH SM		S20-1142	20.47
SSBKE45996	XH7TS	A+	S20-3407	17.27
982752	XH7TS CR	A+	S20-4286	19.87



6' SICKLES

Fits TRIUMPH MOWERS AND HYDRO-CLIPPER.

Head OEM# 1874.

OEM #	# of Sections	Section OEM	Riveted		Bolted	
			Order No	List	Order No	List
1876	24 - XHUS	M646	S35-3062	208.94		
SS1876BN	24 - XH7TS	SSBKE45996			S35-1077	262.78
BN1876CRSS	24 - XH7TSCR	SSE45996			S35-2924*	221.91

* Note: Special Order Item. Minimum quantities may be required

SECTION TYPES

7TS = Super 7® Top Serrated
 SM = Smooth
 US = Under Serrated - 14 Tooth
 TS = Top Serrated - 14 Tooth
 TT = Tiger Tooth
 TJ = Tiger Jaw
 SRK = Tiger Shark™



SICKLE HEAD

Fits TRIUMPH MOWERS AND HYDRO-CLIPPER. REPLACES 1874.

Order No.	List
H15-0288	72.13

PITMAN STRAP - FRONT

Fits TRIUMPH MOWERS

Replaces	Order No	List
MA1577	S78-0834	89.93



PITMAN STRAP - REAR

Fits TRIUMPH MOWERS

Replaces	Order No	List
M1578	S78-0835	95.12



GUARD BOLT

#3 Plow bolt. 7/16" x 1-1/2".

Qty	Order No	List
50	B55-0260	33.96
10	B55-0260D	11.47



GUARD BOLT

#3 Plow bolt. 7/16" x 1-3/4".

Qty	Order No	List
50	B55-0265	28.02
10	B55-0265D	11.47



HOLD DOWN CLIP ADJUSTABLE

Fits most TRIUMPH MOWERS. Steel. Low Arch

Order No.	List
C45-0040	9.05

BALER IDLER BEARING

Fits VERMEER C, F, G, H, I, J, K, L, XL, Rebel Series. 1-1/2" Spherical w/collar

Replaces Number	Order No	List
212-001	H212001	37.30

BALER UPPER DRIVE BEARING

Fits VERMEER K, L, XL Series. 1-15/16" Spherical 4 Bolt

Replaces Number	Order No	List
110457-003	H110457003	26.42

BALE TOOTH

For VERMEER B & C Balers. Replaces F-413/48893001. .187 Wire. 100/Case. Yellow.

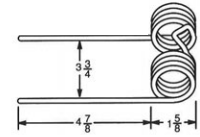

Order No.	List
V-1	4.88

BALER HAY SAVER BEARING

Fits VERMEER G, H, I, J, K, L, XL, M Rebel Series. 1-1/2" Cylindrical w/collar.

Replaces Number	Order No	List
4051-001	H4051001	16.09

RUBBER MOUNT RAKE TOOTH

For VERMEER R9, R21, R23, R23A, R24, R24A, R2300. Replaces EF2888001, AE56204. Right/Left hand. 1-5/8" inside saddle width, centered mounting holes. 100/box.



Order No.	List
T16-0185	5.07

BALE TOOTH

For VERMEER D Series Baler. Replaces F-1326/29-001. .187 Wire. 100/Case. Yellow.

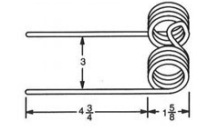

Order No.	List
V-2	4.88

BALER PICKUP DRIVE BEARING

Fits VERMEER I, J, K, L, XL, M, Rebel Series. 1-1/4" Spherical w/collar.



Replaces Number	Order No	List
4052-001	H4052001	22.82
502289-001		

RUBBER MOUNT RAKE TOOTH

For VERMEER R2800 Rakes. Replaces 510501250. .276" wire diameter. 3/8" whole diameter. 1-7/8" saddle. 9-1/2" long. 100/box.



Order No.	List
T16-0189	5.80

BALE TOOTH

For VERMEER Round Balers E, F, G Series. Replaces 4059-001. Spring. 100 per box. .207 wire.



Order No.	List
T16-0485	4.47

SPRING TOOTH

For VERMEER Super F, G, H, I, J, K, L, XL & Rebel Series. 150, 1450, 504, 505/5410, 5410, 550. Replaces 4000-997, 27997-001. 50 per box. 7"



Order No.	List
T16-0488	7.58

LOOKING FOR POLY BALER PICKUP BANDS?

See Page 114.

BALER POLY PICKUP BAND

For VERMEER Round Baler I, Super I, J, Super J, K, L, XL, Super M, N, Rancher, Rebel. Replaces 89982001.



Order No.	List
H89982001	43.18

DISC MOWER KNIVES

Fits VERMEER 230, 275, 320

Length: 3.66"	Degree of Twist: 13	Hole Diameter: .64
Width: 1.60	Thickness: 0.116	Center Of Hole To Back Edge: .80

OEM Number	Style	Shape	Bolt Order No	6 Blades Order No	List	25 Blades Order No	List
DM303	4	LH Twisted	B55-0358D	B45-6996D	15.56	B45-6996	46.70
DM304	4	RH Twisted	B55-0358D	B45-6997D	15.56	B45-6997	54.42

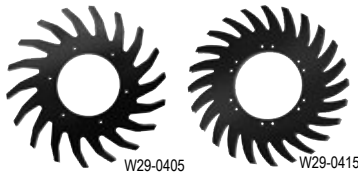

GATHERING WHEEL

Wheels provide the reliable performance you expect from OEM quality gathering wheel. Bolt holes are pre-punched for ease of installation and offered pattern fits most balers equipped for this wheel style.

GATHERING WHEELS

Unique blend of rubber compounds offering durability and performance. The tough rubber fingers resist breakage and provide a longer service life

Model	Description	Order No.	List
504 I, 504 L, 504 SI, 505 I, 504 SI, 554 XL, 555 XL, 604 J, 604 K, 605 J, 605 K, 604 L, 605L, 605 SJ, 604 SJ, 604 XL, 605 XL, 5400 Rebel, 5410 Rebel, 5420 Rebel, 5500 Rebel, 5520 Rebel, 540 M Classic, 664 Rancher, 665 Rancher, 6640 Rancher, 6650 Rancher	24" x 9" Gathering Wheel	W29-0405	171.98
504 F, 504 G, 504 H, 605 F, 605G, 605H	28" x 12" Gathering Wheel	W29-0415	219.76

RAKE WHEELS

Heavy Duty, .276" (7mm). Overall diameter: 55"

Description	Order No.	List
Right Hand. P20BG003	W16-0805	180.08
Left Hand. P20BG004	W16-0806	180.08
Replacement Tine: T16-0497.		

Heavy Duty, .276" (7mm). Painted Creme Overall diameter: 55"

Description	Order No.	List
Right Hand. P20BG003	W16-0811	180.08
Left Hand. P20BG004	W16-0812	180.08
Replacement Tine: T16-0497.		

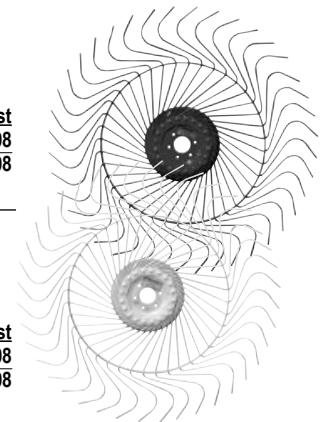

BOLTED SICKLES - HEADLESS XH7TSCR SECTIONS
Fits WHITE 6400 WINDROWER WITH DRAPER HEADER



Section part number is S20-4398, OEM# SS34390CR.

OEM #	Length	#of Sections	Order No	List
33704	18'	71	S35-2262	464.45
43074, 338616A1	21'	83	S35-2253	461.04
43076, use w/ S35-2253	4' EXT	16	S35-2254	239.23
43077, use w/ S35-2253	9' EXT	36	S35-2255	345.71

RAKE TOOTH

Fits No. 5 Rake. Replaces 64562. Mfr: Minnesota.



Order No.	List
T16-0370	2.64

BOLTED SICKLES - HEADLESS XHTSCR SECTIONS
Fits WHITE COMBINES WITH KWIK CUT SYSTEM

Size	Description	Order No	List
13' & 15'	Universal 2-point Tiger Jaw sickle	S35-2154	457.84
18' & 20'	Universal 2-point Tiger Jaw sickle	S35-2156	554.90
4'	4' Extension, use with S35-2156	S35-2271	107.59



COMBINE PICKUP REEL
For WHITE Hume reels. Replaces 1127024. Steel. 100 per box.

Order No.	List
T16-0124	1.90



NYLON FLEX TINE
Replaces N66A. 1 mounts to front of bat. 100 per box.

Order No.	List
T16-0183	225.49



NYLON FLEX TINE
Replaces N67A. 1 mounts to rear of bat. 100 per box.

Order No.	List
T16-0767	190.20

FORGED STEEL GUARD
Fits WHITE COMBINES WITH FLOATING BARS W/GROOVE. Replaces 31-2749417, FC89-2 and HA231, BU231.



Order No	List
G81-0125	22.87

FORGED STEEL GUARD
Fits WHITE WINDROWERS 501, 502, 503. Replaces 895744L, FS73-2, HA235.



Order No	List
G81-0070	19.03

FORGED STEEL GUARD
Fits WHITE COMBINES WITH RIGID BARS. Replaces 9510220, HA240, BU240.



Order No	List
G81-0191	13.40



2 PIECE M/L REEL TINE
Replaces 782551, 1989438C1, AH136689, AH153175. 100 per box.

Order No.	List
T16-0720	251.62



2 PIECE M/L REEL TINE
Replaces 782226, 1989438C1, AH136689, AH153175. 10 per bag.

Order No.	List
T16-0715	23.22



M/L REEL TINE
For T16-0715 and T16-0720. No clamps. Replaces HA100MLT. 100 per box.

Order No.	List
T16-0725	147.75

SECTION BOLTS

- Quick and easy section changes are possible with bolts.
- No more cutting, chiseling, or grinding - simply unbolt the section, replace and tighten bolts.
- Bolts will not turn in Knife Back and are reusable. They will last thru the life of several sections.
- Bolts may be replaced easily if accidentally damaged or broken.
- No special tools are needed to change sections, only a 7/16 wrench or socket.
- Bolt and nuts hold better than rivets and they have a greater clamp load than rivets.
- Special lock nuts will not vibrate loose.

Description	Application	Pkg.	Qty. Mst Ctn.	Order No	List
Section Bolt w/nut	Universal - Replaces 9/16 & 5/8 OH Rivets	50	300	B55-0065D	12.28
Head Bolt w/nut	Universal - Replaces 1-1/2 & 1-1/16 OH Rivets. 1" long.	15	90	B55-0085D	7.31
Head Bolt w/nut	Universal - Replaces 1-1/2 OH Rivets. 1-21/64" long.	12	72	B55-0095D	7.51
Head Bolt w/nut	Case I-H Combines 1010 & 1020, 1-1/2 System**. Oval Head.	16	96	B55-0060D	32.33
Section Bolt w/nut	Universal Bolts for 10' Sickle w/Head Bolts (80-B55-0065D, 5-B55-0085D, 5-B55-0095)	90	Each	B55-0500D	28.42
Overlap Bolt w/Low Profile Nut*	Double Drive Sickles, replaces 1/2 CS rivets 60° Head	10	60	B55-0059D	9.40
Section Bolt*	Versatile, Countersink, replaces 9/16 CS rivets	20	120	B55-0056D	13.52
Section Bolt*	Love & Hart Carter, Countersink, replaces 5/8 CS rivets. 60° Head	20	120	B55-0057D	6.31
Head Bolt*	Love, Hart Carter & Versatile, Countersink, replaces 1 CS rivets	10	6	B55-0058D	10.68
5/8" Section Bolt w/nuts	Versatile, Windrower 4400, 2400, 2800	20	120	B55-0955D	10.02
90° CSK, Oval Shoulder					
7/8" Head Bolt w/nuts;	Versatile, Windrower 4400, 2400, 2800	10	60	B55-0975D	4.80
90° CSK, Oval Shoulder					
1" Ribbed Bolts & Nuts;	Versatile	25	150	B55-0971D	No
Match!					
60° CSK					
Nut	Universal-Used on all the above bolts except B55-0050D	20	120	N83-0289D	6.70
Low Profile Nut	Overlap Area on Dbl. Drives & Case/IH 1020 1-1/2" Systems	20	120	N83-0295D	6.90

* Use with Allen Wrench ** Requires IH Hold Down OEM#132074663



BALER SHEAR BOLTS

Designed to meet OEM specifications. All bolts are grade 5, plain finish except where noted. Pkg. of 10 bolts with nuts.

Description	Order No.	List
New Holland 5/16-18 x 2" Hex Head.	B55-0551D	18.60

SECTION RIVETS - ZINC PLATED

OH = Oval Head CS = Counter Sunk

Size/No. in Pkg.	Application	Qty. Pkg.	Mstr. Ctn.	Order No	List
5/8" # 5-1/2 (56)	7" Heavy Mower Sections and Knife Heads	Asst.	6	R36-0523D	10.70
1" # 5-1/2 (10)	Mower Conditioners	Asst.	6	R36-0524D	12.31
5/8" # 5-1/2 (72)					
1" # 5-1/2 (5)					
1-1/4" # 5-1/2 (5)					
5/8" OH #5-1/2	Heavy Gauge Sections	1#	6#	R36-0462D	16.74
15/16" OH #5-1/2	Head Rivet	1/2#	3#	R36-0522D	9.11
1-1/4" OH #5-1/2	Head Rivet	1/2#	3#	R36-0467D	8.53
5/8" CS #5-1/2	Section Rivet	1#	6#	R36-0463D	13.66
1-1/4" CS #5-1/2	Guard Plate Rivet	1/2#	3#	R36-0468D	8.28
9/16" (1 lb./BB)	CS Rivets Zinc Plt. Primarily used on Rice Cutterbars	1#	6#	R36-0469D	14.10



GRASS BOARD

Fits all mowers.



Order No	List
B52-0615	67.69

BOLT-N-CLIP KIT

Why bolts are better than rivets:

- Bolts will not turn in Knife Back and are reusable.
- They will last thru the life of several sections.
- Bolts may be replaced easily if accidentally damaged or broken.
- No special tools are needed to change sections, only a 7/16 wrench or socket.
- Bolts and nuts hold better than rivets. They have a greater clamp load than rivets.

Fits most mowers, mower conditioners and combines. For 10' bar. Includes 9 Low Arch Clips, 1 High Arch Clip, Bolts & Nuts to do a 10' Bar

Order No	List
B55-0629	52.17



WHY TRY TIGER SHARK™ SECTIONS?

1. Serrated teeth allow more cutting surface.
2. They last longer, cut faster.
3. Cuts equally well in soybeans, alfalfa, grass hay, wheat, etc.



Customer Testimonial:

"I cut over 1000 acres of soybeans with the same **Herschel Tiger Shark™** sections. They stayed sharper longer and lasted longer than any section I have used."

- Roger Woodruff, Warren Co. Iowa

BALE COUNTER

Bale counter, reads up to 99,999. 4-hole mounting plate, push button reset, adjustable side arm. Fits most balers.



Order No. List
T55-0002 30.62



HAMMER RIVET TOOL
For Drive Rivets

Order No. List
T55-0812 30.71

UNIVERSAL END SECTIONS

HERSCHEL "End Sections" are made of one-piece high carbon, heat-treated steel for rugged use. They are punched with an oblong hole to virtually fit any standard cutterbar mower in use today. To install our "End Section", simply take off the last section on the shoe end of your sickle assembly and replace it with an "End Section". The change-over takes only a couple of minutes to complete and you will notice a big difference in time saved from unclogging your mower. We recommend using a R36-0523D oval head rivets or B55-0065D Bolts.

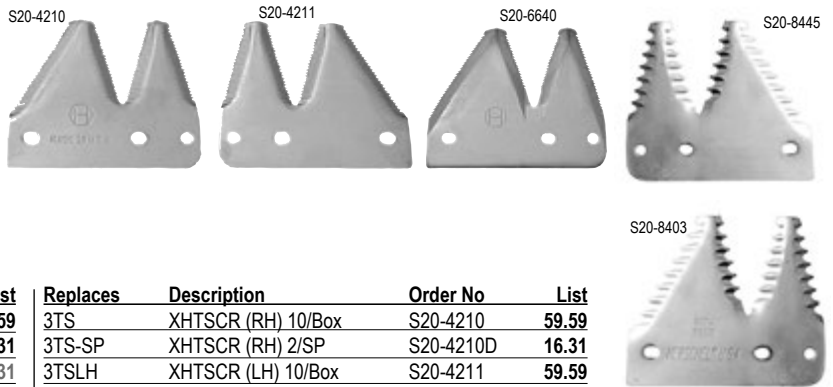

Replaces	Description	Order No	List
3TS-7	XH7TSCR (RH) 10/Box	S20-4403	59.59
3TS-7-SP	XH7TSCR (RH) 2/SP	S20-4403D	16.31
3TS-7	Tiger Shark™ (RH) 10/Box	S20-8403	64.31
3TS-7-SP	Tiger Shark™ (RH) 2/SP	S20-8403D	11.44
3TS-7-LH	XH7TSCR (LH) 10/Box	S20-4445	63.81
3TS-7-LH-SP	XH7TSCR (LH) 2/SP	S20-4445D	11.26
3TS-7-LH	Tiger Shark™ (LH) 10/Box	S20-8445	64.31
3TS-7-LH-SP	Tiger Shark™ (LH) 2/SP	S20-8445D	18.67

Replaces	Description	Order No	List
3TS	XHTSCR (RH) 10/Box	S20-4210	59.59
3TS-SP	XHTSCR (RH) 2/SP	S20-4210D	16.31
3TSLH	XHTSCR (LH) 10/Box	S20-4211	59.59
3TSLH-SP	XHTSCR (LH) 2/SP	S20-4211D	16.31
2US	XHUSCR (RH) 10/Box	S20-6640	63.12
2US	XHUSCR (RH) 2/SP	S20-6640D	16.31

STRAW CHOPPER SECTION - SUPER 7®

For Most Barn Straw Choppers. Section is 2-1/16" center to center. 1/4" holes. Plated. 25/box

Order No. List
S20-4332P 45.55

STRAW CHOPPER SECTION - XHUS

For Most Barn Straw Choppers. Section is 2-1/16" center to center. 1/4" holes. 10/box

Order No. List
S20-5169 19.53

TUB GRINDER SECTION

For Rotomix Grinders. Hardfaced. Section is 2-1/16" center to center. 5/16" holes. 10/box.

Order No. List
S20-1275 80.61

WEAR PLATES



For Mowers, Swathers, Combines. Replaces W50. 5-7/8" long. Slotted holes with 3" spacing.

Order No. List
P44-0591 3.33
P44-0591D* 12.02

*Display Pack of 2.



24" length with 1-1/2" spacing. Heat treated.

Order No. List
P44-0200 17.71

UNIVERSAL BOLTED SICKLES - HEADLESS

S35-1038/1039/1040



Fits IH Mowers & 990, 1190 M/C; Ford 505, 535, 536, 537 Mowers & 538 M/C; Gehl 880, 1090, 2130, 2160 M/C; Hesston all single drive M/C and Windrowers; New Holland 450, 451, 455, 456 Mowers & 460, 461, 467, 469, 1469, 472, 477, 478, 479, 488, 489, 490, 492, 1469 M/C; New Idea 10, 20, 30, 40, 41, 521, 522 Mowers & 290 M/C; Owatonna 180, 196, 197, 200, 206, 207, 208, 216, 217, 2140, 2170 M/C.

5, 8, 9, 11, 37, 38, 39, 47, 50, 250, 350, 450, 3700 Mowers, 480, 483, 485, 1207, 1209, 1217, 1219 M/C; Ford 50, 51, 62, 63, 64, 65, 66, 175, 176, 234, 257, 258, 259, 260, 501, 502, 515, 14-3, 14-4, 14-15, 14-16, 14-94, 95, 96, 97, 14-280, 1, 2, 3

Size	Hole Spacing	Section Type	No. Of Sections	Order No	List
7'	2-1/16"	XH7TS	30	S35-1038	124.53
9'	2-1/16"	XH7TS	38	S35-1039	146.18
9'	2-1/16"	TIGER SHARK™	38	S35-2639	167.97
2'	2-1/16"	XH7TS	9	S35-1040	59.95

Size	Hole Spacing	Section Type	No. Of Sections	Order No	List
9'	2"	XHUS	38	S35-1036	191.87
7'	2"	XHUS	30	S35-1064	124.52
2'	2"	XHUS	9	S35-1065**	59.95

Use C83-0750 Splice Kit **2' Extension comes with splice kit

Use C83-0755 Splice Kit

HOLD DOWN CLIPS NON-ADJUSTABLE

No matter what type of cutting condition you might encounter, we have a universal knife clip for you. The clips listed below are designed to adapt to virtually any standard cutter bar on mowers, swathers, windrowers, and even combines.



Fits Bolted sickles with head clearance. Steel.

Style	Order No.	List
Low Arch	C45-0692	5.55
Low Arch	C45-0692D*	14.16
High Arch	C45-0693	7.45
High Arch	C45-0693D*	11.29

*Pack of 2

HOLD DOWN CLIPS ADJUSTABLE



Fits Most Hay Machines and Combines. Cast.

Style	Order No.	List
Low Arch	C45-0006	37.80
High Arch	C45-0007	37.80



Fits most Combines, Mowers & Windrowers, except Versatile, Hart-Carter & Love. Steel.

Style	Order No.	List
Low Arch	C45-0040	9.05
Low Arch	C45-0040X*	271.89

*Box of 24 clips.

BALE SPEARS

Assembling Advice For Square Tines



RIGHT WRONG

- High Tensile Strength Heat Treated Steel
- Standard Duty 2500# 1-3/4" Diameter
- Heavy Duty 3500# 1-3/4" Diameter
- Threaded Spears Include Nut

BOLT ON SPEARS

Nut Included. Order Sleeve Separately.

Description	Length	Capacity	Order No	List
Threaded 36mm diameter	32"	1800 lbs	BS32ONEWN	53.25
Threaded 45mm diameter	32"	2500 lbs	BS32WN	76.13
Threaded 36mm diameter	39"	1800 lbs	BS39ONEWN	85.36
Threaded 45mm diameter	39"	2500 lbs	BS39WN	81.54
Threaded 45mm diameter	43"	2500 lbs	BS43WN	90.07
Threaded 45mm diameter	49"	2500 lbs	BS49WN	107.94
Threaded 45mm diameter	32"	3500 lbs	BS32WNHD	88.64
Threaded 45mm diameter	43"	3500 lbs	BS43WNHD	107.06
Threaded Heavy Duty	49"	3500 lbs	BS49WNHD	122.15

PIN ON SPEARS

Order Bushing/Sleeve Separately.

Description	Length	Capacity	Order No	List
Cross Bolt Standard Duty	43"	2500 lbs	BS43CB	90.48
Cross Bolt Standard Duty	49"	2500 lbs	BS49CB	109.13

HARDWARE

Description	Order No	List
Nut. 1.18" diameter	BSNUT	4.42
Sleeve Standard Duty. 4.72" long	BSSLEEVE	17.98
Sleeve Heavy Duty. 5.71" long	BSSLEEVEHD	21.30
Sleeve For Pin On w/1/2" hole. 5.71" long	BSSLEEVECB	20.24
Sleeve For 36mm diameter spears. 4.33" long	BSONESLEEVE	17.22

**1-YEAR
WARRANTY
ON ALL ITEMS!**

TEDDER TIRES

Ribbed tire and rim assembly. Includes bearings.

6 Ply. 1" Bore. 3.18" Hub Length

Fits Krone, Kuhn, John Deere, New Holland, M&W, Sitrex

Size	Order No.	List
15" x 600-6"	W29-1506	120.13
16" x 6.50-8"	W29-1608	152.49



W29-1608

4 Ply. 1" Bore. 2.28" Hub Length

Fits Galfre, Kuhn, John Deere, New Holland, Rossi, Sitrex, Tonutti, Vermeer

Size	Order No.	List
3.50" x 6"	W29-0306	101.54

RAKE WHEELS

Heavy Duty, .275. Fits Sitrex, Case, H&S, M&W, New Holland, Westward, AGCO, Atlas, Befco, Bush Hog, Hesston, Kelderman, MF, New Idea, Ogden, Otma, Panorama, Rhino and Ross.
Painted Creme
Overall diameter: 55"

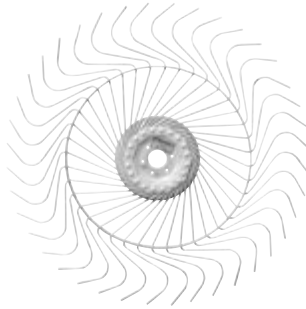

Description	Order No.	List
Right Hand	W16-0801	180.08
Left Hand	W16-0802	180.08

Replacement Tine Part Number T16-0815.

Heavy Duty, .276" (7mm). Fits Tonutti/National/Walton, John Deere/Frontier, Vermeer, Kuhn, Miller Pro/Arts Way, Gehl, Pequea.
Painted Black
Overall diameter: 55"

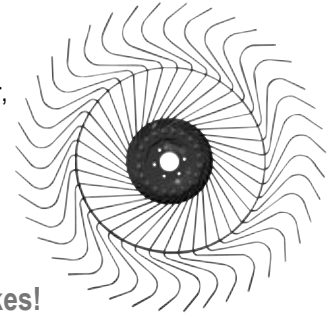

Fits Kuhn Speed Rakes!

Description	Order No.	List
Right Hand. P20BG003	W16-0805	180.08
Left Hand. P20BG004	W16-0806	180.08

Replacement Tine: T16-0497.

Heavy Duty, .275. Fits Sitrex, Case, H&S, M&W, New Holland, Westward & Others.
Painted Black
Overall diameter: 55"

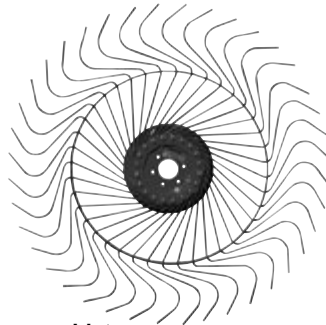

Description	Order No.	List
Right Hand	W16-0809	180.08
Left Hand	W16-0810	180.08

Replacement Tine Part Number T16-0815.

Heavy Duty, .276" (7mm). Fits Tonutti/National/Walton, John Deere/Frontier, Vermeer, Kuhn, Miller Pro/Arts Way, Gehl.
Painted Creme
Overall diameter: 55"

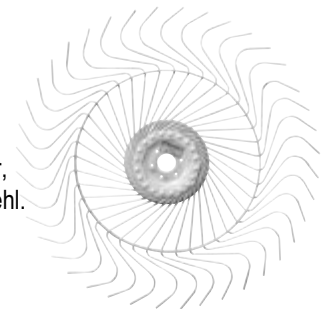

Description	Order No.	List
Right Hand. P20BG003	W16-0811	180.08
Left Hand. P20BG004	W16-0812	180.08

Replacement Tine: T16-0497.

HIGH CAPACITY RAKE WHEEL

.295". Fits Sitrex, H&S, New Holland & Others.
Painted Black
Overall diameter: 60". Black.

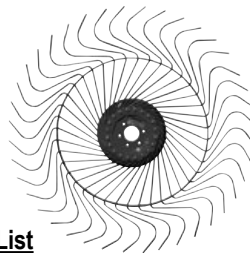

Description	Order No.	List
Right Hand	W16-0808	202.04
Left Hand	W16-0807	202.04

Replacement Tine Part Number T16-0495.

HUB ASSEMBLY

With bearing for all wheels listed at left. Pilot: 3.21". Bolt circle: 5.12". 13mm bolt required



Order No.	List
H16-1000	76.86

TINE BOLT AND NUT

Fits Sitrex, Case, H&S, M&W, New Holland, Westward & All Others. 10 Per Blister Pack



Order No.	List
B55-0800D	13.85

HERSCHEL POLY INSERTS

- Easy Installation - Pre-Drilled Holes
- Attaches To Rake Wheel With Heavy Duty Ties (Included)
- Increase Efficiency
- Prevents Wrapping
- Block Wind
- Inexpensive Add-On To Your Hay Rake



Application	OD	Center Hole	Order No	List
Sitrex, AGCO, CIH, H&S, Hesston, Kelderman, MF, M&W, NH, New Idea, Ogden & Rhino	55"	31-3/8"	W16-55S	61.51
Tonutti, Gehl, Bush Hog, John Deere, Kuhn, Vermeer & Vicon	55	34-1/2"	W16-55T	43.92
Sitrex	60"	31-3/8"	W16-60S	69.19



RAKE WHEEL SPRING

Fits H&S and other Wheel Rakes using lift springs on wheels. 1 used per hay turning wheel. 11" long. 1-7/8" OD. 1-1/2" ID .238 Diameter wire

Order No.	List
S16-1000	22.57

HA200A (G81-0231)

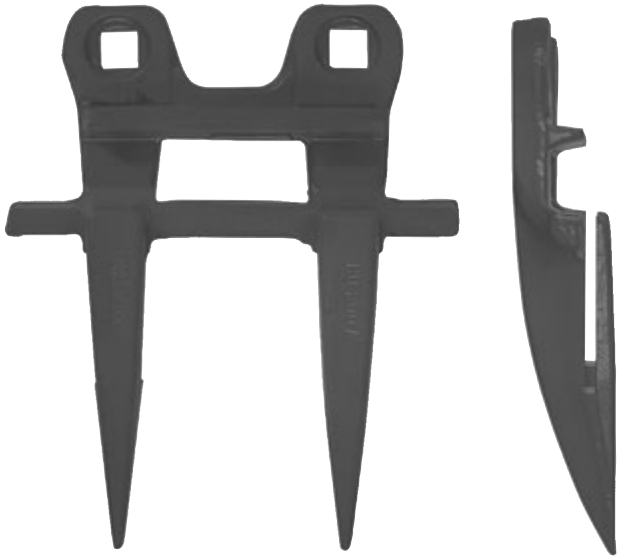

OEM	OEM PN#	Buchanan PN	Order No.	List
Case IH	700707147	BU200A	G81-0231	20.82
Hesston	700716292	BU200A		

Fits **Case-IH** Mower Conditioners – 8320, 8330, 8340, 8350, 8360, 8370, 8380, SC412, SC414, SC416. Windrowers – 8210, 8220, 8230, 8240, 8830, 8840. **Hesston** Mower Conditioners – 1110, 1120, 1130, 1150, 1160, 1170,

Weight: 1.69 lb (766.57 g)

HA206 (G81-0140)



OEM	OEM PN#	Buchanan PN	Order No.	List
Ford	110-32342	BU-206	G81-0140	26.09
Gehl	110-32342	BU-206		
	110-10327	BU-206		
Owatonna	110-32327	BU-206		

Fits **Ford** Windrower – Series - 537. **Ford-NH** Mower Conditioners – Series - 536. **Gehl** Mower Conditioners – 2140, 2170, 2175, 2240, 2245, 2270, 2275; Windrowers – Series – All After 1979. **Owatonna** Mower Conditioners – Series – All After 1979.

Weight: 1.77 lb (802.86 g)

HA209 (G81-0200)



OEM	OEM PN#	Buchanan PN	Order No.	List
CAT/Lexion	767265-1	N/A	G81-0200	23.47

Fits **Lexion** Combines - All

Weight: 1.72 lb (780.18 g)

HA210 (G81-0183)



OEM	OEM PN#	Buchanan PN	Order No.	List
Case IH	483500R3	BU-210	G81-0183	14.73
Ford	BU210	BU-210		
IH		BU-210		
New Idea	H483500R3	FS 85-2		
Rowse	670600			

Fits **Case IH** Mowers – Series – 200, 230, 1000, 1100, 1200, 1300, 3110; Forage Harvesters – Series – 650, 655; Mower Conditioners – Series – 170, 175, 200, 225, 816, 990. **Ford** Mower Conditioner – 538. **International Harvester** Combines – 820, 1010, 1020. **New Idea** Mowers – 521, 522. **Rowse** mowers using IH guards.

Weight: 1.78 lb (807.39 g)

HA215DM (G81-0097)



OEM	OEM PN#	Buchanan PN	Order No.	List
Case-IH	87560324, 87421451	NA	G81-0097	17.43
MacDon	23064, 28013, 118344, 118484	NA		

Fits **Case-IH** 1042, 1052, 2042, 2052, 2062, 2142, 2152, 2162. **MacDon** 960, 962, 963, 972, 973, 974, D50, D60, FD70, FD75. **New Holland** 84C, 86C. Double heat treat.

Weight: 1.70 lb (771.11 g)

DRIVE HEAD GUARD For models above: G81-0094 **19.14**
LEFT END GUARD For models above: G81-0092 **18.20**
RIGHT END GUARD For models above: G81-0096 **18.20**

HA215DHC (G81-0093)



OEM	OEM PN#	Buchanan PN	Order No.	List
Badger Northland	683994M1	BU-215A	G81-0093	25.55
Case IH	700707147	BU-215A		
	88615982	BU-215A		
Hesston	700707147	BU-215A		
	700716292	BU-215A		
Massey Ferguson	683476M1	BU-215A		
	683994M1	BU-215A		
New Holland	219191	BU-215A		
	858778	BU-215A		
	86521587	BU-215A		
	86553340	BU-215A		
	86615892	BU-215A		

Fits **Badger Northland** Mower Conditioners – All 1978. **Case IH** Mower Conditioners – 8230, 8330, 8340, 8350, 8360, 8370, 8380, SC412, SC414, SC416. Windrowers – 8210, 8220, 8230, 8820, 8830, SCX100. Auger – 8840. Draper Header – 1042. **Hesston** Mower Conditioners – 1110, 1120, 1130, 1150, 1170, 1260, 1270, 1275. Headers – 8010, 8020, 8100, 8200, 8400. 2010, 2020 Headers prior to S/N CBJ02000. **Massey Ferguson** Mower Conditioners – Series - 665, 675, 775. **New Holland** Headers – 971, 973, 71C, 73C, 74C. Windrowers – All Mower Conditioners and Windrowers

Weight: 1.70 lb (771.11 g)

HA215 (G81-0155) & HA215DH (G81-0098)



OEM	OEM PN#	Buchanan PN	Order No.	List
Badger Northland	683994M1	BU-215A	G81-0155	15.00
Case IH	700707147	BU-215A	G81-0098*	17.43
	88615982	BU-215A		
Hesston	700707147	BU-215A		
	700716292	BU-215A		
Massey Ferguson	683476M1	BU-215A		
	683994M1	BU-215A		
New Holland	219191	BU-215A		
	858778	BU-215A		
	86521587	BU-215A		
	86553340	BU-215A		
	86615892	BU-215A		

Fits **Badger Northland** Mower Conditioners – All 1978. **Case IH** Mower Conditioners – 8230, 8330, 8340, 8350, 8360, 8370, 8380, SC412, SC414, SC416. Windrowers – 8210, 8220, 8230, 8820, 8830, HDX121, HDX122, HDX141, HDX142, HDX161, HDX162, HDX181, HDX182, SCX100, SMX9. Auger – 8840. Draper Header – 1042. **Hesston** Mower Conditioners – 1110, 1120, 1130, 1150, 1170, 1260, 1270, 1275. Headers – 8010, 8020, 8100, 8200, 8400. 2010, 2020 Headers prior to S/N CBJ02000. **Massey Ferguson** Mower Conditioners – Series - 665, 675, 775. **New Holland** Headers – 971, 973, 71C, 73C, 74C. Windrowers – All Mower Conditioners and Windrowers

*Double Heat Treated. Can be used in place of G81-0155.

Weight: 1.70 lb (771.11 g)

HA218 (G81-0184)



OEM	OEM PN#	Buchanan PN	Order No.	List
New Holland	219190	BU-218	G81-0184	15.81

Fits **New Holland** Mowers – All

Weight: 1.70 lb (771.11 g)

HA218DH (G81-0144)



OEM	OEM PN#	Buchanan PN	Order No.	List
New Holland	219190	BU-218H	G81-0144	17.43

Fits **New Holland** Mowers – All

Double Heat Treated

Weight: 1.72 lb (780.18 g)

HA220 (G81-0185)



OEM	OEM PN#	Buchanan PN	Order No.	List
Gehl	072057	BU-220	G81-0185	19.25
John Deere	E48093	BU-220		
	E52667	BU-220		
	E82559	BU-220		

Fits **Gehl** Mower Conditioners – 770, 880, 1070, 1090. **John Deere** Mowers – 37, 38, 39, 250, 350, 450. Mower Conditioners – 480, 483, 485. Windrowers – 215, 215A, 780, 800, 880. Platform Augers – 18, 19, 183, 188, 220 & 230 prior to s/n 425000. Draper Platforms – 78, 88, 120, 130, 135

Weight: 1.61 lb (730.28 g)

HA221 (G81-0186)



OEM	OEM PN#	Buchanan PN	Order No.	List
John Deere	E52667	BU-221	G81-0186	20.75
John Deere	E62000	BU-221		

Fits **John Deere** Mower Conditioners – 1207, 1209, 1214; 1217, 1219 prior to s/n 710000; 1380, 1424. Platform Augers – 230 s/n 425001 and up; 240

Weight: 1.79 lb (811.93 g)

HA222DH (G81-0147)



OEM	OEM PN#	Buchanan PN	Order No.	List
John Deere	E72428	BU-222H	G81-0147	16.39

Fits **John Deere** Mower Conditioners and Windrowers with Platforms – 300, 300A prior to s/n 943000; Mower Conditioners – 1217, 1218 s/n 71001 & later; 1600.

Weight: 1.79 lb (811.93 g)

HA225 (G81-0187)



OEM	OEM PN#	Buchanan PN	Order No.	List
Allis-Chalmers	1116504	BC-225	G81-0187	19.25
Deutz-Allis	1116504	FC-225		
Gleaner	1116504	BC-225		

Fits All **Allis-Chalmers** GLEANER Combines – 1955 and later. All **Deutz-Allis** GLEANER Combines. GLEANER Headers

Weight: 1.06 lb (480.81 g)

HA231 (G81-0125)



OEM	OEM PN#	Buchanan PN	Order No.	List
Allis-Chalmers	1176532	BU-231	G81-0125	22.87
Hart-Carter	232155	BU-231		
	234006	BU-231		
	234239	BU-231		
	273846	BU-231		
International Harvester	179755C1	BU-231		
Deutz-Allis	1320143	BU-231		
Massey Ferguson	71320143	BU-231		
	1053174M1	BU-231		
White Farm	31-2749417	BU-231		

Fits **Allis-Chalmers** Combines – All Floating Head. **Deutz-Allis** GLEANER Combines – All Floating Head. **Hart-Carter** – All Floating Cutterbars. **International Harvester** – Combines – 810 Flex Head. **Massey Ferguson** Combines – Floating Platforms (except 9110 Flex). **White Farm** – Combines – All Floating Head.

Weight: 1.43 lb (648.64 g)

HA235 (G81-0070)



OEM	OEM PN#	Buchanan PN	Order No.	List
Cockshutt	895744L	BU-235	G81-0070	19.03
International Harvester	K8420S	BU-235		
Kilberry	K8420S	BU-235		
MacDon	K16716-1	BU-235		
	K8420S	BU-235		
Massey Ferguson	1041468M1	BU-235		
Oliver-White Farm	895744L	BU-235		

Fits **Cockshutt** Windrowers – All. **International Harvester** Windrower – 75. **Kilberry** Windrower. **MacDon** Windrowers – 1000 Series. **Massey Ferguson** Windrowers – 35, 665, 675, 775, 785. **Oliver White Farm** Windrowers – 501, 503.

Weight: 1.64 lb (743.89 g)

HA240 (G81-0191)



OEM	OEM PN#	Buchanan PN	Order No.	List
John Deere	H61954	BC-240-A	G81-0191	13.40
	H75386	BC-240-A		
	H145791	BC-240-A		
Massey Ferguson	228392M1	BC-240-A		
	228392M2	BC-240-A		
New Holland	134024	BC-240-A		
New Idea	714611	BC-240-A		
White	9510220	BC-240-A		

Fits John Deere Combine – 2-Prong, All Models. **Massey Ferguson** Combines – 2-Prong, All Models. **New Holland** Combines – Rigid Bar. **New Idea** Combines – Uni-Harvest, 71, 711, 715. **White**. Weight: 1.14 lb (517.01 g)

HA240S (G81-0021)



OEM	OEM PN#	Buchanan PN	Order No.	List
John Deere	H145791	BC-240-S	G81-0021	19.31

Fits **John Deere** Combines – All John Deere Platforms. **Massey Ferguson** Combines – All Rigid Bar Platforms. **New Holland** Combines – All New Holland Rigid Bar Platforms. **New Idea** Combines – 711, 713, 715. **White Farm** Combines – Fixed Cutter Bars

Weight: 1.14 lb (517.01 g)

HA245 (G81-0192)



OEM	OEM PN#	Buchanan PN	Order No.	List
Case IH	700700845	BU-245	G81-0192	13.29
Gehl	611179	BU-245		
	611902	BU-245		
Hesston	49239	BU-245		
	700700845	BU-245		
	748178	BU-245		
New Holland	65327	BU-245		
New Idea	BU245	BU-245		
Versatile	V94711	BU-245		
	65327	BU-245		

Fits **Case IH** Mower Conditioners – 8320, 8330, 8340, 8350, 8360, 8370, 8830. Windrowers – 8210, 8220, 8230, 8240, 8820, 8830. Auger Header – 8840. **Field Queen.** **Gehl** Mower Conditioners – 2130, 2160. Windrowers – 2230, 2262. **Hesston** Mower Conditioners – 1010, 1071, 1085, 1090, 1091, 1110, 1120, 1150, 1160. Windrowers – 310, 420, 500, 600, 620, 6200, 6400, 6610, PT10, PT12, PT7, 1014+2. Headers – 6450, 6465, 6566, 6665, 8050, 8100, 8200, 8400. **New Holland** – 970, 972. **New Idea** Combines – 815 through 820. **Versatile** – 4812, 4814

Weight: 1.72 lb (780.18 g)

HA245DH (G81-0042)



OEM	OEM PN#	Buchanan PN	Order No.	List
Hesston	700700845	BU-245H	G81-0042	18.96
	700707147	BU-245H		
	700716292	BU-245H		

Fits **Hesston** Mower Conditioner – All Models

Weight: 1.72 lb (780.18 g)

HA246 (G81-0246)



OEM	OEM PN#	Buchanan PN	Order No.	List
Hesston	66603		G81-0246	12.63

Fits **Hesston** Mower Conditioner – All Models

Weight: 1.71 lb (775.64 g)

HA250 (G81-0120)



OEM	OEM PN#	Buchanan PN	Order No.	List
Badger Northland	699020M1	BU-250	G81-0120	13.40
Gehl	049312	BU-250		
	060494	BU-250		
Hesston	049320	BU-250		
International Harvester	472717R1	BU-250		
J.I. Case	049312	BU-250		
John Deere	E71880	BU-250		
Massey Ferguson	669020M1	BU-250		
New Holland	257635	BU-250		
	86617061	BU-250		

Fits **Badger Northland** Mowers – 1978 and Later. **Gehl** Mower Conditioners. **Hesston** Mower Conditioners. **J.I. Case** Windrowers. **John Deere** Mowers. **International Harvester** Forage Harvesters. **Massey Ferguson** Windrowers. **New Holland** Mower Conditioners

CLIPS - Used With Above Guard		
DESCRIPTION	ORDER NO.	LIST
Low-Arch Clip	C45-0502	9.33
Hi-Arch Clip	C45-0503	14.18

All Stub Guard Applications

Weight: 1.15 lb (521.63 g)

HA260 (G81-0085)



OEM	OEM PN#	Buchanan PN	Order No.	List
Field Queen	049270	BT-260	G81-0085	19.61
Gehl	049270	BT-260		
Hesston	049270	BT-260		
International Harvester	823025C1	BT-260		
J.I. Case	049270	BT-260		
New Holland		BT-260		

CLIPS - Used With This Guard		
DESCRIPTION	ORDER NO.	LIST
Low-Arch Clip	C45-0500	9.11
Hi-Arch Clip	C45-0501	19.03

Fits **Field Queen** Windrowers – 420, 620. **Gehl** Windrowers. **Hesston** Mower Conditioners – All Models, Tie Guards. **International Harvester** Windrowers – All, except – 75. **J.I. Case** Windrowers – Same as FQ245 using Tie Guards. **New Holland** Windrowers.

Weight: 1.39 lb (630.49 g)

HA265 (G81-0055)



OEM	OEM PN#	Buchanan PN	Order No.	List
Case IH	633098R1	BC-265	G81-0055	25.18

Fits **Case IH** Combine – 810, 815, 915 Headers

Weight: 1.38 lb (625.96 g)

HA270 (G81-0035)



OEM	OEM PN#	Buchanan PN	Order No.	List
Case IH	613838R2	BU-270	G81-0035	17.77
Field Queen	788278	BU-270		
Gehl	044779	BU-270		
International Harvester	613838R2	BU-270		
Kosch	K101	BU-270		
New Idea	H613838R2	BU-270		

Fits **Case IH** Mowers – 100, 110, 115, 120. Mower Conditioners – 1190, 1290, 1490, 1590. Windrowers – 75, 210, 230, 275, 375, 4000, 5000, 5500. Platforms – All 820 Platforms – Fit 110 and 1020 Platforms with Guards equipped with Cross Bar. **Field Queen** Hay Harvesters – All. **Gehl** Mower Conditioners – MA206A, HK108, HK440. **International Harvester** Windrowers – 175, 200. Mowers – All. **Kosch** Mowers – All

Weight: 2.02 lb (916.26 g)

HA275 (G81-0196)



OEM	OEM PN#	Buchanan PN	Order No.	List
J.E. Love	LB208	BU-275	G81-0196	13.40
	LB214	BU-275		
New Holland	273846	BU-275		
	271971	BU-275		

Fits **J.E. Love** Combines – All floating heads. **New Holland** Combines – All floating heads.

Weight: 1.30 lb (589.69 g)

HA290 (G81-0197)



OEM	OEM PN#	Buchanan PN	Order No.	List
Versatile	9705050	BU-290	G81-0197	15.81
	SW-1605	BU-290		

Fits **Versatile** Windrowers – 10V, 400V, 440V, 1400V, 1950V, 2400V, 4400V

Weight: 1.40 lb (635.03 g)

HA299 (G81-0037)



OEM	OEM PN#	Buchanan PN	Order No.	List
Case IH	1307299C1	BU-299	G81-0037	17.36

Fits **Case IH** Combine – 1020

Weight: 1.87 lb (848.22 g)

HA340 (G81-0026)



OEM	OEM PN#	Buchanan PN	Order No.	List
John Deere	H25603	BC-340	G81-0026	31.25
	H153855	BC-340		
Massey Ferguson	1053174M1	BC-340		

Fits **John Deere** combines – All 3-prong applications. **Massey Ferguson** Combines – All 3-prong applications

Weight: 1.50 lb (680.39 g)

HA504 (G81-0973)



OEM	OEM PN#	Buchanan PN	Order No.	List
Case-IH	118301	NA	G81-0973	19.25

Fits **Case-IH** 3020, 3152, 3162.

Main Guard

HA505 (G81-0974)



OEM	OEM PN#	Buchanan PN	Order No.	List
Case-IH	118302	NA	G81-0974	19.25

Fits **Case-IH** 3020, 3152, 3162.

Head Guard

HA542 (G81-0203)



OEM	OEM PN#	Buchanan PN	Order No.	List
John Deere	6262790		G81-0203	14.40

Fits **CAT, CLAAS, LEXION** F20, F25, F30, F525, F530, F535, F540 to s/n 44100862.

HA610 (G81-0398)



OEM	OEM PN#	Buchanan PN	Order No.	List
John Deere	H205448 H213398	BU610	G81-0398	20.86

Fits **John Deere** 600, 700 series flex heads.

HA610H (G81-0537)



OEM	OEM PN#	Buchanan PN	Order No.	List
John Deere	H229537		G81-0537	19.58

Fits **John Deere** 600, 700 series rigid and draper headers. 900 series draper heads. Double Heat Treated.

HA611 (G81-0540)



OEM	OEM PN#	Buchanan PN	Order No.	List
John Deere	AH226928		G81-0540	23.65

Fits **John Deere** 600D, 600F, 600FD, 600R, 700D, 700F, 900D. Center hold down, double drive (2 used).

HA612 (G81-0541)



OEM	OEM PN#	Buchanan PN	Order No.	List
John Deere	H228526		G81-0541	16.38

Fits **John Deere** 600D, 600FD, 700D, 700FD, 900D. Single point end guard.

HA613 (G81-0542)



OEM	OEM PN#	Buchanan PN	Order No.	List
John Deere	HXE19625		G81-0542	26.65

Fits **John Deere** 600FD, 700FD Double Drives (1 used).

HA614 (G81-0543)



OEM	OEM PN#	Buchanan PN	Order No.	List
John Deere	HXE18172	G81-0543		26.65

Fits **John Deere** 600FD, 700FDDouble Drive (1 used).

HA615 (G81-0399)



OEM	OEM PN#	Buchanan PN	Order No.	List
John Deere	H213507 AH205482 AH213055 H205447 H213400	BU615	G81-0399	20.86

Fits **John Deere** 600, 700 series flex heads.

HA615H (G81-0538)



OEM	OEM PN#	Buchanan PN	Order No.	List
John Deere	H229538	G81-0538		19.58

Fits **John Deere** 600, 700 series rigid and draper headers. 900 series draper heads. Double Heat Treated.

HA630 (G81-0397)



OEM	OEM PN#	Buchanan PN	Order No.	List
John Deere	H213408	BU630	G81-0397	20.89

Fits **John Deere** 600 series rigid and draper headers. 900 series draper heads.

HA635 (G81-0396)



OEM	OEM PN#	Buchanan PN	Order No.	List
John Deere	H213405	BU635	G81-0396	20.58

Fits **John Deere** 600 series rigid and draper headers. 900 series draper heads.

HA641 (G81-0092)



OEM	OEM PN#	Buchanan PN	Order No.	List
Case-IH	118301	NA	G81-0092	18.20
MacDon	118301	NA		

Fits **Case-IH** 1042, 1052, 2042, 2052, 2062, 2142, 2152, 2162. **MacDon** 972, D50, D60, D65, FD70, FD75. **New Holland** 84C, 86C.

Left hand overlap guard for double drive heads. 1 used per machine.

HA642 (G81-0096)



OEM	OEM PN#	Buchanan PN	Order No.	List
Case-IH	118302	NA	G81-0096	18.20
MacDon	118302	NA		

Fits **Case-IH** 1042, 1052, 2042, 2052, 2062, 2142, 2152, 2162. **MacDon** 972, D50, D60, D65, FD70, FD75. **New Holland** 84C, 86C.

Right hand overlap guard for double drive heads. 1 used per machine.

HA643 (G81-0094)



OEM	OEM PN#	Buchanan PN	Order No.	List
Case-IH	87422041	NA	G81-0094	19.14
MacDon	118345	NA		

Fits **Case-IH** 1042, 1052, 2042, 2052, 2062, 2142, 2152, 2162. **MacDon** 972, D50, D60, D65, FD70, FD75. **New Holland** 84C, 86C.

Guard for drive head areas. 2-6 used per machine.

GUARDS

MALLEABLE GUARDS

Fits 7/16" Bars. Fits all Mowers

Replaces	Description	Order No	List
DM700, T27293	Center Guard	G81-0803	8.24
FD800	Center Guard	G81-0807	10.09
MC2041Z	Center Guard	G81-0830	14.85



Fits MASSEY FERGUSON Dyna Balance Mowers.

Replaces	Description	Order No	List
679837M91	Center Guard	G81-0181	17.44



RIVET

For guard numbers G81-0803, G81-0805, G81-0807, G81-0778. 1-1/4" x 6 CS. 1/2 lb box.

Order No	List
R6-0468D	8.28

GUARD BOLT/NUT

#3 bolt. Replaces L1316, L1317. 7/16" x 1-1/2". Grade 5 hardened.

Qty	Order No	List
50	B55-0260	33.96
10	B55-0260D	11.47



GUARD BOLT/NUT

#3 bolt. Replaces LB318. 7/16" x 1-3/4". Grade 5 hardened.

Qty	Order No	List
50	B55-0265	28.02
10	B55-0265D	11.47



CONICAL GUARD BOLT NUT

Package includes 5 7/16" nuts.

Order No	List
N83-0593D	7.72

CARRIAGE BOLT/NUT

GR 5 Plated. 7/16" x 1-1/2". 50 nuts/bolts per package

Order No	List
B55-0150	33.96

CARRIAGE BOLT/NUT

GR 5 Plated. 7/16" x 1-3/4". 50 nuts/bolts per package. Used in clip area.

Order No	List
B55-0145	33.96

GUARD PLATE

Replaces Z5110H. For G81 0803. 10/box.

Order No.	List
P44-0646	19.36



GUARD PLATE

Replaces 142570. For G81-0807. 10/box

Order No.	List
P44-0603	15.44



RAKE WHEELS

Fits Kuhn
Speed Rakes!

Heavy Duty, .275. Fits Sitrex, Case, H&S, M&W, New Holland, Westward, AGCO, Atlas, Befco, Bush Hog, Hesston, Kelderman, MF, New Idea, Ogden, Otma, Panorama, Rhino and Ross.
Painted Creme
Overall diameter: 55"

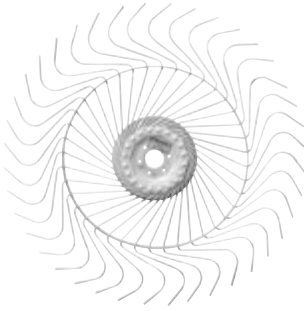

Heavy Duty, .276" (7mm). Fits Tonutti/National/Walton, John Deere/Frontier, Vermeer, Kuhn, Miller Pro/Arts Way, Gehl, Pequea.
Painted Black
Overall diameter: 55"
6 - 12.5 MM Mounting Holes
131 MM Bolt Circle
80 MM Center Hole

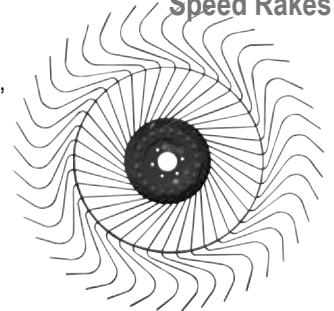

Description	Order No.	List
Right Hand	W16-0801	180.08
Left Hand	W16-0802	180.08

6 - 11 MM Mounting Holes
133 MM Bolt Circle
81 MM Center Hole
Replacement Tine Part Number T16-0815.

Description	Order No.	List
Right Hand. P20BG003	W16-0805	180.08
Left Hand. P20BG004	W16-0806	180.08

Replacement Tine: T16-0497.

Heavy Duty, .275. Fits Sitrex, Case, H&S, M&W, New Holland, Westward & Others.
Painted Black
Overall diameter: 55"

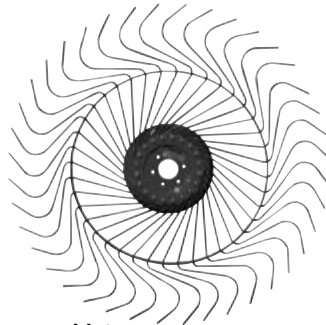

6 - 12.5 MM Mounting Holes
131 MM Bolt Circle
80 MM Center Hole

Heavy Duty, .276" (7mm). Fits Tonutti/National/Walton, John Deere/Frontier, Vermeer, Kuhn, Miller Pro/Arts Way, Gehl.
Painted Creme
Overall diameter: 55"

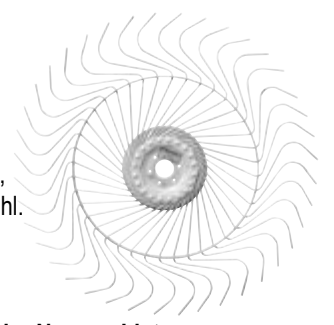

Description	Order No.	List
Right Hand	W16-0809	180.08
Left Hand	W16-0810	180.08

6 - 11 MM Mounting Holes
133 MM Bolt Circle
81 MM Center Hole
Replacement Tine Part Number T16-0815.

Description	Order No.	List
Right Hand. P20BG003	W16-0811	180.08
Left Hand. P20BG004	W16-0812	180.08

Replacement Tine: T16-0497.

HIGH CAPACITY RAKE WHEEL

.295". Fits Sitrex, H&S, New Holland & Others.
Painted Black
Overall diameter: 60". Black.

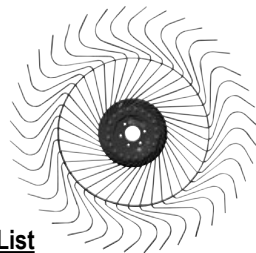

Fits New Holland Procart 819, 1022, 1225; Duravee 817, 1020, 1225*, 1428, 1631*, 1833, 2036, H5920, HT152, HT154, P1225P*, P1428P* and others using 55" Diameter wheels. *Confirm wheel diameter prior to ordering.

Color: New Holland Yellow
Diameter: 55"
Bolt Pattern: 5-1/4"
Pilot: 3-3/16"
Bolts: Accepts 10mm or 7/16"

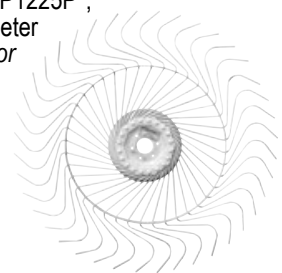

Description	Order No.	List
Right Hand	W16-0808	202.04
Left Hand	W16-0807	202.04

6 - 11 MM Mounting Holes
133 MM Bolt Circle
81 MM Center Hole
Replacement Tine Part Number T16-0495.

Description	Order No.	List
RH Rake Wheel	W16-0814	180.08
LH Rake Wheel	W16-0815	180.08

HUB ASSEMBLY

Fits 55" & 60" Sitrex rake wheels. With bearing for all wheels listed at left. Pilot: 3.21". Bolt circle: 5.12". 13mm bolt required



Order No.	List
H16-1000	76.86

TINE BOLT AND NUT

Fits Sitrex, Case, H&S, M&W, New Holland, Westward & All Others. 10 Per Blister Pack



Order No.	List
B55-0800D	13.85



RAKE WHEEL SPRING

Fits H&S and other Wheel Rakes using lift springs on wheels. 1 used per hay turning wheel. 11" long. 1-7/8" OD. 1-1/2" ID. .238 Diameter wire

Order No.	List
S16-1000	22.57

RAKE/TEDDER TEETH

HERSCHEL POLY INSERTS

- Easy Installation - Pre-Drilled Holes
- Increase Efficiency
- Block Wind
- Attaches To Rake Wheel With Heavy Duty Ties (Included)
- Prevents Wrapping
- Inexpensive Add-On To Your Hay Rake



Application	OD	Center Hole	Order No	List
Sitrex, AGCO, CIH, H&S, Hesston, Kelderman, MF, M&W, NH, New Idea, Ogden & Rhino	55"	31-3/8"	W16-55S	61.51
Tonutti, Gehl, Bush Hog, John Deere, Kuhn, Vermeer & Vicon	55	34-1/2"	W16-55T	43.92
Sitrex	60"	31-3/8"	W16-60S	69.19

TEDDER RAKE TEETH

Replaces Number	OEM	Application	US #	Wire Color	Wire Gauge	A Length	B Width	C Coil OD	Pkg. Qty.	Order No	List
1-043-030-10700	Fahr		FT-1	Black	.344"	12-3/4"		2-1/4"	25	FT-1	15.33
10370000	Galfre	New Models	GS-1	Red	.375"	15-1/4"	3-1/2"	2-11/16"	20	T16-0814	17.58
	Galfre Rakes	280, GTS280		Black		13-1/2"	3-1/2"	2.787"	25	GT46S	14.78
		ST280 1995 & Newer. Tedders with black tines.									
	Hesston	3710, 3717, 3727, 3740		Black		13-1/2"	3-1/2"	2.787"	25	GT46S	14.78
278687	New Holland	156,158,162	KT-2	Yellow	.375"	13.875"	3-5/8"	2-3/4"	25	T16-0801	13.49
585-619-00	Kuhn	GF440, GF4000M									
585-052-10	Kuhn		KT-1	Yellow	.375"	13"		2-3/4"	25	T16-0802	16.49
576-090-00	Kuhn	GF22N, GF5000, GF6001	KT-3	Yellow	.375"	14.125"	3-5/8"	2-3/4"	25	T16-0803	14.15
	New Idea	4210, 4217, 4227		Black		16"	3-1/2"	2.787"		GT46S	14.78
10521L	Niemeyer		NM-2	Yellow	.375"	13"		2-5/16"	25	T16-0813	15.76
200-401, 210-574	Sitrex, Tonutti				.375"	14"		2-3/4"	25	T-2	12.33

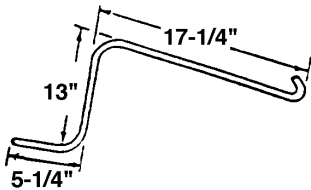
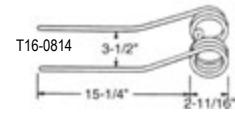
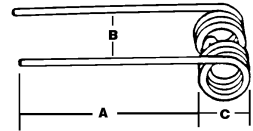

WHEEL RAKE TOOTH

Replaces PR015, T-1. Right hand. Cream color. Wire gauge is .244". Old Style.

OEM: Tonutti

Order No. T16-0808
List 2.32

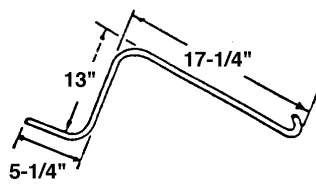

WHEEL RAKE TOOTH

Replaces PL015, T-1A. Left hand. Cream color. Wire gauge is .244". Old Style.

OEM: Tonutti

Order No. T16-0809
List 2.32

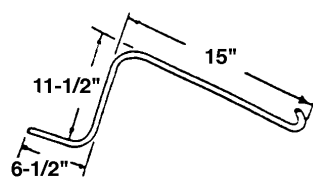

WHEEL RAKE TOOTH

For H&S, Sitrex, Atlas, Koehn & M&W. Replaces 203055, OT-1. Cream color. Wire gauge is .262".

OEM: OTMA

Order No. T16-0810
List 2.23

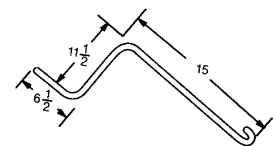

WHEEL RAKE TOOTH

For H&S, Sitrex, Atlas, Koehn & M&W. Replaces 203055, OT-1A. Cream color. Wire gauge is .281".

OEM: OTMA

Order No. T16-0815
List 2.32

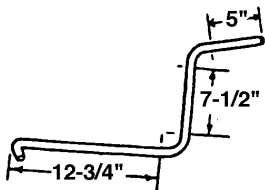

WHEEL RAKE TOOTH

For Rossi and Durabilt. Replaces 6087-54, R-1. Cream color. Wire gauge is .262".

OEM: Rossi

Order No. T16-0811
List 2.38

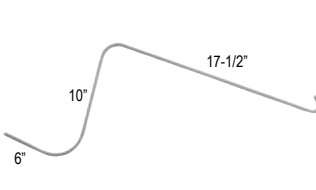

WHEEL RAKE TOOTH

Replaces 70176116, 36133. Short 10", 6 Wheel. Tonutti. Black color. Wire gauge is .262".

OEM: Vicon, Kuhn

Order No. T16-0489
List 2.23

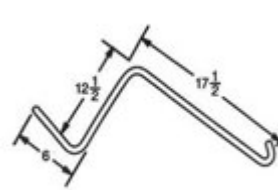

WHEEL RAKE TOOTH

Long 12-1/2", 5 Wheel. Replaces VI-2, 93611. Cream color. Wire gauge is .262".

OEM: Vicon

Order No. T16-0490
List 2.32

WHEEL RAKE TOOTH

For Sitrex and New Holland 60" rakes. .295" wire. 7" x 11-3/4" x 18". Black.

Order No. T16-0495
List 2.68

WHEEL RAKE TOOTH

For Kuhn Speed Rakes. Replaces 70176116. .278" wire.

Order No. T16-0497
List 2.49



**RUBBER MOUNT
LEFT HAND RAKE TOOTH**
For NEW HOLLAND Rakes
56B, 27, 259, 216, 256, 258,
260, 269 & 216. Replaces
65668L.

<u>Order No.</u>	<u>List</u>
T16-0154	4.97



**RUBBER MOUNT
RIGHT HAND RAKE TOOTH**
For NEW HOLLAND Rakes
56B, 27, 259, 216, 256, 258,
260, 269 & 216. Replaces
130941R.

<u>Order No.</u>	<u>List</u>
T16-0166	4.74



RUBBER MOUNT RAKE TOOTH
For HESSTON Rakes 3700, 3800, 3810, 3900,
3950. JOHN DEERE Twin Rake 700, 705. MF
Rakes 585, 588. VERMEER R9, R21, R23,
R23A, R24, R24A, R2300. Replaces EF2888001,
AE56204. Right/Left hand. 1-5/8" inside saddle
width, centered mounting holes. 100/box.

<u>Order No.</u>	<u>List</u>
T16-0185	5.07



RUBBER MOUNT RAKE TOOTH
For Round bar rakes. Universal. JOHN
DEERE Rakes 640, 650, 660, 670, 672,
662, 652, 896A. NEW HOLLAND 55, 56,
57, 2560. Replaces 1/4 x 3/4 LPK, RMT-1,
AE47389. Right hand. 1-11/16" inside saddle
width. Offset mounting holes. 100/box.

<u>Order No.</u>	<u>List</u>
T16-0182	3.15



**RUBBER MOUNT
RIGHT HAND RAKE TOOTH**
For Morrill, Farmahand, NI,
Darf Rola Rake and Others.
Replaces RMT2, 2117RH,
400341 and 491478. 10/box.

<u>Order No.</u>	<u>List</u>
T16-0190	9.52



**HEAVY DUTY RUBBER
MOUNT RAKE TOOTH**
For Darf, Rowse and New Idea.
Replaces RMT-2, 2117RLR,
WR5901, 400341 and 491478.
Heavy Duty.

<u>Order No.</u>	<u>List</u>
T16-0195	7.40

ALLIS CHALMERS

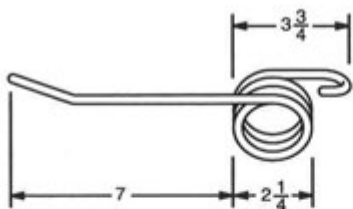

Order No. AC-1 3.39
 531727
 U.S. No. AC-1
 Rake .244 Wire, Red
 0.43 Lbs. 100/Case

CASE

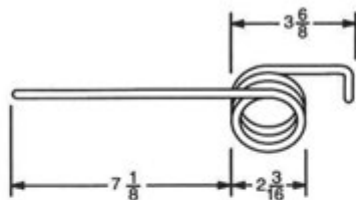

Order No. C-1 3.83
 T-17350
 U.S. No. C-1, Model 281
 Rake (1960 on)
 .244 Wire, Black
 0.42 Lbs. 100/Case

ALLIS CHALMERS

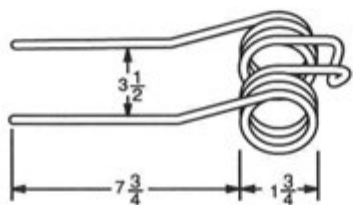

Order No. AC-2 6.43
 511506
 U.S. No. AC-2
 Rake .244 Wire, Black
 0.74 Lbs. 100/Case

CASE

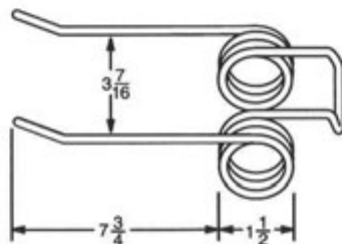

Order No. T16-0305 4.39
 R-740S
 U.S. No. C-2A
 Rake .225 Wire, Black
 0.5 Lbs. 100/Case

FAHR

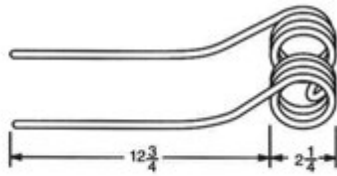

Order No. FT-1 15.33
 1-043-030-10700
 U.S. No. FT-1
 Tedder .344 Wire, Black
 2.0 Lbs. 25/Case

GALFRE

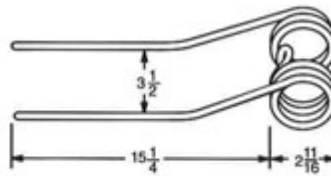

Order No. T16-0814 17.58
 10370000
 U.S. No. GS-1
 Tedder .375 Wire, Black
 2.8 Lbs. 20/Case

INTERNATIONAL HARVESTER

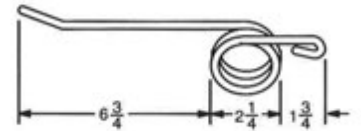

Order No. T16-0126 2.82
 457374R1 / 462978R1
 U.S. No. IH-1, IH-1A, IH-1B
 Models 3, 4, 5, 8, 9, 11, 14, 15,
 16, 30, 35, 86, 96, 97 Rakes
 .225 Wire, Red
 0.3 Lbs. 100/Case

FARMHAND

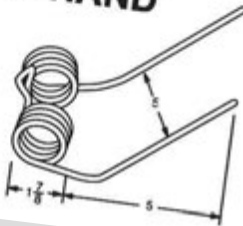

Order No. T16-0368 6.38
 L2117/RH (ID-4803R)
 U.S. FH-2
 Model F-76
 Rake
 .262 Wire, Black
 0.9 Lbs. 50/Case

FORD

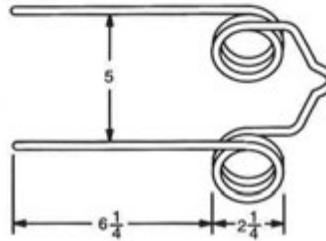

Order No. T16-0340 5.77
 146545
 U.S. No. F-2
 Model 503 Rake .244 Wire, Black
 0.8 Lbs. 50/Case

INTERNATIONAL HARVESTER

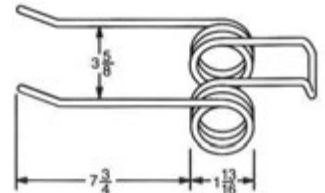

Order No. IH-22-2 6.34
 455165R1
 U.S. No. IH-22-2
 Model 5, 1952 & up
 Rake .244 Wire, Red
 0.9 Lbs. 50/Case

FORD

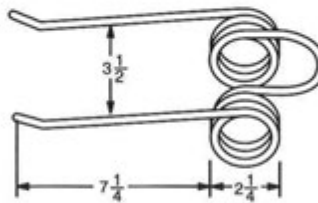

Order No. F-2B 6.87
 143049
 U.S. No. F-2B
 Rake .244 Wire, Black
 0.82 Lbs. 50/Case

RAKE/TEDDER TEETH

JOHN DEERE

Order No. T16-0330 2.78

257-SE
U.S. No. JD-1
Model 350, 851, 858, 894, 896
Rakes 24T, 216T Balers
.244 Wire, Green
0.4 Lbs. 100/Case

JOHN DEERE

Order No. T16-0320 4.85

186SE
U.S. No. JD-2G
Models 553, 594
Side Delivery Rake
.244 Wire, Black
0.7 Lbs. 100/Case

KUHN

Order No. T16-0802 16.49

585-052-10
U.S. No. KT-1
Tedder
.375 Wire, Yellow
2.5 Lbs. 25/Case

JOHN DEERE

Order No. T16-0315 6.40

E35277
U.S. No. JD-1A
Model 567 Wheel Rake
.262 Wire, Black
0.9 Lbs. 50/Case

KELLY RYAN

Order No. KR-2L* 4.85

RR14L
U.S. No. KR-2L
Rake .244 Wire, Black
0.7 Lbs. 100/Case

KUHN

Order No. T16-0801 13.49

585-619-00
U.S. No. KT-2
Tedder Model GF440,
GF4000M
.375 Wire, Yellow
2.5 Lbs. 25/Case

JOHN DEERE

Order No. T16-0325 4.45

194SE / 237SE
U.S. No. JD-2
Model 14, 596, 597, 714 Rakes
.225 Wire, Black
0.6 Lbs. 100/Case

KUHN

Order No. T16-0803 14.15

576-090-00
U.S. No. KT-3
Tedder Models GF22N,
GF5000, GF6001
.375 Wire, Yellow
2.5 Lbs. 25/Case

*Special Order Only. Minimum Order Required

MASSEY FERGUSON

Order No. T16-0335 **3.34**
 667530M0 / 668364M1
 DE03435A
 U.S. No. MF-1, MF-1C, MF-1D
 Models 25, 36, 37
 Rakes .262 Wire, Black
 0.4 Lbs. 100/Case

NEW HOLLAND

Order No. T16-0370 **2.64**
 64562 / 46993
 U.S. No. NH-1A
 Model 55, 56B & 57 Rakes
 256, 258, 259, 260
 Rotobar .262 Wire, Yellow
 0.5 Lbs. 100/Case

CLIP
 for T16-0370. 10 per bag.

Order No. List
 C45-0493B 10.82

MASSEY FERGUSON

Order No. T16-0367 **2.90**
 667656M1
 U.S. No. MF-1A
 All Rakes to 1958
 .244 Wire, Black
 0.3 Lbs. 100/Case

NEW IDEA

Order No. NI-1 **3.04**
 0782ME1
 U.S. No. NI-1
 Rakes 1957 on
 .244 Wire, Green
 0.4 Lbs. 100/Case

NEW HOLLAND

Order No. NH-1 **2.29**
 40917
 U.S. No. NH-1
 Model 55 Rake 1950
 .244 Wire, Yellow
 0.4 Lbs. 100/Case

NEW IDEA

Order No. T16-0380 **4.61**
 048ME & M8
 U.S. No. NI-2
 Model (4 Bar) 4, 44, 45G,
 1948 & up
 .244 Wire, Green
 0.7 Lbs. 100/Case

OLIVER

Order No. O-1 **3.39**
 500629E
 U.S. No. O-1
 Model 107 (5 Bar)
 Side Del. Rake, A1 Roto Bar
 .262 Wire, Black
 0.4 Lbs. 100/Case

OTMA

Order No. T16-0810D 18.92

203055
U.S. No. OT-1
Wheel Rake
.262 Wire, Cream
0.5 Lbs. 100/Case

Note: Also fits H&S, Sitrex and Atlas Wheel Rakes

POLLARD

Order No. T16-0390 3.09

1706
U.S. No. P-1A-1
Rake .262 Wire, Black
0.4 Lbs. 100/Case

TONUTTI

Order No. T16-0808D 19.45

PR015
U.S. No. T-1
Wheel Rake, Right Hand
.244 Wire, Cream
0.5 Lbs. 100/Case

POLLARD

Order No. T16-0395 3.39

7D265
U.S. No. P-1B
Rake
.262 Wire, Black
0.4 Lbs. 100/Case

TONUTTI

Order No. T16-0809D 17.25

PL015
U.S. No. T-1A
Wheel Rake Left Hand
.244 Wire, Cream
0.5 Lbs. 100/Case

CASE

Order No. T16-0030 4.67
 750075
 U.S. No. HE-2
 Made by Hesston
 .225 Wire, Red
 0.75 Lbs. 100/Case

INTERNATIONAL HARVESTER

Order No. T16-0128 4.58
 540565R1
 U.S. No. IH-2G
 Model 9901190
 .225 Wire, Red
 0.6 Lbs. 100/Case

NEW HOLLAND

Order No. T16-0032 4.96
 76517
 U.S. No. NH-2E
 Haybine Models 460, 461, 467,
 468, 472, 474, 488, 492, 903,
 907, 909, 912, 1100, 1112, 1114,
 Self Propelled model 1118
 .225 Wire, Yellow
 0.65 Lbs. 50/Case

JOHN DEERE

Order No. JD-2E 4.28
 E37596
 U.S. No. JD-2E
 Models 480, 483, 485,
 old models 1207, 1209, 1214
 .225 Wire, Yellow
 0.58 Lbs. 100/Case

HESSTON

Order No. T16-0030 4.67
 750075
 U.S. No. HE-2
 Models PT-7, PT-10, PT-12, 1012,
 1014, 1070, 1090, 420, 620, 6600
 .225 Wire, Red
 0.7 Lbs. 100/Case

JOHN DEERE

Order No. T16-0332 4.96
 E-10711
 U.S. No. JD-2E-1
 Models 1207, 1209, 1217, 1210,
 1380, 230 new models
 .244 Wire, Yellow
 0.7 Lbs. 100/Case

FREEMAN

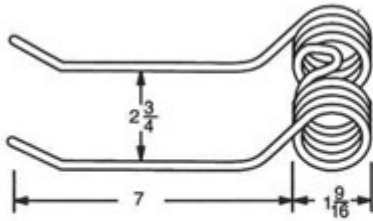

Order No. T16-0226 4.33

F1226
U.S. No. FR-1
Baler .187 Wire, Black
0.4 Lbs. 100/Case

HESSTON

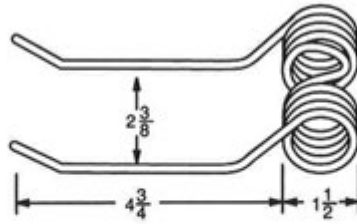

Order No. T16-0012 4.05

7894751
U.S. No. HE-3
Baler .187 Wire, Red
0.4 Lbs. 100/Case

HESSTON

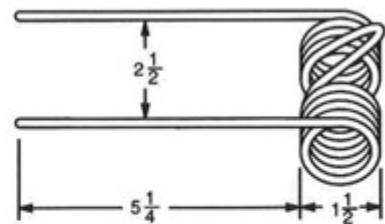

Order No. HE-6 4.83

2700222/1710102
U.S. No. HE-6
Baler .187 Wire, Red
0.4 Lbs. 100/Case

HESSTON

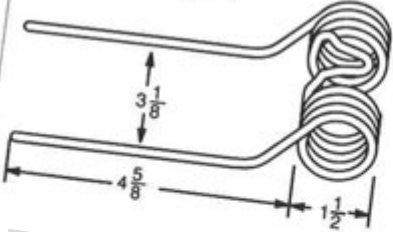

Order No. T16-0040 4.52

7751621
U.S. No. HE-1
Models 5600 & 5800 Balers
.187 Wire, Red
0.4 Lbs. 100/Case

HESSTON

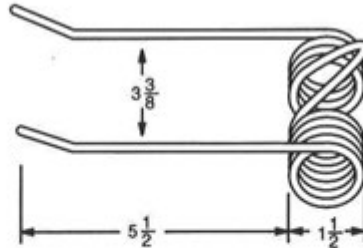

Order No. HE-5 5.54

7894306
U.S. No. HE-5
Baler .225 Wire, Red
0.6 Lbs. 100/Case

HESSTON

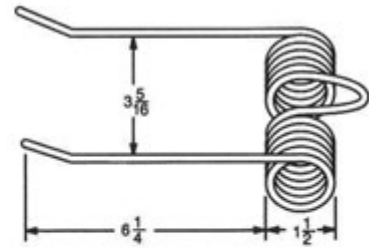

Order No. T16-0164 6.26

7893746
U.S. No. HE-7
4800 Baler .207 Wire, Red
0.7 Lbs. 100/Case

INTERNATIONAL HARVESTER

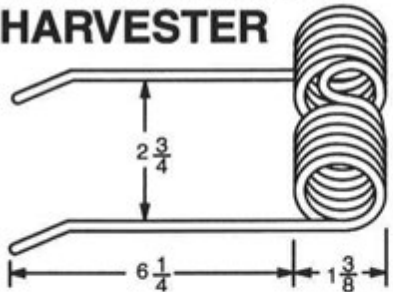

Order No. IH-2A 4.47

210614-C1
U.S. No. IH-2A
Baler .177 Wire, Black
0.5 Lbs. 100/Case

INTERNATIONAL HARVESTER

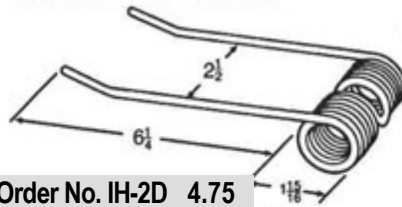

Order No. IH-2D 4.75

700709210 / 700714459
U.S. No. IH-2D
Models Case IH 8430, 8440, 8480
Hesston 514, 540, 740, 840
MF 1744
NI 4644, 6244, 6344
Balers .193 Wire, Black
.7 Lbs. 100/Case

HESSTON

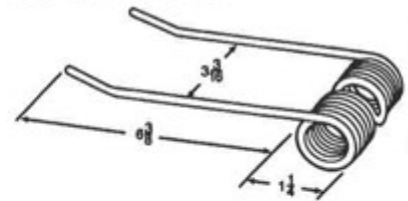

Order No. T16-0163 6.23

700706128
U.S. No. HE-8
Baler .207 Wire, Red
Models 4460 & 4650
0.7 Lbs. 100/Case

INTERNATIONAL HARVESTER

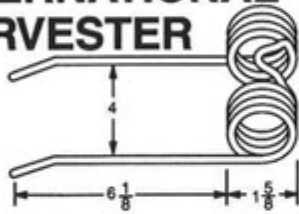

Order No. IH-2B 4.72

MA-74528
U.S. No. IH-2B
Models 45, 45T, 46, 55T, 55W, 435, 445, Balers
Models 15, 16, 55, 350, 550, 650, 200, 36, Forage Harvester
Model 122, 123, 125, 127, 141, 151, 161
Combines .177 Wire, Red
0.5 Lbs. 100/Case

INTERNATIONAL HARVESTER

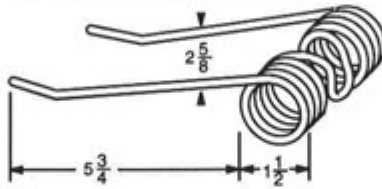

Order No. NI-3 4.27

ZA103012
U.S. No. NI-3 Model 3650
Baler .193 Wire, Black
0.44 Lbs. 100/Case

JOHN DEERE

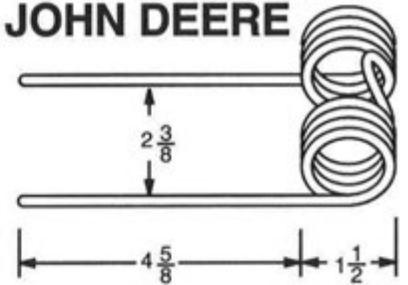

Order No. T16-0025 3.03

E61295 / E67036
U.S. No. JD-1D
Models 410, 430, 500, 510, 530,
Round Balers .187 Wire, Yellow
0.43 Lbs. 100/Case

JOHN DEERE

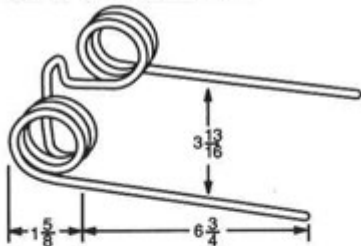

Order No. T16-0022 3.94

276-SE
U.S. No. JD-2B
Models 14T, 24T, 214T Balers
.187 Wire, Green
0.4 Lbs. 100/Case

JOHN DEERE

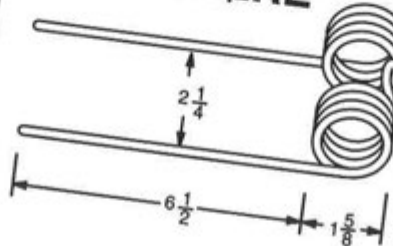

Order No. T16-0024 3.39

E41833
U.S. No. JD-1C
Models 327, 336, 346, 337, 347, 467
Round Balers .177 Wire, Yellow
0.45 Lbs. 100/Case

JOHN DEERE

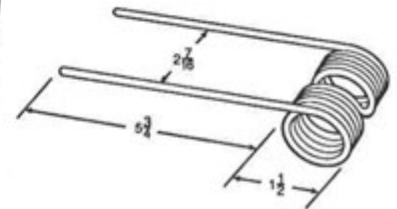

Order No. JD-1D-2 3.76

E-79475
U.S. No. JD-1D-2
Round Balers, 535 Baler
.187 Wire, Green
0.52 Lbs. 100/Case

MASSEY FERGUSON



Order No. T16-0488 7.58

4000-997, 27997-001
Models 1440, 1455, 1550, 1565.
Round Balers. 7"

MASSEY FERGUSON

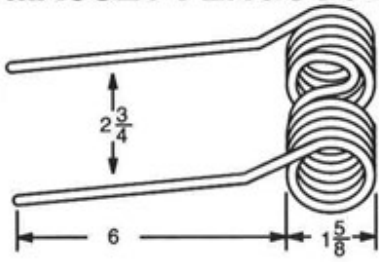

Order No. MF-2B 4.45

151075M2
U.S. No. MF-2B
Balers up to 1958
.187 Wire, Black
0.4 Lbs. Packed 100/Case

NEW HOLLAND

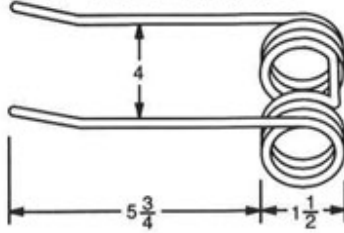

Order No. T16-0158 3.39

127566
U.S. No. NH-1B
Model 78, 67, Super 68, 69,
268, 269, 270 Balers
.187 Wire, Yellow
0.4 Lbs. 100/Case

NEW HOLLAND

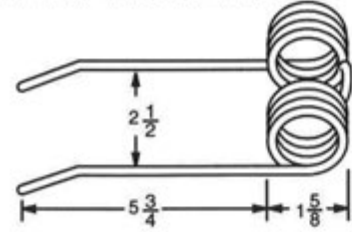

Order No. NH-1D-1 3.76

683310
U.S. No. NH-ID-1
Model 855 Round Baler
up to series 733, 139
.187 Wire, Yellow
0.5 Lbs. 100/Case

MASSEY FERGUSON

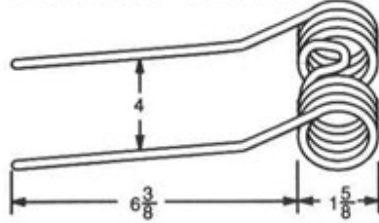

Order No. MF-2C 6.23

665929M1
U.S. No. MF-2C
Models 3, 9, 10, 12 Balers up to 1958
.207 Wire, Black
0.6 Lbs. Packed 100/Case

NEW HOLLAND

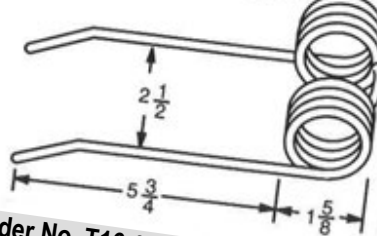

Order No. T16-0162 3.98

131673
U.S. No. NH-1D Replaces 86551419
Models 660, 845, 846, 847, 850, 851, 852
Supersweep & Lg. Round Balers
.187 Wire, Yellow
0.5 Lbs. 100/Case

NEW HOLLAND

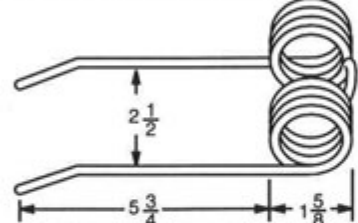

Order No. NH-1D-2 4.47

788853
U.S. No. NH-ID-2
Model 855 Round Baler
Series 733, 140 to 786, 144
.187 Wire, Yellow
0.5 Lbs. 100/Case

NEW HOLLAND

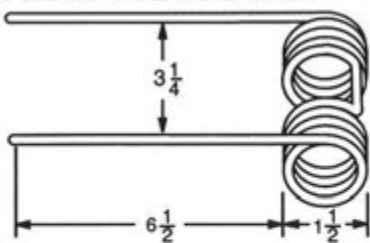

Order No. NH-2C 3.29

28286
U.S. No. NH-2C
Baler .187 Wire, Yellow
0.4 Lbs. 100/Case

NEW IDEA

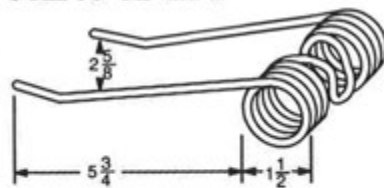

Order No. NI-3 4.27

103012
U.S. No. NI-3
Model 465 and 480, 485, 486,
484, 483.
Round Baler .193 Wire, Black
0.44 Lbs. 100/Case

NEW IDEA

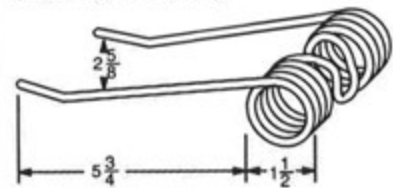

Order No. NI-3 4.27

103012
U.S. No. NI-3
Model 465 and 480, 485, 486,
484, 483.
Round Baler .193 Wire, Black
0.44 Lbs. 100/Case

OWATONNA/OMC

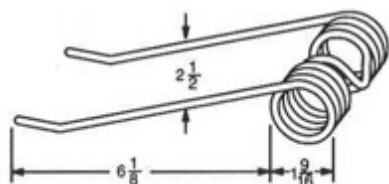

Order No. OW-2 5.99

11032347
U.S. No. OW-2
Models 590, 595, 596
Round Balers .230 Wire, Black
.5 Lbs. 100/Case

VERMEER

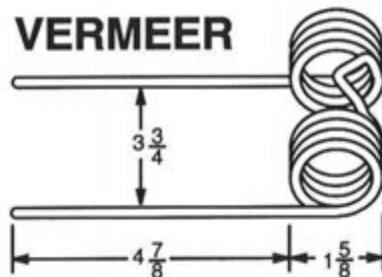

Order No. V-1 4.88

F-413 / 48893001
U.S. No. V-1
B & C Series Balers
.187 Wire, Yellow
0.5 Lbs. 100/Case

VERMEER

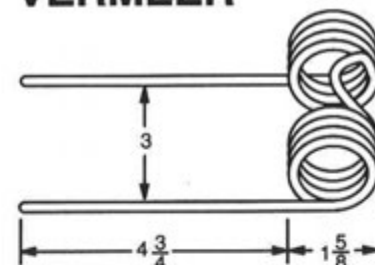

Order No. V-2 4.42

F-1326/29-001
U.S. No. V-2
D Series Baler .187 Wire,
Yellow, 0.5 Lbs. 100/Case

VERMEER

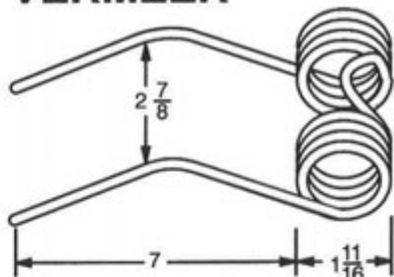

Order No. T16-0485 4.47

4059-001
U.S. No. V-3
E, F, & G Series Balers
.207 Wire, Black
0.6 Lbs. 100/Case

VERMEER



Order No. T16-0488 7.58

4000-997, 27997-001
Models Super F, G, H I, J, K, L, XL
& Rebel Series. 150, 1450, 504,
505/5410, 5410, 5500.
Round Balers. 7"

POLY PICKUP TEETH

Feature a flexible high impact poly. Uses a quarter inch support ring on the inside to strengthen and maintain shape. Mounting hardware included.

- *Won't Bend and Wear Like Steel Ones*
- *Hay Feeds Through Smoothly and Easily*
- *Quieter Operating Baler. No Metal Bands For Pickup Teeth To Rub On.*



Sold In Boxes Of 12. Listed as each.

APPLICATION	OEM PART #	COLOR	ORDER NO	LIST
CASE IH LARGE SQUARE BALER STANDARD CUT MODELS LB333P; LB333S; LB433S; LBX421S; LBX432S; LBX331P; LBX331S; LBX332P; LBX332S; LB334P; LB334S; LB434S	8446827, 84607815, 84801631, 84214800, 84274387	Black	H84801631	43.18
CASE IH; HESSTON; CHALLENGER & NEW IDEA LARGE SQUARE BALERS CIH 8550, 8570, 8575, 8585; CHALLENGER LB33, LB34, LB44; HESSTON 4750, 4755, 4760, 4790, 4910; NEW IDEA 7233, 7234, 7244, 7333	700108607, 700129658	Grey	H700129658	43.18
JOHN DEERE ROUND BALERS 330, 335, 375, 385, 430, 435, 447, 448, 449, 456, 458, 459, 466, 467, 468, 469, 535, 545, 546, 547, 550, 556, 558, 559, 566, 568, 569, 570, 572, 580, 582, 590, 592	CC32669, E85043, FH311772	Green	H311772	43.18
NEW HOLLAND ROUND BALERS 644 (9/95-9/98); 648 (8/98-6/02); 654 (8/95-9/98); 658 (8/98-6/02); 664 (9/95-9/98); 678 (2/99-6/02); 688 (8/98-6/02)	86637149	Yellow	H86637149	43.18
BR730A (9/05-6/07) Prior to P.I.N. Y7N030706; BR740 (10/02-7/05); BR740A (9/05-6/07)	86637149 / 86512793	Yellow	H86637149	43.18
BR7080 (7/07-2/14); BR7090 (7/07-2/14); BR770 (2/03-7/05); BR770A (9/05-6/07); BR780(7/02-7/05); BR780A (9/05-6/07)	87041203	Yellow	H87041203	43.18
BR7060 (7/07-2/14); BR7070 (7/07-2/14); BR7090 (7/07-2/14); BR740 (10/02-7/05); BR740A (9/05-6/07); BR750 (9/02-7/05); BR750A (9/05-6/07); BR780A (9/05-6/07). All with pickup width 70-3/4" first to last tooth	87055364	Yellow	H87055364	43.18
BR7060 (7/07-2/14); BR7070 (7/07-2/14); BR7090 (7/07-2/14); BR740 (10/02-7/05); BR740A (9/05-6/07); BR750 (9/02-7/05); BR750A (9/05-6/07); BR780 (7/02-7/05); BR780A (9/05-6/07). All with pickup width 43" first to last tooth	86643380 86619048	Yellow	H86643380	43.18
NEW HOLLAND LARGE SQUARE BALERS STANDARD CUT BB940AP; BB940S; BB960AS; BB960S; BB960S; BB9080S; BB9060P; BB9070S; BB9340AP; BB940AS; BB940P; BB960S; BB940P; BB940S; BB980; 590; 595; 330P; 330S; 340S	84801630, 89837845, 85005357, 84214799, 84274388; 84468629	Yellow	H84801630	43.18
VERMEER ROUND BALER I, SUPER I, J, SUPERJ, K, L, XL, SUPER M, N RANCHER, REBEL	89962001	Yellow	H89982001	43.18

GATHERING WHEELS

Unique blend of rubber compounds offering durability and performance. The tough rubber fingers resist breakage and provide a longer service life

Make/Model	Description	Order No.	List
CASE-IH			
8450 & 8455	24" x 9" Hub & Wheel 24" x 9" Gathering Wheel	W29-0400 W29-0405	438.05 171.98
GEHL			
1500, 1600, 1850, 1860	28" x 12 Gathering Wheel	W29-0415	219.76
HESSTON			
530, 540, 745	24" x 9" Hub & Wheel Replacement Wheel	W29-0400 W29-0405	438.05 171.98
550, 555, 560, 565	Wheel Wedge (3 per wheel)	W29-0410	51.76
5540 & 5545	Wheel Wedge (3 per wheel)	W29-0410	51.76
5580 & 5585	Wheel Wedge (3 per wheel)	W29-0410	51.76
JOHN DEERE			
430, 435, 466, 467	Wheel Wedge (3 per wheel)	W29-0410	51.76
MASSEY FERGUSON			
1560, 1745	24" x 9" Gathering Wheel	W29-0405	171.98
NEW HOLLAND			
640, 648, 660, 688	28" x 12 Gathering Wheel	W29-0415	219.76
VERMEER			
504 I, 504 L, 504 SI, 505 I, 504 SI, 554 XL, 555 XL, 604 J, 604 K, 605 J, 605 K, 604 L, 605L, 605 SJ, 604 SJ, 604 XL, 605 XL, 5400 Rebel, 5410 Rebel, 5420 Rebel, 5500 Rebel, 5520 Rebel, 540 M Classic, 664 Rancher, 665 Rancher, 6640 Rancher, 6650 Rancher	24" x 9" Gathering Wheel	W29-0405	171.98
504 F, 504 G, 504 H, 605 F, 605G, 605H	28" x 12" Gathering Wheel	W29-0415	219.76



W29-0400

HUB AND GATHERING WHEEL ASSEMBLY

Gathering wheel hub and wheel assemblies are available to replace older style wheels commonly found on many earlier baler models. Wheel assembly can be mounted on either side by simply loosening the bolts and reversing the hub assembly. Bearings not included.

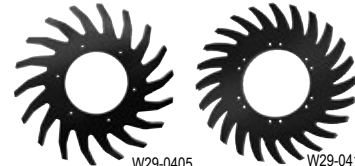

W29-0405

W29-0415

GATHERING WHEEL

Wheels provide the reliable performance you expect from OEM quality gathering wheel. Bolt holes are pre-punched for ease of installation and offered pattern fits most balers equipped for this wheel style.



W29-0410

WHEEL WEDGE

Die-cut from 4-ply 440 1/4" x 1/16" grade 2 industrial conveyor belt, three segments can be combined to make a single wheel. Segments provide a durable and economical wheel option and is ideal for certain older model balers.

DISC MOWER KNIVES

DISC MOWER SPECIFICATIONS

Application		Shape	Degree Of Twist	Length	Width	Thickness	Hole Diameter	Center Of Hole To Back Edge	Order No.
Gehl, John Deere, Kuhn, NH	LH	Twisted	13	3.75	1.78	0.140	0.64	0.75	B45-6122D
Gehl, John Deere, Kuhn, NH	RH	Twisted	13	3.76	1.72	0.130	0.64	0.78	B45-6123D
New Holland, Kuhn	Both	Flat	0	3.78	1.55	0.110	0.64	0.71	B45-6175D
CIH, Gehl, MF, New Idea, Vicon	LH	Twisted	13	4.21	1.86	0.157	0.73	0.78	B45-6559D
CIH, Gehl, MF, New Idea, Vicon	RH	Twisted	13	4.21	1.86	0.157	0.73	0.78	B45-6560D
Bush Hog, Hesston	RH	Twisted	13	4.76	1.88	0.165	0.89	0.78	B45-6563D
Bush Hog, Hesston	LH	Twisted	13	4.76	1.88	0.165	0.89	0.78	B45-6564D
Kuhn, Gehl, John Deere, NH	LH	Twisted	13	4.72	1.79	0.170	0.73	0.78	B45-6565D
Kuhn, Gehl, John Deere, NH	RH	Twisted	13	4.72	1.79	0.170	0.73	0.78	B45-6566D
Hesston, Kuhn, Gehl, John Deere, NH	RH	Twisted	13	4.21	1.78	0.169	0.72	0.80	B45-6568D
Hesston, Kuhn, Gehl, John Deere, NH	LH	Twisted	13	4.21	1.78	0.169	0.72	0.80	B45-6569D
CNH, Hesston	LH	Twisted	18	4.21	1.88	0.163	0.73	0.78	B45-6572D
CNH, Hesston	RH	Twisted	18	4.21	1.88	0.163	0.73	0.78	B45-6573D
CNH, Bush Hog, New Idea, MF	LH	Twisted	18	4.76	1.88	0.165	0.89	0.78	B45-6576D
CNH, Bush Hog, New Idea, MF	RH	Twisted	18	4.76	1.88	0.165	0.89	0.78	B45-6577D
CNH, Bush Hog, New Idea, MF	RH	Twisted	18	4.44	1.88	0.157	0.89	0.80	B45-6578D
CNH, Bush Hog, New Idea, MF	LH	Twisted	18	4.44	1.88	0.157	0.89	0.80	B45-6579D
Kuhn	Both	Flat	0	3.27	1.58	0.118	0.75	0.62	B45-6702D
Fella	LH	Twisted	13	3.86	1.86	0.160	0.75	0.83	B45-6703D
Fella	RH	Twisted	13	3.86	1.86	0.160	0.75	0.83	B45-6704D
CNH, New Holland	RH	Twisted	13	4.21	1.90	0.160	0.89	0.75	B45-6720D
CNH, New Holland	LH	Twisted	13	4.21	1.90	0.160	0.89	0.75	B45-6721D
Krone	LH	Twisted	13	4.41	1.90	0.166	0.75	0.76	B45-6722D
Krone	RH	Twisted	13	4.41	1.90	0.166	0.75	0.76	B45-6723D
CNH, Hesston	LH	Twisted	18	4.21	1.89	0.157	0.73	0.75	B45-6725D
CNH, Hesston	RH	Twisted	18	4.21	1.89	0.157	0.73	0.75	B45-6726D
M&W, Sitrex	LH	Twisted	13	3.88	1.75	0.145	0.80	0.78	B45-6737D
M&W, Sitrex	RH	Twisted	13	3.88	1.75	0.145	0.80	0.78	B45-6738D
Reese	LH	Twisted	13	3.99	1.88	0.157	0.80	0.80	B45-6741
Reese	RH	Twisted	13	3.99	1.88	0.157	0.80	0.80	B45-6742
									B45-6750
									B45-6751
Mortl	RH	Twisted	13	3.65	1.88	0.116	0.92	0.80	B45-6760D
Mortl	LH	Twisted	13	3.65	1.88	0.116	0.92	0.80	B45-6761D
Bush Hog, Beal, CIH, Fella, Gehl, Lely, MF, New Idea, Vicon,	LH	Twisted	13	4.72	1.86	0.163	0.73	0.78	B45-6992D
Bush Hog, Beal, CIH, Fella, Gehl, Lely, MF, New Idea, Vicon,	RH	Twisted	13	4.72	1.86	0.163	0.73	0.78	B45-6993D
Hesston, Kuhn, John Deere, NH	LH	Twisted	13	3.66	1.58	0.116	0.64	0.80	B45-6996D
Hesston, Kuhn, John Deere, NH	RH	Twisted	13	3.66	1.60	0.116	0.64	0.67	B45-6997D
Krone, Fahr, Fella, PZ Zweegers, Welger	Both	Flat	0	3.78	1.64	0.125	0.75	0.75	B45-6998D

DISC MOWER BLADE BOLTS AND NUTS

6 bolts & 6 nuts per blister box



B55-0340D



B55-0344D



B55-0357D



B55-0356D



B55-0358D

Replaces Number	Mfr. Name	Description / Application	Order No	List
561.501.00	Kuhn	For GMD41, 44, 55, 66, 240, 260, 452	B55-0340D	18.60
CC19334	John Deere	240, 260, 1320, 1326, 1327		
561.158.00	Kuhn	Heavy Duty, for CMD 500, 600, 801, FC250, 300, GMD66HD, GMD77HD	B55-0344D	32.56
527745K	New Idea	DM5406, 5407, 5408, 5409, 5410, 5209, 5212, MC136	B55-0357D	37.44
1377.26.6	Krone	Includes 141.053.4 Bolt & 909.602.1 Nut	B55-0356D	33.95
BK001	Bush Hog	DM70, 80, 90, 180, 190	B55-0355D	68.61
527745K	Case/IH	3204, 3205, 3206, 3309		
	Hesston/MF	1006, 1007, 1306 - 1310, 1326 - 1330		
	New Idea	526, 527, 528, 5207, 5209		
CC19929K	John Deere	1320, 1326, 1327, 240, 260	B55-0358D	17.24
562.101.00	Kuhn	GMD44, 55, 66		
5621010015	New Holland	442, 452, 462		
87515925	New Holland 1" Bolt	W/O Lifters. 615, 616, 617, 720HD, 750HD, 1409, 1410, 1411, 1412, 1431, 1432, 1441, 1442, 2331, 2332, 2353, 2355, 2358, DCX101, DCX131, DCX161, RDX161, H6730, H6740, H6750, H7220, H72230H, H7320, H7330	B55-0359D	40.96
8651926	New Holland 1.75" Bolt	With Lifters. 615, 616, 617, 720HD, 750HD, 1409, 1410, 1411, 1412, 1431, 1432, 1441, 1442, 2331, 2332, 2353, 2355, 2358, DCX101, DCX131, DCX161, RDX161, H6730, H6740, H6750, H7220, H72230H, H7320, H7330	B55-0360D	52.33

DISC MOWER KNIVES

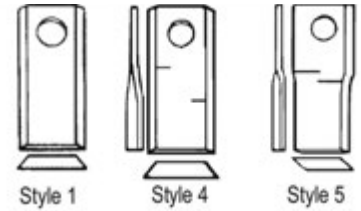

OEM Number	Application	Length Inches	Dia. Inches	Style	Shape	Bolt Order No	6 Blades Order No	List	25 Blades Order No	List
NEW IDEA										
527746	5209, 5212, 5312, 5406, 5407, 5408,	4.76	.890"	5	RH Twisted	B55-0355D	B45-6563D	16.05	B45-6563	62.90
527747	5409, 5410,	4.76	.890"	5	LH Twisted	B55-0355D	B45-6564D	16.05	B45-6564	62.90
526216	5209, 5212, 5406, 5407, 5408, 5409, 5410,	4.72	.728"	5	LH Twisted	B55-0357D	B45-6992D	16.91	B45-6992	63.76
526215	526, 527, 528	4.72	.728"	5	RH Twisted	B55-0357D	B45-6993D	16.91	B45-6993	63.76
	5070, 5512, 5515, 6070	4.21	.728"	5	LH Twisted	B55-0342D	B45-6560D	14.35	B45-6560	57.98
		4.21	.728"	5	RH Twisted	B55-0342D	B45-6559D	14.35	B45-6559	57.98
700712888		4.21	.717"	4	RH Twisted	B55-0344D	B45-6568D	15.03	B45-6568	59.94
700712889		4.21	.717"	4	LH Twisted	B55-0344D	B45-6569D	15.03	B45-6569	59.94
POTTINGER										
700.06.1650		3.78	.748"	1	Flat	N/A	B45-6998D	15.56	B45-6998	54.42
PZ ZWEEGERS										
DM155, DM303	230, 265, 275, 320	3.66	.640"	4	LH Twisted	B55-0358D	B45-6996D	15.56	B45-6996	46.70
DM160, DM304		3.66	.640"	4	RH Twisted	B55-0358D	B45-6997D	15.56	B45-6997	54.42
MT452S		3.78	.748"	1	Flat	N/A	B45-6998D	15.56	B45-6998	54.42
REESE										
		3.99	.80	5	LH Twisted	N/A			B45-6741	59.51
		3.99	.80	5	RH Twisted	N/A			B45-6742	59.51
VERMEER										
DM303	230, 275, 320	3.66	.640"	4	LH Twisted	B55-0358D	B45-6996D	15.56	B45-6996	46.70
DM304		3.66	.640"	4	RH Twisted	B55-0358D	B45-6997D	15.56	B45-6997	54.42
VICON										
902-58699	AM3200, CM165, CM167, CM240, CM247,	4.72	.728"	5	LH Twisted	B55-0357D	B45-6992D	16.91	B45-6992	63.76
902-58700	CM1700, KM240, KM241, KM281, KM321, CM2400, DMP2400, DMP3200, KM3200, KM4000, KMR3800, KMT3001	4.72	.728"	5	RH Twisted	B55-0357D	B45-6993D	16.91	B45-6993	63.76
902-61559	CM216, CM217, OM216, OM281, KM216,	4.21	.728"	5	LH Twisted	B55-0342D	B45-6559D	14.35	B45-6559	57.98
902-61560	KM281, KM391LP, GMR2800, CM2200, AM2800	4.21	.728"	5	RH Twisted	B55-0342D	B45-6560D	14.35	B45-6560	57.98
902-61559	CM2800, DMP2800, KM2800	4.21	.717"	4	RH Twisted	B55-0344D	B45-6568D	15.03	B45-6568	59.94
WELGER										
0982.15.06.00		3.78	.748"	1	Flat	N/A	B45-6998D	15.56	B45-6998	54.42
3208.01.03.44		3.78	.748"	1	Flat	N/A	B45-6998D	15.56	B45-6998	54.42

ROTARY MOWER TAIL WHEELS

OEM Quality. Fits Most major Brands
Including: Bush Hog, John Deere, LandPride, Rhino and More.

• Forged Yokes for added strength. • All parts zinc or powder coated.

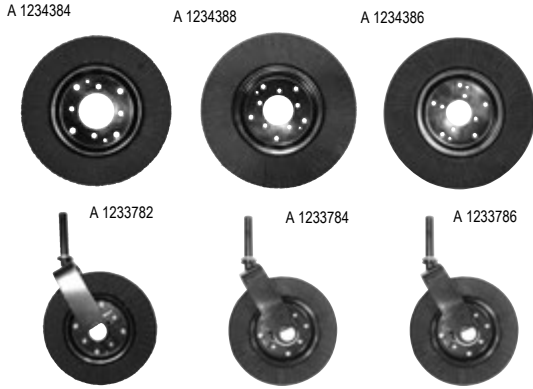

Description	Order No.	List
4x8 4 Bolt Rim w/15 x 4 Laminated Tire	A 1234384	85.07
6x9 4 Bolt Rim w/21 x 5.5 Laminated Tire	A 1234386	218.56
6x9 5 Bolt Rim w/21 x 5.5 Laminated Tire	A 1234388	218.56
Complete Tail Wheel Assembly. 4" x 8". 1-1/4" Diameter Yoke w/Cast Hub & Bushings	A 1233782	184.50
Complete Tail Wheel Assembly. 4" x 8". 1-1/4" Diameter Yoke w/Cast Hub & Bearings	A 1233784	209.00
Complete Tail Wheel Assembly. 6" x 9". 1-1/2" Diameter Yoke w/Cast Hub & Bearings	A 1233786	225.69

ROTARY MOWER WHEEL PARTS

OEM Quality. Fits Most major Brands Including: Bush Hog, John Deere, LandPride, Rhino and More. All parts zinc or powder coated.



Type	Description	Used On	Order No.	List
Axle Bolt	3/4 x 8" Clipped Head Axle Bolt w/Castle Nut	A 1233782, A 1233784 & A 1233786	A 1234370	19.65
Bushing	3/4". For cast and fabricated hubs		A 1234377	6.67
Bushing	1". For cast and fabricated hubs		A 1234379	8.20
Hub	Cast Hub w/1" I.D. Bushings		A 1234371	29.21
Hub	Cast Hub w/3/4" I.D. Bushings	A 1233782	A 1234372	31.44
Hub	Cast Hub w/3/4" Bearings & Weed Guards. 510	A 1233784 & A 1234373	A 1234373	76.78
Hub	Fabricated Hub w/1" I.D. Bushings		A 1234374	34.12
Hub	Fabricated Hub w/3/4" I.D. Bushings.		A 1234375	34.12
Rebuild Kit	Includes 2 caps, 2 bearing/races, 2 step bushings and 2 seals		A 1234385	58.34
Yoke	1-1/2" Yoke diameter. For 3/4" axles		A 1234382	73.27
Yoke	1-1/4" Yoke diameter. For 3/4" axles		A 1234383	62.18

All Hubs Include Lug Bolts.

FINISH MOWER PARTS

OEM Quality. Fits Most Major Brands.

Description	Order No.	List
3.25" x 10" Finish Mower Assembly	A 1233781	122.51
1" Diameter Yoke. 8.5" Long		
Solid Molded Finish Mower Tire w/rim	A 1234378	84.78

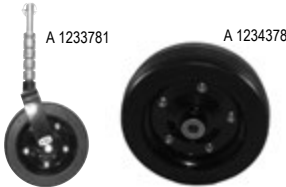

25" LAMINATED WHEEL WITH TREAD PATTERN.

Laminated wheel was designed to take the place of the used foam filled aircraft tires on Rotary Mowers. It has been field tested 3,000 + hours. No foam to break down, no air to go flat. Takes the place of 21" laminated tires for increased height and it has a tread pattern for better traction.



WIDTH INCHES: 6.25"
TIRE SIZE INCHES: 25" Diameter
CAPACITY LBS: 2000
HUB BOLT PATTERN: 5 on 5.5" centered
CENTER HUB HOLE: 4" diameter
TIRE DESIGN: Laminated with tread pattern
WEIGHT LBS: 119 LBS each

Order No.	List
A 1234390	463.22



5 PC. FINISH MOWER ASSEMBLY SPACERS

Includes (4) 1" and (1) 1/2" spacers.

Order No.	List
A 1234381	38.38



3 PC. STEP DOWN BUSHING

3/4" x 1/2". Includes 2 bushings and 1 sleeve.

Order No.	List
A 1234369	16.28

PTO SHAFT ASSEMBLIES - METRIC

FLEX WING MOWERS

COMPLETE MAIN DRIVELINES W/CV JOINT*

BUSH HOG® MODEL NO.: 2415, 2515, 2615, 2720 & 3615

Tractor Yoke	Clamp Yoke	Series	Replaces	Order No.	List
1 3/8" x 6 Spl.	1 3/4" x 20 Spl.	BYPY8	14516855	BP855620CV	779.39
1 3/8" x 21 Spl.	1 3/4" x 20 Spl.	BYPY8	14616855	BP8552120CV	779.39
1 3/4" x 20 Spl.	1 3/4" x 20 Spl.	BYPY8	14716855	BP8552020CV	779.39

OVERALL COMPRESSED LENGTH - 55"

RHINO® MODEL NO.: SR-15, SE-15

Tractor Yoke	Clamp Yoke	Series	Replaces	Order No.	List
1 3/8" x 21 Spl.	1 3/4" x 20 Spl.	BYPY8	14606851	BP8512120CV	779.39

OVERALL COMPRESSED LENGTH - 51"

DEERE® MODEL NO.: 1517, 1518, 2018

Tractor Yoke	Clamp Yoke	Series	Replaces	Order No.	List
1 3/8" x 6 Spl.	1 3/4" x 20 Spl.	BYPY8	14516855	BP855620CV	779.39
1 3/8" x 21 Spl.	1 3/4" x 20 Spl.	BYPY8	14616855	BP8552120CV	779.39
1 3/4" x 20 Spl.	1 3/4" x 20 Spl.	BYPY8	14716855	BP8552020CV	779.39

OVERALL COMPRESSED LENGTH - 55"

FLEX WING MOWERS

COMPLETE WING DRIVELINES W/FRICTION CLUTCH*

BUSH HOG®

Yoke	Clutch Yoke	OAL Compressed	Replaces #	Order No.	List
1-3/8X6 SPL.	1-3/4X20 SPL.	64.11	14106660	BP661620C	649.52
1-3/4X20 SPL.	1-3/4X20 SPL.	63.18	14106661	BP6632020C	652.06

BUSH HOG®, JOHN DEERE AND SCHULTE

Yoke	Clutch Yoke	OAL Compressed	Replaces #	Order No.	List
1-3/4X20 SPL.	1-3/4X20 SPL.	64.11	14106664	BP6642020C	777.13

ALL PURPOSE

TRACTOR YOKE	IMPLEMENT YOKE	OAL COMPRESSED	REPLACES	SERIES	ORDER NO	List
1-3/8X6 SPL. QD	1-3/8X6 SPL. QD	47"	14006247	BYPY2	BP24766	188.31
1-3/8X6 SPL. QD	1-3/8X6 SPL. QD	48"	14006448	BYPY4	BP44866	201.88
1-3/8X6 SPL. QD	1-3/8X6 SPL. QD	55"	14006455	BYPY4	BP45566	206.89
1-3/8X6 SPL. QD	1-3/8X6 SPL. QD	57"	14006657	BYPY6	BP65766	332.66

DISC MOWER

TRACTOR YOKE	IMPLEMENT YOKE	OAL COMPRESSED	REPLACES	SERIES	ORDER NO	List
1-3/8X6 SPL. QD	1-3/8X6 SPL. W/OVERRUNNING CLUTCH	39"	14306639	BYPY6	BP63966C	345.44

FERTILIZER SPREADER

TRACTOR YOKE	IMPLEMENT YOKE	OAL COMPRESSED	REPLACES	SERIES	ORDER NO	List
1-3/8X6 SPL. QD	1-3/8X6 SPL. QD	27"	14006127	BYPY1	BP12766	114.46

FINISHING MOWER

TRACTOR YOKE	IMPLEMENT YOKE	OAL COMPRESSED	REPLACES	SERIES	ORDER NO	List
1-3/8X6 SPL. QD	1-3/8X6 SPL. QD	37"	14006637	BYPY6	BP63766	237.91

ROTARY CUTTER

TRACTOR YOKE	IMPLEMENT YOKE	OAL COMPRESSED	REPLACES	SERIES	ORDER NO	List
1-3/8X6 SPL. QD	1-3/8 ROUND W/PINHOLE	36"	14006436	BYPY4	BP4366R	211.51
1-3/8X6 SPL. QD	1-3/8 ROUND W/PINHOLE	42"	14006442	BYPY4	BP4426R	217.77
1-3/8X6 SPL. QD	1-3/8 ROUND W/PINHOLE	52"	14006542	BYPY5	BP55266	281.63

ROTARY MOWER

Exclusive Factory Testing For Maximum Field Performance!

- **SHOT PEEN TESTED:** To Reduce Stress In The Blade And Increase Flexibility.
- **CHARPY TESTED:** An Impact Test To Reduce Breakage
- **STEEL CHEMISTRY TESTED:** The Chemistry For The Steel In Our Blades Is Not Only Tested Once, But Twice To Ensure Only The Best Steel Is Used.
- Painted Black For Maximum Shelf Appeal
- Manufactured From High Quality 5160 High Carbon Steel
- OEM Quality



JOHN DEERE

Replaces	Blade Rotation	Application	Length	Overall Width	Blade ness	Thick-Size	Hole Bolt Used	Order No.	List
W43466	CCW	509, 609, 709, 727, 737, 1008, 1508, 1517, 1518, 2018	21-3/4	4	1/2	1-1/2	B55-0353	B45-5030	33.08
W43465	CW	727, 737, 1008, 1018, 1508, 1517, 1518, 2018	21-3/4	4	1/2	1-1/2	B55-0353	B45-5031	33.08

LAND PRIDE

Replaces	Blade Rotation	Application	Length	Overall Width	Blade ness	Thick-Size	Hole Bolt Used	Order No.	List
820170C	CW	RCB6015, RC(M)5015, 6015	23	4	1/2	1-1/2	B55-0348	HA820170C	35.06

SCHULTE

Replaces	Blade Rotation	Application	Length	Overall Width	Blade ness	Thick-Size	Hole Bolt Used	Order No.	List
401028	CCW	5026 CENTER, 5026RH INNER, V1280RH	27-3/4	4	1/2	1-1/2	B55-0361	HA401028	46.13



B55-0348

B55-0350

B55-0353

B55-0360

B55-0332

B55-0361

B55-0358

B55-0362

ROTARY BLADE BOLTS

Description	Replaces Number	Application	Thread Specification	Order No.	List
Bolt Kit	802-277C, 41-052-0005, 12-180, 1-219, 6T1022	Great Plains, KMC, Mohawk, Tiger	1-1/8 12 UNF	B55-0348	21.36
Bolt Kit	HL418N	Howse New style bolt w/square shoulder	1-1/8 12 UNF	B55-0350	9.41
Bolt Kit	W22237	JD 509, 609, 709, 1508	1-1/8 12 UNF w/stake key	B55-0353	19.25
Bolt Only	W38054	JD XH, MX, CX, XLX series. 506, 606, 613, 616, 717, 1517	1 14 UNF	B55-0360	9.41
Bolt & Nut	57-104-4 Nut #5 GL-16-140	Servis Rhino Cyclone 60, 72, 84, 128, Flex 15, Gyro 60, 72, 84, 128, 160, 1310	1 14 UNF LH	B55-0332	22.49
Bolt Only	251-0007	Schulte 5026, 5100, 5150, V1280, XH1000, XH1500	1-1/8 UNF	B55-0361	14.45
Bolt Only	8227	Terrain King AG84B, A101V, A151V,	1 14 UNF RH	B55-0358	20.55
Bolt Only	32616	Woods 2120, 2162, 3180, 3240	Bolt has groove for a pin clamp assembly	B55-0362	17.47

EASY RICER CUTTERBAR KITS & PARTS

Replaces Number	Size	Description	Application	Order No	List
MC468		Wear Plate	All Easy Ricer Applications	P44-0417	3.00
		Adjustable Clip-Lo Arch	All Easy Ricer Applications	C45-0041	10.71
2TC-14S	25/Box	XHTS Miniature Section. 2". 1-1/4" Hole Spacing. 2-3/4" Long. With Slot. Bottom Countersunk		S20-3404P	44.96
2TC	25/Box	XH7TS-Miniature Section. 2". 1-1/4" Hole Spacing. 2-3/4" Long. With Slot. Bottom Countersunk.	All Easy Ricer Kits Lower Seg.	S20-3521P	44.96
SSL192D	10/Box	XH7 TS-Rice Section. No Slot	All Easy Ricers Except Mac Don	S20-3370	22.70
L192DCR	10/Box	XH TS CR Section. No Slot		S20-4608	27.87
0922CB	10/Box	XH TS Section. No Slot		S20-3364	27.31
H300	10/Box	XHTS Section. 3" x 2-3/4". No Slot		S20-3405	27.86
9/16 CSZP	1#	9/16" Rivet, 1 lb./BB	All	R36-0469D	14.10

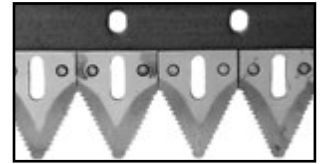

- Simple bolt-on conversion
- Time and money savings
- Faster ground speed, especially in down and tangled rice.

Easy Ricer packages are complete cutterbar conversion kits. Kits include: Full length riveted sickle (less drive head) with black 14-tooth sections, lower segments (to replace guards), adjustable hold down clips, wear plates, and hardware.

COMBINE TEETH



COMBINE PICKUP REEL
For Combines and Pickup reels. Replaces H1611. Steel. 100 per box. MFR: Hume

Order No. List
T16-0124 1.90



4.5" NYLON FLEX TINE
Replaces N66A. 1 mounts to front of wood bat. 100 per box.

Order No. List
T16-0183 225.49



4.5" NYLON FLEX TINE
Replaces H127035, 71345318, 27631J6M1, 197058C, 786031. 1 mounts to rear of tear drop steel bat. 100 per box.

Order No. List
T16-0767 190.20



2 PIECE M/L REEL TINE
Replaces 782551, 1989438C1, AH136689, AH153175. 100 per box. With clamps and screws for 4.5" spacing.

Order No. List
T16-0720 251.62



2 PIECE M/L REEL TINE
Replaces 782226, 1989438C1, AH136689, AH153175. 10 per bag. With clamps and screws for 4.5" spacing.

Order No. List
T16-0715 23.22



4.5" M/L REEL TINE
For T16-0715 and T16-0720. No clamps. Replaces HA100MLT. 100 per box.

Order No. List
T16-0725 147.75

COMBINE/TIGER JAW

TIGER JAW® SPLICED SICKLES - DOUBLE DRIVE (LESS HEAD) - 1.5" SYSTEMS - ALSO FITS NH 1.5" SYSTEMS

Bolted Super 7

OEM Number	Section Number	H7TSCR No. Of Sections	Size	Segments				2.5' Ext. Seg. S35-2511	5' Ext. Seg. S35-2277	Complete Sickle Order No	List
				5'LH Head Seg. S35-2507	5'LH Overlap Seg. S35-2508	5'RH Head Seg. S35-2509	5'RH Overlap Seg. S35-2510				
9842587	SSTJ6700	50	25'LH	1	1	-	-	1	-	S35-2503	508.19
9820457	SSTJ6700	58	30'RH	-	-	1	1	-	1	S35-2506	490.51

Use H15-0060 LH Head, H15-0061 RH Head if needed. (For Tiger Jaw applications only.) Use H15-0752 Head if needed. (For OEM 1.5" Systems only.)

TIGER JAW® REPLACEMENT SICKLES - Bolted with Super 7 Sections

Replaces					Replaces				
Number	Size	Application	Order No	List	Number	Size	Application	Order No	List
1-Piece Universal with Super 7 sections					Spliced Universal with Super 7 sections				
TJ4-U2000	4'	All TJ Kits - Less Head	S35-2860	107.59	TJ4-U2000	4'	All TJ Kits - Less Head	S35-2860	107.59
TJ5-U2000	5'	w/2" Hole Spacing	S35-2276	138.98	TJ5-U2000	5'	w/2" Hole Spacing	S35-2276	138.98
TJS16-U2000	16'	In Knife Back	S35-2153	458.01	TJ8-U2000	8'	In Knife Back	S35-2861	183.92
TJS20-U2000	20'		S35-2155	560.55	TJ8.5-U2000	8.5'	Head Segment	S35-2862	185.10
TJ4-U2116	4'	All TJ Kits- Less Head	S35-2271	107.59	TJ4-U2116	4'	All TJ Kits - Less Head	S35-2271	107.59
TJ5-U2116	5'	w/2-1/16" Hole Spacing	S35-2277	147.03	TJ5-U2116	5'	w/2-1/16" Hole Spacing	S35-2277	147.03
TJS16-U2116	16'	In Knife Back	S35-2154	457.84	TJ8-U2116	8'	In Knife Back	S35-2858	180.36
TJS20-U2116	20'		S35-2156	554.90	TJ8.5-U2116	8.5'	Head Segment	S35-2859	185.10

For both the original Tiger Jaws and Tiger Jaws 2000 series.

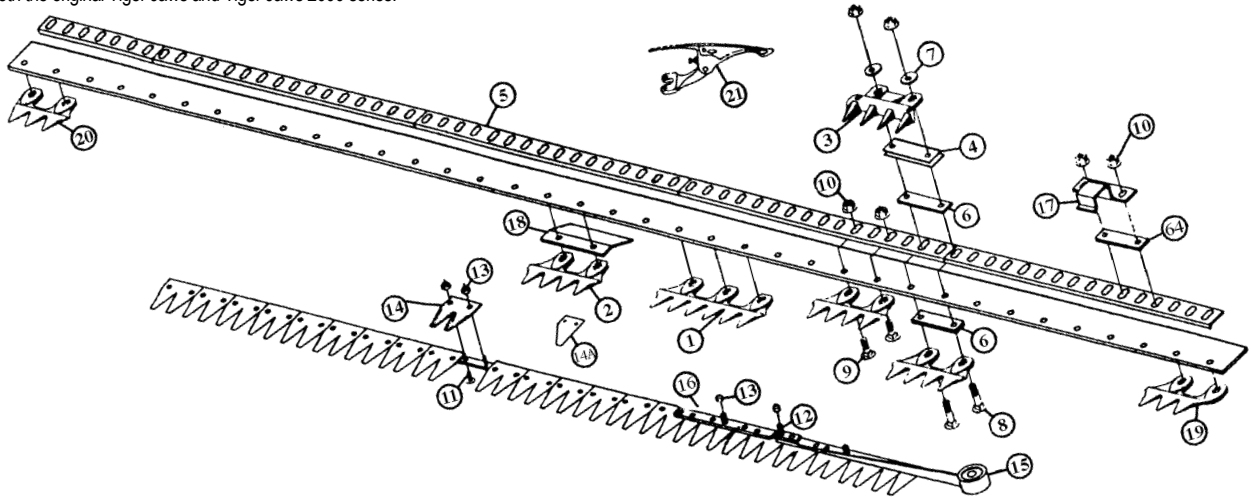

Key Code Number	OEM Number	Description	Pkg Qty	Order No	List
2	TJ44 - 4A	Guard, 4 Point All Except IHC 1020	Each	G81-0581	24.17
NI	N/A	Clip Kit, Adjustable, 3/8" Hardware (New Style). Lock Nut	Each	C45-0003	27.26
NI	N/A	Clip Kit, Adjustable, 7/16" Hardware (New Style)	Each	C45-0004	25.18
NI	N/A	Clip Adjuster, 2 Used per Clip (New Style)	Each	C45-0001	4.80
NI	N/A	Clip, Steel, Adjustable Hold Down (New Style)	Each	C45-0002	16.24
5	FLW24HT	2 Ft. Wear Plate, Heat Treated	Each	P44-0200	17.71
5	TJ11WP	Wear Plate, 1 Foot, Heat Treated, IHC 1020 Only	Each	P44-0660	10.13
8	TJ214SBN	Carriage Bolt, Special 3/8" x 2-1/4" w/7/16" Head w/Nut - JD	25/Bag	B55-0203	43.65
11	TJ55BN50	Section Bolt & Nut, 5/8"	50/BB	B55-0065D	12.28
12	TJ85BN	Head Bolt & Nut, 1"	15/BB	B55-0085D	7.31
12	TJ95BN	Head Bolt & Nut, 1 - 1/4"	12/BB	B55-0095D	7.51
14	SSTJ6700	Section, Universal, Fits 2" & 2-1/6" Hole Spacing - Super Seven	10/BB	S20-4409	25.87
14	SSTJ6000	Section, 2" Hole Spacing - Super Seven	10/BB	S20-4316	27.28
14	TJ6000	Section, 2" Hole Spacing	10/BB	S20-4638	24.64
14	SSTJ7000	Section, 2-1/16" Hole Spacing - Super Seven	10/BB	S20-4317	27.28
14	TJ7000	Section, 2-1/16" Hole Spacing	10/BB	S20-4639	27.29
14A	TJ1200	Half Section	10/BB	S20-0297	36.74
15	71358960	Sickle Head AC Series 3 & 300	Each	H15-0228	120.24
15	180859C91	Sickle Head, (AC, IH, MR) w/Hart Carter Gen III Floating Cutterbar	Each	H15-0194	138.04
15	AH89498	Sickle Head, John Deere 900 Series After 1996	Each	H15-0004	140.71
17	B5H500	High Arch Hold Down	Each	C45-0693	7.45
NI*		IH 820 Head	Each	H15-0640	299.59
NI*		810 Flex Head	Each	H15-0194	138.04

NI* - Not Illustrated N/A - Not Applicable

SPLICE KITS

Description	Order No	List
Splice Kit w/bolts & nuts, 2" Spacing	C83-0750	26.70
Splice Kit w/bolts & nuts, 2-1/16" Spacing	C83-0755	26.70
Bolt & Nut Kit for Spliced Sickles, 12/BB	B55-0049D	11.36

A	
Air Seeder Spoons	170
Alfalfa Spikes	173
Ammonia Knives	177
Anhydrous Knives	177
Application Charts, Tillage	140 - 141
B	
Bearing, Disc	155 - 158
Bearing, Drill Disc	155
Bearings, Gauge Wheel	162
Blades, Disc	152 - 153
Blades, Drill Disc	178
Blades, Harrow	152 - 153
Blades, Peanut	171
Bolts, Plow	146
C	
Caps, Ripper	175
Caps, Subsoiler	175
Chain, Covering	178
Chisel Plow Sweeps	172, 173
Chisel Points	173 - 174
Chisel Sweeps	172, 173
Chrome Plated Plow Bolts	146
Clipped Head Bolt	148
Clips, Hammer Lock	146, 170
Concave Coulters	151
Cone Style Disc Blades	152
Conservation Points	175
Cotton Stalk Puller Blade	154
Coulters	151
Covering Chain	178
Cultivator Gauge Tires	162
Cultivator Gauge Wheel Bearings	162
Cut Out Disc Blades	152 - 153
D	
Danish Bolts	146
Danish Sweeps	172
Danish Tine Clamps	172
Danish Tines	172
Disc Axles	161
Disc Bearings	155 - 158
Disc Blade Application Charts	140
Disc Blade Terminology	139
Disc Blade Warranty Policy	139
Disc Blades	152 - 153
Disc Blades, Cone Style	152
Disc Blades, Flat Center	153
Disc Blades, Special Concavity	153
Disc Replacement Parts	162
Double Disc Openers	178 - 179
Drill Disc Assemblies	178 - 179
Drill Disc Bearings	179
Drill Disc Blades	179
Drill Disc Parts	178 - 179
Drill Points	178
Dust Caps, Drill Disc	179
Dust Caps, Grain Drill	179
E	
Elliptical Head Bolts	146
F	
Fertilizer Knives	177
Fertilizer Tubes	177
Ferobide	176
Field Cultivator Sweeps	169
Flat Center Disc Blades	153
Flat Coulters	151
Fluted Coulters	151
Furrowers	170
G	
Gauge Wheel Bearings	162
Gauge Wheel Tires	162
Gauge Wheels	162
Grain Drill Covering Chains	178
Grain Drill Disc Assemblies	178 - 179
Grain Drill Parts	179
Grain Drill Points	178

G continued	
Graphite	168
Grass Knife, NH3	177
Ground Hog Knife	177
H	
Hammer-Lock Sweeps	170
Hardware	148
Hardware, Drill Disc	179
Harrow Blades	? - ?
Harrow Tines	177
J	
Joyce Sweeps	171
K	
Knives, Ammonia	177
Knives, Anhydrous	177
Knives, Fertilizer	177
Knock On Sweeps	170
L	
Landsides	148
Lister Style Furrowers	170
M	
Modular Knife, NH3	177
Moldboard Plow Parts	147
Moldboard Plow Information	127 - 138
Moldboards, Plow	147
Mounting Clips, Hammer-Lock	148, 170
N	
Neoprene Tubes	179
NH3 Knife	177
Noble Sweeps	171
Notched Edge Disc Blades	152, 153
P	
Peanut Blades	171
Planter Gauge Wheel Bearings	162
Planter Gauge Wheel Tires	162
Planter Gauge Wheels	162
Plow Bolts	146
Plow Coulters	151
Plow Landsides	148
Plow Moldboards	147
Plow Parts, Moldboard	147
Plow Shares	148 - 149
Plow Shins	147
Plow Wear Pads	148
Points, Chisel	173 - 174
Points, Ripper	175
Points, Slash	174
Points, Spring Tooth	173
Points, Subsoiler	175
Points, Wing Sweep	171
Poly Shank Savers	174
Press Wheel Tires	162
Protective Coating Spray	146
R	
Ripper Caps	175
Ripper Points	175
Rippled Coulters	151
Row Crop Sweeps	169
S	
S-Tine Clamps	172
S-Tines	172
Seed Disc Openers	178 - 179
Seed Openers	178 - 179
Seed Tubes	179
Shank Savers	174
Shares, Plow	148 - 150
Shares, Ribbed	148 - 150
Shares, Upset Forged	150
Shares, Wing	173
Shins	147
Single Disc Openers	178
Slash Points	174
Smooth Edge Disc Blades	152, 153
Special Concavity Disc Blades	153
Special Plow Bolts	146
Spikes, Alfalfa	173
Spikes, Swedged	?

S continued	
Spoons, Air Seeder	170
Spring Tooth Points	173
Spring Tooth Sweeps	173
Steels, Cultivator	169
Stem Angles	142 - 143
Subsoiler Caps	175
Subsoiler Coulters	151
Subsoiler Points	175
Swedged Spikes	?
Sweep Application Charts	141
Sweep Terminology	139
Sweeps, Chisel	172, 173
Sweeps, Chisel Plow	172, 173
Sweeps, Danish	172
Sweeps, Field Cultivator	169
Sweeps, Hammer-Lock	170
Sweeps, Joyce	171
Sweeps, Knock-On	170
Sweeps, Noble	171
Sweeps, Row Crop	169
Sweeps, Spring Tooth	173
Sweeps, Terminator	170
Sweeps, Wheatland	171, 173
Sweeps, Wing	171
T	
Talc Powder	168
Technical Information	127 - 145
Terminator Sweeps	170
Terminology, Disc Blades	139
Terminology, Moldboard Plow	127 - 138
Tines, Danish	172
Tires, Gauge Wheel	162
Tubes, Fertilizer	179
Tubes, Neoprene	179
Tubes, Seed	179
V	
V-Sweeps	171
W	
Warranty Policy, Disc Blade	139
Wavy Coulters	151
Wear Pads	148
Wheatland Sweeps	172, 173
Wheels, Gauge	162
Wing Shares	173
Wing Sweep Points	173
Wing Sweeps	171

Moldboard Plow Information

Moldboard Plow

The primary purpose of the moldboard plow is to completely turn the soil to a depth of from 8 to 14 inches. This places the residue which was on top of the soil either under the soil or mixed with the soil.

There are two basic types of moldboard plows:

- 1) One way moldboard plow — the original and still most popular plow. Soil is always turned to the right hand side.
- 2) Two way or rollover plow — has two sets of bottoms; $\frac{1}{2}$ being right hand and the other $\frac{1}{2}$ being left hand.

All moldboard plows have three parts in common. The frame, the beam, and the frog. The beam attaches to the frame of the plow and the frog attaches to the beam. The frog and its attached components, the share, shin, landside and moldboard, is the part that engages the soil.

Moldboard Plow Terms

Deep Suck — Penetration point of the plow share that enables the share to "pull" itself into the soil.

Flat-Blade Type Share — Has no deep suck penetration point.

Full Cut Share — Cutting edge extends outwards at both ends of plow share to cut full width that share was designed for.

Narrow Cut Share — Back, or rear cutting edge of plow share cut off "shorter" to cut less than full cut plow was designed for.

Shin — A replaceable extension for the front of the moldboard where the most wear is encountered.

Landside — Heavy steel or cast iron plate bolted to the frog assembly to counteract the natural tendency of the plow to constantly run into the land.

Wear Pad — A piece of steel bolted to the landside wear face that can be reversed and then replaced at less cost than the entire landside assembly.

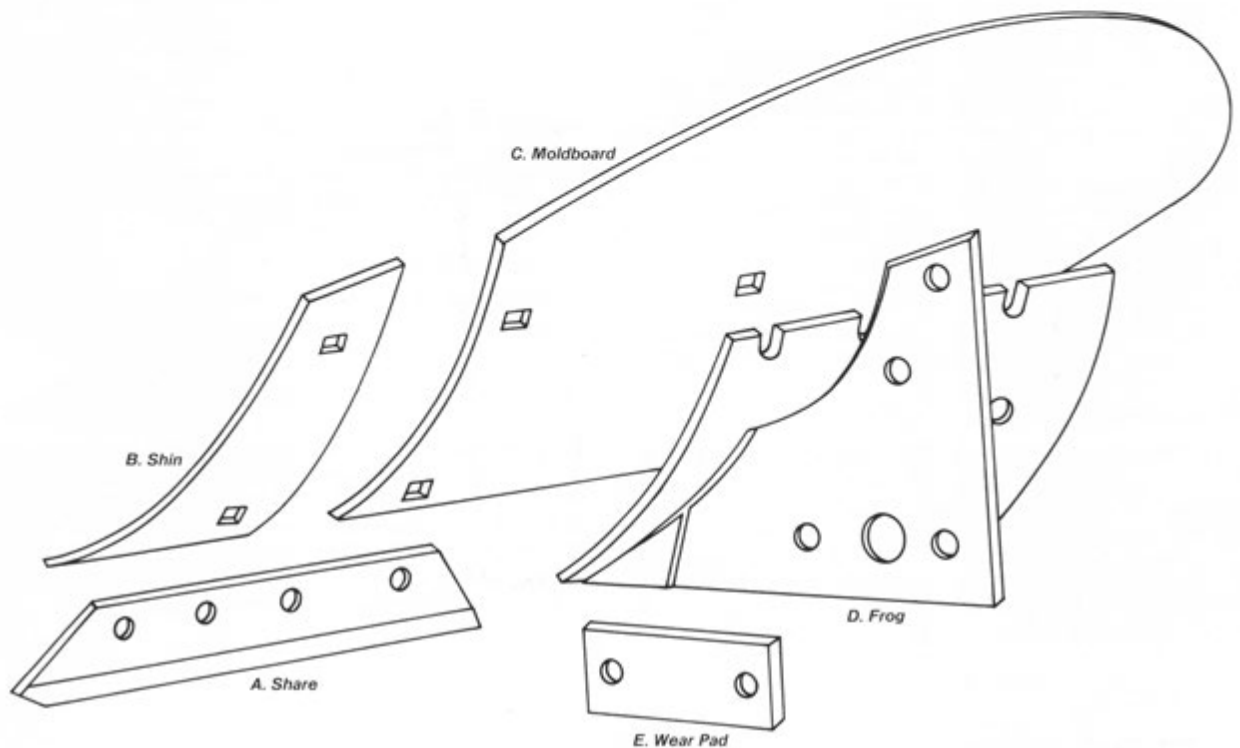

Landside Information

107980 Landside — FORD — Front Landside
 107980 R.H. Shown
 108427 L.H. Opposite
 General Purpose Bottom

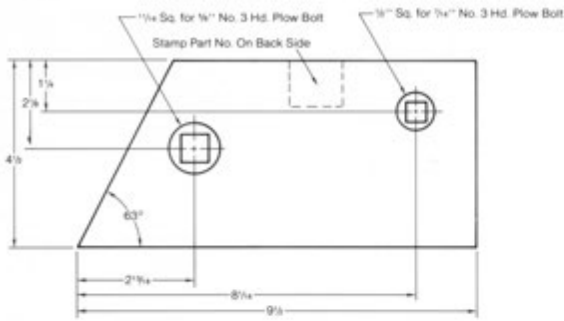

T10856 Landside — CASE PLOWS — Front or Rear
 Landside for EX Series Bottoms

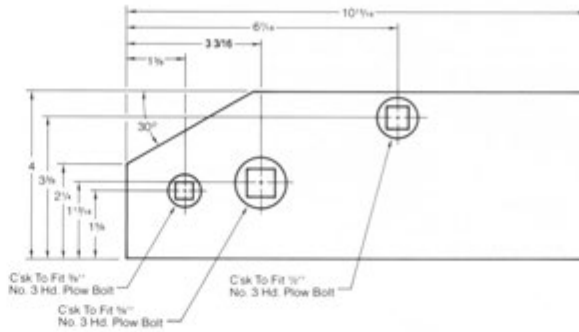

107981 Landside — FORD — Rear Landside
 107981 R.H. Shown
 108429 L.H. Opposite
 General Purpose Bottom

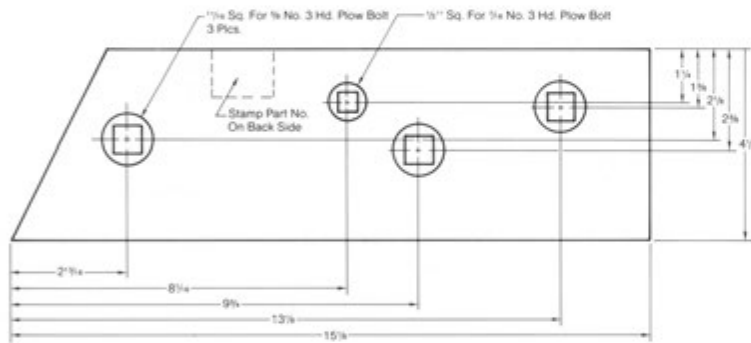

522342 Landside — IHC — "Front" Landside
 Right Hand Shown
 Left Hand Opposite
 Super Chief Bottom

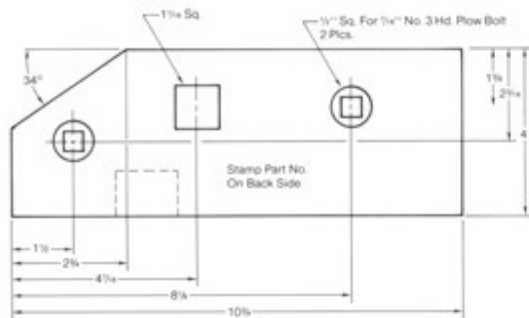

522343 Landside — IHC — "Rear" Landside
 Right Hand Shown
 Left Hand Opposite
 Super Chief Bottom

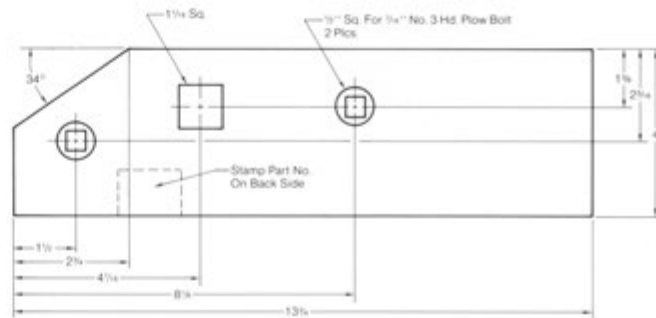

Landside Information

A16493 Landside — JOHN DEERE
 Front or Rear Landside for all "HS" or "NU" Series
 Plow Bottoms. Use with AA 15262 Wear Pad.

A16493 R.H. Shown
 A16494 L.H. Opposite

AA15262 Wear Pad/Heel - JOHN DEERE HS & NU

AA15262 R.H. Shown
 AA15263 L.H. Opposite

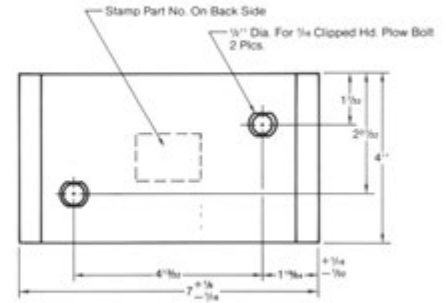
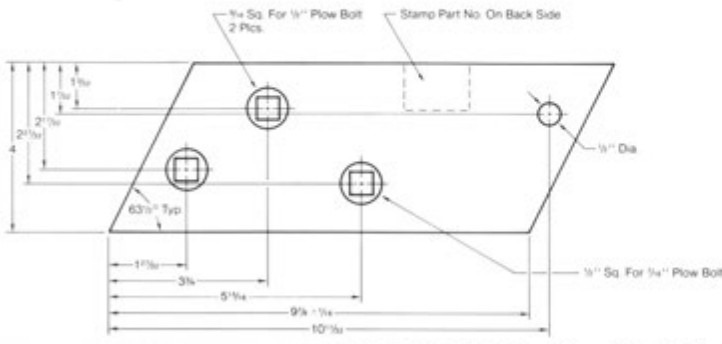

660003 Landside — MASSEY-FERGUSON — "Rear" Landside for "N" — "N-Heavy Duty" Bottom

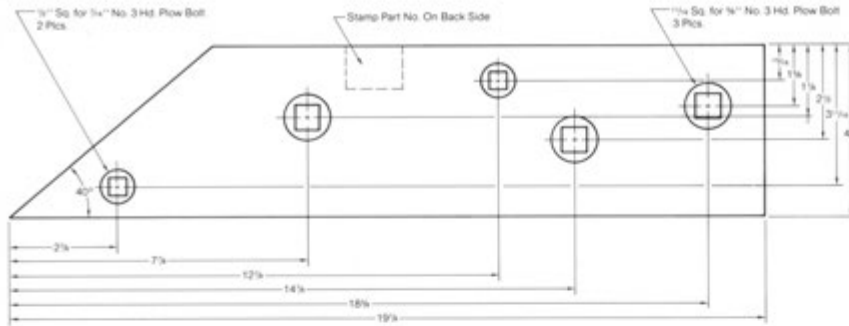

495937 Landside — MASSEY-FERGUSON — Front or Rear Landside for "N" Heavy Duty & High Speed use in conjunction with Deere AA 15262 wear pad.

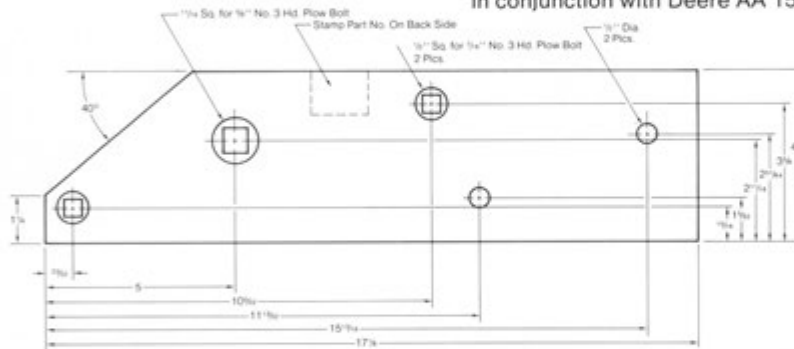

660002 Landside — MASSEY FERGUSON — Front Landside for "N" and "N-Heavy Duty" Bottom.

660002 R.H. Shown
 661580 L.H. Opposite

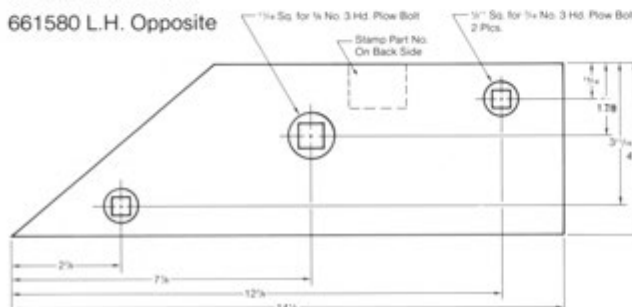

Landside Information

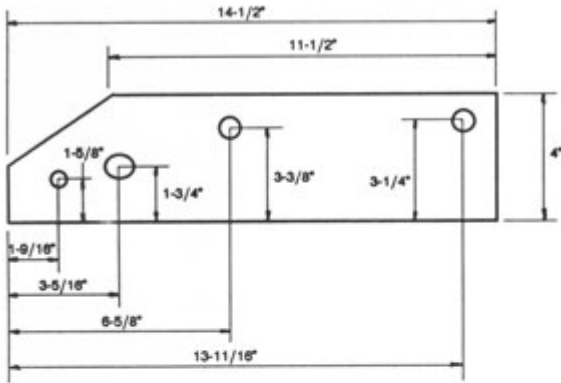

T51968 OFFSET LANDSIDE
3/8 X 1-1/2-5/8 X 2-1/2 - 1/2 X 2-1/4-7/16 X 1-1/2

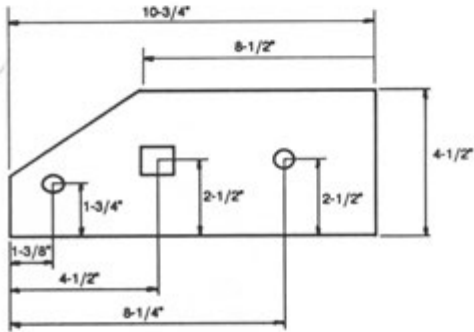

489465 RH LANDSIDE
542417 LH LANDSIDE
7/16 X 1-3/4 - 7/16 X 1-3/4

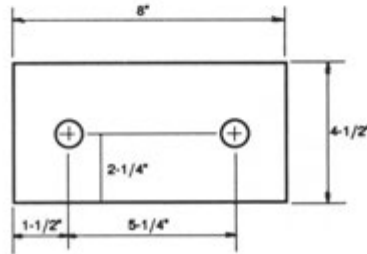

A27862 LANDSIDE
5/8 X 3-1/2-5/8 X 3-1/2

Plowshare Information

ALLIS CHALMERS

AM16-4RS

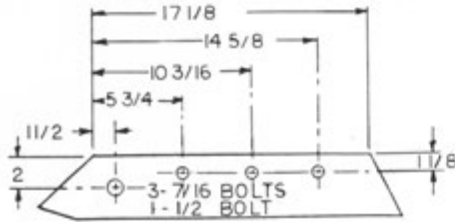

AM18-4RS

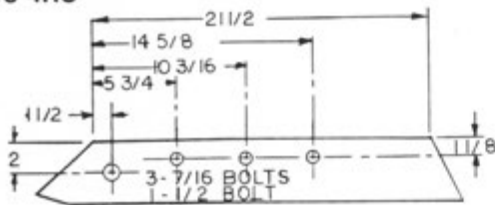

FORD

FF14-3RS

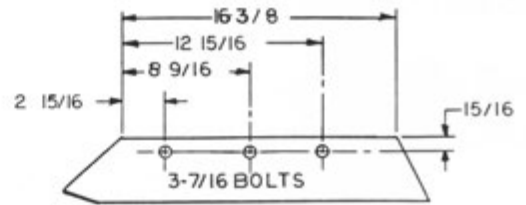

FF16-3RS

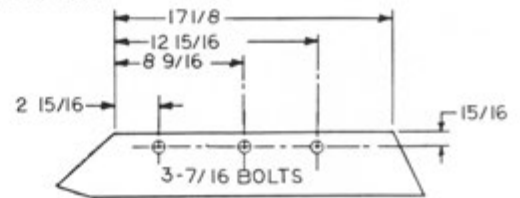

FF14-4RS

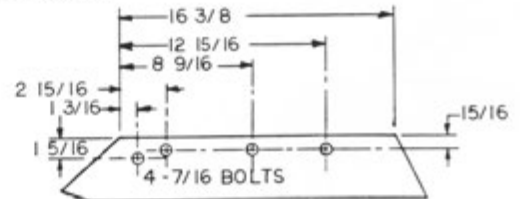

FF16-4RS
FF16-4LRS

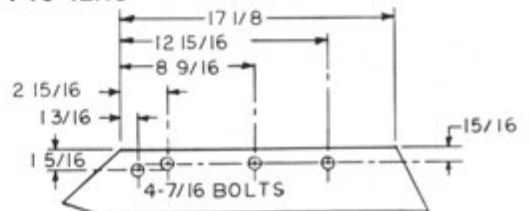

FF18-5RS

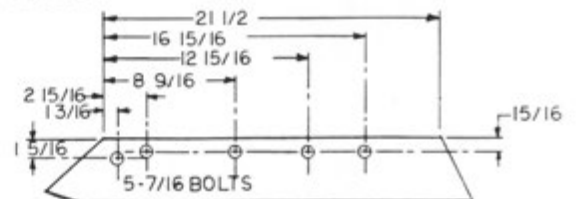

Plowshare Information

IHC

MI14-3RS

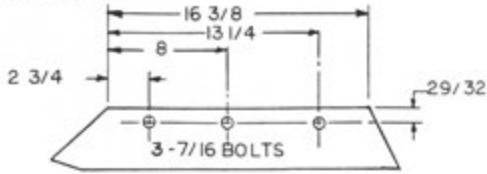

MI16-3RS

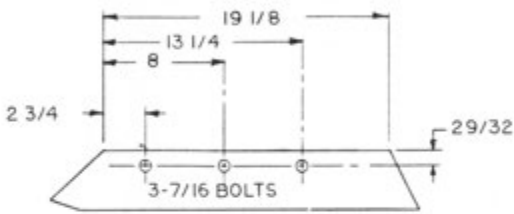

IH14-4RS

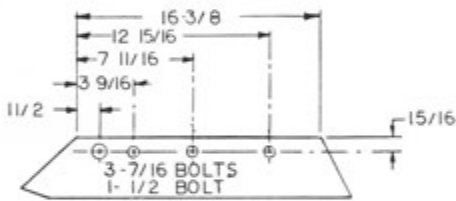

IH16-4RS
IH16-4LRS

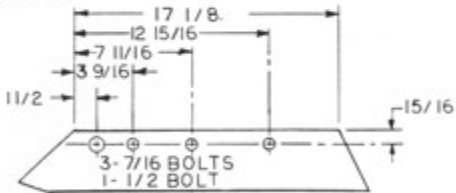

IH18-4RS
IH18-4LRS

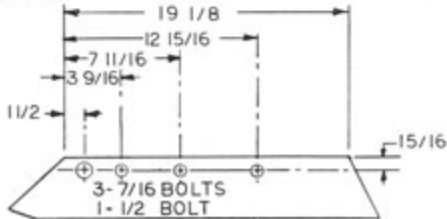

J. I. CASE

CA16-3RS

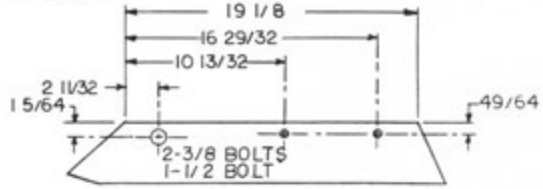

CA16-4RS
CA16-4LRS

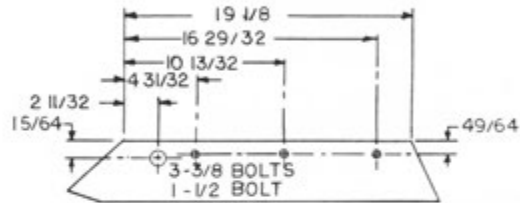

JOHN DEERE

JD14-3RS

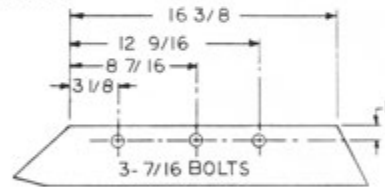

JD16-3RS

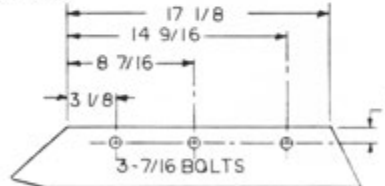

JD14-4RS

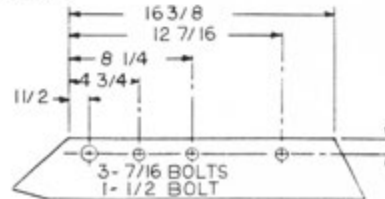

Plowshare Information

JOHN DEERE

**JD16-4RS
JD16-4LRS**

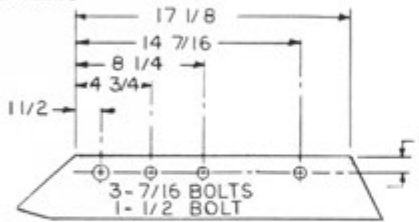

**JD18-5RS
JD18-5LRS**

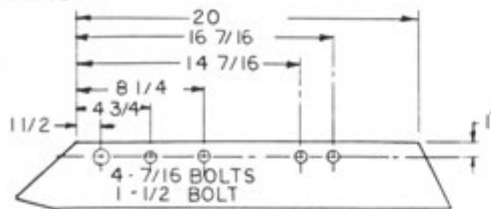

JD18-3RS

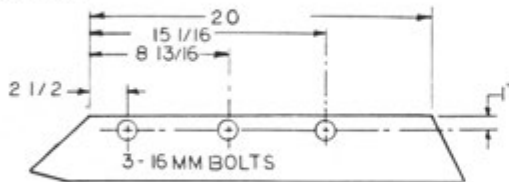

MASSEY FERGUSON

MI14-3RS

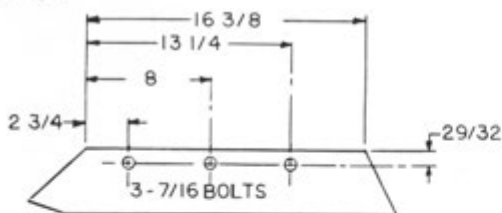

MI16-3RS

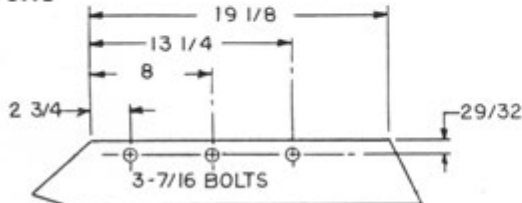

MF14-4RS

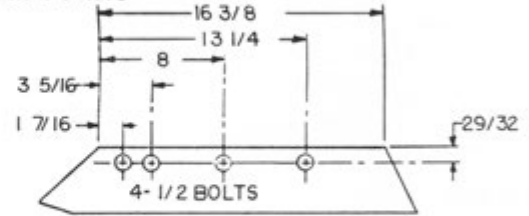

**MF16-4RS
MF16-4LRS**

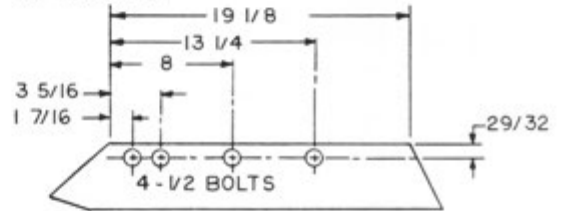

**MF18-4RS
MF18-4LRS**

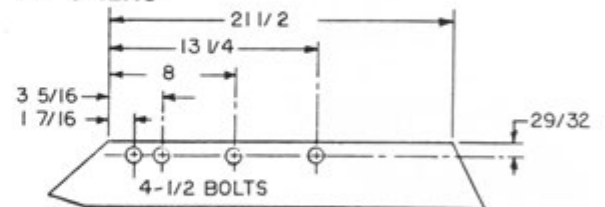

MELROE

MM14-4RS

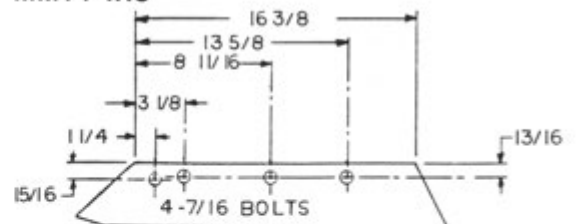

MM16-4RS

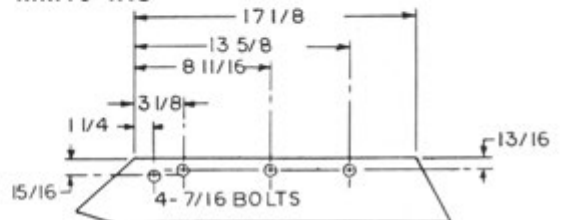

Plowshare Information

MM18-4RS

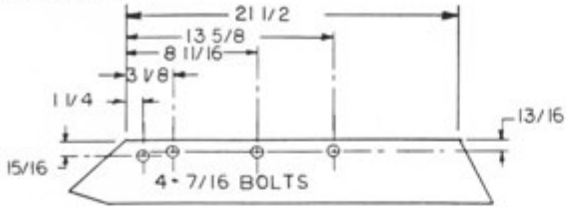

MR16-4RS

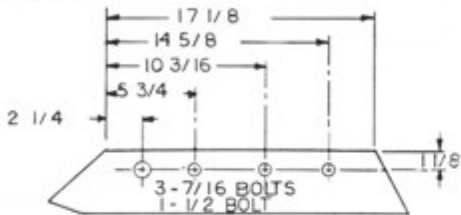

MR18-4RS

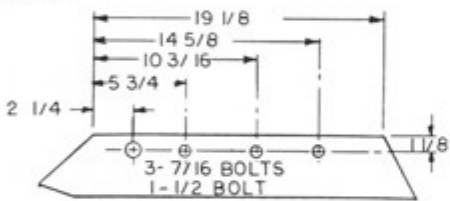

OLIVER-WHITE-M&M

OM14-4RS

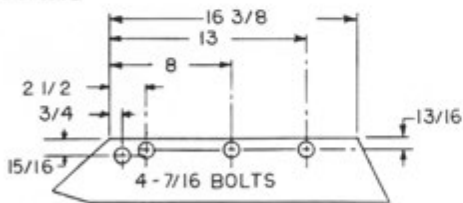

**OM16-4RS
OM16-4LRS**

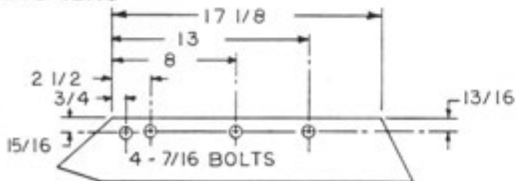

**OM18-5RS
OM18-5LRS**

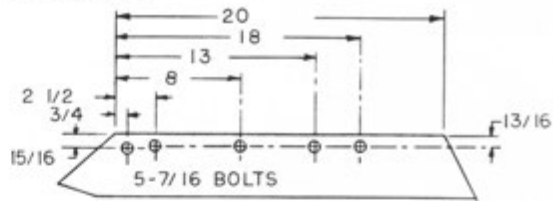

**OC16-4RS
OC16-4LRS**

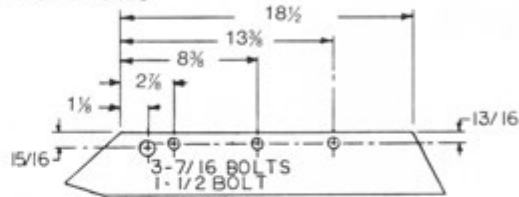

**OC18-5RS
OC18-5LRS**

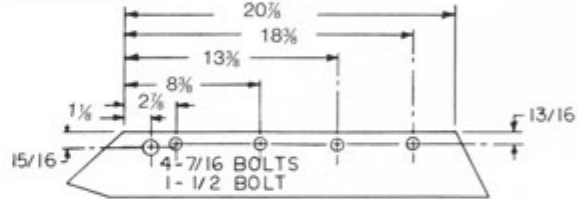

OC20-5RS

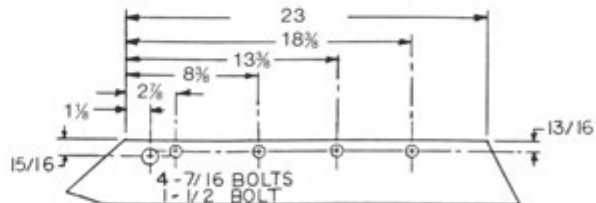

OD18-5RS

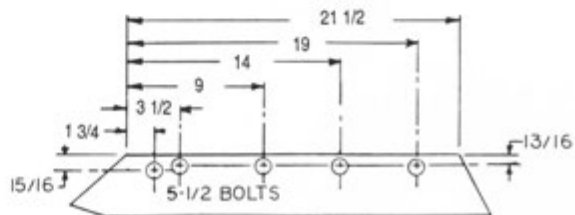

Plowshare Information

WATTS

WA18-4RS

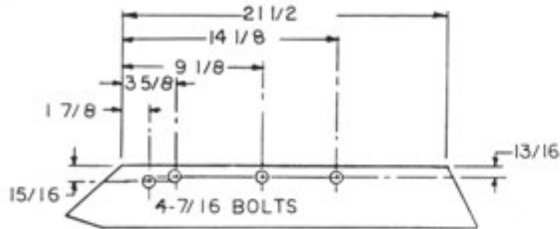

WIL-RICH

WR18-4RS

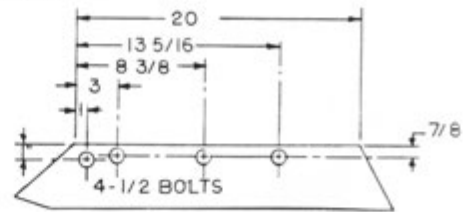

BAKER

BA25-6RS

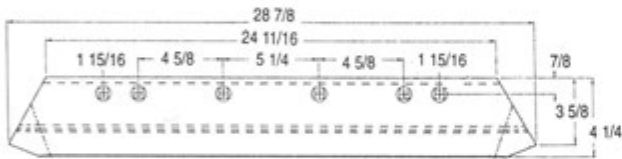

HARRELL

HA24-5RS

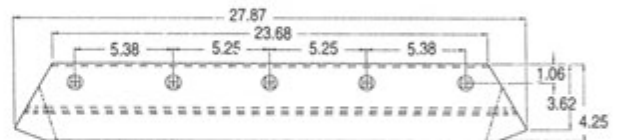

JOHN DEERE

JD24-4RS

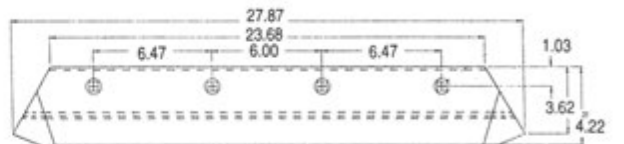

Moldboard Information

ALLIS CHALMERS

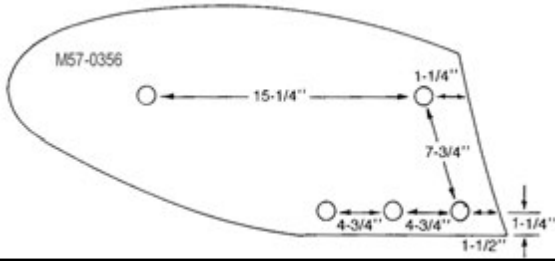

JOHN DEERE

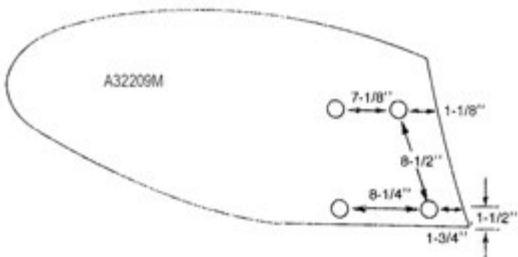
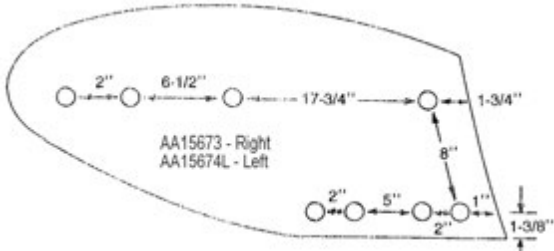
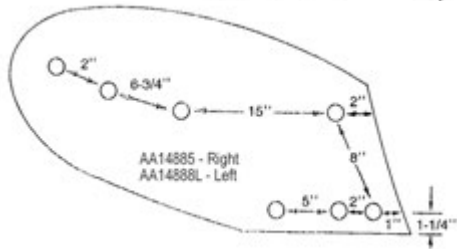
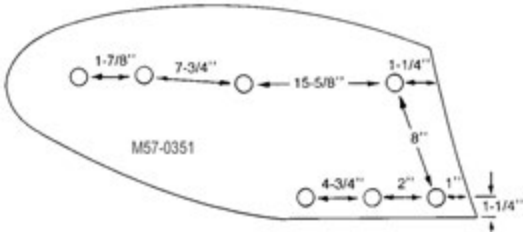
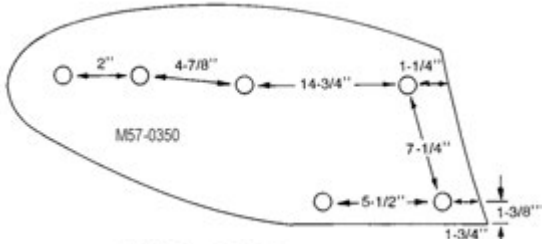

FORD

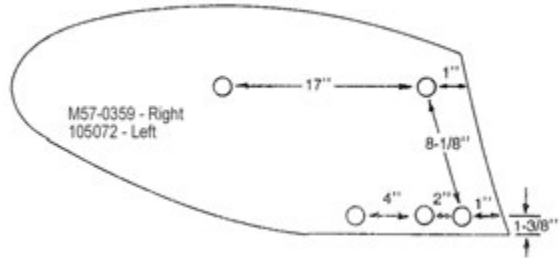
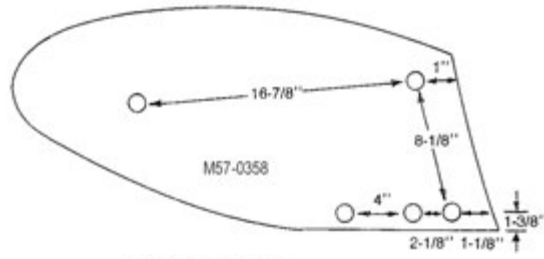

IHC

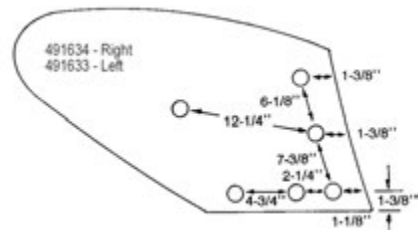
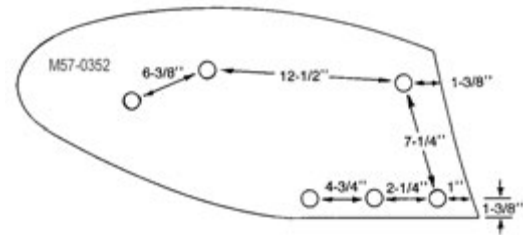

MASSEY FERGUSON

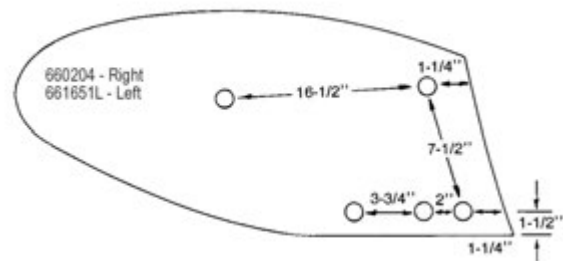

Moldboard and Shin Information

OLIVER/WHITE

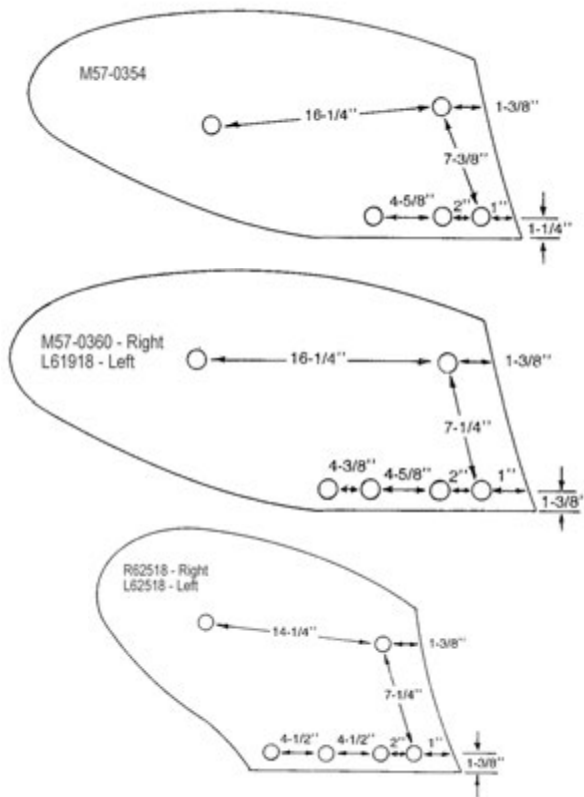

JOHN DEERE

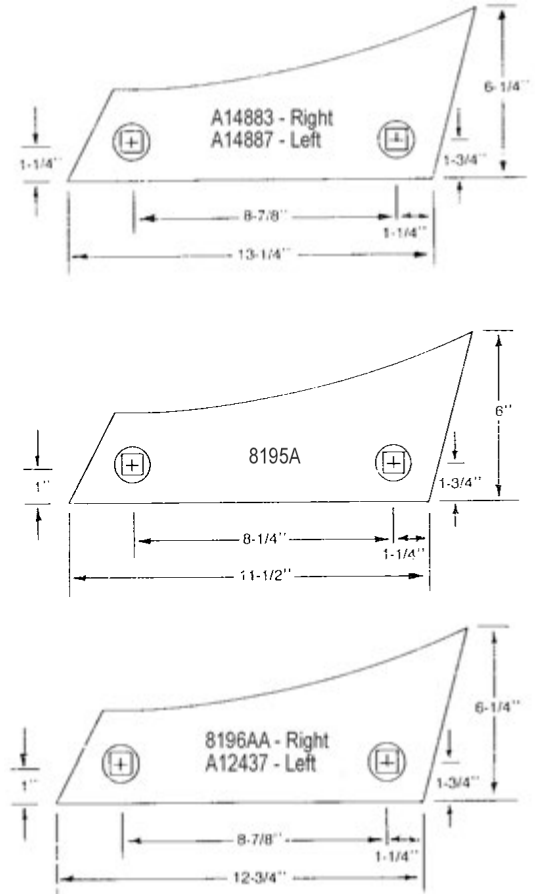

SHINS

ALLIS CHALMERS

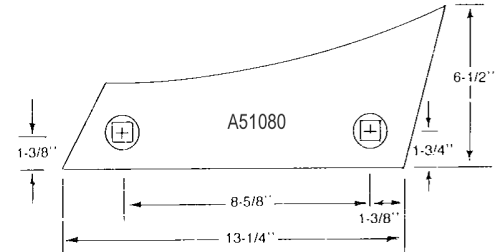
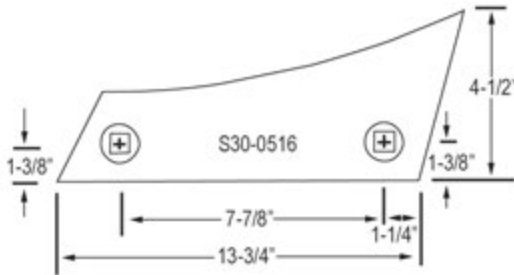

CASE

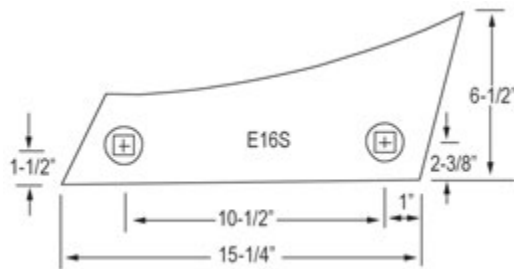

FORD

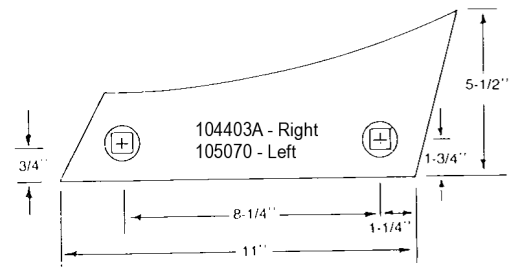

Shin Information

IHC

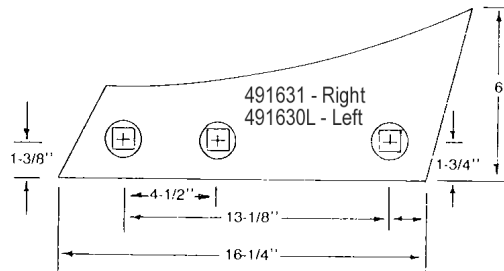
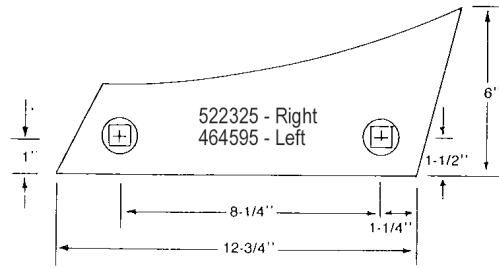

MASSEY FERGUSON

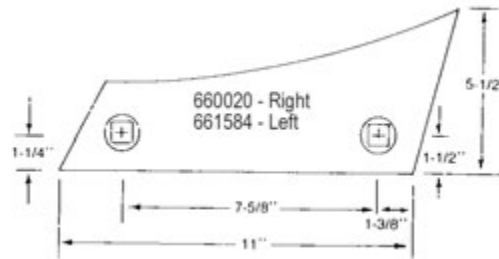

OLIVER/WHITE

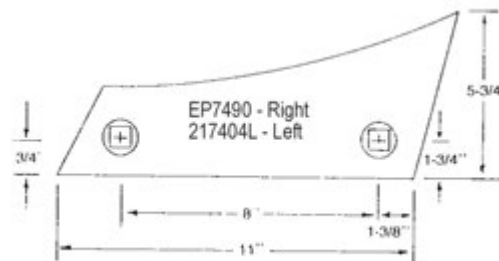
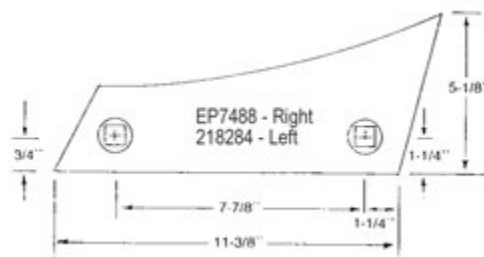

SWEEP TERMINOLOGY

- A. **Point Suck** - Concentrated soil penetration point of the sweep. Manufactured on a lower horizontal plane than the wings to provide increased soil penetration.
- B. **Bevel** - Edges of wings are forged in a press so the sweep self-sharpens with field use.
- C. **Stem Angle** - Refers to the angle the sweep shank forms with the horizontal plane of the ground. Determines the depth of soil penetration.
- D. **Size** - Refers to the distance between the two outside edges of the wings of a sweep.
- E. **Crown** - The distance from the ground to the tip of the wing and lower bolt hole measured on a level plane. These measurements determine the volume of dirt that the sweep will go through. We offer low and medium crown sweeps.

DISC BLADE TERMINOLOGY

Normal Concave

Recommended in light soils and in rocky fields to control soil movement. In rocky conditions, they reduce stress loads on the frame and gang components. In other soil types, especially with 7 1/4 to 9 inch blade spacing, concave blades also may be your choice for general purpose disking and chemical incorporation.

John Deere Design Conical

Recommended for medium and heavy soils for more aggressive cutting and mixing action. May also penetrate better than spherical blades.

Case - IH Design Flat Back

Offered as replacement for O.E.M. blade. Same cutting and soil movement action as a normal concave disc.

Miller (New Holland) Design Special

Offered as replacement for O.E.M. blade. These blades feature a special shallow concavity.

Plain Disc

Recommended for most tillage applications.

Notched Disc

Improves penetration in hard ground and slicing action in heavy residue.

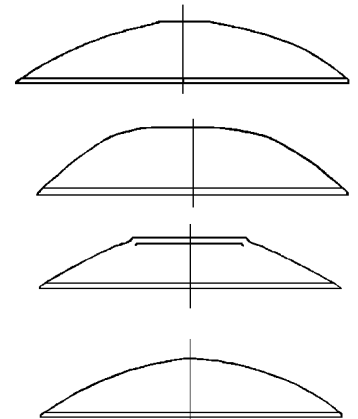

Plain

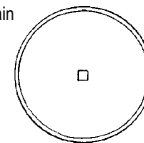

Notched

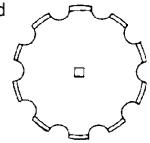

DISC BLADE WARRANTY POLICY

Note: Disc Blades carry 100% warranty on edge breakage or bending up to 1" in diameter wear.



Full Credit

Straight directional break due to defective material.



Full Credit

Laminated or split, caused by defective material.



No Credit

Irregular breaks or disc blade fracture resulting from overloading in rock or stump conditions or other solid objects.



No Credit

Irregular breaks or disc blade fracture resulting from overloading in rock or stump conditions or other solid objects.



No Credit

Center broken out caused by either implement design fault, excessive draft, excessive flexing of disc or loose gang bolts in rock or stump conditions.

Disc Blade Application Chart

Disc Model No. Axle Size

Allis Chalmers	
2100-2300	1 1/2 Square
3400	1 1/2 Round

Amco	
WOD, WTD	1 1/8 Square
WOE	1 3/8 Round
WOR, WOJ	1 1/2 Square
WTF, WTJ	1 1/2 Square

48, 85, 148, 185, 248, 258	
F15B & F15	1 1/2 Square

Athens	
48	1 Square
62	1 1/8 Square
126	1 1/2 Square
131	1 1/2 Square

Binkley	
700 Series	1 1/2 Round

Blanton	
4500	1 1/2 Square
B900	1 1/8 Square
B1000	1 1/8 Square
3000H	1 1/2 Square

Burch	
Kwik-Set	1 1/8 Square
209	1 1/8 Square
208 BW	1 1/2 Round
Tru-Cut	7/8 Square

Bush-Hog	
245	1 1/4 or 1 1/2 Square
1440	1 1/8 Square
1445	1 1/8 or 1 1/4 Square
1450	1 1/8 or 1 1/4 Square
145	1 1/4 Square
146 Reg	1 1/4 Square
146 HD	1 1/2 Square
1422	1 or 1 1/8 Square
1424	1 1/8 Square
1432	1 1/8 Square
1436	1 1/8 Square
1437	1 1/8 or 1 1/2 Square
1438 & 1439	1 1/8 Square
1444	1 1/8 Square
Rolling Bedder	1 1/8 Square

Dunham Lehr	
GC	1 1/8 Square

Ford	
201	1 Round
202	1 Round
204	1 Round
219	1 1/2 Square
220	1 1/8 Square
221	15/16 Round
222	1 1/8 Square
236	1 1/2 Square
243	1 1/2 Round

Hesston	
2410	1 3/4 Round

Disc Model No. Axle Size

International Harvester	
122, 132, 350, 370	1 1/8 Square
400, 470	1 1/8 Square
490	1 1/8 Square
500	1 1/2 Square
610	1 1/2 Square
630	1 1/2 Round

John Deere	
105	1 Round
115	1 1/8 Round
225	1 1/2 Round
425	1 1/2 Round
1630	1 1/2 Square
100	1 1/8 Square
110	1 1/8 Square
200 & 210	1 1/8 Square
215	1 1/2 Round
220	1 1/8 Square
225	1 1/2 Round
230 (Cone Disc)	1 1/8 Square
235	1 1/8 & 1 1/2 Round
310	1 1/4 Square
425	1 1/2 Round
525	1 1/2 Round
1630 & 1635	1 1/2 Square
1640	1 1/2 Square
2620 (Cone Disc)	1 1/2 Square
2621	1 1/2 Square
2650	1 3/4 Square
2651	1 3/4 Square
2700	2 1/4 Square
BWA	1 1/4 Square
BWF	1 1/4 Square

Kewanee	
800	1 1/8 Square
1000	1 1/8 Square

Krause	
1952-1956-60-70	1 1/2 Round
1959-63-73	
1968-1969-1979	1 1/2 Round
1965-1966-1976	1 1/2 Round
2100 Series	1 1/2 Round
2200 Series	1 1/2 Round
2400 Series	1 1/2 Round
2400 Series	1 3/4 Round
3100 Series	1 1/2 Round
3200 Series	1 3/4 Round
1498 & 1499	1 1/2 Round
1465-1470	1 3/4 Round
1580-1480	1 1/2 Round
1710-1769	1 3/7 Round
1912-1915-1918	1 1/2 Round
1901-1904-1907	1 1/2 Round
1922-1925-1928	1 1/2 Round
1921-1924-1927	1 1/2 Round
1959-1963-1973	1 1/2 Round

Long	
953	7/8 Square
1080	1 1/2 Square
1087, 88, 89	1 1/2 Square

Disc Model No. Axle Size

Massey Ferguson	
MF520, 620, 820	1 1/4 Square
MF21	1 Square
MF30, 720	1 1/2 Square
MF25, 39	1 Round
MF40	1 1/2 Square
MF52	1 1/8 Square
MF72	1 1/8 Round

Miller	
Series I	1 3/4 Round
Series II	1 3/4 Round

New Holland	
OD100	1 3/4 Round
OD200	1 3/4 Round
OD300	2 Round
TD100	1 3/4 Round
TD200	1 3/4 Round

Rhino	
177	1 1/2 Square
Flex 90	1 1/8 Square
Flex 90B	1 1/4 Square

Sunflower	
1210	1 1/2 Round
1211	1 3/4 Round
1230	1 1/2 Round
1231	1 3/4 Round
1320 & 1330	1 3/4 Round
1321 & 1331	1 3/4 Round
1430 & 1440	1 3/4 Round
H-3 & H-4	1 3/4 Round
1431-1441	1 3/4 Round
1541	

Schafer	
355	1 3/4 Round
555	2 Round

Taylor Way	
200251 thru 200268	1 1/2 Square
200108 thru 200118	1 1/8 Square
20023	1 1/8 Square
20024	1 1/8 Square
200196-200199	1 1/8 Square
2000051-2000068	1 1/8 Square
200284-200291	1 1/2 Square
200310-200315	1 1/2 Square
2001 Series	1 1/8 Square
200011	7/8 Square
200013	7/8 Square
200035	1 1/8 Square
200036	1 1/8 Square
200037	1 1/8 Square
200048	1 1/8 Square
200049	1 1/8 Square
2000165	7/8 Square
2000166	7/8 Square
2000167	7/8 Square

Vasser	
Disc-Ezy	1 1/8 Square

White	
251	1 1/8 Square
252	1 1/8 Square
253	1 1/8 Square
263	1 1/8 Square
265	1 1/8 Square
271,272	1 1/8 Square
281	1 1/2 Square

Application Charts

CHISEL PLOW (WHEATLAND) SWEEPS

Application	Bolt Size *	Hole Spacing	Stem Angle
Allis Chalmers 22" - 32" (now Deutz-Allis)	7/16" R	2 1/4" - 2 1/2"	43°
Anderson	7/16" R	2 1/4" - 2 1/2"	50°
Brady	7/16" R	2 1/4" - 2 1/2"	50°
Case (Later Models)	7/16" R	2 1/4" - 2 1/2"	50°
Case-IH	7/16"	2 1/4" - 2 1/2"	43°
C.C.I.L. 1" Thick Shank	7/16" R	2 1/4" - 2 1/2"	50°
C.C.I.L. 1 1/4" Thick Shank	1/2"	2 1/4" - 2 1/2"	43°
Cockshutt 240, 246, 247, 476, 249	7/16" R	2 1/4" - 2 1/2"	50°
Crown	1/2"	2 1/4" - 2 1/2"	50°
DMI	1/2"	2 1/4" - 2 1/2"	50°
Dengelmen	7/16" R	2 1/4" - 2 1/2"	50°
Edwards	7/16" R	2 1/4" - 2 1/2"	50°
Flexi-Coil (2" x 1" Shank)	1/2"	2 1/4" - 2 1/2"	50°
Ford 131	7/16" R	2 1/4" - 2 1/2"	50°
Friggstad	7/16" R	2 1/4" - 2 1/2"	50°
Glencoe (High Clearance)	7/16" R	2 1/4" - 2 1/2"	50°
Graham (High Clearance)	7/16" R	2 1/4" - 2 1/2"	50°
Hiniker	1/2"	2 1/4" - 2 1/2"	50°
IHC 10, 50, 55, 75, 64 S	7/16" R	2 1/4" - 2 1/2"	43°
Ingham	1/2"	2 1/4" - 2 1/2"	43°
Jeoffery 16"	7/16" R	2 1/4" - 2 1/2"	50°
Jeoffery 22" - 32"	7/16" R	2 1/4" - 2 1/2"	43°
John Deere	7/16" R	2 1/4" - 2 1/2"	50°
Kewanee	7/16" R	2 1/4" - 2 1/2"	50°
Killbery	7/16" R	2 1/4" - 2 1/2"	50°
Krause (High Clearance)	7/16" R	2 1/4" - 2 1/2"	50°
Leon	1/2"	2 1/4" - 2 1/2"	50°
Massey Harris	7/16" R	2 1/4" - 2 1/2"	43°
Massey "Trash King"	7/16" R	2 1/4" - 2 1/2"	50°
Mel-Cam	7/16" R	2 1/4" - 2 1/2"	50°
Mel-Cam Cultivator	7/16" R	2 1/4" - 2 1/2"	43°
Minneapolis Moline T600, 1500, 1800	7/16" R	2 1/4" - 2 1/2"	50°
Minn-Toba 120, 176	7/16" R	2 1/4" - 2 1/2"	50°
Minn-Toba 3 Point Hitch	7/16" R	2 1/4" - 2 1/2"	43°
Mohawk	1/2" R	2 1/4" - 2 1/2"	43°
Morris 220	7/16" R	2 1/4" - 2 1/2"	43°
Morris MP 912 & Magnum	1/2"	2 1/4" - 2 1/2"	50°
Noble XR-20	7/16" R	2 1/4" - 2 1/2"	50°
Oliver	7/16" R	2 1/4" - 2 1/2"	43°
Robin/Nodwell	7/16" R	2 1/4" - 2 1/2"	50°
Rogin	7/16" R	2 1/4" - 2 1/2"	50°
Roll-O-Cone	1/2"	2 1/4" - 2 1/2"	50°
Roll-O-Flex	7/16" R	2 1/4" - 2 1/2"	50°
Schulte 300	1/2"	2 1/4" - 2 1/2"	50°
Sunflower	7/16" R	2 1/4" - 2 1/2"	50°
Versatile	7/16" R	2 1/4" - 2 1/2"	50°
Victory	7/16" R	2 1/4" - 2 1/2"	50°
Wil Rich	1/2"	2 1/4" - 2 1/2"	43°

* (R) In some instances our inventory reducer bolt (7/16" bolt w/1/2" head) is required.

FIELD CULTIVATOR SWEEPS

Application	Bolt Size	Hole Spacing	Stem Angle
Allis Chalmers (now Deutz-Allis)	(2) 7/16"	2"	54°
Allis Chalmers 1200, 1300	3/8"	N/A	N/A
Anderson	(2) 3/8"	1- 3/4"	47°
Baker	(2) 3/8"	1- 3/4"	41°
Becker/ATI	3/8"	N/A	N/A
Ber-Vac	3/8"	N/A	N/A
Bourgault	(2) 7/16"	1- 3/4"	47°
Brady (Prior to '70-'71)	(2) 3/8"	1- 3/4"	47°
Brady (After '70-'71)	7/16"	1- 3/4"	47°
Buckeye	3/8"	N/A	N/A
Bush Hog	(2) 3/8"	1- 3/4"	47°
Calkins	(2) 3/8"	1- 3/4"	47°
Case F.C., F.C.M., F.C.S.W.	(2) 3/8"	1- 3/4"	47°
C.C.I.L.	(2) 3/8"	1- 3/4"	47°
Cockshutt 285, 485	(2) 3/8"	1- 3/4"	47°
Crustbuster	(2) 7/16"	1- 3/4"	47°
Flexi-Coil 200, 400 Series	(2) 7/16"	1- 3/4"	47°
Ford 208	(2) 3/8"	1- 3/4"	47°
Frontier	(2) 7/16"	1- 3/4"	47°
Glencoe, F.C., M.F.C., F.C.S.W.	(2) 3/8"	1- 3/4"	47°
Note: Row Crop Cultivator Uses Same Sweep			
Glencoe Soil Finisher	3/8"	N/A	N/A
Hesston	(2) 7/16"	1- 3/4"	47°
Hiniker	(2) 7/16"	1- 3/4"	47°
IHC & Case IH	(2) 7/16"	1- 3/4"	47°
Deere 1000 Series	(2) 3/8"	1- 5/8"	41°
Deere CCA, C10, C20	3/8"	1- 3/4"	41°
Deere 960-FC	(2) 7/16"	1- 3/4"	47°
Kent	(2) 7/16"	1- 3/4"	47°
Kewanee	(2) 7/16"	1- 3/4"	47°
Koehn	3/8"	N/A	N/A
Kongsilde	3/8"	N/A	N/A
Krause 600/900	(2) 3/8"	1- 3/4"	47°
Landoll	(2) 7/16"	1- 3/4"	47°
Massey Ferguson 160	(2) 3/8"	1- 3/4"	47°
Minneapolis Moline FT200	(2) 3/8"	1- 3/4"	47°
Morris L240, L320	(2) 3/8"	1- 3/4"	47°
Noble Mix-N-Till	3/8"	N/A	N/A
Oliver 245, 345	(2) 3/8"	1- 3/4"	41°
Oliver 285, 385, 485	(2) 3/8"	1- 3/4"	47°
Rhino/Athens	(2) 7/16"	1- 3/4"	47°
Sunflower	7/16"	1-3/4"	47°
Taylor	(2) 3/8"	1- 3/4"	47°
Unverferth Culti-System	3/8"	N/A	N/A
Vicon/McKee	3/8"	N/A	N/A
Wil Rich	(2) 7/16"	1- 3/4"	47°
Win Power 1500	(2) 7/16"	1- 3/4"	47°
White Farm Equipment	(2) 3/8"	1- 3/4"	47°
Glencoe (old) 1250 "Double Shank"	(2) 3/8"	1- 3/4"	41°

STEM ANGLES - FIELD CULTIVATORS

MACHINE	STEM ANGLE				HOLE CENTERS			BOLT CENTERS		
	41°	43°	47°	52°	1-5/8"	1-3/4"	2"	3/8"	7/16"	1/2"
ALLIS CHALMERS				.			.			.
ALLIS CHALMERS				54"						.
ALLIS CHALMERS (early models)	.							.		
ANDERSON			.			.		.		
BAKER	.							.		
BOURGAULT 6200, 6800, 8800, 8810, 5710 Air Drill			.			.				.
BRADY (before 70-71)	.					.		.		
BRADY (after 70-71)			.					.		
BRADY 3400			.						.	
BRADY		.						.		
BRILLION (prior 1986)	.							.		
BRILLION (after 1986)			.						.	
BUFFALO (no till)				54"					.	
BUSH HOG			.			.		.		
BUSH HOG			.						.	
CALKINS			.					.		
CASE FC, FCW, FCM			.			.		.		
CASE Minn-Toba				.			.		.	
CASE IH 45, 4300, 4500, 4600, 4700, 4800, 4900			.			.			.	
CCIL CI-200, 179, 279, 379			.			.		.		
COCKSHUTT (early models)	.							.		
COCKSHUTT 237, 239, 337			.			.			.	
COCKSHUTT 285, 485			.			.		.		
CRUSTBUSTER			.						.	
DAKON			.						.	
DEGELMAN 3000 series			.			.			.	
DMI TigerMate			.						.	
EZEE-ON			.			.				.
FARMERS FACTORY			.						.	
FLEXI-COIL 820, ST820, 5000, 7500 (350 lb.)			.			.				.
FLEXI-COIL 200, 400, 420, 800			.			.			.	
FORD 208			.			.		.		
FORREST CITY Do-All			.	54"				.		.
FRIGGSTAD			.						.	
GLENCOE Double Shank 1250	.							.		
GLENCOE PFC, MBC, PCMW			.			.		.		
GLENCOE FC, MFC, FCSW			.					.		
HESSTON			.			.			.	
HINIKER			.			.			.	
IHC 45, 46, 47			.			.			.	
INGHAM			.						.	
JEOFFROY 450			.			.		.		
JOHN DEERE OLD		.				.		.		
JOHN DEERE 1000, 1010, 1050, CCA, C10, C20	.							.		
JOHN DEERE 730, 940, 960, 1060			.			.			.	
KENT			.			.			.	
KEWANEE			.			.		.		
KRAUSE 600, 900, 5000, 6300, 6500, 7000			.			.		.		
KRAUSE K-Tine	.							.		
LANDOLL			.					.		
LEON VibraFlex			.			.		.		
M & W 724			.						.	
MASSEY FERGUSON 160			.					.		
MASSEY HARRIS			.						.	
MINN-TOBA LDC, 726, 729			.			.			.	
MINNEAPOLIS-MOLINE FT200			.			.		.		
MORRIS L240, L320, L249			.			.		.		

STEM ANGLES - FIELD CULTIVATORS

MACHINE	STEM ANGLE				HOLE CENTERS			BOLT CENTERS		
	41°	43°	47°	52°	1-5/8"	1-3/4"	2"	3/8"	7/16"	1/2"
MORRIS 9000, 9001, Challenger 2, Maxim 1 & 2			.			.		.		
MORRIS Concept 2000 (4000 lb. trip)			.			.				.
MULTIPLEX 245, 345			.					.		
NOBLE			.						.	
OLIVER	.					.		.		
OLIVER 285, 385, 485			.			.		.		
OLIVER 235, 245, 345		.						.		
RHINO (Athens)			.						.	
SUNFLOWER			.						.	
TAYLOR			.			.		.		
VALMAR			.			.			.	
VERSATILE 100		.				.			.	
VIBRASHANK			.			.			.	
WHITE			.				.		.	
WHITE			.			.		.		
WHITE 245, 345	.							.		
WIL-RICH			.			.			.	
WINPOWER 1500			.			.			.	

STEM ANGLES - CHISEL PLOWS

MACHINE	STEM ANGLE				HOLE CENTERS		BOLT CENTERS	
	43 ^o	47 ^o	50 ^o	54 ^o	2-1/4"	2-1/2"	7/16"	1/2"
ALLIS CHALMERS 22" & 32", 1400 Chiselvator	*				*		*	
ALLIS CHALMERS (other)			*		*		*	
ANDERSON			*		*		*	
BOURGAULT 9200, 9400, 9800			*		*			*
BRADY			*		*		*	
BRANDT				*	*		*	
BUSH HOG			*		*		*	
CALKINS 32" shank			*					
CASE older models		*			*		*	
CASE		*			*			*
CASE 10, 50, 55, 645, 4700, 4900, 5000	*				*			*
CASE WWC-37, 324			*					
CASE T25118W, T265663				*	*		*	
CASE CP700, 900, 110				*				
CASE IH Vibra Chisel	*				*	*		*
CASE IH 5800, 5850, 5900, PTX300, PTX600			*		*			*
CCIL 203, 204, 205 1 1/4" shank	*					*		*
CCIL high clearance 1" shank			*					
CCIL 806, 807, 808	*					*		*
CCIL Thick Shank - 806 (1 1/4" thickness)			*		*		*	*
COCKSHUTT 240, 246, 247, 249, 476			*		*		*	
CROWN			*		*		*	
DEGELMAN 500			*		*		*	
DEGELMAN 3000-2			*		*			*
DEMSTER							*	
DMI			*					
EDWARDS			*		*		*	
EZEE-ON			*		*			*
FARMHAND / GLENCOE		*						
FORD 131			*		*		*	
FORD 131				*	*		*	
FORD		*			*		*	
FORDSON MAJOR 513-1, 713-20			*		*		*	
FLEXI-COIL 300, 340, 600, 800CP			*		*			*
FLEXI-COIL 1" x 2" shank			*					
FLEXI-COIL 1 3/4" x 7/8" shank		*						
FRIGGSTAD older models			*		*		*	
FRIGGSTAD			*		*			*
GLENCOE		*			*		*	
GLENCOE		*			*			*
GLENCOE high clearance			*		*		*	
GLENCOE Giant 6				*	*		*	
GRAHAM Planet			*		*		*	
GRAHAM			*		*			*
GRAHAM 400, 500, 1600, 2600			*		*		*	
GYSLER		*			*		*	
HESSTON			*		*		*	
HESSTON			*		*			*
HINIKER			*					*
INGHAM	*				*		*	
IHC 10, 50, 55, 75, 509, 645	*				*	*		*
JEOFFROY 16"			*		*		*	
JEOFFROY 22", 32"	*				*		*	
JOHN DEERE 100, 150, 200, 250			*		*		*	
JOHN DEERE 1600			*		*		*	*
JOHN DEERE 610, 1650, 1810			*		*		*	*
JOHN DEERE 610 seeding tool			*		*			*
KENT	*				*			

STEM ANGLES CHISEL PLOWS

MACHINE	STEM ANGLE				HOLE CENTERS		BOLT CENTERS	
	43°	47°	50°	54°	2-1/4"	2-1/2"	7/16"	1/2"
KEWANEE			•					
KILBERRY			•		•		•	
KRAUSE low clearance		•			•		•	•
KRAUSE high clearance			•		•		•	•
KRAUSE				•	•		•	
LANDOLL			•					
LELY			•		•		•	
LEON			•		•		•	
MAJOR 513-1, 730-20				•				
MF	•				•		•	
MF 124, 125, 126, 128 trip				•	•		•	
MF Spring Cushion			•		•		•	
MF Trash King			•		•		•	
MASSEY HARRIS		•			•		•	•
MEL-CAM			•		•		•	
MEL-CAM Culti-Weeder	•				•		•	
MELROE (Clark)		•			•		•	•
MELROE (Clark)			•		•		•	
MINN-TOBA 3 PH	•				•		•	
MINN-TOBA 120, 176			•		•		•	
MM T600, T1500, T1800			•	•	•		•	
MM T500				•	•		•	
MOHAWK Trash King	•							
MOHAWK			•					
MORRIS 220, 4, 5, 6, 7 Series	•				•		•	
MORRIS 1982 Magnum 1	•				•			•
MORRIS Worn Trips		•			•		•	•
MORRIS Concept 2000 (755 lb. trip)			•		•			•
MORRIS Magnum II, 8900, 912, Case 8100			•		•			•
NOBLE XR20			•		•		•	
NOBLE 8000			•		•			•
OLIVER 247, 248, 347			•		•		•	
OLIVER 500 (Jeoffroy)	•				•		•	
RENN			•		•		•	
RITEWAY			•		•			•
ROBIN			•		•		•	
ROBIN				•	•		•	
ROBIN-NODWELL			•					
ROLL-O-FLEX			•		•		•	
ROGIN			•					
ROLL-O-TRIP			•					
ROLL-A-CONE			•					
SATURN			•					
SCHULTE			•					•
SUNFLOWER			•		•			
VERSATILE			•		•			
VICON			•		•			
VICTORY			•					•
WHITE 247, 249, 476			•		•		•	
WHITE 420, 435			•		•			•
WILCAR			•		•			
WIL-RICH early models	•				•		•	
WIL-RICH	•				•	•		•

#3 HEAD PLOW BOLT WITH NUT

- Right Hand, #3 • Grade 5



Size	Pkg. Qty.	Order No	List
3/8" x 1-1/4"	50	B55-0225	14.60
3/8" x 1-1/2"	50	B55-0230	18.37
3/8" x 2"	50	B55-0240	16.16
3/8" x 2-1/2"	50	B55-0245	25.93
7/16" x 1"	50	B55-0250	30.20
7/16" x 1-1/4"	50	B55-0255	22.78
7/16" x 1-1/2"	50	B55-0260	33.96
7/16" x 1-1/2"	10	B55-0260D	11.47
7/16" x 1-3/4"	50	B55-0265	28.02
7/16" x 1-3/4"	10	B55-0265D	11.47
7/16" x 2"	50	B55-0270	31.33
7/16" x 2-1/4"	50	B55-0274	37.55
7/16" x 2-1/2"	50	B55-0280	42.29
7/16" x 3"	50	B55-0285	43.64
1/2" x 1-1/2"	25	B55-0295	16.99
1/2" x 2"	25	B55-0300	47.15
1/2" x 2-1/2"	25	B55-0305	34.05
1/2" x 3"	25	B55-0310	63.80
5/8" x 2"	25	B55-0315	33.36
5/8" x 2-1/2"	25	B55-0320	31.50
5/8" x 3"	25	B55-0325	37.32

• Sold in package quantities only.

INDIVIDUAL BOLTS/NUTS

Size	Order No.	List
3/8" x 1-1/4"	A 527846	1.51
3/8" x 1-1/2"	A 484154	2.57
3/8" x 1-1/2" with 7/16" head	A 486449	1.29
3/8" x 2"	A 486498	0.77
7/16" x 1-1/4"	A 484089	1.07
7/16" x 1-1/2"	A 527853	1.29
7/16" x 1-3/4"	A 527812	1.36
7/16" x 2"	A 527796	1.95
7/16" x 3"	A 486225	1.49
1/2" x 2-1/2"	A 483719	2.34
1/2" x 3"	A 527838	1.33

SPECIAL PLOW BOLTS

- Right Hand
- Inventory Reducing
- Right hand, #3
- Grade 5
- Nuts Included



Used on Plowshares, Landsides and More!

Size	Pkg. Qty.	Order No	List
3/8" x 1-1/2" w/7/16" Head	50	716381550P	39.76
7/16" x 2-1/2" w/1/2" Head	50	127162550P	69.11

CLIPPED HEAD BOLTS - PLOWSHARES

- Right hand or left hand
- Grade 5
- Nuts included



Size	Pkg. Qty.	Order No	List
7/16" x 1-1/4", RH	50	7161450C	50.95
7/16" x 1-1/4" LH	50	B55-0560	169.65
7/16" x 1-1/2", RH	50	B55-0515	31.67
7/16" x 1-3/4", RH	50	B55-0520	43.03
1/2" x 1-1/4", RH	25	B55-0525	47.58
1/2" x 1-3/8" LH	25	B55-0565	44.38
1/2" x 1-1/2", RH	25	B55-0530	57.90
16 mm x 35 mm Metric, RH	50	M16350C	82.31

INDIVIDUAL CLIPPED HEAD BOLTS

Size With Nuts	Order No.	List
7/16" x 1-1/4"	A 527788	1.40
1/2" x 1-1/4"	A 483610	2.01

Front Bolt

For Rock Share	Order No.	List
3/8" x 1-1/2"	A 483677	0.93
7/16" x 1-1/2"	A 527843	1.57
1/2" x 1-1/2"	A 527861	2.71

PROTECTIVE PLOW COAT

A non-drying, low-gloss coating for use as temporary protection over tillage tools. Use on plow bottoms, disk blades, sweeps and shovels for protection against rust and corrosion. The soft coating will scour clean quickly when the implement is put into service. 12 oz. aerosol can.



Order No	List
A 972509	16.86

ELLIPTICAL HEAD BOLTS

- Right Hand H10
- Grade 5
- Nuts Included



Size	Pkg. Qty.	Order No	List
3/8" x 1-1/2"	50	381550E	21.95

MOUNTING CLIPS FOR SWEEPS

Install Clip Only Once When Using Quick Attach Style Sweeps.



Application	Bolt Size	Hole Spacing	Order No	List
Terminator Sweeps	7/16" Plow	1-3/4" to 2" Slotted. 47°	C45-0408	5.11
N Series Sweeps	7/16" Hex	1-3/4" 47 degree	C45-0607	4.60
N Series Sweeps	7/16" Hex	2" 47 degree	C45-0608	4.60
N Series Sweeps		Safety Spring	C45-0610	2.60

HEAVY DUTY MOUNTING CLIP FOR SWEEPS

Install Clip Only Once When Using Quick Attach Style Sweeps.



Application	Bolt Size	Hole Spacing	Order No	List
N Series Sweeps	1-5/8"	2" 47 degree	C45-0615	4.05

MOLDBOARDS

Made In The USA



- Heat-Treated
- Sold Individually
- Painted Black Finish
- 1080 High Carbon Steel
- Solid Construction, 5/16" thick
- Moldboards Require:
(5) Grade 5 #3 Plow Bolts
7/16" Dia. x 1" or 1-1/2 Long

Manufacturer	Models	Size	Mfg. No.	Order No.	List
DMI	Hydrawide	16", 18"	33111601	M57-0353	262.16
Ford	General Purpose	14"	104409	M57-0358	194.02
Ford	General Purpose	18"	R619-18HB	M57-0360	293.07
Harrell	Switch Plow	24"	7921736	A7901236	156.24
International	Super Chief (High Speed), Right Hand	16", 18"	462314R, 488265R, 58996C	M57-0352	270.82
International	Super Chief (High Speed), Left Hand	16", 18"	464603	464603	267.37
John Deere	HS314, HS324, HS354, HS434, HS444	14"	A20700	M57-0350	261.88
John Deere	HS316, HS326, HS356, HS436, HS446	16"	A20702	M57-0351	265.47
John Deere	NU-1048	18"	A17431	AA15673	337.68
John Deere	NU-1048, Left	18"	A17432	AA15674L	334.92
John Deere	NU-450 (metric)	18", 20"	32209	A32209M	332.03
John Deere	Switch Plow	24"	P57264	A57264	122.98
Massey	"N", "N" Heavy Duty	16", 18"	660204M1, 660206M	660204	260.93
Melroe/Morris	General Purpose, Oliver Bottom	16", 18"	6522185-HB	M57-0353	262.16
Melroe/Morris	General Purpose, Left	16"	G522185L	L61916	189.29
Minneapolis	Nife line	16", 18"	20P42	M57-0353	262.16
Oliver/White	419-619 Series	14"	R419-14	M57-0354	267.69
Oliver/White	419-619 Series	16"	R419-16	M57-0353	262.16
Oliver/White	619 Series, Left	16"	R419-16L	L61916	189.29
Oliver/White	619 Series	18"	R619-18	M57-0360	293.07
Wilrich	General Purpose	16", 18"	6522185-HB, 215177, A4258	M57-0353	262.16

PLOW SHINS - Bolts not included. See listing below for bolt ordering information.

Note:
All Shins are right hand unless otherwise noted in the "Size" column. Hardware not included.
Shins require (2) Grade 5, #3 Plow Bolts 7/16" x 1-1/4" or 1-1/2" long.

- Heat-Treated
- Sold Individually
- Painted Black Finish
- 1080 High Carbon Steel
- Hardware Not Included
- Solid Construction, 5/16" thick



Manufacturer	Models	Size	Bolt	Order No	List	Manufacturer's No.	Order No.	List
Allis Chalmers	387 Series	14, 16, 18"	3/8"	A 527846	1.51	347649	S30-0516	66.60
Baker	Switch Plow	18"	7/16"	A 484089	1.07	SB101	ASB101	34.89
DMI	Hydrawide - All	16", 18"	7/16"	A 484089	1.07	33111602	EP7490	23.78
Ford	General Purpose	12", 14", 16"				112136, 201344, 251435, 104428	104403A	21.32
Harrel	Switch Plow, Lower	18"				7920736	86CC	35.14
Harrel	Switch Plow, Upper	18"				9820736	A9820736	14.45
International	Super Chief, High Speed.	14, 16, 18"	7/16"	A 484089	1.07	488266R, 522325R	522325	25.21
International	Super Chief, High Speed, Left	14, 16, 18"	7/16"	A 484089	1.07	55075C	464595	30.73
John Deere	HS314, HS324, HS354, HS434, HS444, HS534, HS544	14"	7/16"	A 484089	1.07	A14700	8195A	27.37
John Deere	HS316, HS326, HS356, HS436, HS446, HS536, HS546, SD546	16"	7/16"	A 484089	1.07	A14702	8196AA	45.47
John Deere	NU-1036, NU-1046, NU-1048	16", 18"	7/16"	A 484089	1.07	A15594, A51081	A14883	26.27
John Deere	NU-1036, NU-1046, NU-1048, Left	16", 18"	7/16"	A 484089	1.07	A15606, A51082	A14887	32.80
John Deere	NU-400, NU-450 (metric)	All	7/16"	A 484089	1.07	A30129, A51080	A51080	54.82
John Deere	Switch Plow, Right	24"	7/16"			P57266	A57266	28.41
John Deere	Switch Plow, Left	24"	7/16"			P57265	A57265	28.41
Massey Ferguson	"N", "N" Heavy Duty	12, 14, 16, 18"	7/16"	A 484089	1.07	660008M91, 660020M1	660020	27.55
Melroe/Morris/Wilrich	General Purpose	16", 18"	7/16"	A 484089	1.07	6522182, 213032, A4257	EP7490	23.78
Melroe/Morris/Wilrich	General Purpose, Left	14", 16", 18"	7/16"	A 484089	1.07	6522182, 213032, A4257	217404L	39.22
Minneapolis Moline	Nife Line	14", 16"	7/16"	A 484089	1.07	7490	EP7490	23.78
National/David Brown	General Purpose	12", 14", 16"	7/16"	A 484089	1.07	7490, HS105	EP7490	23.78
Oliver, Minneapolis	225, 425, 625, Nife line	12, 14, 16, 18"	7/16"	A 484089	1.07	EP7488C	EP7488	23.40
Oliver	219, 419, 519, 619, 719	12, 14, 16, 18"	7/16"	A 484089	1.07	EP7490C	EP7490	23.78
Oliver	219, 419, 519, 619, 719, Left	12, 14, 16, 18"	7/16"	A 484089	1.07	217404BS	217404L	39.22
Oliver	549, 588, 598, 619 (deep till bottom)	18, 20"	7/16"	A 484089	1.07	230381B	220381B	34.65

LANDSIDES AND WEAR PADS

*Bolts/Nuts included. See pages 130 - 132 for bolt sizes.
Use #3 Head Plow bolts unless noted otherwise..



- 1/2" Thick
- Heat-Treated
- Sold Individually
- Painted Black Finish
- 1080 High Carbon Steel

Manufacturer	Model	Position	Type	Manufacturer's No.	Order No.	List
Baker	Switch Plow		LS	5B-102	ASB102	29.84
Baker	Short Switch Plow		LS	5B-103	ASB103	26.45
Ford	General Purpose (after 1958)	Front	LS	107980	107980*	43.17
Ford	General Purpose (after 1958)	Rear	LS	107981	107981	58.92
Harrel	Switch Plow. Front. 2-Hole	Small (4" x 6")	LS	79-010-36	A7920436	17.87
Harrel	Switch Plow. Rear. 4-Hole	Med (4" x 12")	LS	79-205-36	A7920536	34.54
International	Super Chief. 12-5/8" x 4-1/2" x 1/2"	Inner	-	59057, 1980672C2	L01-0100*	41.08
International	Super Chief. 6" x 4-1/2" x 1/2"	Outer	WP	59058C2	L01-0102*	20.24
International	Super Chief. 6" x 4-1/2" x 1/2"	RH & LH. Outer	WP	59058C1L	L01-0103*	18.05
International	Super Chief & Terra Flo	Front		522342R	522342	33.16
International	Super Chief & Terra Flo	Front. LH		522342L	522342L	34.71
John Deere	HS300, 400, 500, SDT, NU	Right	WP	AA15262, A16495 for 918011. Clipped head bolts.	A16493*	40.74
John Deere	HS300, 400, 500, SDT, NU	Left	WP	AA15263, A16496 for 1229565. Clipped head bolts.	AA15263L	23.48
John Deere	NU-400, NU-450 (metric)	-	WP	A27862, A45226	A27862*	53.08
John Deere	Switch Plow. 2-Hole	RH & LH Short	WP	A27862, A45226	A27862*	53.08
John Deere	Switch Plow. Front. 2-Hole	Front 1/2" x 4" x 6-1/2"	WP	P57046	A57046	16.22
John Deere			LS		A57052	29.43
John Deere	Switch Plow. Rear. 4-Hole.	.5" x 8" x 11.5"	LS	P57522	A57522	36.25
John Deere	Switch Plow. Rear. 3-Hole. 995 & 975	Rear. Large	LS	P60071	A60071	39.89
Massey Ferguson	"N" Heavy Duty, High Speed	Front	Inner	475153M1	495937*	80.19
Melroe	General Purpose	Medium. 15"	LS	6526000	L01-0151*	74.92
Melroe	6252600	Reversible	WP	6526852	L01-0152*	39.25
Oliver	419, 425, 619, 619 slat, 625	Old offset	LS	218270B	L01-0180*	75.28
Wilrich	General Purpose. Solid Inner Plate	15-7/16"x4-1/2"x9/16"	LS	215111, A4253	L01-0250*	65.91
Wilrich	General Purpose. 2-Hole	4-1/2" x 5-7/8"	WP	215225, A4256	L01-0251*	34.76

PLOWSHARES - RIBBED

Bolts not included. Plow shares are guaranteed against breakage for 1/2" of wear through the width of the plow share. Use Clipped Head bolts listed on page 148.
Made In The USA



- 3/8" Thick
- Heat-Treated
- Painted Black Finish
- 1080 High Carbon Steel
- Hardware Not Included
- Sold In Cartons of 6 Only, except Baker

Get the
Adams Edge™

Manufacturer	Model	Size	Bolt Size	Mfg. No.	Order No.	List
Allis Chalmers	387 Series 4-hole	14, 16"	(1)1/2", (3)7/16"	347749, 347750, 347751, 572181,	AM164RS	29.93
Allis Chalmers	387 Series 4-hole	18"	(1)1/2", (3)7/16"	573307, 347752	AM184RS	31.95
					AM184RSH*	71.64
Baker	Switch Plow	18"	(6) 1/2"	SB100	BA256RS	38.10
Baker	Switch Plow. Hardfaced Front Side	18"	(6) 1/2"	SB100	BA256RSHFS	122.93
Case	EX A, B, C, D, E 4-hole	16"	7/16"	T63194, T63195, RCase6R	OM164RS	29.93
Case	EX A, B, C, D, E 5-hole	18"	7/16"	RCase8R, T89974, T63097, T63133, T63206-RA18R	OM185RS	31.95
Ford	General Purpose 3-hole	12"	7/16"	105203A	FF123R5	31.95
Ford	Heavy Duty 3 & 4-hole	14"	7/16"	7100369, 201573, 201579, 201585, 201586	FF144RS	29.16
Ford	Heavy Duty 3 & 4-hole	16"	7/16"	7100370, 201575, 201581, 201587, 201588	FF164RS	29.93
Ford	Heavy Duty 5 hole	18"	7/16"	7101980, 201589, 201596	FF185RS	31.95
Ford	Heavy Duty 5 hole. Left Hand	18"	7/16"	7101980, 201589, 201596	FF185LRS	31.95
Ford	150, 151, 152, 154 4-hole	16"	7/16"	SBP219627BF, 215427DS	OM164RS	29.93
Ford	150, 151, 152, 154 4-hole short	16"	7/16"	SBP219627BF, 215427DS	OM164RS	29.93
Ford	150, 151, 152, 154 5-hole	18"	7/16"	SBP219629BF, 251565DS	OM185RS	31.95
Harrell	Switch Plow	18"	(5)7/16"	7900636	HA245RS	31.06
Harrell	Switch Plow. Hardfaced Back Side	18"	(5)7/16"	7900636	HA245RSHBS	104.55

*Hardfaced

PLOWSHARES - RIBBED

Bolts not included. Plow shares are guaranteed against breakage for 1/2" of wear through the width of the plow share. Bolts are listed on page 148.



Get the
Adams Edge™

- 3/8" Thick
- Heat-Treated
- Painted Black Finish
- 1080 High Carbon Steel
- Hardware Not Included
- Sold In Cartons of 6 Only, except Baker

Made In The USA

Manufacturer	Model	Size	Bolt Size	Mfg. No.	Order No.	List
International	Super Chief 4 hole short. Left hand	16"	(1)1/2", (3)7/16"	143241R1, 462223R11, 462227R11, 463241R1, 463233R1, 463253R1, 463237R1, 470957R1	IH164LRS	29.93
International	Super Chief 4 hole short	16"	(1)1/2", (3)7/16"	143241R1, 462223R11, 462227R11, 463241R1, 463233R1, 463253R1, 463237R1, 470957R1	IH164RS IH164RSH*	29.93 79.73
International	Super Chief 4-hole	16"	(1)1/2", (3)7/16"	462223R11, 462227R11, 463241R1, 463233R1, 463253R1, 463237R1, 470957R1	IH164RS IH164RSH*	29.93 79.73
International	Super Chief 4-hole. Left Hand. Inserted	18", 20"	(1)1/2", (3)7/16"	463254R, 463238R, 481960R1, 481964R1, 492081R1, 481961R1, 481965R1	IH184LRS IH184LRSH* IH184LRSH76	31.95 84.38 107.80
International	Super Chief 4-hole Inserted	18", 20"	(1)1/2", (3)7/16"	463254R, 463238R, 481960R1, 481964R1, 492081R1, 481961R1, 481965R1	IH184RS IH184RSH* IH184RSH76	31.95 31.95 31.95
John Deere	HS350, 400, 500, SDJ & NU Series 4-hole	14"	(1)1/2", (3)7/16"	A10225, A10222, A10226, A14221, A14222, A14225, A14226, A14321, A14322, A14025, A10325, A10326, A51498, A10221	JD144RS	29.16
John Deere	HS350, 400, 500, NU 4-hole short	14"	(1)1/2", (3)7/16"	A10225, A10222, A10226, A14221, A14222, A14225, A14226, A14321, A14322, A14025, A10325, A10326, A51498, A10221	JD144RS	29.16
John Deere	HS356, 400, 500, SDT, NU Series 4-hole. Left Hand.	16"	(1)1/2", (3)7/16"	A10227, A10224, A10228, A10327, A10323, A10324, A10328, A14027, A51500, A10223	JD164LRS	29.93
John Deere	HS356, 400, 500, SDT, NU 4-hole	16"	(1)1/2", (3)7/16"	A10227, A10224, A10228, A10327, A10323, A10324, A10328, A14027, A51500, A10223	JD164RS JD164RSH*	29.93 79.73
John Deere	HS356, 400, 500, SDT, NU 4-hole short	16"	(1)1/2", (3)7/16"	A10227, A10224, A10228, A10327, A10323, A10324, A10328, A14027, A51500, A10223	JD164RS JD164RSH*	29.93 79.73
John Deere	NU-1048 5-hole. Left Hand.	18, 20"	(4)7/16", (1)1/2"	A51506	JD185LRS JD185LRSH*	31.95 84.38
John Deere	NU-1048 5-hole	18, 20"	(4)7/16", (1)1/2"	AA51504	JD185RS JD185RSH*	31.95 84.38
John Deere	NU 450 (metric) 3-hole	18"	7/16"	A42808, A30951, A42807, A32222, A40408, A32221, A40407, A32217	JD183RS JD183RSH*	31.95 84.38
John Deere	Switch Plow	18"	(4)7/16"	P59129	JD244RS	31.06
John Deere	Switch Plow. Hardfaced Back Side	18"	(4)7/16"	P59130	JD244RSHBS	104.55
John Deere	Switch Plow. Hardfaced Front Side	18"	(4)7/16"	P59130	JD244RSHFS	104.55
Long	Switch Plow	18"	(5)7/16"	792800	LO245RS	38.10
Massey	"N" Heavy Duty 4-hole	16"	1/2"	475716M1, 475161M1	MF164RS	29.93
Massey	"N" Heavy Duty 4-hole. Left Hand.	18"	1/2"	475823M1	MF184LRS MF184LRSH*	31.95 60.11
Massey	"N" Heavy Duty 4-hole.	18"	1/2"	475823M1	MF184RS	31.95
Melroe/Morris	387 Series. Drop Front Hole. 4-hole.	16"	(1) 1/2", (3)7/16"	347749, 572184	AM164RS	29.93
Melroe/Morris	387 Series. Inline Hole. 4-hole.	16"	(1) 1/2", (3)7/16"	6527052	MR164RS	29.93
Melroe/Morris	387 Series. Drop Front Hole. 4-hole.	18"	(1) 1/2", (3)7/16"	573307	AM184RS AM184RSH*	31.95 71.64
Melroe/Morris	Star GP. 4-hole.	16"	(4)7/16"	6526832	MM164RS	29.93
Melroe/Morris	Star GP. 4-hole.	18"	(4)7/16"	6526829	MM184RS	29.93

*Hardfaced

TILLAGE

PLOWSHARES - RIBBED

Bolts not included. Plow shares are guaranteed against breakage for 1/2" of wear through the width of the plow share. Bolts are listed on page 148.

Made In The USA

Get the
Adams Edge.™



- 3/8" Thick
- Heat-Treated
- Painted Black Finish
- 1080 High Carbon Steel
- Hardware Not Included
- Sold In Cartons of 6 Only, except Baker

Manufacturer	Model	Size	Bolt Size	Mfg. No.	Order No.	List
Oliver/White	619, 625, 719, 819, 434	16"	(1) 1/2", (3) 7/16"	RCA6R, 219617BS	OC164RS	29.93
Oliver/White	619, 625, 719, 819, 434	18"	(1) 1/2", (4) 7/16"	RCA8R, 219619BS	OC185LRS	31.95
Case	3 & 4-hole. Left Hand.				OC185LRSH*	84.38
Oliver/White	619, 625, 719, 819, 434	18"	(1) 1/2", (4) 7/16"	RCA8R, 219619BS	OC185RS	31.95
Case	3 & 4-hole.				OC185RSH*	84.38
Oliver/White	619, 625, 719, 819, 434	14"	7/16"	RB14R, 219615BS, HD14FCO, RCase4S,	OM144RS	29.16
Case	3 & 4-hole, Nife line			220013BS, RCase4R,	OM144RSH*	80.63
Oliver/White	619, 625, 719, 819, 434	14"	7/16"	RB14R, 219615BS, HD14FCO, RCase4S,	OM144RS	29.16
Case	3 & 4-hole short			220013BS, RCase4R	OM144RSH*	80.63
Oliver/White	619, 719, 819, 919, 625,	16"	7/16"	RB16R, HD16FCO, 219617BS, RCase6S,	OM164LRS	29.93
Case	434 3 & 4-hole. Left Hand.			220016BS, RCase6R		
Oliver/White	619, 719, 819, 919, 625,	16"	7/16"	RB16R, HD16FCO, 219617BS, RCase6S,	OM164RS	29.93
Case	434 3 & 4-hole, Nife line			220016BS, RCase6R	OM164RSH*	79.73
Oliver/White	619, 719, 819, 919, 625,	16"	7/16"	RB16R, HD16FCO, 219617BS, RCase6S,	OM164RS	29.93
Case	434 3 & 4-hole short			220016BS, RCase6R	OM164RS	79.73
Oliver/White	619, 719, 819, 919, 625,	16, 18, 20"	7/16"	RA18R, 219619BS, HD18FCO, RCase8R,	OM185RS	31.95
Case	434 5-hole			220024BS, RCase8S	OM185RSH*	84.38
	Left hand				OM185LRS	31.95
Watts	All. 4-Hole. Left Hand.	All	7/16"	FO25	WA184LRS	31.95
Wilrich	GP. 4-Hole	18	1/2"	14255, 215806, 16047	WR184RS	31.95
					WR184RSH	84.36

*Hardfaced

SHARES - UPSET FORGED

Right handed, unless noted.



- 3/8" Thick
- Heat-Treated
- Painted Black Finish
- Sold In Cartons of 6 Only
- Long Wearing, High Carbon Steel

Manufacturer	Model	Size	Bolt Size	Mfg. No.	Order No.	List
International	Super Chief. 4-Hole	16"	(1) 1/2" x 1-3/8", (3) 7/16" x 1-1/4"	463237R1, 463241R1, 464343R1	S26-0141	53.33
International	Super Chief. 4-Hole	18"	(1) 1/2" x 1-3/8", (3) 7/16" x 1-1/4"	463238R1	S26-0142	64.64
John Deere	HS350, 400, 500, SDT, NU. 4-Hole	16"	(1) 1/2" x 1-1/4", (3) 7/16" x 1-3/16"	A10227, A10223, A10224, A10228	S26-0058	53.33
John Deere	NU 450 Metric. 3-Hole	18"	(3) M16 x M35	A42808, A30951	S26-0452	74.54
Oliver/White	619, 625, 718, 819 & 434. 4-Hole	16" Hvy Curved	(1) 1/2" x 1-3/8", (3) 7/16" x 1-1/4"	219615BS, RCA4R, RCA4S	S26-0302	53.33
Oliver/White	619, 625, 718, 819 & 434. 5-Hole	18" Hvy Curved	(1) 1/2" x 1-3/8", (4) 7/16" x 1-1/4"	219615BS, RCA4R, RCA4S	S26-0253	74.54
Wilrich	General Purpose. 4-Hole	18"	(4) 1/2" x 1-3/8"	215806, A4255	S26-0350	70.73

COULTERS - WAVY

Replaces Number	Application	Diam.	No. Waves	Wave Width	Gauge	Center Hole	Bolt Hole	Bolt Circle	Order Number	List
A72678	JD Max Emerge 2, Plus, Pro, XP, XP Pro, ME5, Exact Emerge	16"	12	3/4"	.185"	2.125"	5) .510"	4.75"	B45-1122	46.27
	JD Max Emerge	16"	12	3/4"	.185"	2.015" Slotted	6)4.06" x .469" & 3.375"	3.5"	B45-1123	46.27
D7803-12	Kinze	15-13/16"	12	3/4"	.177"	3.984"	4).531"	5.25"	B45-1124	41.00
A73911	JD Max Emerge	16"	8					3.5"	B45-1125	43.95
820-082C	Great Plains, White, Yetter	17"	12	3/4"	.157"	3.97"	4).531"	5.25"	B45-1120	38.90
55-318	Tye, DMI, Melroe, United Farm Tool Wilrich	17-5/8"	12	3/4"	.168"	3.640"	4).531"	5.0"	B45-1121	42.24

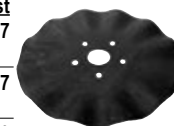

B45-1122

COULTERS - FLUTED / RIPPLED

Replaces Number	Application	Diam.	Gauge	Center Hole	Bolt Hole	Bolt Circle	Order Number	List
820-018C	Great Plains Yetter	17"	.138"	3.97"	4).531"	5.25"	B45-1135	42.89
N/A	DMI/Blue Jet	20"	7 GA	3-11/16"	8).531"	5 & 5-1/4"	B45-1140	62.29
	JD, Pioneer	17"	.157"	4"	4).5"	2.5"	B45-1704	42.79

B45-1135



COULTERS - PLAIN / FLAT

Replaces Number	Application	Diam.	Thickness	Center Hole	Bolt Hole	Bolt Circle	Order Number	List
N214190	JD 750, 1850, 1560, 1690, 1860	18"	.203"	3.031"	4).406"	4.375"	B45-3049	60.72
N283804	No Till Grain Drills 1890, 1895, 1990							
N283804	JD Drill Disc Opener	18"	.023"(5MM)		4	4.375"	B45-3049F	51.65
19-4500-1-2	Buffalo	18"	.157"	2.25"	6).390"	3.75"	B45-1185	40.27
F205112S	Brillion & Others	20"	5 GA	1.56" Sq.	N/A	N/A	B45-1150	85.62
F205112R	Glencoe & Others	20"	5 GA	1.56" Rd.	N/A	N/A	B45-1160	85.85
F225112R	Glencoe & Others	22"	5 GA	1.56" Rd.	N/A	N/A	B45-1162	116.72
	AC, Krause Chisel Plows	20.5"	3/16"	1.5" Rd.	N/A	N/A	2036	73.29

2036



FERTILIZER COULTERS

8 Bolt holes. 3-11/16" center hole.
5" and 5.25" bolt circle. Bolt hole size is .5313.



Description	Diameter	Thickness	Order No.	List
Crucible Fluted	20" x 4.5mm	.177"	B45-1130	65.80

COULTER - CONCAVE

Fits Buffalo. Replaces 3-4400-17.
Diameter: 14"
Gauge: .157"
Center Hole: 2.81"
Bolt Holes: 4
Bolt Hole Size: .406"
Bolt Circle: 4"

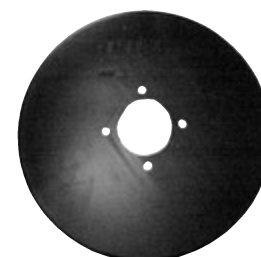

Order No.	List
B45-1186	34.26

STANDARD CONCAVITY, SOLID EDGE

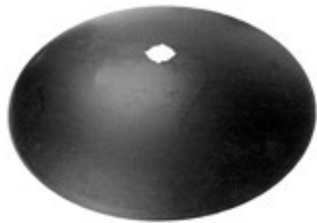

Gauge To Inch Conversion:

12 Gauge	=	.104" (2.6 mm)
11 Gauge	=	.119" (3 mm)
10 Gauge	=	.134" (3.4 mm)
9 Gauge	=	.149" (3.8 mm)
8 Gauge	=	.164" (4.2 mm)
7 Gauge	=	.179" (4.5 mm)
6 Gauge	=	.194" (5 mm)
5 Gauge	=	.209" (5.3 mm)
4 Gauge	=	.224" (5.7 mm)
3 Gauge	=	.236" (6 mm)

- Popular Sizes & Gauges Available
- Boron Steel, Accurately Hardened.
- Dual Punch Centers for Inventory Reduction.
- Precision Double Bevel for Superior Penetration.
- Backed by Herschel Warranty for Quality and Workmanship.

Diam.	Gauge	Hole Size	Concavity	Order No	List
16"	11 GA	7/8" Sq. x 1" Sq.	1-1/2"	B45-2001	28.24
16"	11 GA	7/8" Sq. x 1" Rd.	1-1/2"	B45-2007	28.24
16"	11 GA	1" Sq. x 1-1/8" Sq.	1-1/2"	B45-2003	28.24
16"	11 GA	1-1/8" Sq.	1-1/2"	B45-2009	28.24
18"	6 GA	1-1/8" Sq.	1-3/4"	B45-2140	50.57
18"	9 GA	7/8" Sq. x 1" Rd.	1-3/4"	B45-2030	45.71
18"	9 GA	1" Sq. x 1-1/8" Sq.	1-3/4"	B45-2024	45.71
18"	9 GA	1-1/8" Sq.	1-3/4"	B45-2028	45.71
18"	9 GA	1-1/8" Sq. x 1-1/4" Sq.	1-3/4"	B45-2025	45.71
18"	9 GA	1-1/4" Sq. x 1-1/2" Rd.	1-3/4"	B45-2023	45.71
18"	7 GA	1-1/8" Sq.	1-3/4"	B45-2181	50.20
18"	7 GA	1-1/8" Sq. x 1-1/4" Sq.	1-3/4"	B45-2015	50.20
18"	9 GA	7/8" Sq. X 1" Sq	1-3/4"	B45-2243	45.71
20"	6 GA	1-1/8" Sq.	2-1/4"	B45-2142	66.89
20"	7 GA	1" Sq x 1-1/8" Sq	2-1/4"	B45-2040	66.38
20"	7 GA	1-1/8" Sq.	2-1/4"	B45-2043	66.38
20"	7 GA	1-1/8" Sq. x 1-1/4" Sq.	2-1/4"	B45-2042	66.38
20"	7 GA	1-1/4" Sq. x 1-1/2" Rd.	2-1/4"	B45-2044	66.38
20"	7 GA	1-1/2" Sq x 1-3/4" Rd.	2-1/4"	B45-2045	66.38
20"	9 GA	1" Sq. X 1-1/8" Sq	2-1/4"	B45-2139	57.41
22"	7 GA	1-1/8" Sq. x 1-1/4" Sq.	2-1/2"	B45-2052	74.42
22"	7 GA	1-1/4" Sq. x 1-1/2" Rd.	2-1/2"	B45-2048	74.43
22"	7 GA	1-1/2" Sq. x 1-3/4" Rd.	2-1/2"	B45-2049	74.43
22"	7 GA	2" Rd.	2-1/2"	B45-2238	74.42
22"	6 GA	1-1/8" Sq. x 1-1/4" Sq.	2-1/2"	B45-2145	79.47
22"	6 GA	1-1/8" Sq.	2-1/2"	B45-2149	79.47
22"	1/4"	1-1/8" Sq. x 1-1/4" Sq.	2-1/2"	B45-2100	92.86
22"	1/4"	1-1/4" Sq. x 1-1/2" Rd.	2-1/2"	B45-2107	92.86
22"	1/4"	1-1/2" Sq. x 1-3/4" Rd.	2-1/2"	B45-2105	92.86
22"	1/4"	1-1/8" Sq	2-1/2"	B45-2111	92.86
22"	1/4"	2" RD		B45-2087	92.86
22"	7 GA	1-1/8" Sq.	2-1/2"	B45-2196	74.42
22"	6 GA	1-1/2" Rd.	2-1/2"	B45-2242	79.47
22"	1/4"	2-5/16" Rd.	2-1/2"	B45-2247	92.86
24"	1/4"	1-1/8" Sq. x 1-1/4" Sq.	3-1/4"	B45-2070	122.54
24"	1/4"	1-1/4" Sq. x 1-1/2" Rd.	3-1/4"	B45-2074	122.54
24"	1/4"	1-1/2" Sq. x 1-3/4" Rd.	3-1/4"	B45-2075	122.54
24"	1/4"	1-1/2" Sq.	3"	B45-2160	122.54
24"	1/4"	1-1/8" Sq.	3-1/4"	B45-2113	122.54
24"	1/4"	2 Rd.	3-1/2"	B45-2109	122.54
24"	5/16"	1-1/2" Sq. x 1-3/4" Rd.	3-1/4"	B45-2265	153.10
24"	1/4"	1-3/4" RD	3-1/4"	B45-2115	122.54
26"	1/4"	1-1/2" Sq. x 1-3/4" Rd.	3-1/2"	B45-2120	150.59
26"	1/4"	1-1/2" Rd.	3-1/2"	B45-2252	150.59
26"	1/4"	2 Rd.	3-1/2"	B45-2091	150.59

STANDARD CONCAVITY, NOTCHED EDGE



Gauge To Inch Conversion:

12 Gauge	=	.104" (2.6 mm)
11 Gauge	=	.119" (3 mm)
10 Gauge	=	.134" (3.4 mm)
9 Gauge	=	.149" (3.8 mm)
8 Gauge	=	.164" (4.2 mm)
7 Gauge	=	.179" (4.5 mm)
6 Gauge	=	.194" (5 mm)
5 Gauge	=	.209" (5.3 mm)
4 Gauge	=	.224" (5.7 mm)
3 Gauge	=	.236" (6 mm)

- Popular Sizes & Gauges Available
- High Carbon Steel, Accurately Hardened.
- Dual Punch Centers for Inventory Reduction.
- Precision Double Bevel for Superior Penetration.
- Backed by Herschel Warranty for Quality and Workmanship.

Diam.	Gauge	Hole Size	Concavity	Order No	List
16"	11 GA	7/8" Sq. x 1" Sq.	1-1/2"	B45-2002	28.31
16"	11 GA	1" Sq. x 1-1/8" Sq.	1-1/2"	B45-2004	28.31
18"	7 GA	1-1/8" Sq. x 1-1/4" Sq.	1-3/4"	B45-2016	50.45
18"	7 GA	1-1/8" Sq.	1-3/4"	B45-2233	50.45
18"	9 GA	7/8" Sq. x 1" Sq.	1-3/4"	B45-2244	45.80
18"	9 GA	7/8" Sq. x 1" Sq.	1-3/4"	B45-2244	45.80
18"	9 GA	7/8" Sq. x 1" Rd.	1-3/4"	B45-2027	45.80
18"	9 GA	1" Sq. x 1-1/8" Sq.	1-3/4"	B45-2021	45.80
18"	9 GA	1-1/8" Sq. x 1-1/4" Sq.	1-3/4"	B45-2026	45.80
18"	1/4"	1-1/2" Sq.	1-3/4"	B45-2018	55.22
20"	7 GA	7/8" Sq. x 1" Rd.	2-1/4"	B45-2061	66.89
20"	7 GA	1" Sq. x 1-1/8" Sq.	2-1/4"	B45-2041	66.89
20"	7 GA	1-1/8" Sq.	2-1/4"	B45-2199	66.89
20"	7 GA	1-1/8" Sq. x 1-1/4" Sq.	2-1/4"	B45-2046	66.89
20"	7 GA	1-1/4" Sq. x 1-1/2" Rd.	2-1/4"	B45-2047	66.89
20"	7 GA	1-1/8" Sq.	2-1/4"	B45-2199	66.89
22"	7 GA	1-1/2" Sq.	1-3/4"	B45-2020	65.25
22"	7 GA	1-1/8" Sq.	2-1/2"	B45-2203	75.29
22"	7 GA	1-1/8" Sq. x 1-1/4" Sq.	2-1/2"	B45-2051	75.29
22"	7 GA	1-1/4" Sq. x 1-1/2" Rd.	2-1/2"	B45-2055	75.29
22"	7 GA	1-1/2" Sq. x 1-3/4" Rd.	2-1/2"	B45-2056	75.29
22"	6 GA	1-1/8" Sq.	2-1/2"	B45-2147	79.94
22"	6 GA	1-1/8" Sq. x 1-1/4" Sq.	2-1/2"	B45-2148	79.94
22"	6 GA	1-1/2" Sq. x 1-3/4" Rd.	2-1/2"	B45-2146	79.94
24"	1/4"	1-1/8" Sq. x 1-1/4" Sq.	3-1/4"	B45-2071	122.98
24"	1/4"	1-1/4" Sq. x 1-1/2" Rd.	3-1/4"	B45-2076	122.98
24"	1/4"	1-1/2" Sq. x 1-3/4" Rd.	3-1/4"	B45-2077	122.98
24"	1/4"	1-1/2" Sq	3-1/4"	B45-2078	122.98
26"	1/4"	1-1/2" Sq. x 1-3/4" Rd.	3-1/2"	B45-2122	153.10
26"	5/16"	1-1/2" Sq. x 1-5/8" Rd.	3-1/2"	B45-2228	170.67

Additional Sizes Available.
Call Customer Service To Order!

CONE STYLE, SOLID EDGE - JD

3.87" Concavity



Diam.	Thickness	Hole Size	Order No.	List
22"	7 GA	1-1/8" Sq. x 1-1/4" Sq.	B45-2097	66.59
22"	7 GA	1-1/8" Sq. x 1-1/4" Sq.	B45-2098	75.29
24"	1/4"	1-1/2" Sq.	B45-2072	125.49
26"	1/4"	1-1/4" Sq. 4-3/4" Concavity	B45-2123	150.59
26"	1/4"	1-1/2" Sq. 4-3/4" Concavity	B45-2119	150.59

CONE STYLE, NOTCHED EDGE - JD

3.87" Concavity



Diam.	Thickness	Hole Size	Order No.	List
22"	7 GA	1-1/8" Sq. x 1-1/4" Sq.	B45-2099	77.80
24"	1/4"	1-1/2" Sq.	B45-2073	125.77
26"	1/4"	1-1/4" Sq. 4-3/4" Concavity	B45-2124	153.10
26"	1/4"	1-1/2" Sq. 4-3/4" Concavity	B45-2121	153.10

FLAT CENTER STYLE, SOLID EDGE - IH

2" Concavity

B45-2092



Diam.	Thickness	Hole Size	Order No.	List
20"	7 GA	1-1/8" Sq.	B45-2092	66.59
22"	7 GA	1-1/8" Sq.	B45-2094	75.29
22"	6 GA	1-1/8" Sq.	B45-2159	80.60
22"	6 GA	1-1/2" Sq.	B45-2250	80.61
22"	1/4"	1-1/2" Rd	B45-2266	95.37
24"	1/4"	1-1/8" Sq. x 1-1/4" Sq	B45-2259	122.54
26"	1/4"	1-1/2" Sq.	B45-2261	150.59

FLAT CENTER STYLE, NOTCHED EDGE - IH

2" Concavity

B45-2093



Diam.	Thickness	Hole Size	Order No.	List
20"	7 GA	1-1/8" Sq.	B45-2093	66.89
22"	7 GA	1-1/8" Sq.	B45-2095	77.80
22"	6 GA	1-1/8" Sq.	B45-2158	80.31
22"	6 GA	1-1/2" Rd.	B45-2251	80.31
26"	1/4"	1-1/8" Sq.	B45-2258	153.10

SPECIAL CONCAVITY, NOTCHED EDGE

Miller and New Holland
Front disc blade. 2-5/8" concavity

B45-2082



Diam.	Thickness	Size	Order No.	List
24"	1/4"	1-1/2" Sq. x 1-3/4" Rd.	B45-2082	70.75

NORWOOD & JOHN DEERE HIGH SPEED DISCS

Fits **NORWOOD KWIK-TILL** HSD800, HSD1000, HSD1600, HSD1775, HSD2100, HSD2450, HSD2500, HSD3000, HSD3500, HSD4000, HSD4500. Fits **JOHN DEERE** 2680H High Performance Discs

Description	Thickness	Replaces	Order No.	List
20" NOTCHED 4-HOLE 7" FLAT CENTER	6MM	90-34-0002, 5NS90340002	B45-2746	99.48
20" PLAIN EDGE 4-HOLE 7" FLAT CENTER	6MM	90-34-0003, 5NS90340003	B45-2748	93.80



B45-2746



B45-2748

TILLAGE

HARRELL CROP CHOPPERS

- OEM Quality
- 3/8" Heat Treated High Carbon Steel
- (4) .7" x 1.65" Bolt Holes

Size	Replaces	Order No	List
24"	HA9301175	B45-2324	90.40
36"	HA9300575	B45-2336	130.81
38"	HA9300775	B45-2338	135.07

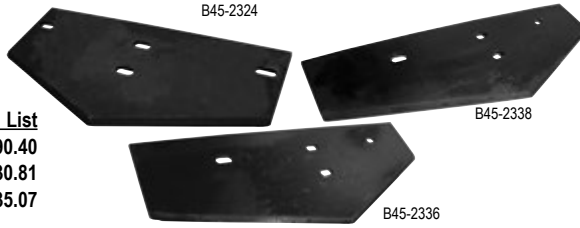

COTTON STALK PULLER/CHOPPER BLADES

Replacement Blade Only with 12 Welded Cleats, 1/4" x 3" x 3". Fits Besler & Sundance. Replaces PP28 and SC7. 27-3/8" diameter. 1/4" Thick.

Center Hole	Bolt Hole	Bolt Circle	Order Number	List
4.688"	.515" (6)	6"	B45-2300	260.20



Fits Amadas Cotton Stalk Choppers. 20" Long 8" wide at point 5" wide at ends 3/8" thick with (3) 1/2" slotted mounting holes. Replaces 61517.

Order Number	List
B45-2320	53.87



Disc Harrow Bearing Identification Code

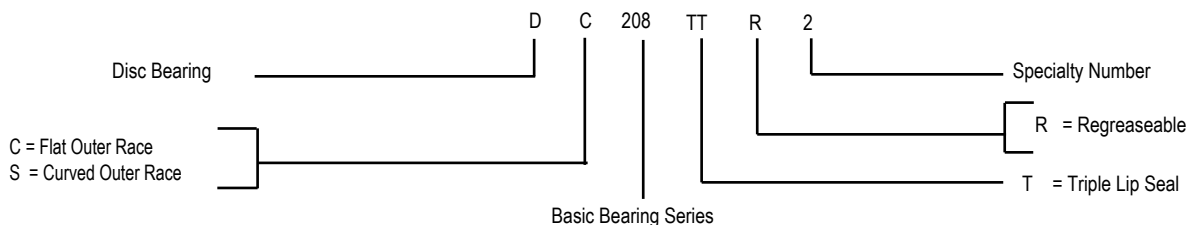

FLAT OUTER RACE - DC SERIES

BCA Number	Bore Size (A)	Outer Diam. (B)	Outer Race Width (C)	Inner Race Width (D)	Order No	List
DC208TT5	1-1/8", SQ	3.1496"	.709	1.438	B15-3180	29.43
DC208TT8	1-1/8", SQ	3.1496"	1.185	1.438	B15-3190	31.95
DC208TTR17	1-1/8" RD	3.376"	1.438	1.188	B15-3157	19.06
DC211TT3	1-1/2", SQ	3.397"	1.313	1.313	B15-3184	38.35
DC211TTR3	1-1/2", SQ	3.397"	1.313	1.313	B15-3188	42.73

CURVED OUTER RACE - DS SERIES

BCA Number	Bore Size (A)	Outer Diam. (B)	Outer Race Width (C)	Inner Race Width (D)	Order No	List
DS208TT6	1", SQ	3.158"	.709	1.438	B15-3176	36.06
DS208TT5	1-1/8", SQ	3.1496"	.709	1.438	B15-3050	27.89
DS208TT8	1-1/8", SQ	3.1496"	1.188	1.438	B15-3110	36.00
DS208TTR8	1-1/8", SQ	3.150"	1.188	1.438	B15-3186	32.45
DS208TT12	1-1/8", SQ	3.4340"	1.188	1.438	B15-3170	34.26
DS210TTR4	1-1/8", SQ	3.5433	1.188	1.188	B15-3144	59.23
DS208TT7	1-3/16", RD	3.1496"	.709	1.188	B15-3080	35.17
DS209TT5	1-1/4", SQ	3.347"	1.188	1.438	B15-3185	52.86
DS209TT4	1-1/2", RD	3.3465"	1.188	1.188	B15-3120	38.38
DS211TTR3	1-1/2", SQ	3.397"	1.313	1.313	B15-3187	49.80
DS211TT3	1-1/2", SQ	3.9370"	1.313	1.313	B15-3150	33.49
DS209TTR10	1-3/4", RD	3.3465"	.866	1.438	B15-3130	41.25

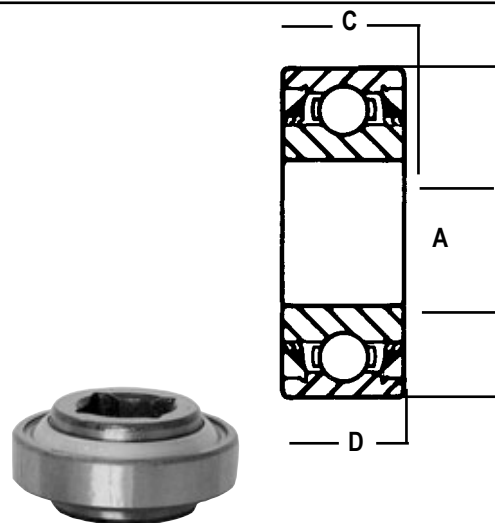

All Herschel heavy duty disc bearings feature long lasting triple lip seals.

RIVETED 4-BOLT FLANGE -- FD SERIES

BCA Number	Bore Size (A)	Order No	List
FD209RA, ST491A	1-3/4", RD	B15-3010	46.78
FD209RB	1-1/2", RD	B15-3179	38.95

TILLAGE - DISC BEARINGS DC SERIES

Order Number	OEM Number	B.C.A. Part No.	Fafnir Number	Bore Size / Type	Mfr.	Application	
B15-3155	L-512-B	DS208TT11	W208PPB11	7/8" SQ.	Blanton	Disc Harrow	
	BB2			Sealed	King	Disc Harrow	
	990093				Long	Disc Harrow	
	206090				Taylorway	Disc Harrow	
	T603				Tuflin	Disc Harrow	
B15-3176	11079	DS208TT6	W208PPB6	1" SQ	Amco	LFB2, LFB2, LTB2	
	14-22-63			Sealed	Athens		
	T15820				Bush Hog		
	710152				Case	Small Ridger	
	834367M1, 1025130M1				Hesston	Disc Harrow	
	6519831					M. F.	21 Disc Harrow
	552207					Melroe	
B15-3161	20H4027	DS208TT9	W208PPB9	1" SQ.	Oliver	Disc Harrow	
				Sealed	White	Disc Harrow	
B15-3180	7129	DC208TT5	W208PP5	1-1/8 SQ	Athens	Ridger	
	GA15			Sealed	Bingham	Bedder	
	7129				Blanton	Disc Harrow	
	9554A				Burch	Ridger, 8 Row	
	16-1-176, 795006				Bush Hog	Bedder & Ridger	
					Charles Mach.	Trencher	
	H747139				Case	Trencher	
	JD9350				Deere	F871, F901, F984, F981, F982 Bedder	
	X08738, X09838				Deutz-Allis	Ridger	
					Forest City	Disc Harrow	
					Hester		
	963889R91				IH/Case		
	06A51-001				Kelly	Coulter	
	B8018				Kewanee		
					Minn-Moline	Hipper, Ridger	
		Multi-Purpose	Ridger				
		Piper	Disc Harrow, Ridger				
		Taylor					
		Towner	100, 101 Ridger				
		Tye					
		W & A Mfg.	Ridger & Does More				
B15-3190	BC1	DC208TT8	W208PP8	1-1/8" SQ	Blanton		
	9C16			Sealed	Brillion		
	AA14878				Deere	23, 2FK, F871, F901, F902, F984 Bedders	
B15-3050	BC1	DS208TT5	W208PPB5	1-1/8" SQ	King Plow		
	10272			Sealed	Amco	WTD5, WTD6, LFD2, LFD82 Disc	
	2J516				Athens	Ridger	
	J9373				Brillion		
					Burch	Ridger, E-Z Set, E-2GO, Early	
					Caldwell	1-1/8 Axle Models	
	T16288				Case		
					Chatanooga		
	JD9248, A20175				Deere	8500, F810H, F850H	
	GK260				Dunham	Disc Harrow	
	261750				Eversman		
	1R41009				Farmhand		
	630210R91				IH/Case	Ridger	
	06A51001				Kelly		
	B7980, G0052604				Kewanee	206, 400 Disc	
		Krause					
843638M1, 190566M1		M. F.					
NDAS4508BJ		N.H. (Ford)					
744-P		Pico	LO, 175, 185, 200, 206, 300, LT400, 720				
24A5301		Sunflower					
T60		Tuflin	Disc Harrow, 1-1/8 Gang Bolt				
B15-3110	10333	DS208TT8	W208PPB8	1-1/8" SQ	Amco	WTD10, WTD3, WTD4 Disc	
	9C16			Sealed	Brillion		
	T25486				Case		
	JD9286, JD9300				Deere		
	X10928				Deutz-Allis		
	213778B				New Idea		
	T151				Talbot		
	7906				Toner	101 Ridger	
B15-3186	G10333	DS208TTR8	GW208PPB8	1-1/8" SQ	Amco	13-1/2 Pulverizing Disc	
	SBP238481B			Relube	Ford	241, 242, 243, 246, Disc Harrows	
	B2151				Kewanee	500, 600 Disc	
	SBP238481B				New Holland		
	238481B				Oliver	263 Disc	
	207359				Taylor	200000, Series Disc	

Order Number	W238481B OEM Number	B.C.A. Part No.	Fafnir Number	Bore Size / Type	White Mfr.	Application
B15-3170	1023	DS208TT12	W208PPB12	1-1/8" SQ	Blanton	Square Axle Disc
	14-24-26			Sealed	Bush Hog	Disc Harrow
	T28503				Case	Disc Harrow
	ST607, ST658				Case/IH Dunham	Disc Harrow (Wide O.R.)
	266740				Eversman Hardee IMCO	Disc Harrow Wheel Disc
	BB-2N				King Plow	KGB, WGH, EZB, MFB Disc Harrow
	37-61-001				Lilliston	
	9-90092				Long	958, 959 Disc
	447899M1				M. F. McClesky Rome Southern	34MTD & 33 Rev. Disc F228, L150 Harrow 7-1/2 Disc Harrow Disc Harrow, 13' Pulv. Disc
	204147				Taylor	Disc Harrow Light Duty 12-1/2, 19 & 21
B15-3156	15013				Towner	101 Ridger 420, 425 Disc
	T602				Turfline	Disc Harrow 1-1/8
	G10272	DS208TTR5	GW208PPB5	1-1/8" SQ.	AMCO	Disc Harrow
B15-3157	A20175				John Deere	Disc Harrow
	207359				Taylorway	Disc Harrow
B15-3144	142416BHIMP	DC208TTR17	GW208PP17	1-1/8" SQ.	Bush Hog	Disc Harrow
	1436183BHIMP			Relube	Bush Hog	Disc Harrow
B15-3144	B2246	DS210TTR4	GW210PPB4	1-1/8" SQ	Kewanee	100, 1025, 1100, 1200 Disc
				Relube		
B15-3080	430796	DS208TT7	W208PPB7	1-3/16" RD	Deutz-Allis	
	40-102			Sealed		
	P-212-10-2				Krause	Disc Harrow
	9-90155				Long	
	237092B				Oliver	241,352,250 Series Wheel Disc
B15-3165	30-1005197, 1186				Sunflower	
	237092B				White	
B15-3125	4050006, 4061005	DS208TTR10	GW209PPB8	1-1/4" SQ. Relube	Lilliston	Disc Harrow
B15-3185	5449031	DS209TTR5	GW209PPB5	1-1/4" SQ	Caukins	
	842342M1			Relube	M. F. Taylor	Disc Harrow
B15-3185	JD8664	DS209TT5	W209PPB5	1-1/4" SQ	Deere	9000 Drill, 4400 Combine
	126-068		FMC	Sealed	FMC	Harvester
	842303M1				M. F. Piper	520, 620 Disc Harrow Do-All
B15-3184	11071	DC211TT3	W211PP3	1-1/2" SQ	Amco	516, 517, F15 Disc Harrow
				Sealed	Athens	Levee Plow, 1st Series
	H747444				Case	Trencher
	MULCBB112				Deutz-Allis	K7 Disc
	B2055				Domries	1-1/2" Axle Series
	1905678M1				Ford	219, 223 Cutting Disc
B15-3188	6510628				Kewanee	Disc Harrow
	G11071	DC211TTR3	GW211PP3	1-1/2" SQ	M. F. Melrow	Disc Harrow
					Amco	WOF3, WOF5, WOF6, WOJ3, WOJ4, Offset Disc
	14-6-430				Relube Athens	Disc Harrow
	T51653				Bush Hog	145, 146, 246, 1435, 1437 w/1-1/2" gang bolt
B15-3150	G1046430				Case	E30, G109, G110, G119, K23, K23A Disc Harrow
	481213				Greenline	Disc Harrow
	3J131	DS211TT3	W211PPB3	1-1/2" SQ	Kewanee	
	203214			Sealed	W & A Mfg.	
	7377-1				Brillion	
	MULCB112SG				Burch	Offset Disc
	630095R91, ST627A, 6395R				Farmhand	
B15-3187	832540M1				Ford	236 Cutting Disc
	4404-P					
	G10906	DS211TTR3	GW211PPB3	1-1/2" SQ	H/Case	New Ground Disc
				Relube	M. F.	38, 41, 42 Disc Harrow
	78672A				Pico	HD Levee Plow, WO Series
	T51610					Disc Harrow
	70583939				Amco	Disc Harrow, New Ground Disc
	9-92088				Athens	Offset Disc, Super Tandem
	449432M1				Burch	K23, K23A, G59 Disc
	207022				Case	2600 Disc
237909B				Deutz-Allis		
				Long		
				M. F.	30,40,520,620,720 Disc Harrow	
				Taylor	Disc Harrow, Heavy Duty	
				White		

TILLAGE - DISC BEARINGS DS SERIES

Order Number	OEM Number	B.C.A. Part No.	Fafnir Number	Bore Size / Type	Mfr.	Application
B15-3181		DS211TT6	W211PPB6	1-1/2" SQ	Athens	Levee Plow, 2nd Series
	204-82			Sealed	Burch Chatanooga	Super Tandem 1973-Up Levi, Levi-Dyke Plow
	9-90241				Long	958, 959, 960, 1090 Disc Harrow
	204679				Taylor	Disc Harrow, Extra HD
	18300				Towner	510, 515, 577, 532, 534, 535, 560, 600, 620, 621, 630
B15-3163		DS208TT2A	W208PPB2	1-1/2" RD. Sealed	MF	Disc Harrow
B15-3179	1A64318	FD209RB	DHU1-1/2 R209	1-1/2" RD	Farmhand	Disc Harrow
	700613			Relube	Hesston	Disc Harrow
	FC0481				Kent	Disc Harrow
	40-109				Krause	Disc Harrow
	1065010011				Landoll	Disc Harrow
	91134				Unverferth	Disc Harrow
	W238813				White	Disc Harrow
B15-3182	85481014	DC211TT5	W211PP5	1-1/2" SQ	Badger	3100, K, KT, WKT Disc
	406677			Sealed	Deutz-Allis	
B15-3120	340103	DS209TT4	W209PPB4	1.535" RD	Farmhand	Disc Harrow
	40-104, P412-10-2			Sealed		
	34002				Krause M. F. Wil Rich	Disc Harrow
B15-3124	AN240220	DS209TTR4	GW209PPB4	1.535 RD	Deere	
	21842400			Relube	DMI	
	EP6576				Farmhand	
	05A51001				Kelly	
	40-105, 612-10-2				Krause	Disc Harrow
	1065010003				Landoll	
	1829				Sunflower	
B15-3130	A20649	DS209TTR10	GW209PPB11	1-3/4" RD Relube	Deere	210, 220, 230 Disc
B15-3010	ST491A	FD209RA	DHU491A	1-3/4" RD Relube	IH/Case	315, 330, 350, 370, 470, 475, 480, 485, 490, 496, 610
B15-3160		DC211TTR14	GW211PPB13	1-3/4" Rd.	Sunflower	Disc Harrow
				Relube	Miller	Disc Harrow
B15-3162		DS210TT5	GW210PPB5	1-3/4" RD. Relube	Krause	Disc Harrow
B15-3166	7200460	DS208TTR2	GW209PPB2	1-3/4" RD.	Ford	Disc Harrow
	B7778			Relube	Kewannee Miller	Disc Harrow Disc Harrow
B15-3178	14-4-5	DS209TT2	W209PPB2	1.7717" RD	Bush Hog	1432, 1436 Disc
	H747410			Sealed	Case	Trencher
	430478				Deutz-Allis	Disc Harrow
	310072				Farmhand	Disc Harrow
	113903				Ford	204, 210, 224, 230 Disc
	1251062C91				IH/Case	Disc Harrow
	835050M1				M. F.	28, 33, 34, 68 Disc Harrow
	20H2152				Minn-Moline Shaffer	Disc Harrow Disc Harrow
	7044				Unverferth	Disc Harrow
	B15-3142	G10771	DS210TTR2	GW210PPB2	1-15/16" RD	Amco
T53781				Relube	Case	F21, F21H Disc Harrow
G10771					Farmhand	Disc Harrow
B15-3159	14-50-5	DC210TTR9	GW210PP9	1-15/16" SQ. Relube	Bush Hog	Disc Harrow
B15-3183	11052	DS210TT2	W210PPB2	1-15/16" RD	Amco Burch Sealed	Disc Harrow EZ, EZ-A, EZ-B, 145 Disc, 30565 Kwik Set Hipper/Ridger
	14-5-109				Bush Hog	145
	K85				Domries	
	10771				Farmhand	
	177849				Ford G & M	3 PT Vinyard Disc Plow
	831960M3				M. F. Shaffer	Disc Harrow Strathmore
	3055,3056					
	408808D				White	
		DC210TT2	W210PP2	1-15/16"RD Sealed	Amco White Domeries	
B15-3177	T57559	DS211TTR2	GW211PPB2	2-3/16" RD	Case	
	24022			Relube	Wil Rich	Disc Harrow
B15-3189	GW211PP2S				Sunflower	
	DC211TT2S					
B15-3158		DC211TTR2	GW211PP2	2-3/16" RD.	Athens	Disc Harrow
	146244BHIMP			Relube	Bush Hog John Deere	Disc Harrow Disc Harrow
	B2289				Kewannee	Disc Harrow
B15-3164	430480	DS211TT2	W211PPB2	2-3/16" RD.	Allis Chalmers	Disc Harrow
	H747170			Sealed	Case	Disc Harrow
	958334R91				IH	Disc Harrow
					Wilbeck	Disc Harrow

CASE-IH



OEM Number	Description	Application	Order No.	List
468584R2	Bumper Washer	Fits 46, 48, 150, 330, 350, 370, 470, 475, 480, 485, 490, 496	H468584R2	35.64
1344908C1	Bumper Washer	1-1/2" Round Hole Fits Case IH Disc Harrow 3900 Series, 3800, 3850, RMX340	H1344908C1	27.39
481611R1	End Washer	Fits Models 132, 150, 330, 350, 370, 470, 475, 480, 485, 490, 610	H481611R1	11.53
PA4167	End Washer	Fits Models 132, 150, 330, 350, 370, 470, 475, 480, 485, 490, 610	HPA4167	9.99
472592R3	Spool	1-5/8" SQ HOLE 7-1/2". Fits Old Style 37, 46, 48, 60, 61, 120, 122, 130, 132, 150, 350, 370, 470, 480	H472592R3	17.68
472593R3	Spool	3" SQ HOLE 9" SPACING. Fits Old Style 37, 46, 48, 60, 61, 76, 120, 122, 130, 132, 150, 330, 350, 370, 470, 480, 610, 760	H472593R3	20.25
472591R3	Spool	4" SQ HOLE 7-1/2" & 9". Fits Old Style 37, 46, 48, 60, 61, 76, 120, 122, 130, 132, 150, 330, 350, 370, 470, 480, 610	H472591R3	22.81
101189C1	Spool	1-5/8" RD HOLE 7-1/2". Fits New Style 350, 370, 470, 475, 485, 190, 496, 3800 & 3900	H101189C1	17.68
101190C1	Spool	3" RD HOLE 9" SPACING. Fits New Style 132, 350, 475, 485, 490, 496, 3800 & 3900	H101190C1	20.25
101191C1	Spool	4" RD HOLE 7-1/2" & 9". Fits New Style 132, 350, 370, 470, 475, 485, 490, 496, 3600 & 3900	H101191C1	19.80
481416R1	Spool	7-1/2" SQ HOLE. Fits Models 46, 48, 60, 61, 120, 122, 130, 132, 150, 330, 350, 370, 470, 475, 480, 485, 490 & 496	H481416R1	48.44
481417R1	Spool	9" SQ HOLE. Fits Models 37, 46, 48, 60, 61, 120, 122, 130, 132, 150, 330, 350, 370, 470, 475, 480, 485, 490 & 496	H481417R1	45.88
652383R1	5-1/16" Sleeve	Fits Models 470 & 480 (11 ga. tubing)	H652383R1	4.86
652412R1	7-1/4" Sleeve	Fits Model 490 (11 ga. tubing)	H652412R1	6.31
112410C1	8-3/4" Sleeve	Fits Model 470, 475, 480, 485, 490 & 495 (11 ga. tubing)	H112410C1	8.11
129532C2	Holder	Fits Models 490, 496, 3800 & 3900	H129532C2	107.39
121119C92	Scraper RH	Fits Models 475, 90, 496, 3900	H121119C92	22.81
121120C92	Scraper LH	Fits Models 475, 90, 496, 3900	H121120C92	22.81
195938	Scraper LH	Heavy Duty, For Case IH Disc Models 496-3900, RMX340	H195938A1	37.00
195938A1	Scraper RH	Heavy Duty, For Case IH Disc Models 496-3900, RMX 340	H195939A1	37.19
195939	Scraper RH	Heavy Duty, For Case IH Disc Models 496-3900, RMX 340	H195916A2	15.86
195939A1	Scraper	Heavy Duty, For Case IH Disc Models 3900 Series RMX, 340	H121118C1	9.99
195916A2	Scraper	Heavy Duty, For Case IH Disc Models 3900 Series RMX, 340	H121118C1	9.99
121118C	Blade Only	For Scraper, Made of Spring Steel, Fits Case IH Disc Harrow Models 475, 485, 490, 496, 760, 3800, 3900, 3950, RMX340	H121118C1	9.99
	Square Taper Bearing Roller Set	1-1/8"; W/2 Bearings, 2 Races, 2 Seal For Kewanee Disc Models 100,200,300, IH Models 48 Disc	H13678	97.52
	Wheel Bearing Kit	Consists of Inner Cup LM48510, Inner Bearing LM48548, Outer Cup M12610, Outer Bearing M12649, Seal 200886, Cap 909917 and Retainer 667564.	H63881K	28.53
	Wheel Bearing Kit	Retainer-667564, Inner Cup-LM501310, Inner Bearing-LM501349 Outer Cup-LM67010 Outer Bearing-LM67048 Seal-594702 Cap-P10025, Fits Case IH Disc Harrows, Specifically the P606468 Hub	H123096	38.18
606468R21	Hub With Cups	With Inner Cup LM501310, Outer Cup LM67010, 6 Bolt Holes, For Case IH Disc Harrows, Fits Models 485, 496, 501, 760, 770, 3800, 3850, 3900, 3950, For Case-IH field cultivator transport wheels on 45 (over 13 ft.), 4300, 4500, 4700, 4900. Caster wheels on 4300., For Case IH Soil Finishers, Fits Models 4200, 4400, 4450, And For Case IH Ripper Transport Wheels on 690m MRX690	H606468R21	89.69
465493R2	Hub With Cups	With Inner Cup LM48510, Outer Cup M12610, 6 Bolt Holes, For Case IH Disc Harrows, Fits Models 470, 475, 480, 485, 496, 501, 610, 760, 770	H465493R2	86.89

TILLAGE - DISC REPLACEMENT PARTS

JOHN DEERE



OEM Number	Description	Application	Order No.	List
A20621/N241315	Spool 1-7/8	Fits Models With 7-1/4" & 9" Spacing. New Style	HA241315	25.38
AN240518	Full Spool, 9" Spacing	For 1-1/4" Axle. Fits 310, 315, 330, 331, 335, 360, 375, 635, 640, 850, 870 DISCS 637 DISC	HAN240518	111.84
AA29843		WITH C Spring Bearing Hanger. Fits 510 and 512 Disc Rippers and 1710, 1710A Mulch Tillers		
AA29842	Full Spool, 11" spacing	For 1-1/4" Axle, Fits 315, 335, 355, 375, 640, 650, 670 discs. 637 disc with C spring bearing hanger.	HAN260397	128.78
AN260397		510 and 512 disc rippers.		
N240970	Half Spool, 2-1/2"	For 1-1/4" Square Axle and models with 9" or 11" Spacing, Fits Models 310, 315, 330, 331, 335, 340, 350, 355, 360, 375, 635, 640, 650, 670 discs. 637 disc with C spring bearing hanger. 510 and 512 disc rippers. 1710, 1710A mulch tiller.	HN240970	54.20
B34211	Half Spool, 5"	For 1-1/4" Axle and 9" Spacing, Fits Models 310, 315, 330, 331, 335, 340, 350, 355, 360, 375, 635, 640, 650, 670 and 637 disc with C spring bearing hanger. Also Fits John Deere Mulch Tiller 1710, 1710A	HB34211	57.30
B34212	Half Spool, 7"	For 1-1/4" Axle and Models with 11" Spacing. Fits 310, 315, 330, 331, 335, 340, 350, 355, 360, 375, 640, 650, 670 discs. 637 disc with C spring bearing hanger. 510 and 512 disc rippers.	HN241234	65.82
N241234		1700 mulch tiller.		
AN183629	Double Spool	Fits Models With 9" Spacing. Heavy Duty	HAN183629	81.76
N242189	Scraper Spring	For HAP38364	HN242189	7.44
AN240886	Scraper Arm RH	Fits 630, 640, 215, 235, 627, 635, 637	HAN240886	50.82
AN240887	Scraper Arm LH	Fits 630, 640, 215, 235, 627, 635, 637	HAN240887	45.62
N242551	Scraper Blade	For Disc Harrows, Fits Models 215, 235, 627, 630, 635, 637, 2620, 2623, 2625, 722, 2310 mulch finishers	HN242551	9.47
A38364				
AA28184	Disc Gang Bearing Only.	Fits Models 210, 215, 220, 230, 235, 621, 630, 635 & 637	HAA28184	34.65
A34792	Flange W/O Zerk	Fits Models 210, 215, 220, 230, 235, 621, 630, 635 & 637	HA34792	8.05
AA27172	Flange W/ Zerk	Fits Models 210, 215, 220, 230, 235, 621, 630, 635 & 637	HAA27172	8.31
AA30942	Disc Gang Bearing Kit	Fits Models 310, 315, 330, 331, 335, 340, 350, 355, 360, 370, 637, 640, 650, 670, 512 Ripper.	HA30942	72.02
B34203	Sleeve, 8-3/4" Long	For Models With 9" Spacing. Fits 310, 315, 330, 331, 335, 340, 350, 355, 360, 370, 375, 635, 640, 650, 670, and 637 disc with C spring bearing hanger. Mulch Tiller Models	HB34203	18.35
B34204	Sleeve, 10-3/4" Long	For Disc Harrow Models With 11" spacing. Fits 310, 315, 330, 331, 335, 340, 350, 355, , 360, 370, 375, 635, 640, 650, 670, and 637 disc with C spring bearing hanger.	HB34204	19.80
A37024/N241320	End Washer	Fits Disc Rippers 510 and 512. Fits 1700 Mulch Tiller	HN241320	20.25
34103	Washer	Slack, 1-1/8" square hole, 1/4" thick. Plated	H34103	7.44
AB12603	DBL Taper Roller Bearing Kit	1-1/4" Square Bore, with 2 Races & 2 Seals. Fits AWR,BF,BFT,BWA,BWS. Also fits Case IH & Kewanee discs.	H501334	94.64
JD8327, B31312				
AA0941, 822-207C	Gang Bearing Kit	(1) Bearing, (1)Flange W/ Zerk, (1) Gasket, 4 Bolt, Nuts & Washers. For 1-1/8" square axle.	HAA30941	54.38
FC2286, FD209R1-3/4" Kit		Fits 210, 215, 230, 235, 621, 630, 635, 637 Disc. Also fits Great Plains Disc Models 1000TT, 1200TT,1700TT, 2200TT, 3300TT,4000TT		
AA30942	Gang Bearing Kit	(1) Bearing, (1)Flange W/ Zerk, (1) Gasket, 4 Bolt, Nuts & Washers. For Rear 637 Disc, 310, 315, 330, 331, 335,340, 350, 355, 360, 370, 637, 640, 650, 670, 512 Ripper. For 1-1/4" Axle	HAA30942	71.50
N241202	U Bolt	For Gang Standard 630-637	HN241202	14.07
N240015	Hook Bolt, 1-2" Thread	For Gang Standard, Fits Models 630, 637, 650 Disc	HN240015	4.86
	Lock Plate	Fits all Case IH and John Deere 1-1/8" square Gang Bolt	H34101	1.51

SUNFLOWER



HSN3090



HSN3091



HSN4924



HSN3094



HSN9691



HSN2816



HSN3108



HSN5980

OEM Number	Description	Application	Order No.	List
SN3060 140477	Trunion Bearing Assembly	1-3/4" Round, fit Models 1130, 1211, 1212, 1231, 1232, 1233, 1234, 1321, 1331, 1431, 1432, 1433, 1434, 1435, 1441, 1442, 1443, 1444, 1541, 1543, 1544, 1550, 4306, 6630, 6631. Disc Rippers 4310, 4311, 4410, 4411, 4511. Coulter Chisels 4211, 4212, 4213, 4232, 4233. Soil Conditioners 7211, 7212, 7213, 7232, 7251, 7252	HSN3090	150.27
DC211TTR21	Disc Bearing	1-3/4" Round Bore	HSN3091	39.87
SN4924	Shield	For Trunion Bearing Assembly. Also Special Washer for GW211PP27 Bearing	HSN4924	4.30
SN3094	Snap Ring	For Sunflowe Trunion Assembly, Amco 17032 Housing, and W&A Hipper 203715 Housing	HSN3094	3.29
SN9691	Trunion Mount	For Trunion Bearing Assembly P3090	HSN9691	20.25
SN2816	Spool	Depth, 2-3/8" for Sunflowe Discs with 7-1/2" or 8-1/2" spacing. Fits models 1130, 1211, 1212, 1231, 1232, 1233, 1234, 1321, 1331, 1431, 1432, 1433, 1434, 1435, 1441, 1442, 1443, 1444, 1541, 1543, 1544, 1550, 6630, 6631. Fits Sunflowe Land Finishers with riveted flang bearings.	H2816	37.00
SN3108	Spool	4-1/8" depth, For Sunflowe Disc Models with 8-1/2" spacing. Fits Models 1211, 1212, 1231, 1232, 1233, 1234, 1321, 1331, 1431, 1432, 1433, 1434, 1435, 1441, 1443, 1444, 1541, 1543, 1544, 1550	HSN3108	42.75
SN5980	Spool - Full	For 8-1/2" spacing and 1-3/4" round axle, fit Sunflowe Disc models 1211 to 1544, 4308,4310, Soil conditioner models 7212 to 7252, Hipper models 4311-4511	HSN5980	83.18

JOHN DEERE 1-1/8" SQUARE AXLES

CASE - INTERNATIONAL 1-1/8"



Description	OEM No.	Order No.	List
1-1/8" SQ 50.7" DISC AXLE	A20133	HA20133	105.08
1-1/8" SQ 59.7 DISC AXLE	A20134	HA10134	123.01
1-1/8" SQ 68.7" DISC AXLE	A20615	HA20615	140.08
1-1/8" SQ 77.7" DISC AXLE	A20616	HA20616	160.09
1-1/8" SQ 87" DISC AXLE	A20617	HA50617	176.85
1-1/8" SQ 95.7" DISC AXLE	A40826	HA40826	143.14
AXLE NUT 1-1/8"	220089	N83-0118	2.82

Description	OEM No.	Order No.	List
1-1/8" SQ 40.14" DISC AXLE	468607	HA468607	82.01
1-1/8" SQ 49" DISC AXLE	471014R1	H47101HR1	110.21
1-1/8" SQ 57.6" DISC AXLE	471015R1	H471015R1	110.21
1-1/8" SQ 67.4" DISC AXLE	652939R2	H652939R2	125.58
1-1/8" SQ 71.9" DISC AXLE	472586R2	H472586R2	138.40
1-1/8" SQ 76.4" DISC AXLE	468582R2	H468582R2	151.51
1-1/8" SQ 79.4" DISC AXLE	46883R2	H46883R2	151.22
1-1/8" SQ 85.5" DISC AXLE	481844R1	H481844R1	160.09
AXLE LOCK	P34101	HP34101	1.51
AXLE NUT 1-1/8"	220089	N83-0118	2.82

BEARINGS



Water pump type, short shank w/ groove. JD, MF & Noble. Also fits Great Plains, Lilliston/Melroe, Tye, & United Farm Tool Grain Drills. Replaces AN131668, 446612M1, 369851 and 885154B.

Order Number	List
B15-0901	12.56



Water pump type, double end - smooth. Noble and early model Glencoe Cultivator. Also fits Crustbuster, Tye, Great Plains, & United Farm Tool Grain Drills. Replaces 601440F1, P6310 and 885118B.

Order Number	List
B15-0903	16.45

Water pump type, short shank w/hole. JD 7000, 7100, 7200, 7300 Planters for both gauge wheel & closing wheel. Also fits row marker disc assembly. Replaces AA21015, AA35741, GA2022 and 885152. White 5100, 5700 Series Gauge Wheels.

Order Number	List
B15-0902	11.70

CLOSING WHEEL ASSEMBLY

Nylon. Agco-White Planters. 1"x12". JD 7000, 7100, MaxEmerge™, Kinze prior to 1993 with bearing. Replaces AA33297, GA3086, 017630 and AA43899



Order Number	List
W29-0160	76.06

CLOSING WHEELS

JD 1700 planter, 1530 & 1535 drills, Kinzie planter 93 & Newer with bearing. 1"x12". Replaces AA39968 and GA6434



Order Number	List
W26-0166	83.45

JD 1700 Series, 7200, 7240, 7300, 7340 MaxEmerge2 planters, 1520, 455, 750 drill. with bearing. 1"x12". .669 axle diam. Replaces AA43898 and AA34211.

Order Number	List
W26-0167	53.57

GAUGE WHEEL ASSEMBLIES

Replaces Number	Application	Order Number	List
AA32046	Painted Yellow for JD 7000,7100,7200 & 7300 Series Planters.	W29-0158	187.65
AA35392	4.5" x 15". With hole in bearing stem.		

TIRES



W29-0159

Replaces Number	Application	Order Number	List
A22884	Tire only for Gauge Wheel for JD 7000,7100,7200,7300 Series Planters, also fits Kinzie, Agco-White, fits W29-0158 & W29-0161 Assembly. 4.5"x15"	W29-0162	72.58
GD1086			
247812B			
AA22325	Tire only for closing wheel on JD, Kinzie and Agco-White Planters.	W29-0159	10.16
GD1085	Fits W29-0160 Assembly. 1" x 12".		
017632			

8" COVERING DISC FOR CASE-IH & NEW HOLLAND

Fits Case-IH Planters, all 900, 950, 955 and 1200 series; 5400, 5500 Soybean Special; New Holland SP280, SP380 & SP580. Includes blade, bearing retainer, rivets and dust cap. Replaces 1277891C91.



Order No.	List
H1277891C91	34.82

JOHN DEERE AND KINZIE PLANTER SEED DISC OPENERS

Made In The USA. High Quality Boron Steel. Includes Hub & Bearing, Order Dust Cap Separately(Listed Below)



Heavy Duty Seed Opener Assembly. 3.5MM thick, 15" Diameter

Application	Replaces	Order No	List
John Deere 7000, 7100 Max Emerge, 7200, 7330, and 1700 Series Planters. Kinzie Planters except 3000 series. Double row bearing.	AA65248	HAA65248	48.75



BEARING
7/8" hex bore. Has curved O.D. used on seed and fertilizer drives. Replaces JD no. AA22097.

Order No: HAA22097 **15.81**



BEARING
7/8" hex bore. Has fla O.D. Replaces JD no. AA28271.

Order No: HAA28271 **9.99**

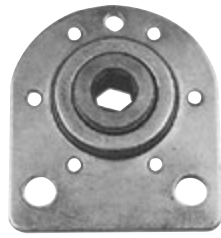

BEARING
For clutch actuator shaft. 9/16" hex bore. Fits 7000 fle fold, 7200 & 1750. Replaces JD no. AA34259.

Order No: HAA34259 **17.87**



BEARING
Closing wheel bearing for John Deere Model 7200, 7300 and IHC mode 296 & 386 planter, Bore Size: 0.669" round, O.D: 1.574" flat IR width: 0.55", OR width : 0.472".

Order No: HAA35638 **12.56**



BEARING
Bearing with cross hole to fit gauge wheel assemblies. Has a 40 mm O.D. to eliminate the use of the bearing spacer.

Order No: HAA35951B **14.84**



BEARING
Double row ball bearing with 5/8" ID for closing & gauge wheel. Double Row Angular Contact Planter Bearing.

Order No: HAN21213211.15



BEARING
Ball bearing, ID: 15mm (.59"), OD: 42mm (1.65"), Width: 22mm (.87")

Order No: HCJ13975 **7.58**



BEARING/SPROCKET
Bearing with 19 tooth sprocket, 7/8" hex bore, 1-1/2" width. Used on John Deere 7200, 7300 and 1700 series planters row unit and planter drive line.

Order No: HAH133868 **40.17**



BEARING/SPROCKET
Planter Drive Sprocket - 9/16" hex. Fits 700, 7100, Max Emerge, 7100 Soybean Special.

Order No: HAA30654 **28.05**



BEARING/SPROCKET
Sprocket and bearing with standard for row unit. 19 tooth fit 7300 JD 7200 and 1700 series planters. Replaces JD no. AA35645. Hub width is 3.25"

Order No: HAA35645 **28.05**



BUSHING
For closing wheel arm. Replaces H2204B.

Order No: HA2204 **3.58**



BUSHING
For closing wheel arm. 2 Required. Fits MaxEmerge Plus, Pro, XP Pro, 1530 and 1535. Replaces A55888.

Order No: HA55888 **7.72**



BUSHING
Fits John Deere 1700, 1760, 1780, 7200, 7300, MaxEmerge 2, 120XP, Plus, Pro. Replaces A48515.

Order No: HA48515 **3.61**



BUSHING
For Parallel arms on John Deere 7000 - 7100; Kinze 2000 Series. Replaces A23789 and GB0218

Order No: HA23789 **1.76**



BUSHING
Self-aligning bushing. Fits 1700, 1710, 1720 Series Planters and attachments. Replaces AA57058.

Order No: HAA57058 **7.83**



BUSHING

Cam bushing, left hand. For closing wheel arm. Fits 7300 Series MaxEmerge 2 Planters. Replaces A48290.

Order No: HA48290 **4.09**



BUSHING

Cam bushing, right hand. For closing wheel arm. Fits 7300 Series MaxEmerge 2 Planters. Replaces A48430.

Order No: HA48430 **6.57**



CLOSING WHEEL ARM

Cast closing wheel arm for John Deere Max Emerge Plus, PRO, XP PRO, 1530, 1535 series.

Order No: HA86763 **61.11**



CLOSING WHEEL ARM

Closing wheel arm for John Deere 7000, 7100. Replaces JD no. AA31217. Can be used to replace Kinze GA6056.

Order No: HAA31217 **44.49**



CLOSING WHEEL ARM

Closing wheel arm for John Deere 1760, 1780, 7200, 7300, 7340 planters. Replace JD numbers AA37552 & AA37839. Comes with spindles for wheels.

Order No: HAA37552 **51.83**



CLOSING WHEEL ARM STOP

Cast iron closing wheel arm stop, painted green. Fits 7000, 7100; Kinze (except 3000 series). Replaces JD No A28135, A33879; Kinze No GB0113.

Order No: HA33879 **36.11**



DUST CAP

Dust Cap for seed bearing housing. 1-1/2" diameter. Used on AA55927, AA37474

Order No: HA52024 **1.16**



DUST CAP

Dust cap for seed disc opener, smaller cap diameter 1-1/4".

Order No: HAG78218 **1.21**



GAUGE WHEEL ASSEMBLY

Nylon/steel wheel halves & 5203KYY2 bearing.

Order No: HA66604 **119.72**



GAUGE WHEEL ARM KIT

Has threaded bushing for proper adjustment of the gauge wheel to the seed disc opener. Updates older planters to the new style arm design. Comes with two different threaded bushing, one for older series of planters and one for the newer series. Fits models JD 7100, 7200, 7300 & Max Emerge 1760, 1780, 1700, 1710, 1721 series Planters. Replaces AA41968, AA54179.

Order No: H25502B **61.65**



GAUGE WHEEL ARM KIT

Fits 7000 thru early 1700, 1710, 1720 plus. Kit includes threaded bushing, arm and hardware. Replaces AA41968. Wheel mounts with set screw.

Order No: HAA41968 **63.84**



GAUGE WHEEL ARM KIT

Fits 1720 XP Series. Includes threaded bushing and mounting hardware. Replaces AA79648. Wheel mounts with hex bolt.

Order No: HA79648 **56.41**



GAUGE WHEEL HALF

Nylon gauge wheel half. Fits John Deere planters and drills with nylon/steel wheel half combination gauge wheels. XP and XP Pro planters; 1560, 1590, 1690, 1835, 1860, 1890, 1895 and 1990 grain drills. Fits Case-IH New Holland planters with nylon/steel wheel half combination gauge wheels.

Order No: HA56565 **40.17**



HANDLE

Handle for closing wheel arm on John Deere Max Emerge® 2, Plus, Pro, and XP row units. Replaces JD number A64237.

Order No: HA64237 **8.82**



HUB

Fertilizer Hub for JD Double Disc Openers Fertilizer unit. Cast hub without bearing.

Order No: HAWFHUB **21.08**



OPENER GUARD

Fits 7200 and newer planters. Replaces JD no. A48879. Fits 7200, 7330, Max Emerge 2, 1760, 1780, Max Emerge Plus, XP.

Order No: HA48879 **10.09**



PIVOT STOP KIT

Fits MaxEmerge Plus, Pro, XP, XP Pro, 1530, 1535, also late MaxEmerge, including: A82772 John Deere XP planter stop, A62609 John Deere XP planter rocker, A58670 John Deere XP planter pivot bolt.

Order No: HA62609K **37.91**



ROCKER

For walking gauge wheel. 3/4" pivot hole and built-in pivot stops. Fits MaxEmerge®Plus, Pro, XP Pro, 1530, 1535. OEM No.:A62609

Order No: HA62609 **49.40**



SCRAPER

Inside fertilizer scraper for double disc openers. One used per row.

Order No: HAB35913 **3.55**



SCRAPER ASSEMBLY - LEFT

Fits John Deere 7000, 7100 MaxEmerge; 7200, 7300 and 1700 Planter with MaxEmerge 2 and MaxEmerge Plus Row Units; Kinze. Replaces AA26444 and GA2012L.

Order No: HAA26444L **6.75**



SCRAPER ASSEMBLY - RIGHT

Fits John Deere 7000, 7100 MaxEmerge; 7200, 7300 and 1700 Planter with MaxEmerge 2 and MaxEmerge Plus Row Units; Kinze. Replaces AA26443 and GA2012L.

Order No: HAA26443R **6.75**



SCRAPER

Heavy duty seed blade scraper for planter parts, model 7200, 7300, 1760, 1780. For use in sticky soils.

Order No: HA62182 **6.96**



SCRAPER KIT

Fits John Deere Planter 1705 thru 1795, DB44 thru DB120. Replaces OEM # A98183, A98182. Includes LH Scraper, RH Scraper and Tension Spring.

Order No: H98180K **16.86**



SCRAPER KIT

Tungsten carbide edge. Fits John Deere 1530, 1535, 1700, 1720, 1730, 1760, 1789, 1790, 7100, 7200, 7300, 7340. Kit includes 1 LH and 1 RH Scraper, 1 spring and 2 hairclips. Replaces AA62808.

Order No: HAA62808 **43.31**



SCRAPER KIT

Fits John Deere 1530, 1535, 1700, 1720, 1730, 1760, 1789, 1790, 7100, 7200, 7300, 7340. Kit includes 1 LH (nylon covered), 1 RH Scraper Arm, 1 Spring, 2 Cotter Pins. Replaces BA28945.

Order No: HAA37221K **19.51**
Rotating Scraper Wheel Only
HAA37221 4.25



SCRAPER WHEEL

Fits John Deere 7000, 7100, 7300, 7340, MaxEmerge 2, Pro, Plus, XP and XP Pro.; White Planters 5100, 5700, 6000 and 8000. Replaces AH133315.

Order No: HAH133315 **4.86**



SEED GUARD

Fits John Deere 1760, 1780 (before 2/97); 7000, 7100, 7200. Replaces A41692.

Order No: HA41692 **10.13**



SEED GUARD

Fits John Deere 1700 Series Planters and Attachments. For use with curved seed tube, bracket welded to seed guard. Replaces P61577.

Order No: HA61577 **14.78**



SEED TUBE CLIP

For JD 1785 & 1985 XP. Will replace JD A55984, AP00178 clip.

Order No: HA55984 **1.40**



SEED TUBE PROTECTOR

For XP row units

Order No: HA80203 **11.76**



SPACER

Fits models John Deere 7200, 7300, 7240, 1760, 1780, 1700 XP series.

Order No: HA43610 **4.93**



SPACER

For closing wheel arm. 2 per arm. Replaces A52556. Fits 7200, 7300, Max Emerge 2, 1760, 1780 and Max Emerge Plus.

Order No: HA52556 **2.90**



SPRING

Idler arm spring. Replaces John Deere no.'s A28518, A63534 and Kinze GD1065. Used on 7000, 7200, and 1700 series.

Order No: HA28518 **2.27**



SPRING

Tension left hand spring for heavy duty scraper, for John Deere 1700 series planter units and attachments.

Order No: HA41116 **2.54**



SPRING

Standard down pressure spring for John Deere planters. Bolts to side of parallel arms. Two or four used per row. Replaces JD no. A43609. Used on Max Emerge & Max Emerge Plus.

Order No: HA43609 **17.91**



SPRING

Idler arm spring for Herbicide/Insecticide drive. Replaces JD no. A49644. Used on 1700, 7200 and 7300 series.

Order No: HA49644 **2.35**



SPRING

Closing wheel spring for John Deere Model 1760, 1780 7200, 7300 MaxEmerge 2 and 7340. Coiled part is 3 3/4", overall length is 7".

Order No: HA74643 **20.69**



SPRING

Heavy duty down pressure spring with plug. Replaces JD no.'s AA28046 and AA35876; Kinze no GA2068. Also used on Kinze contact drive wheels.

Order No: HAA35876 **25.38**



SPRING

Down pressure spring with plug. Fits John Deere 7000, 7100 series Planters; Kinze. Replaces AB10071 and GA2052.

Order No: HAB10071 **12.58**



SPRING

Closing Wheel spring with plug. Fits John Deere 7000, 7100 series Planters; Kinze. Replaces A23116 and GA2054.

Order No: HA23116 **16.66**



SPROCKET

14 tooth idler sprocket for 40 chain. Fits seed transmission on John Deere planters 7200, 7300 and 1700 series; dry fertilizer transmission on 7200, 7240, 1750, 1770, 1780, 7000 Flex-Fold.

Order No: HAA32729 **19.14**



SPROCKET

Fits 1700 Series Planters and attachments. Finger pickup and vacuum meter drive. Plateless herbicide and insecticide drive. Replaces A55008.

Order No: HA55008 **1.47**



SUPPORT

Support, seed guard, replace A54868. Fits 7200, 7300 Max Emerge 2, 1760, 1780, Max Emerge Plus, 700, 7100, Pro Series.

Order No: HA54868 **9.66**



TIRE

4.5" x 16" tire with standard profil offset. Fits John Deere planters XP, XP Pro row units; 1530, 1535 with XP.

Order No: HA84062 **54.82**



CLOSING WHEEL ASSEMBLY

Nylon. Agco-White Planters. 1"x12". JD 7000, 7100, MaxEmerge™, Kinze prior to 1993 with bearing. Replaces AA33297, GA3086, 017630 and AA43899

Order No: W29-0160 **76.06**



CLOSING WHEEL

JD 1700 planter, 1530 & 1535 drills, Kinzie planter 93 & Newer with bearing. 1"x12". Replaces AA39968 and GA6434

Order No: W29-0166 **83.45**



CLOSING WHEEL

JD 1700 Series, 7200, 7240, 7300, 7340 MaxEmerge2 planters, 1520, 455, 750 drill. with bearing. 1"x12". .669 axle diam. Replaces AA43898 and AA34211.

Order No: W29-0167 **53.57**

KINZE PLANTER PARTS



BUSHING

Eccentric bushing for GA8322 Arm, heat treated. Zinc plated.

Order No: HGB0239 **4.86**



BUSHING

Hex stepped bushing for G8322 arm, heat treated.

Order No: HGB0282 **4.25**

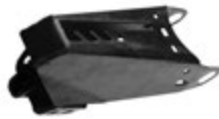

CLOSING WHEEL ARM

Closing wheel arm for Kinze built 1993 and later. For use with bolt on wheels. Replaces Kinze GA8322.

Order No: HGA8322 **46.42**



GAUGE WHEEL ARM

Planter gauge wheel arm for Kinze. Has thread hole at the bottom to attach the gauge wheel. Has threaded bushing at the top for adjusting the gauge wheel to the seed disc opener.

Order No: HGA6614 **32.88**

GAUGE WHEEL ARM

Gauge wheel arm. Right hand. Replaces Kinze GA7976, fit Kinze 3000 series.

Order No: HGA7976 **46.04**



LEVER

Closing wheel adjusting lever; Kinze 1993 and newer.

Order No: HGB0254 **6.78**



SPRING

New style down pressure spring for quick adjust. Fits Kinze only.

Order No: HGD8429 **7.67**



PLANTER TALC AND GRAPHITE

TALC POWDER

- Maximizes yield and profit by increasing plant population per acre.
- Reduces moisture generated by vacuum planters.
- Helps prevent "bridging" of seeds in planter by reducing moisture.
- Helps seed flow smoothly and evenly through vacuum meter planters.
- Reduces wear on vacuum meter components.

Size	Order No.	List
8 lb Jug	A 735300	32.91
20 lb Box	A 735301	45.44



GRAPHITE POWDER

- Maximizes yield and profit by increasing plant population per acre.
- Easiest, most convenient way to apply seed-flow lubricant. No buildup.
- Helps prevent "bridging" of seeds in the planter.
- Helps seed flow smoothly and evenly through high-speed planters.
- Reduces wear on planter plates.

Size	Order No.	List
1 lb Bottle	A 735304	9.38
5 lb Jug	A 735303	28.11



80/20 TALC GRAPHITE

- Designed exclusively for treated seed.
- Increases planting efficiency and maximizes yield per acre.
- Use in both "gravity flow" and "air" planters.
- Reduces moisture issues, lubricates seed and equipment.
- Helps prevent "seed bridging" in the planter.
- High-purity for less meter wear.
- Non-toxic
- Apply 4-6 oz each time hopper is filled with seed.

Size	Order No.	List
8 lb Jug	A 735307	47.56
20 lb Box	A 735308	52.49



EZ-MEASURE FLIP LID

New lid allows application with minimal human or wind exposure and gives precise amount measurements. Measures in 1/8 cup increments. Fits 8 lb jugs.



Order No: A 735312 **18.46**



ROW CROP CULTIVATOR SWEEPS

- Punched with three holes - two on 2" centers for 7/16" x 1-3/4" bolts and the center hole is square for a 5/8" x 1-3/4" carriage bolt.
- 54 degree shank angle.

- The wings have been flattened and the crown lowered which allow for higher speeds and less dirt being pushed on the crops.
- Used on the Allis Chalmers, the Forrest City Du-All, Buffalo No-Till cultivator, Case, Cockshutt 237, 239, 337, and Minntoba LDC.
- 3/16" thickness.
- Uses 7/16 x 1-3/4" #3 Plow Bolt.

Made In The USA

Size	Description	Order No.	List
4"	Plain, Full	22404	10.31
6"	Plain Full	22406	11.29
8"	Plain	22408	12.27
10"	Plain	22410	13.02
10"	Hardfaced Bottom Side, Full	22410H	59.55
12"	Plain, Full	22412	16.33
14"	Full	22414	26.75
16"	Full	22416	29.44
18"	Plain, Full	22418	35.47
20"	Plain, Full	22420	36.49
22"	Plain, Full	22422	44.64
24"	Plain, Full	22424	48.64

Made In The USA



- 1/4" Thick
- Constant Width Wings
- Heat Treated Boron Steel

FIELD CULTIVATOR SWEEPS

924 Series will fit Bourgault, Crustbuster, DMI, Harris, Hesston, Hinker, IHC Vibra Shank, Ingham, John Deere 960 Series, Kent, Kewanee, Landoll, Massey Ferguson, Sunflower and Wilrich. **Requires 7/16" no. 3 head bolts. 1-3/4" hole spacing. 1/4" thick. 47° Stem angle.**

934 Series will fit Anderson, Bush Hog, CCIL 179, 379 and Z, Case FC, FCM and FCSW, Cockshutt 285 and 485, Ford 208, Glencoe 101, Kewanee, Krause 600 and 900, Leon Vibro Flex Massey Ferguson 160, Minneapolis Moline FT 200, Morris L240 and L320, Oliver 285, 385 and 485, Taylor, and White. **Requires 3/8" x 1-1/4" no. 3 head bolts. 1-3/4" hole spacing. 1/4" thick. 47° Stem angle.**

944 Series will fit Allis (early models), Baker, Brady (prior to 70-71), Brillion (prior to 1986), Cockshutt (early models), Deere (CCA, CC10, CC20, and 1000 Series, Glencoe (1250 double shank), Krause (k-tine), and Oliver (245 and 345). **Requires 3/8" x 1-1/4" no. 3 head bolts. 1-5/8" to 1-3/4" hole spacing. 1/4" thick. 41° Stem angle.**

924 SERIES - 47° STEM ANGLE

Size	Description	Order No	List
4"	Plain	92404	12.96
6"	Plain	92406	13.07
7"	Plain	92407	14.04
7"	Hardfaced Top Side	92407H	35.87
8"	Plain	92408	14.60
9"	Plain	92409	14.81
9"	Hardfaced Top Side	92409H	35.62
10"	Plain	92410	16.56
10"	Hardfaced Top Side	92410H	37.85
11"	Plain	92411	17.08
11"	Hardfaced Top Side	92411H	39.87
12"	Plain	92412	17.62

934 SERIES - 47° STEM ANGLE

Size	Description	Order No	List
4"	Plain, Slotted Hole	93404S	13.02
6"	Plain	93406	13.07
7"	Plain	93407	14.04
9"	Plain	93409	14.81
10"	Plain	93410	16.56

944 SERIES - 41° STEM ANGLE

Size	Description	Order No	List
6"	Plain	94406	13.07
7"	Plain	94407	14.04
9"	Plain	94409	14.81

FIELD CULTIVATOR SWEEPS

- Popular Long Wearing design
- Dimple to protect premature bolt wear
- Extended Nose for longer wear and better penetration
- Constant Width Wings-will cut same width from new until worn out
- Quality Boron Steel heat treated for long life
- Knock on sweeps fit Nichols style clips only
- Available in both 1/4" & 5/16" thick

ORDER NO	DESCRIPTION	THICKNESS	CRATE QTY	LIST
KNOCK-ON				
S85-0707	7" N SERIES KNOCK ON SWEEP	1/4"	800	16.96
S85-0807	7" N SERIES KNOCK ON SWEEP	5/16"	800	19.80
S85-0709	9" N SERIES KNOCK ON SWEEP	1/4"	750	17.77
S85-0809	9" N SERIES KNOCK ON SWEEP	5/16"	750	20.97
S85-0810	10" N SERIES KNOCK ON SWEEP	5/16"	500	21.65

ORDER NO	DESCRIPTION	THICKNESS	CRATE QTY	LIST
BOLT-ON				
S85-1707	7" N SERIES BOLT ON SWEEP	1/4"	800	16.96
S85-1807	7" N SERIES BOLT ON SWEEP	5/16"	800	19.80
S85-1709	9" N SERIES BOLT ON SWEEP	1/4"	750	17.77
S85-1809	9" N SERIES BOLT ON SWEEP	5/16"	750	20.97
S85-1810	10" N SERIES BOLT ON SWEEP	5/16"	500	21.65

HARDWARE

C45-0615	Clip, Heavy Duty Forged. 1-5/8" - 2" Spacing. 47 deg	4.05
C45-0608	Clip 2" Spacing 47 deg	4.60
C45-0607	Clip 1-3/4 Spacing 47 deg	4.60
C45-0610	Retainer Spring. Ensures sweep does not fall off clip. Not required.	2.60





FURROWERS - 600 SERIES

All 600 Series Furrowers are punched with 3 holes. Two holes for 7/16" plow bolts on 2-1/4" centers and one square hole, centered for 5/8" carriage bolt. Made from 1080 High Carbon Steel. Heat Treated for Longer Wear.

Material Thickness	Bolt Size	Hole Spacing
1/4"	2) 7/16" Plow Bolts or 1) 5/8" Carriage Bolt	2-1/4"

Size	Width		Description	Order No	List
	Bottom	Top			
6"	6"	9.25"	Plain	608	28.60
6"	6"	9.25"	Hardfaced	608H	39.72
8"	8"	9.5"	Plain	610A	28.60
8"	8"	9.5"	Hardfaced	610H	49.65
10"	10"	14"	Plain	612	36.60
10"	10"	14"	Hardfaced	612H	58.24
12"	12"	15"	Plain	615	44.74
12"	12"	15"	Hardfaced	615H	63.51
15"	15"	20"	Plain	618	65.27
15"	15"	20"	Hardfaced	618H	89.07



FURROWERS - LISTER SHARES

All Lister Style Furrowers are punched with 1 square hole, centered for 3/4" carriage bolt. Made from 1080 High Carbon Steel. Heat Treated for Longer Wear.

Material Thickness	Bolt Size	Hole Spacing
1/4"	3/4"	Centered

Size	Description	Order No	List
14"	Plain	1014	60.78

TERMINATOR II SWEEPS

1/4" thickness. 47 degree stem. 7/16" bolt size. 1-3/4" hole spacing. Contoured wings provide better soil disturbance across entire sweep for improved weed control. Extended sweep point improves soil penetration. Hammer-lock sweeps use clips listed below.



Made In The USA

Size	Description	Order No.	List
7"	Bolt-On	S85-0515	18.20
7"	Hammer-Lock	S85-0537	17.65
9"	Bolt-On	S85-0516	19.14
9"	Hammer-Lock	S85-0539	18.81
10"	Bolt-On	S85-0517	19.69
10"	Hammer-Lock	S85-0540	19.61

- Sweep point is 5/8" longer than Terminator I Sweeps for improved soil penetration.
- Contoured wings are 7/16" wider than Terminator I Sweeps which results in better soil action.
- Clipped style wings maintain full cutting width and prolonged sweep life.
- Hammer-Lock design eliminates unbolting and rebolting.
- Accurately fits Empire and McKay mounting clips.

HAMMER-LOCK SWEEP

Constant Width. 49 degree stem angle. 1/4" Thickness. Use clips listed below.

Made In The USA

Size	Description	Order No.	List
4"	Plain	S85-0404	16.49
7"	Plain	S85-0405	18.13
9"	Plain	S85-0406	20.06
10"	Plain	S85-0407	23.83



HAMMER-LOCK SWEEP

Constant Width. 41 degree stem angle. 1/4" Thickness. Use clips listed above right.

Made In The USA

Size	Description	Order No.	List
7"	Plain	S85-0411	18.13



MOUNTING CLIP FOR HAMMER-LOCK SWEEPS

Made In The USA

Install clip only once when using hammer-lock designed sweeps.

Replaces No.	Bolt Size	Hole Spacing	Order No.	List
LKM-7	7/16"	1-3/4" - 2" Slotted	C45-0408	5.11
		Safety Spring	C45-0510	2.87



C45-0510

SLIM SHANK SPOONS & SWEEPS

Designed to leave field smoother. For use on Air Seeders and Field Cultivators. Full width clipped wings.

Size	Description	Order No	List
2"	Seeder Spoon	S85-0522	10.42



JOYCE SWEEPS

Used Primarily in California and Arizona for Cultivation of Cotton and Potatoes. Higher Crown and Wing Lift for Greater Soil Disturbance than the 224 Series Sweeps. 55 degree stem angle. Punched with three holes

- two on 2-1/4" centers for 7/16" x 1-3/4" bolts and the center hole is square for a 5/8" x 1-3/4" carriage bolt.

Made In The USA

Size	Full, Right, or Left	Order No.	List
8"	Plain, Full	44408	16.82
10"	Plain, Full	44410	18.81
12"	Plain, Full	44412	21.25
14"	Plain, Full	44414	26.49
16"	Plain, Full	44416	32.16
18"	Plain, Full	44418	39.07

PEANUT BLADES

Fits KMC (03-081-068), Lilliston and Others. Sold in pairs (1 Left, 1 Right). Requires 3/8" #3 Plow Bolts.



ADAMS DESIGN ADAMS QUALITY

- Made From Boron Steel
- Heat-Treated To Increase Wear
- Oil Quenched
- Painted Green

Length	Thickness	# Of Bolts	Order No	List
42"	3/8"	3	PNB	140.45

WING SWEEPS - V-PLOW BLADES

5/16" Thick. 1/2" X 1-1/2" #3 Bolt. 75 degree angle. Eagle Beak, Chrome Alloy Point. Rod Hard-Faced. Clipped Wing. **Made In The USA!**



Fits Noble, Krause, Flex King, TriFlex, ARK Valley, Sunflower, Richardson, Bush Hog, John Deere, Hayhawk, Vasser, Davies and Miller.

Size	Description	Order No	List
5'	Hard-Faced Bottom Side, Inserted	05HBSCP	639.22
5'	Hard-Faced Top Side, Inserted	05HTSCP	639.22
5-1/2'	Hard-Faced Bottom Side, Inserted	055HBSCP	665.40
5-1/2'	Hard-Faced Top Side, Inserted	055HTSCP	665.40
6'	Hard-Faced Bottom Side, Inserted	06HBSCP	706.57
6'	Hard-Faced Top Side, Inserted	06HTSCP	706.57
6-1/2'	Hard-Faced Top Side, Inserted	061/2HTSCP	745.10
7'	Hard-Faced Top Side, Inserted	07HTSCP	1020.94

TILLAGE

DANISH SWEEPS

1/4" thickness. Designed to fit Danish S-Tine and other field preparation equipment of this type. Require 3/8" x 1-1/2" elliptical head bolt (H10 type). Dimple to protect bolt head. Heat-treated. **Made In Iowa.**



Description	Style	Order No	List
1-1/2" point	A	S32-0001*	3.91
2-3/4" duckfoot	B	S32-0016	6.10
4" duckfoot	C	S32-0017	6.34
4" v-design	D	S32-0018	6.34
7" sweep	E	S32-0019	9.79
9" sweep	E	1409A	10.20

*Imported

2-HOLE DANISH STYLE SWEEPS

- 5/16" Thick
- 2 Bolt Holes- 1.5" hole spacing
- Uses 7/16" Elliptical Head Bolts
- High Quality Boron Steel
- Fits Kongskilde, Unverferth and others



Description	Order No.	List
2-3/4" Duckfoot	S32-0020	5.66
4" Duckfoot	S32-0041	7.92
4" Danish	S32-0040	5.77
7" Danish	S32-0070	6.54

DANISH TINES / S-TINES

S-Tines and clamps are made to demanding OEM specifications. Tines are constructed of high quality steel with rounded edges - shot peened and painted black. For all S-Tine Danish Cultivators.

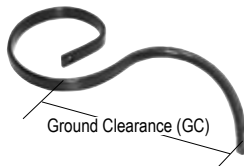

Replaces Number	GC	Size	Description	Order No	List
P5215	14.5"	3/8" x 22" x 1-1/4"	Standard	T16-0001	23.70
P5315	14.25"	1/2" x 22" x 1-1/4"	Heavy Duty	T16-0003	26.20
P5415	18"	1/2" x 26" x 1-3/4"	HD, Long	T16-0004	45.66

CLAMPS FOR DANISH TINES/S-TINES

Use 1/2" Carriage Bolts.



Size	Fits S-Tine No.	Replaces	Order No.	List
2" x 2". 1-3/8" Slot.	T16-0001, 0003	J24	C41-0004	9.69
2-1/2" x 2-1/2". 1-3/8" Slot	T16-0003, 0001	T260	C41-0011	10.21
2" x 2". 1-7/8" Slot	T16-0004	J28	C41-0028	17.99
2.5" x 2.5". 1-7/8" Slot	T16-0004		C41-0030	15.09

WHEATLAND (CHISEL PLOW) SWEEPS 22 SERIES

1/4" thickness with a 50° stem angle. Uses a 7/16" bolt. 2-1/4" hole spacing. Medium crown. Constant width.

Designed to fit Anderson, Case-High Clearance, Cockshutt, CCIL, Degelman, Frigstad, Glencoe, Graham - 600 Series, John Deere - 650, 1100, 1600, Krause, Landoll, Massey, Mel-Cam, White and Others With 22" Shanks.

Size	Description	Order No	List
12"	Plain	1222C	24.75
16"	Plain	1622C	29.27
18"	Plain	1822C*	35.83



WHEATLAND (CHISEL PLOW) SWEEPS 225G SERIES

1/4" thickness with a 47° stem angle. Uses a 1/2" bolt. 2-1/4" hole spacing. Medium crown. Constant width.

Designed to fit Anderson, Case, Glencoe, Geisler and Massey-Harris.

Size	Description	Order No	List
14"	Plain	14225GC	28.66
16"	Plain	16225GC	29.27



WHEATLAND (CHISEL PLOW) SWEEPS IH SERIES

1/4" thickness with a 43° stem angle. Uses a 1/2" bolt. 2-1/4" to 2-1/2" hole spacing. Medium crown.

Designed to fit IHC models 10, 50, 55; CCIL 203 & 204, Morris and Wilrich

Size	Description	Order No	List
10"	Plain	IH10C	22.56
12"	Plain	IH12C	24.35
14"	Plain	IH14C	25.80
16"	Plain	IH16C	27.25
18"	Plain	IH18C	32.25
18"	Hard-Faced. Bottom Side	IH18CH	57.88



CHISEL SWEEPS - CS SERIES

5/16" thickness with a 50° stem angle. 2-1/4" hole spacing.

Use in place of chisels for more soil movement.

Size	Description	Bolt Size	Order No.	List
7"	Plain	1/2"	CS505	14.67



WHEATLAND (CHISEL PLOW) SWEEPS 225 SERIES

1/4" thickness. 50 degree stem. 1/2" bolt size. 2-1/4" hole spacing. Medium crown. Constant width. Designed to fit Figstad, Graham, Hiniker, John Deere, Leon and Mohawk

Size	Description	Order No	List
12"	Plain	12225C	24.75
14"	Plain	14225C	28.66
16"	Plain	16225C	29.29
16"	Hard-Faced. Bottom Side	16225CH	54.56
18"	Plain	18225C	35.83



WHEATLAND (CHISEL PLOW) SWEEPS 505 SERIES

1/4" thickness. 50 degree stem. 1/2" bolt size. 2-1/4" hole spacing. Low crown. Constant width. Designed to fit Figstad, Graham, Hiniker, John Deere, Leon and Mohawk

Size	Description	Order No.	List
18"	Plain	18505C	35.83
18"	Hard-Faced. Bottom Side	18505CH	57.33



WHEATLAND (CHISEL PLOW) SWEEPS 516 SERIES

5/16" thickness. 50 degree stem. 1/2" bolt size. 2-1/4" hole spacing. Low crown. Standard wing. Designed to fit Quinstar Fallow Master and Sunflower Fallow King, Kent and John Deere. Reinforced wings

Size	Description	Insert	Order No.	List
26"	Plain		26516	85.54
26"	Hard-Faced. Bottom Side		26516H	96.78
26"	Hard-Faced. Top Side		26516HTS	96.78
26"	Hard-Faced. Top Side	79CC	26516H79	98.82



Standard wing.

Size	Description	Order No.	List
20"	Plain	20505	47.61
22"	Plain	22505	38.05

SPRING TOOTH SWEEPS - STS SERIES

1/4" thickness with a 31° stem angle. 3/8" bolt size. 2" hole spacing. Made from 1080 high tensile steel. Fits Bush Hog, Crustbuster and Calkins. Replaces points on spring tooth harrow and some cultivators.

Size	Description	Order No.	List
6"	Plain	STS06	7.56



WING SWEEPS

5/16" thick with 3/8" bolt hole. Designed for Hiniker and Kinzie. Will also fit other Ridge Till Cultivators with 8" hole spacing including Buffalo, Krause and Sukup. Reversible with double bevel.

Cutting	Width	Description	Order No.	List
	15"	Plain	A5115	12.41
	27"	Plain	A5127	19.18



ST11



ST14



SPRING TOOTH POINTS - ST SERIES 11" LENGTH

Plated and sharpened for better wear. Oil quenched and heat treated. Fits field cultivators, spring tooth harrows and row crop cultivators.

Width	Thickness	Bolt Size	Hole Spacing	Description	Order No.	List
2"	1/4"	3/8"	1-1/4" to 2-1/4"	Plain	ST11	12.89
2"	1/4"	7/16"	1-1/4" to 2-1/4"	Plain	ST12	12.89
2-1/2"	1/4"	3/8"	1-1/4" to 2-1/4"	Plain	ST13	8.35
1-3/4"	1/4"	3/8"	2"	Plain	ST14	12.97
2"	3/8"	3/8"	1-1/4" to 2"	Plain, Heavy Swedged Nose	ST20	10.49
2"	3/8"	7/16"		Plain, Heavy Swedged Nose	ST21	10.49

ALFALFA SPIKES

No Twist. 2-1/4" hole spacing. Reversible.

Size	Bolt	Order No.	List
3/4" x 2" x 15"	1/2"	17522	24.93
3/4" x 2" x 15"	1/2"	17522H*	62.42



17522

CHISEL POINT WITH INSERT

Chrome carbide insert. 2-1/4" x 2-1/2" Hole spacing. Uses #3-1/2" plow bolt.

Size	Bolt	Order No.	List
3/4" x 2" x 13-1/2"	1/2"	HA13S	46.27



SPRING TOOTH POINTS - CC SERIES

5/16" Thick. 11" length. 1-3/4" wide. Fits spring tooth harrows, field cultivators and row crop cultivators.

Bolt Size	Spacing	Hole Description	Order No.	List
3/8"	1-3/8" to 1-3/4"	Plain	CC01	11.56
3/8"	1-3/8" to 1-3/4"	Inserted	CC01I	30.23
7/16"	1-3/4"	Plain	CC03	11.58
7/16"	1-3/4"	Inserted	CC03I	28.69



CHISEL POINT - CB SERIES

3/4" Thick. 13" Long. 2" Wide. Will wear up to 10 times longer than plain points. Insert design directs soil flow away from bolt heads. Chromium carbide tips #61 Adalloy. Uses #3-1/2" plow bolt.

Bolt	Hole Spacing	Order No.	List
1/2"	2-1/4" to 2-1/2"	CB75	35.28

CB75



TILLAGE



CHISEL POINTS

Reversible spikes have upset (swedge) points for increased wear and longer life. Even after considerable use, these spikes retain their original shape and stay sharp.

Made In The USA

Size - T x W x L	Bolt Spacing	Bolt Size	Order No.	List
1/4" x 1-3/4" x 9-1/16"	Single Hole	3/8"	P57-0063	15.45
1/4" x 1-3/4" x 11"	1" to 2"	3/8"	P57-0963	14.15
1/4" x 1-3/4" x 11"	1-3/4"	3/8"	P57-0965	19.25
1/4" x 1-3/4" x 11"	1-3/4"	7/16"	P57-0973	14.09
5/16" x 2" x 9-1/2"	1-3/4"	7/16"	P57-0072	12.35
5/16" x 2" x 10-1/2"	1-1/4" to 2-1/4"	7/16"	P57-0202	12.25
3/8" x 2" x 11"	1-1/4" to 2"	3/8"	ST20	10.49
3/8" x 2" x 11"	1-1/4" to 2"	7/16"	ST21	10.49
5/8" x 2" x 17"	2-1/4"	7/16"	45022	23.22
5/8" x 2" x 17"	2-1/4"	1/2"	45522	24.24
5/8" x 2" x 17"	2-1/4"	1/2"	45522H	63.04
5/8" x 2" x 17"	2-1/4"	3/4"	47522	28.72
5/8" x 2" x 15"	2-1/4" to 2-1/2"	1/2"	P57-0230	22.60
1" x 2" x 18"	2-1/4" to 2-1/2"	1/2"	P57-0260	43.92
1" x 2-1/2" x 18"	2-1/2"	1/2"	P57-0265	42.31

SHANK SAVERS - POLY

SOLD IN BOX QUANTITIES

Size/ Application	Hole Spacing	Bolt Size	Box Qty.	Order No	List
1-3/4" x 9" x 1/4"	1-5/8" to 2" Field Cultivators	3/8"-7/16"	100	P44-0360	320.11

CHISEL SHOVELS

Reversible spikes have upset (swedge) points for increased wear and longer life. Even after considerable use, these spikes retain their original shape and stay sharp.



505

P57-0350/0370

Size - T x W x L	Bolt Spacing	Bolt Size	Order No.	List
1/4" x 4" x 15-1/2"	2-1/4" to 2-1/2"	1/2"	505	12.93
1/2" x 4" x 15-1/2"	2-1/4" to 2-1/2"	1/2"	P57-0370	33.93
5/16" x 4" x 14-1/4"	2-1/4" to 2-1/2"	1/2"	P57-0350	17.13

CHISEL POINTS

200 SERIES

Reversible, No twist. 1-Piece. 2" Wide. 15" Long. 2-1/4" hole spacing. Made of high carbon steel. Heat-treated.

Thickness	Bolt Size	Description	Order No	List
5/8"	7/16"	Plain	25022	24.08
5/8"	7/16"	Hardfaced	25022H	65.36
5/8"	1/2"	Plain	25522*	24.08
3/4"	1/2"	Plain	27522	27.34

CHISEL POINTS - REVERSIBLE, TWISTED. 1-PIECE

1/2" Thick. 3" Wide. 22" Long. Fits all high clearance chisel plows. 1/2" Holes.

Width	Description	Bolt Size	Hole Spacing	Order No	List
3"	Plain, Left	1/2"	2-1/4" to 2-1/2"	TC125L	31.42
3"	Plain, Left	1/2"	2-1/4" to 2-1/2"	TC125LH	74.31
3"	Plain, Right	1/2"	2-1/4" to 2-1/2"	TC125R	31.42
3"	Plain, Right	1/2"	2-1/4" to 2-1/2"	TC125RH	74.31
4"	Plain, Left	1/2"	2-1/4" to 2-1/2"	P57-0271*	39.48
4"	Plain, Right	1/2"	2-1/4" to 2-1/2"	P57-0270*	39.48

*21" Long. 4" Wide

CHISEL POINT REVERSIBLE - 1 PIECE

2" Wide. 1/2" Bolt size. 2-1/4" to 2-1/2" hole spacing.

Thickness	Length	Hole Replaces	Description	Order No	List
1"	18"	HD88	Plain	P57-0260	43.92

SLASH POINTS - TWISTED CHISEL - 1 PIECE

One piece chisel will replace the complete three piece moldboard assemblies on chisel plows. 2-1/4" Hole spacing. .5" bolt size.

Fits Brillion, Bush Hog, Duetz-Allis, Glencoe, Kelly, Kent, Krause, Landoll, MF, Sunflower, Etc.

Description	Size	Order No.	List
Plain, Right	1/2" x 4" x 24"	SOS01	38.48
Hard-Faced, Right	1/2" x 4" x 24"	SOS01H	85.08
Plain, Left	1/2" x 4" x 24"	SOS02	38.48
Hard-Faced, Left	1/2" x 4" x 24"	SOS02H	85.08

SUBSOILER/RIPPER POINTS

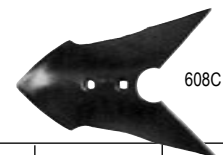

Size	Description	Cap	Bolt Size	Hole Spacing	Application	Order No.	List
1-1/4" x 1-7/8" x 7-1/4"	Capped	26CC	Drive-on	N/A	Caterpillar, Scarifier, Big Ox	BIGOXH	56.05
3/4" x 2-1/4" x 12"	Plain		Booted	N/A	Case, JD A17994, 90V, 900V, Q30681, Kelly	SS04	29.63
3/4" x 2-1/4" x 12"	Capped	08CC	Booted	N/A	JD AA31215, 510, 415, 55, 900, 910,913, 915 955, 2700, 2720, 2730, 2100 - 1/1/4" shanks	SS04H	50.93
3/4" x 2" x 10-1/4"	Plain		Booted	N/A	Brillion IJ481	SS07	32.91
3/4" x 2" x 10-1/4"	Capped	12CC	Booted	N/A	Brillion IJ481	SS07H	52.24
1" x 2" x 11"	Capped	12CC	Booted	3/8"x2" Roll Pin	New Kelly, KMC, 1" Shank	SS11H	46.24
3/4" x 2-1/2" x 12"	Plain		Form.Ear	1/2"x2-1/2"	M&W 60 & 65 Earthmaster Series	HA2438357	13.69
1-1/2" x 10"	Chrome Cap		Booted	N/A	DMI, Turbo Tiger®, Tiger Two®, Turbo Tiger II® Ecolo Tiger®	HA09907000	163.80
6"	Covering Point For HA09907000				527, 527B, 530B, 530C, 730B, 730C, 6750, 9300, ST650, ST720, ST775	608C	24.33
8"	Covering Point For HA09907000				530, 530B, 530C, 730, 730B, 730C, 9300, ST770, ST775	610C	24.06

SOIL RIPPER™

The new SoilRipper tillage points feature a robust design and superior fine grain chromium-carbide steel to withstand the most challenging soil conditions, providing the best overall value choice. Brought to you by the company you can trust for leading quality.

John Deere 510, 512, 55, 900, 910, 913, 915, 955, 2700, 2720, 2730, 2100 all with 1-1/4" wide shanks

DMI/CNH 500, 527, 527B, 690, 870, 875, 900, 1000, 1300, MRX690, ST720, ST740, 2500. ALSO FITS FRONT SHANK ONLY ON: 530, 530B, 530C, 730, 730B, 730C, 9300, ST770, ST775

KUHN/KRAUSE Dominator, Landbuilder, TL3000 Disc Ripper

FEATURES

- Patent pending
- More robust design with extra high strength steel for longer service life
- Wing and nose surface geometry generates maximum soil fracturing while reducing draft loads
- As they wear, SoilRipper points maintain their ability to penetrate the toughest soil conditions
- Wear feature protects mounting hardware
- Ideal for high speed compaction-busting tillage applications

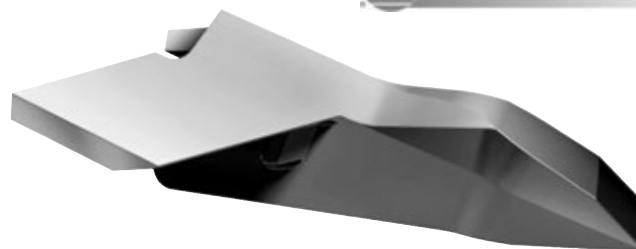

SPECIFICATIONS

- Solid one-piece cast for extreme durability with super hard steel
- Formed from fine grain chromium-carbide steel
- Rockwell hardness score of 48-50 Rc
- 7.5" winged SoilRipper point designed for a 1.25" shank width
- 24 lbs.
- Designed to fit Case-IH, DMI, Krause and John Deere equipment
- Additional designs, models and sizes to come

Order No. SS37C List 189.91

SUBSOILER CAPS - CHROMIUM CARBIDE



Size	Application	Order No	List
2" x 4"	Fits 1-3/4" Wide	26CC	8.72
2-1/4" x 4"	Fits 2" Wide	12CC	13.10
2-3/4" x 4"	Fits 2-1/2" Wide	07CC	17.79

FEROBIDE - EXCLUSIVELY FROM HERSCHEL PARTS!

APPLICATIONS

- Cultivators
- Subsoilers
- Direct Drills, Disc Drills and Air Drills
- Bed Formers
- Plows
- Power Harrows
- Packer Rollers

CUSTOMER BENEFITS

- Weld Anywhere Onto A Point
- Greatly Increases Point Lifetime
- Boost Productivity And Output
- Significantl Reduce Downtime
- Protect Vital Machinery Parts
- Maintain Hardness Of Metal Points
- Cut And Weld With Standard Tools
- Cut Costs And Save Money

KEY FEATURES

- Weldable
- Full Protection To Points
- Very High Impact Strength
- Superior Resistance To Chipping
- Resistance To Abrasion Directly Comparable To Tungsten Carbide
- Easy To Cut With Standard Tools
- Easy To Weld With Standard Tools

FEROBIDE uses a steel matrix to bond tungsten particles together. The unique forming process yields wear resistance similar to traditional tungsten carbide whilst allowing tiles to be easily cut and welded in place. This, combined with superior toughness, makes FEROBIDE the ideal choice for high impact and high abrasion situations.

By using FEROBIDE wear protection, farmers can significantl increase the working life of soil-engaging points, avoid lengthy downtime, and boost farm productivity.

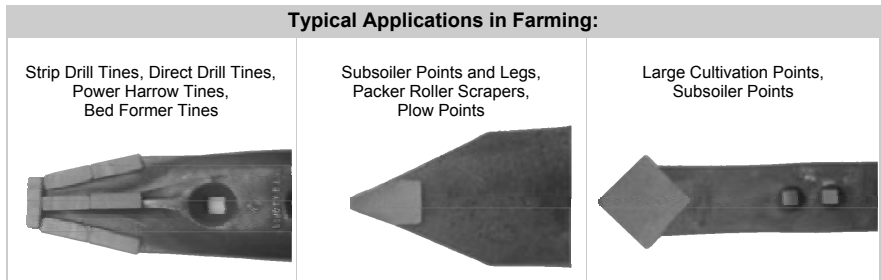

FEROBIDE EX-SMALL/SMALL

Size	Description	Order No	List
Ex-Small	.32 x 1.57"	FERXSMALL	77.58
Small	.59 x 1.57"	FERSMALL	115.58

Sold in packs of 10. Pricing shown is for one pack.

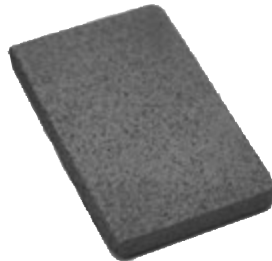

FEROBIDE MEDIUM

Size	Description	Order No	List
Medium	.98 x 1.57"	FERMED	192.60

Sold in packs of 10. Pricing shown is for one pack.

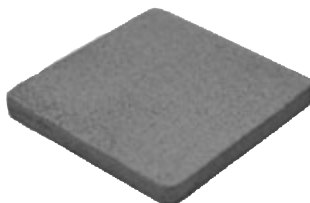

FEROBIDE LARGE/EX-LARGE

Size	Description	Order No	List
Large	.1.57 x 1.57"	FERLARGE	233.33
Ex-Large	.98 x 2.36"	FERXLARGE	286.81

Sold in packs of 10. Pricing shown is for one pack.

FEROBIDE

WORKING LONGER, FASTER, DEEPER

HARROW TINES

Replaces Number	Wire Gauge	Length A	Coil Width B	Coil Spacing C	Hole D	Application	Order No	List
143101	.375"	16-1/2"	9"	5"	1.69"	Degleman	T30-0001	12.31
1334	.375"	14-1/2"	7-1/4"	3-1/4"	1.75"	Flexi-coil	T30-0003	12.19
4341	.375"	16"	6-1/2"	Narrow	1.84"	Flexi-coil	T30-0004	15.04
P1546	.375"	11-5/16"	Single	Single	2.15"	Glencoe	T30-0006	7.72
8H-1110	.375"	12-3/4"	7-5/8"	Narrow	2.10"	Herman	T30-0007	15.48
H-1140	.375"	14-3/4"	5-3/4"	Narrow	2.10"	Herman	T30-0008	16.93
149781	.375"	11-1/4"	7-1/2"	3-1/2"	1.81"	Inland, Noble	T30-0009	10.87
N136767	.375"	13-1/2"	7-3/8"	3-1/8"	1.67"	John Deere, 1975-1981	T30-0010	11.97
N181162	.375"	12-3/4"	7-7/16"	3-1/8"	1.75"	John Deere, 1982-1985	T30-0011	12.72
1238	.375"	14"	2-5/8"	Single	2.25"	Kovar	T30-0012	8.71
N135002	.375"	12"	7-7/16"	3"	1.75"	John Deere, Before 1974	T30-0014	12.38
R-14-04710	.312"	10-3/4"	2-3/8"	Single	1.50"	Lindsay	T30-0015	5.11
L-14-04728	.312"	10-3/4"	2-3/8"	Single	1.50"	Lindsay	T30-0016	5.22
R-14-04752	.375"	11"	3-1/16"	Single	1.80"	Lindsay	T30-0017	7.84
L-14-04760	.375"	11"	3-1/16"	Single	1.80"	Lindsay	T30-0018	7.40
M1	.312"	11-1/2"	7-1/4"	3-1/2"	1.62"	Mattson	T30-0019	10.53
H-4087	.375"	16-7/8"	9"	5"	1.69"	Morris	T30-0025	14.92
R60000	.500"	20"	10"	5"	2.6"	Salford - NEW ITEM	HR60000	28.63
8H-1190S, 2070-28, BO21750, 4040-010	.562"	26"	12"	5-1/2"	2.5"	Summers - NEW ITEM	T30-1190	29.38
13419	.375"	12"	9-3/8"	5"	1.73"	Wilrich	T30-0027	11.48
16249, 16429	.375"	16"	9-3/8"	5"	1.63"	Wilrich	T30-0028	11.69

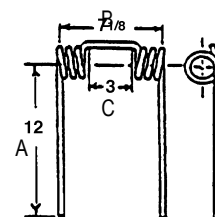

ANHYDROUS FERTILIZER (NH3) KNIVES

GROUND HOG KNIFE FRONT SWEEP SIDE MOUNT WITH ADALLOY CHROMIUM CARBIDE INSERT

- 1-7/8" Wide Foot Piece • 3/8" Tube w/63CC Tube Protector
- 33C Insert w/Sharp Leading Edge • Wears Sharp and Stays Sharp
- Foot Piece and Insert Work Together to Create a Tunnel or Expansion Chamber for the NH3.

Material Thickness: 1/2" x 2-1/2" x 15-1/8"
Hole Spacing: 1-1/4" to 2-3/4" • Bolt Size: 1/2"



Description	Order No.	List
Single 3/8" NH3 Open End Tube	AK33-1-O	90.32

FIELD CULTIVATOR KNIFE WITH ADALLOY CHROMIUM CARBIDE INSERT

Note: For 3/8" Punched Shanks, Use "Reducer Head" Plow Bolts. AK82 Series Knives Apply Nitrogen 3" to 4" Deeper Than Sweeps And Seal Well In All Soils. Adalloy Insert Extends Life 3-5 Times Over Hardfaced Knives.

Material Thickness: 7/16" x 1-3/4" x 12-1/2"
Hole Spacing: 1-3/4" to 1-7/8" • Bolt Size: 7/16"



Order No.	List
AK82-1	48.97

BACK SWEEP, SIDE MOUNT KNIFE WITH ADALLOY CHROMIUM CARBIDE INSERT

AK42 series knives are ideal for side dress, maximum till or no till applications. Back swept designs penetrate better and seal well in all soil conditions.

Material Thickness: 1/2" x 2" x 14-3/8"
Hole Spacing: 1-1/2" to 3" • Bolt Size: 1/2"



Order No.	List
AK42-1	61.18

FRONT SWEEP, SIDE MOUNT KNIFE WITH ADALLOY #62 CHROMIUM CARBIDE INSERT

AK62 series knives have the Adalloy #62 insert which extends 6-1/2" up the front. It "shatters" hard soil and wears sharp. Adalloy tube protector extends 4-1/2" up the back.

Material Thickness: 1/2" x 2" x 14"
Hole Spacing: 1-1/4" to 2-3/4" • Bolt Size: 1/2"



Description	Order No.	List
Standard	AK62-1	56.96

FRONT SWEEP, SIDE MOUNT KNIVES WITH ADALLOY #92 CHROMIUM CARBIDE INSERT

AK92 series knives have the Adalloy #62 insert which extends 6-1/2" up the front. Dual tubes also available for liquid or gas.

Material Thickness: 1/2" x 2-1/2" x 15"
Hole Spacing: 1-1/4" to 2-3/4" • Bolt Size: 1/2"



Description	Order No.	List
Standard	AK92-1	59.59
Standard with 3/8" Gas Tube w/Sealer	AK92-1S	49.90

1-Year Guarantee

On Everything We Offer! If it doesn't fit or work the way you expected, let us know. We will do what it takes to make it right!

FERTILIZER DISC OPENERS

Fits JD 7000, 7100, 7200, 7300. Dust cap required pn 0475-02935*
*Herschel assembled in the USA.

MADE IN THE USA! Made From High Quality Boron Steel. Includes hub & bearing.

13.5" x 2.54mm Assembly

Order No	List
HAA57466	56.82

UNIVERSAL COVERING CHAIN

Heavy Gauge Steel
Welded 3-Ring
Construction



Order No	List
C30-0050	9.21

JOHN DEERE AND KINZIE PLANTER SEED DISC OPENERS

Made In The USA. High Quality Boron Steel. Includes Hub & Bearing, Order Dust Cap Separately.

Fits John Deere 7000, 7100 Max Emerge, 7200, 7330, and 1700 Series Planters. Kinzie Planters except 3000 series. Double row bearing.



Heavy Duty Seed Opener Assembly. 3.5MM thick, 15" Diameter

Replaces	Order No	List
AA65248	HAA65248	48.75

UNIVERSAL DOUBLE DISC ASSEMBLIES

Hardware included. 2 per carton.

FLAT, 13-1/2" DIAMETER - "HERSCHEL" STYLE WITH DUST CAP

For Allis Chalmers Planter - Fertilizer, Case-IH Planter - Fertilizer & Seed, Crustbuster Red Box Drill, Crustbuster Silver Box Drill, Great Plains Drill, John Deere Drill, John Deere 7000, 7100 Planter-Fertilizer, John Deere 7200, 7300 Planter-Fertilizer, Lilliston, (Melroe) Drill, Morris Drill, Tye Drill, White 3400 & 5100 Planter - Fertilizer & Seed. MF 424, 425.



Order No.	List
B45-3194	115.29 /box of 2
B45-3194A	50.64 /Single No Hardware

FLAT, 15" DIAMETER - "HERSCHEL" STYLE WITH DUST CAP

For Great Plains 1999 & after, White 6000 series, John Deere 7000, 7100, 7200, 7300, 1700 Max Emerge 2 & Max Emerge Plus Planters - Seed, John Deere 7200, 7300 Planter - Seed, Kinzie Planter - Seed, New Idea Planter - Seed. 5/8" ID bearing.

Order No.	List
B45-3195	109.13 /box of 2

CAST DRILL POINTS - A SERIES Made In The USA

Adalloy Chromium Carbide Point. Improved Ground Penetration.



Application	Bolt Size	Order No.	List
IHC Eagle Beak 7400, 8500 etc. Bolts, Roll Pins & Nut included.	1/4" x 1-1/4"	11CC	24.50
John Deere, Crustbuster, AcraPlant, Great Plains, Mighty Handy w/V Groove		99CC	24.67

13-1/2" FLAT OEM STYLE DOUBLE DISC ASSEMBLIES

Application	Disc Assembly w/Hardware (2/Carton)	List	Blade Only		Bearing		Trash Shield or Dust Cap		Seal (10/Bag)		Seal Mtg. Spacer (10/Bag)		Washer/Spacer (10/Bag)	
			Each	List	Each	List	Each	List	Each	List	Each	List	Each	List
John Deere*			B45-3202	19.18			Not Req.				Not Req.			
Great Plains***			B45-3048	15.72			Use OEM		Not Req.		Not Req.			Not Req.
IHC**	B45-3089	152.42				Not Req.								
Marliss***					GP205	12.06			Not Req.		Not Req.			

* Fits: B, B-A, B-B, B-C, D-C, DF-B, DF-C, DR-A, DR-B, FB-B, FB-C, LL-A, LL 147, LL 166, PD-A, 450, 515, 520, 770, 780, 8100, 8200, 8250, 8300, 8500, 8550, 9300, 9350, 9400, 9450. **Will not work on Marliss drills with bolt-on hubs. ***Note: On IHC applications, the diameter of the disc assembly is 13-7/8". Fits 510, 5100, 620, 6200, 5200 *** Fits: All Models

13" CONCAVE OEM STYLE SINGLE DISC ASSEMBLIES

Application	Disc Assembly w/Hardware (2/Carton)	List	Blade Only		Bearing		Trash Shield or Dust Cap		Seal (10/Bag)	
			Each	List	Each	List	Each	List	Each	List
John Deere (Internal 1/2" threads). Fits: B, B-A, B-B, B-C, D-C, DF-B, DF-C, DR-A, DR-B, FB-B, FB-C, LL-A, LL 147, LL 160, LZ-B, PD-A, 8100, 8200, 8250, 8300, 8350. Replaces AM12419 & AN161227	B45-3410	132.99	B45-3046	21.07				Not Req.		
John Deere, New Style. (External 5/8" threads) Fits: 450, 515, 8100, 8200, 8250, 8300, 8350, 8500, 8550 Massey/Oliver	B45-3084	164.16	B45-3046	21.07				Not Req.		

14" CONCAVE OEM STYLE SINGLE DISC ASSEMBLIES

Application	Disc Assembly w/Hardware (2/Carton)	List	Blade Only		Bearing		Trash Shield or Dust Cap		Seal (10/Bag)		Seal Mtg. Spacer (10/Bag)	
			Each	List	Each	List	Each	List	Each	List	Each	List
Crustbuster								Not Req.				
IHC			B45-3045	23.91				Not Req.				
IHC, (Heavy Duty). 5/8" Bolt/Nut								Not Req.				
John Deere, Old Style (Internal 1/2" Threads) Fits: B-A, B-B, B-C, D-C, DF-8, DF-C, DR-A, DR-B, FB-B, FB-C, 8100, 8200, 8250, 8300, 8350. AN161227.			B45-3045	23.91				Not Req.				
John Deere, New Style (External 5/8" Threads) Fits: 450, 515, 8100, 8200, 8250, 8300, 8350, 8500, 8550	B45-3902	169.36	B45-3045	23.91				Not Req.				

DRILL DISC BLADES

Description	Replaces Number	Application	Disc Assembly Used In	Thickness	Center Hole	Bolt Hole	Bolt Circle	Order No.	List
14" Concave	PD1413	JD, IHC	B45-3408 B45-3409 B45-3902	.094	1.280	(6).265	2.500	B45-3045	23.91
13" Concave	PD1313	JD	B45-3410 B45-3084	.094	1.280	(6).265	2.500	B45-3046	21.07
13-1/2" Flat	820-002C	Great Plains	B45-3090	.100	1.580	(6).224	2.750	B45-3048	15.72
13-1/2" Flat	K202M	John Deere	B45-3200	.089	1.171	(6).265	2.500	B45-3202	19.18
18" Flat	N283804	JD 750, 1850, 1560, 1860 No Till Grain Drills		.203	3.031	(4).406	4.375	B45-3049	60.72
13-1/2" Raised Center	N164594			.100	.472			B45-3500	22.90

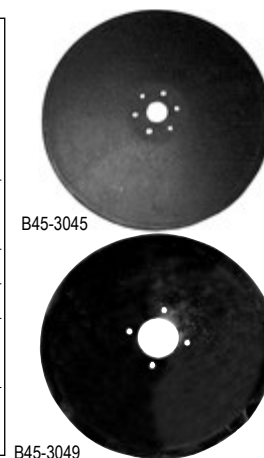

DRILL DISC BEARINGS

Replaces Number	Bore Size	Application	Order No.	List
Z9504AB	.750	Marliss Double Discs	GP205	12.06
	.629	Universal Double Discs, 13-1/2" & 15", 20010548, 2000575	GP205DDS	16.06



SEED BOOTS

Fits JD 750 Grain Drill & 1850 Air Seeder



OEM No	Description	Order No	List
N280446	Right Hand	HN280446	62.60
N280447	Left Hand	HN280447	62.60

NEOPRENE SEED AND FERTILIZER TUBES

Lower Diameter : 1-1/4"
Bolt OD: 1.25"



Working Length	Upper Diameter	Application	Order No.	List
17"	1-9/16"	JD Grain Drills	T82-0016	9.95
14"-30"	2-1/4"	Universal w/Eyelet	T82-0018	24.82

HARDWARE



Size	Description	Application	Pkg Qty	Order No	List
5/8" x 1-1/2" LH	Bolt Only	Universal Adams Style	Each	20010335	4.72

JOHN DEERE GRAIN DRILL REPLACEMENT PARTS

Fits 750 Grain Drills & 1850 Air Seeders

OEM Number	Description	Order No.	List
AN212132	Gauge Bearing	HAN212132	11.15
AA38447	Closing Wheel Assembly	HAA38447	38.10
N280447	SEed Boot LH	HN280447	62.60
AN213544	Seeder Blade Hub	HAN213544	45.95
N214190	18" Blade	B45-3049	60.72

HA22884



HAN213544



FARM SUPPLIES

Lead Free Enamel. Tractor & Implement paint is for machinery only. Not intended for use on toys, fence gates, or other objects. Paints must be shipped via UPS Ground ONLY. **Oil Based**



Sandable Gray Primer

High quality sandable acrylic primer can be used with a wide range of topcoats. Fast filling and low shrinking. Easy wet or dry sanding. 10-15 min dry to touch, 1 hour to sand/ topcoat. Excellent adhesion and holdout. Superior resistance to rust and corrosion. Covers approximately 300 sq ft per gallon.

Aerosol Order No. A 972608 16.86
Gallon Order No. A 952608 95.69



Fast Drying!

Description/Size	Order No.	List
------------------	-----------	------

ALLIS CHALMERS PERSIAN ORANGE 1960 & Older		
Gallon	A 951001	95.69
Quart	A 961001	39.22
12 oz. Aerosol	A 971001	16.86

ALLIS CHALMERS PERSIAN II		
---------------------------	--	--

(1961 & Later)		
Gallon	A 951002	95.69
Quart	A 961002	39.22
12 oz. Aerosol	A 971002	16.86

ALLIS CHALMERS CREAM		
----------------------	--	--

Quart	A 961003	39.22
Aerosol	A 971003	16.86

ALLIS CHALMERS CORP. ORANGE 200, 7000, 8000 Series		
---	--	--

Gallon	A 951004	95.69
Quart	A 961004	39.22
12 oz. Aerosol	A 971004	16.86

ALUMINUM		
----------	--	--

Gallon	A 952503	95.69
Quart	A 962503	39.22
12 oz. Aerosol	A 972503	16.86

Aluminum, High Temp		
12 oz. Aerosol	A 972507	16.86

BLACK		
-------	--	--

Black Gloss		
Gallon	A 952501	95.69
Quart	A 962501	39.22
12 oz. Aerosol	A 972501	16.86
Black, High Temp.-Flat		
12 oz. Aerosol	A 972506	16.86

CASE FLAMBEAU RED		
-------------------	--	--

Gallon	A 951501	95.69
Quart	A 961501	39.22
12 oz. Aerosol	A 971501	16.86

CASE DESERT SAND		
------------------	--	--

Quart	A 961502	39.22
12 oz. Aerosol	A 971502	16.86

Description/Size	Order No.	List
------------------	-----------	------

CATERPILLAR YELLOW (1980 To Present)		
Gallon	A 951101	95.69
Quart	A 961101	39.22
12 oz. Aerosol	A 971101	16.86

COCKSHUTT YELLOW		
------------------	--	--

Quart	A 961201	39.22
12 oz. Aerosol	A 971201	16.86

COCKSHUTT RED		
---------------	--	--

Quart	A 961202	47.06
12 oz. Aerosol	A 971202	16.86

FORD BLUE		
-----------	--	--

Gallon	A 951306	95.69
Quart	A 961306	18.93
12 oz. Aerosol	A 971306	16.86

FORD GRAY (8N, NAA, 600, 700, 800, 900 Series)		
--	--	--

Quart	A 961304	39.22
12 oz. Aerosol	A 971304	16.86

FORD LIGHT GRAY (2000 - 4000)		
-------------------------------	--	--

Gallon	A 951305	55.22
Quart	A 961305	39.22
12 oz. Aerosol	A 971305	16.86

FORD DARK GRAY (9N, 2N)		
-------------------------	--	--

Gallon	A 951303	95.69
12 oz. Aerosol	A 971303	16.86

FORD RED (Orange) 2000 - 4000		
-------------------------------	--	--

Quart	A 961302	18.93
-------	----------	-------

FORD RED (8N, NAA)		
--------------------	--	--

Quart	A 961301	39.22
12 oz. Aerosol	A 971301	16.86

FORD WHITE		
------------	--	--

12 oz. Aerosol	A 971307	10.42
----------------	----------	-------

Description/Size	Order No.	List
------------------	-----------	------

FARMALL RED (Prior To 1981)		
Gallon	A 951402	95.69
Quart	A 961402	39.22
12 oz. Aerosol	A 971402	16.86

IH/FARMALL 1939-1947 EQUIPMENT BLUE		
-------------------------------------	--	--

Quart	A 961405	39.22
12 oz. Aerosol	A 971405	16.86

INTERNATIONAL HARVESTER (1981 - Current)		
--	--	--

Gallon	A 951403	95.69
Quart	A 961403	39.22
12 oz. Aerosol	A 971403	16.86

IH HARVESTER WHITE		
--------------------	--	--

Quart	A 961404	39.22
12 oz. Aerosol	A 971404	16.86

J.D. 2-CYL. CLASSIC GREEN All 2-Cylinder Tractors		
--	--	--

Gallon	A 951701	95.69
Quart	A 961701	39.22
12 oz. Aerosol	A 971701	16.86

JOHN DEERE GREEN (Ag Green)		
-----------------------------	--	--

Gallon	A 951702	95.69
Quart	A 961702	39.22
12 oz. Aerosol	A 971702	16.86

JOHN DEERE YELLOW (Ag Yellow)		
-------------------------------	--	--

Gallon	A 951703	95.69
Quart	A 961703	39.22
12 oz. Aerosol	A 971703	16.86

KUBOTA ORANGE (1990 & Newer)		
------------------------------	--	--

Gallon	A 951901	95.69
Quart	A 961901	18.93
12 oz. Aerosol	A 971901	16.86

Description/Size	Order No.	List
FERGUSON GRAY		
Gallon	A 952001	133.04
12 oz. Aerosol	A 972001	16.86
MASSEY FERGUSON LIGHT GRAY		
Quart	A 962004	26.38
12 oz. Aerosol	A 972004	16.86
MF METALLIC FLINT GRAY		
Gallon	A 952003	95.69
Quart	A 962003	39.22
12 oz. Aerosol	A 972003	16.86
MASSEY FERGUSON RED		
Gallon	A 952002	95.69
Quart	A 962002	39.22
12 oz. Aerosol	A 972002	16.86
MASSEY HARRIS RED		
Gallon	A 952005	164.28
Quart	A 962005	39.22
12 oz. Aerosol	A 972005	16.86
MASSEY HARRIS STRAW YELLOW		
Quart	A 962006	91.70
12 oz. Aerosol	A 972006	16.86
McCORMICK-DEERING RED		
Gallon	A 952102	95.69
12 oz. Aerosol	A 972102	16.86
MINN-MOLINE PRAIRIE GOLD		
Gallon	A 952201	181.95
Quart	A 962201	39.22
12 oz. Aerosol	A 972201	16.86
MINNEAPOLIS-MOLINE RED		
Quart	A 962202	47.06
12 oz. Aerosol	A 972202	16.86
NEW HOLLAND RED		
Gallon	A 952302	95.69
12 oz. Aerosol	A 972302	16.86

Description/Size	Order No.	List
NEW HOLLAND YELLOW		
Gallon	A 952301	95.69
12 oz. Aerosol	A 972301	16.86
OLIVER GREEN (Early) 1938-44		
Gallon	A 952402	95.69
Quart	A 962402	39.22
12 oz. Aerosol	A 972402	16.86
OLIVER MEADOW GREEN - 1952 & Later		
Gallon	A 952403	95.69
Quart	A 962403	39.22
12 oz. Aerosol	A 972403	16.86
OLIVER WHITE - Clover White		
Quart	A 962401	58.04
12 oz. Aerosol	A 972401	16.86
OLIVER RED		
Quart	A 962404	47.06
12 oz. Aerosol	A 972404	16.86
OLIVER YELLOW		
Quart	A 962405	58.04
12 oz. Aerosol	A 972405	16.86
WHITE GLOSS		
Gallon	A 952502	95.69
Quart	A 962502	39.22
12 oz. Aerosol	A 972502	16.86
HIGH TEMPERATURE PAINT		
12 oz. Aerosol		
Black	A 972506	16.86
Aluminum	A 972507	16.86
PRIMERS		
RED OXIDE PRIMER		
Gallon	A 952504	95.69
Quart	A 962504	39.22
12 oz. Aerosol	A 972504	16.86
GRAY PRIMER		
Gallon	A 952505	95.69
Quart	A 962505	39.22
12 oz. Aerosol	A 972505	16.86

ACRYLIC HARDENER

Can be used as additive to improve the hardness of the paint film. In most cases, an increase in chemical resistance and improvement of gloss will occur. Provides chip resistant high gloss finish. 1/2 pint. Mix ratio: 1/2 pint to 1 gallon of paint.



Order No.	List
A 972508	39.22



ACRYLIC LACQUER CLEAR COAT

Use for a "Water Clear" non-yellowing gloss coat on tractors and equipment. Spray application recommended. Provides additional protection and fade resistance.

Use over properly cured tractor, equipment and industrial enamel.

Aerosol Order No.	A 972609	16.86
Quart Order No.	A 962609	39.22
Gallon Order No.	A 952609	95.69

BULLDOG® TUBE MOUNT JACKS

J01-0190



SIDE WIND

Load Capacity	Retracted Size	Extended Size	Clearance	Travel	Order No.	List
2000 lbs.	11-1/4"	21-1/4"	6-1/4"	10"	J01-0105	118.87
2000 lbs.	14-1/2"	29-1/2"	12"	15"	J01-0190	147.75
5000 lbs.	15"	30"	6-1/4"	15"	J01-0110	130.26

J01-0160



TOP WIND

Load Capacity	Retracted Size	Extended Size	Clearance	Travel	Order No.	List
2000 lbs.	11-1/4"	21-1/4"	7-1/4"	10"	J01-0120*	104.98
5000 lbs.	11-1/4"	21-1/4"	7-1/4"	10"	J01-0160	101.90
5000 lbs.	14-1/2"	29-1/2"	13-1/4"	15"	J01-0165	165.00

* REPLACEMENT PARTS FOR JACK NO. J01-0120 and J01-0125

Replacement Tube Section	J01-0015	10.79
--------------------------	----------	-------

A-FRAME JACKS - TOPWIND

Load Capacity	Retracted Bracket Height	Extended Bracket Height	Top Clearance Height	Travel	Order No.	List	
2000 lbs.							
with foot	8"	23-1/4"	14-1/2"	15"	J01-0230	34.49	
5000 lbs.							
without foot	8"	23-1/4"	14-1/2"	15"	J01-0235	48.22	
Foot for J01-0135. Includes hardware. Fits 2" tube. 1.7" tall						J01-0250	17.73

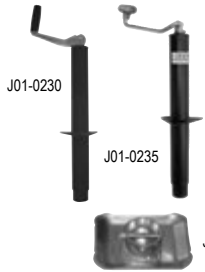

J01-0250

IMPORT IMPLEMENT JACKS

Greaseable gears. Includes weldable mating pipe end, pin and chain. Durable powder coat and zinc finish

TUBE MOUNT SIDEWIND

Load Capacity	Retracted Bracket Height	Extended Bracket Height	Top Clearance Height	Travel	Order No.	List
2000 lbs.	10"	10-7/8"	21"	5-7/8"	J01-0205	51.42
2000 lbs.	15"	14-3/4"	29-7/8"	12"	J01-0290	56.74
5000 lbs.	15"	14-3/4"	30"	6-7/8"	J01-0210	76.19

TUBE MOUNT TOPWIND

Load Capacity	Retracted Bracket Height	Extended Bracket Height	Top Clearance Height	Travel	Order No.	List
2000 lbs.	10"	11-1/4"	21-3/8"	6-7/8"	J01-0220	51.42
2000 lbs.	15"	15"	30-1/4"	7-3/4"	J01-0225	56.74
5000 lbs.	10"	11-1/4"	21-3/8"	6-7/8"	J01-0260	76.19
5000 lbs.	15"	15"	30-1/4"	7-3/4"	J01-0265	76.19

J01-0225

J01-0210

RATCHET & TURNBUCKLE JACKS



Replaces hydraulic cylinders or screw jacks in uses where infrequent adjustments are needed. All steel. 1-1/4" diameter clevis pin. 20" closed, 28" open.

Description	Order No.	List
Turnbuckle - 1-1/4" NC threads	J01-0270	114.01

48" HI-LIFT FARM JACK



Width:	5"
Height:	50.75"
Depth:	9.63"
Rated Load:	4660 lb.s.
Tested Load:	7000 lbs.
Winching:	5000 lbs.
Max Lift Height:	36.63"
Min. Lift Height:	4.5"

Order No.	List
J01-0485	168.27

Made in the USA

WELD-ON - BRACKET MOUNT

Lift Capacity: 2000 lbs
Travel: 10"
Retracted Bracket Height: 10-1/4"
Extended Bracket Height: 20-3/8"
Top Clearance Height: 7-3/4"

Order No. J01-0215 48.22

SIDE WIND TRAILER JACK

Load Capacity: 1000 lbs with 6" diameter caster
Retracted Size: 23-1/4"
Clearance: 12.7"
Travel: 10"



Order No. J01-0217 80.42



D-Series®

The D-Series lights produce extremely high output while consuming very little power. Its compact size and shape allows the light to fit almost anywhere and can be used in virtually any lighting application. Heavy duty and flush mount

Available In Sets Of 2 For Additional Savings!

Size	Lumens Actual	Shape	Pattern	Order No.	List
5" x 3-5/8"	1568	Square	Spot	LSS1568	126.04



This model is designed to retrofit PAR36 work lights. They are a superior upgrade over bulb-based work lights.

- Most popular model of replacement LED.
- PAR36 standard size fits numerous manufacturers and models
- Broad applications across wide array of equipment.

Size	Lumens Actual	Shape	Pattern	Order No.	List
4.5"	1020	Round	Flood	BRF1020	115.15



BRF1020

- Made In USA
- Meets or Exceeds OEM Specifications
- Industry Leading Performance And Reliability.
- Designed To Withstand The Rigors And Abuse of Agriculture, Off-Road And Construction.
- Honest Real-World Performance Ratings.

This model is a perfect retrofit for GE H4360-12V sealed beams. The durable construction and bright, white light produced by state-of-the-art LED's combine to make this model brighter and more reliable than any bulb-based 5" x 2" light.

- Popular model for many direct-fit, upgrade tractors
- Replaces John Deere #R161288

Size	Lumens Actual	Shape	Pattern	Order No.	List
5" x 2"	1000	Rectangle		LREC998	120.25

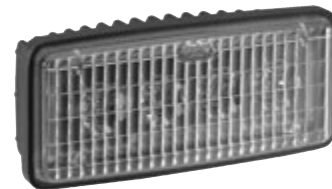

A slimmer and more powerful version than most PAR36 work lights. The polycarbonate housing and lens make it one of the most durable work lights on the market.

- Another unique torture tested light

Size	Lumens Actual	Shape	Pattern	Order No.	List
4.5"	860	Round	Flood	LRF860	99.09
4.5"	860	Round	Trap	LRT860	99.09





CARB & CHOKE CLEANER

Remove internal deposits. Use on all engines. Helps eliminate stalling & rough idling.

Order No. A10525

List
4.85



BELT DRESSING/CONDITIONER

Use on fan & V-belts, rubber belts & belt drives. Reduces slippage & noise. Cleans & Lubricates for Longer life.

Order No. A10530

List
6.12



GRAPHITE LUBRICANT

Non-stick. Reduces wear. Long lasting lubrication and protection.

Order No. A10535

List
7.44

ASSORTED PINS



COLD FORGED HITCH PINS

Pin Dia.	Usable Length	Order No.	List
1/2"	3-1/2"	A 693051*	3.72

* swivel handle



HOT FORGED HITCH PINS

Pin Dia.	Usable Length	Order No.	List
3/4"	4"	P34-0065	4.89
7/8"	4-1/4"	P34-0070	5.25



RED HEAD FORGED HITCH PINS

Pin with plastisol coated pull ring and hairpin.

Pin Dia.	Usable Length	Order No.	List
1/2"	3-5/8"	A 908111	4.77
1.125"	8-5/8"	A 757056	16.17
1.25"	8-5/8"	A 757057	18.35
1.5"	8-5/8"	A 757058	26.85

A 908111

ASSORTED CLEVIS

Max WWI - Maximum Working Weight



SCREW PIN CLEVIS

Pin Diam.	Body Diam.	Usable Length	Max WWI	Order Number	List
5/8"	1/2"	1-15/16"	6500	A 986125	7.69



TWISTED CLEVIS

Pin Diam.	Body Diam.	Usable Length	Max WWI	Order Number	List
1"	1"	5"	25000	C44-0110	41.95

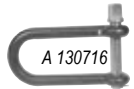

GENERAL PURPOSE CLEVIS

Pin Diam.	Body Diam.	Usable Length	Max WWI	Order Number	List
3/4"	3/4"	6-3/16"	10000	A 130716	19.22

A 130716

LYNCH PINS

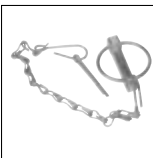

LOCKING LYNCH PINS

Description	Diam.	Order No.	List
Locking lynch pin, plain. Pkg. 5	1/4"	P34-0185B	1.77

TOPLINK & LIFT ARM BUSHINGS

Type	Fits Pin Cat.	Fits Arm Cat.	O.D.	I.D.	Length	Order Number	List
Top Link	1	2	1"	3/4"	2"	B82-0230B	1.60
Top Link	2	3	1-1/4"	1"	2"	B82-0240B	1.96

LIFT ARM DRAW PINS

Style 1 - Adjustable Shoulder



Style 2 - Fixed Shoulder



Style 3 - Roll Pin



Cat.	Shoulder	Pin Diam.	Usable Length	Overall Length	Thread Diam.	Order No.	List
1	Fixed	7/8"	1-3/4"	5-1/2"	7/8" NF	P34-0165	3.56
1	Adj.	7/8"	2"	6-3/16"	7/8" NF	P34-0195	5.84
1	Fixed	7/8"	2-1/4"	6-5/8"	7/8" NF	P34-0203	4.77
1 to 2	Adj.	1-1/8"	1-3/4"	5-1/8"	7/8" NF	P34-0115	5.91
2	Adj.	1-1/8"	1-3/4"	6-1/4"	1-1/8"	P34-0170	10.35
2	Roll Pin	1-1/8"	6-1/8"	7-3/4"	-	P34-0293	11.78
2	Roll Pin	1-1/8"	7-1/2"	9"	-	P34-0294	11.87

TOP LINK REPAIR ENDS



TOP LINK REPAIR ENDS

Cat.	Side	Thread Length	Thread Dia.	Order No.	List
2	Right	6-1/2"	1-1/8"	L35-0111	14.29
2	Left	6-1/2"	1-1/8"	L35-0120	14.60
2	Right	5-1/2"	1-1/4"	L35-0126	16.17
2	Left	5-1/2"	1-1/4"	L35-0125	16.17

FORGED TOP LINKS

All Top Links Include Handles.



A 890657

Cat.	Pin Hole Size	Thread Diam.	Body Length	Closed		Order No.	List
				Length	Length		
1	3/4"	1-1/8" NC	13-1/4"	18"	28"	L35-0189	40.71
1	3/4"	1-1/8" NC	20"	25"	35"	L35-0176	44.82
1	3/4"	1-1/8" NC	24"	29"	39"	L35-0177	34.20
1 & 2	3/4", 1"	1-1/8" NC	16"	21"	32"	L35-0178	46.89
2	1"	1-1/8" NC	20"	24"	36"	A 825847	50.29

REPLACEMENT BALLS & SOCKETS

LIFT ARM/TOP LINK REPLACEMENT BALLS



A = Pin Hole Size
B = Length Thru Bore
C = Sleeve Width

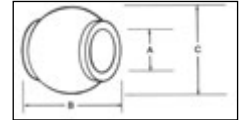

Type	Cat.	A	B	C	Order No.	List
Lift Arm	2	1-1/8"	1-3/4"	2"	A70-0246B	6.79

LIFT ARM BALL SOCKETS

A = Pin Hole Size
B = Length Thru Bore
C = Sleeve Width
D = Sleeve Outside Diam.

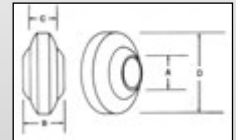

Cat.	A	B	C	D	Order No.	List
2	1-1/8"	1-3/4"	1-1/4"	3-1/8"	B05-0200B	21.40

LIFT ARM WELD-ON END (* Bent End)

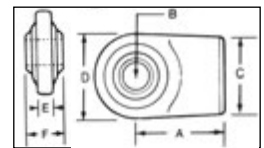

Cat.	A	B	C	D	E	F	Order No.	List
2	3-1/8"	1-1/8"	2-3/4"	3-1/8"	3/4"	1-3/4"	L35-0162	28.85

DRAWBARS

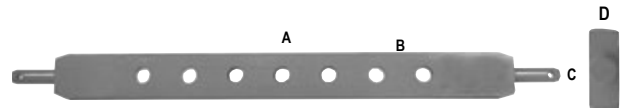

* Heat Treated

end view

Cat.	Holes	A	B	C	D	E	Order No.	List
1	11	26"	3/4"	7/8"	1"	2-1/2"	A 882837	48.16

TOP LINK PINS



Pin Cat.	Usable Diam.	Overall Length	Length	Order No.	List
0	5/8"	2-3/4"	4-7/16"	P34-0160	1.25
1	3/4"	3"	4-7/16"	P34-0130	2.16
1	3/4"	4-1/8"	5-7/16"	P34-0135	2.71
1	3/4"	5"	6-7/16"	P34-0145	2.87
2	1"	3-13/16"	5-21/64"	P34-0140	5.36
2	1"	4-3/8"	6"	P34-0025	5.25
2	1"	5-1/2"	7-1/4"	P34-0027	5.29

AGRICULTURAL HYDRAULIC TIE-ROD CYLINDERS

- Induction-hardened and hard-chrome-plated rods
- O-ring seals throughout with polyurethane back-ups on piston and rods
- High-tensile tie rods - Ductile base and rod clevis mountings
- Rod threaded at full diameter on 1.25" (31.75 mm) rods (clevis end only)
- Cylinder barrels honed to micro-finish
- Ports in line with pin holes on base and rod end clevis
- Double-ported base on 2" (50.8 mm) through 5" (127 mm) cylinders single port on rod end



C95-0005

Bore	Stroke	Retracted Length	Extended Length	Rod Dia.	Port Size	Pin Dia.	Order No.	List
2500 PSI CYLINDERS								
3"	8"	20-1/4"	28-1/4"	1-1/4"	1/2" NPTF	1"	C95-0010	302.24

HERSCHEL HYDRAULIC TIE-ROD CYLINDERS

- Chromed, polished and individually heat-treated shaft provides extended cylinder life.
- All cylinders are 100% hydraulically tested up to two times working pressure.
- Working pressure **2500 psi**.



Bore	Stroke	Retracted Length	Extended Length	Rod Dia.	Port Size	Pin Dia.	Order No.	List
2"	8"	20-1/4"	28-1/4"	1-1/8"	3/8"	1"	C95-2008	196.96
2"	10"						C95-2010	208.31
2-1/2"	8"	20-1/4"	28-1/4"	1-1/8"	3/8"	1"	C95-2508	198.98
3"	8"	20-1/4"	28-1/4"	1-1/4"	1/2"	1"	C95-3008	232.00
3"	10"	20-1/4"	30-1/4"	1-1/4"	1/2"	1"	C95-3010	253.38
3"	16"	31-1/2"	47-1/2"	1-1/2"	1/2"	1-1/4"	C95-3016	332.16
3.5"	8"	20-1/4"	28-1/4"	1-1/4"	1/2"	1"	C95-3508	281.58
4"	8"	20-1/4"	28-1/4"	1-1/4"	1/2"	1"	C95-4008	329.74
4"	16"	31-1/2"	47-1/2"	1-3/4"	1/2"	1"	C95-4016	489.79

FLUSH-FACE QUICK COUPLINGS FOR SKID STEERS AND ATTACHMENTS

- Pioneer Brand
- USA Made



F34-0301



F34-0302

Order Number	Thread Type	Thread Size	Coupler	Replaces	List
F34-0301	Female O-Ring Boss	7/8-14 UNF	Female	FEM-501-10FO-NL	109.08
F34-0302	Female O-Ring Boss	7/8-14 UNF	Male	FEM-502-10FO	55.07
F34-0303	Female O-Ring Boss	1-1/16-12 UNF	Female	FEM-501-12FO-NL	126.24
F34-0304	Female O-Ring Boss	1-1/16-12 UNF	Male	FEM-502-12FO	58.54
F34-0305	Female Pipe	1/2-14 NPSF	Female	FEM-501-8FP-NL	111.23
F34-0306	Female Pipe	1/2-14 NPSF	Male	FEM-502-8FP	58.60

BULK HYDRAULIC HOSE

Made In The USA
Compatible with Parker, Dayco and Gates fittings.
Not compatible with Weatherhead

- Oil and Weather Resistant
- -40° F TO +212° F Temperature Range



Firescreen II Formerly Farmex II Type at 100R16

- 2 Wire Equivalent

ID	Feet Per Reel	Operating Pressure	Burst Pressure	Order Number	List
3/8"	250 FT.	4000 PSI	16,000 PSI	H58-0802	4.13
1/2"	250 FT.	3500 PSI	14,000 PSI	H58-0804	5.55

Parker Type at 100R2

- 2 High Tensile Wire Braids

ID	Feet Per Reel	Operating Pressure	Burst Pressure	Order Number	List
1/4"	475 FT.	5000 PSI	20,000 PSI	H58-0710	3.62
3/8"	385 FT.	4000 PSI	16,000 PSI	H58-0712	4.24
1/2"	425 FT.	3500 PSI	14,000 PSI	H58-0714	6.01

HYDRAULIC HOSE ASSEMBLIES



- Male fittings on both ends.
- Neoprene cover is oil and weather resistant.

PSI Ratings

1/4"	2500 PSI
3/8"	4000 PSI
1/2"	3500 PSI

Length	1/4"		3/8"		1/2"	
	Order No.	List	Order No.	List	Order No.	List
12"	A 1021005	7.07				
18"	A 1021013	7.40				
24"	A 1021021	9.21	A 523282	10.71		
5'					A 523415	23.44
6'			A 523324	23.11	H58-0135	26.27
8'					A 523449	32.24
10'					A 523464	69.47
12'					A 523472	58.09

HYDRAULIC ADAPTERS



John Deere Old Style



Int. Harvester Old Style



Pioneer

Using Male Tip	Using Female Body	Order No.	List
Pioneer ISO	John Deere Old Style	A15-0225	51.14
Pioneer ISO	Int. Harvester Old Style	A15-0230	34.71
John Deere Old Style	Pioneer	A15-0235	57.00

SPECIALIZED COUPLERS



MALE TIPS

Thread Description	Size	Replaces	Order No.	List
John Deere "Old Style"	1/2" NPTF	5060-4	F34-0170	23.04
John Deere "Old Style"	3/4" ORB	5060-15	F34-0175	21.71
Case "Old Style"	1/2" NPTF	5080-4	F34-0188	29.07

PIONEER COMPLETE COUPLERS

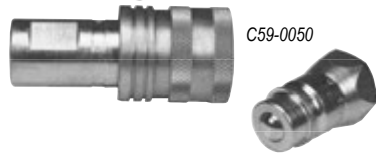

Replaces No.	Body Size	Replaces Male	Thread Size	Replaces Female	Thread Size	Order No.	List
4000-4	1/2"	8010-4	1/2"-14 NPTF	4050-4	1/2"-14NPTF	C59-0025	55.00
4000-15	1/2"	8010-15	3/4"-16 ORB	4050-15	3/4"-16 ORB	C59-0028	50.82
4200-4	1/2"	8010-4	1/2"-14 NPTF	4250-4**	1/2"-14NPTF	C59-0030	50.27

* Indicates Poppet Style which prevents uncoupled leakage.

** 4200 Series feature double acting sleeve for one handed operation when coupler is clamp or bulkhead mounted.

*** 8200 Series feature above plus unique valve design that permits connection while either or both coupler and nipple are under pressure.

PIONEER ISO COUPLERS

FEMALE BODIES



Body Size	Replaces	Thread Size	Overall Length	Wrench Flats	Largest Diameter	Order No.	List
1/2"	4050-4	1/2"-14 NPTF	2.60"	1.06"	1.52"	F34-0159	33.24
1/2"	4050-4P	1/2"-14 NPTF	2.60"	1.06"	1.52"	F34-0207*	37.62
1/2"	4250-4	1/2"-14 NPTF	2.68"	.94"	1.50"	F34-0165*	33.22

MALE TIPS

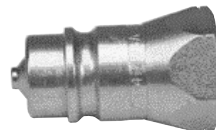

Body Size	Replaces	Thread Size	Overall Length	Exposed Length	Hex Size	Largest Diameter	Order No.	List
1/2"	8010-4	1/2"-14 NPTF	1.95"	1.09"	1.06"	1.23"	F34-0195	11.31
1/2"	8010-4P	1/2"-14 NPTF	1.95"	1.09"	1.06"	1.23"	F34-0203*	13.22
1/2"	8010-15	3/4"-16 ORB	2.06"	1.20"	1.06"	1.23"	F34-0196	19.95
1/2"	8010-15P	3/4"-16 ORB	2.06"	1.20"	1.06"	1.23"	F34-0204*	17.33
3/4"	4110-5	3/4"-14 NPTF	1.81"	1.23"	1.31"	1.52"	F34-0163	19.36

* Indicates Poppet Style

ROLLER CHAIN

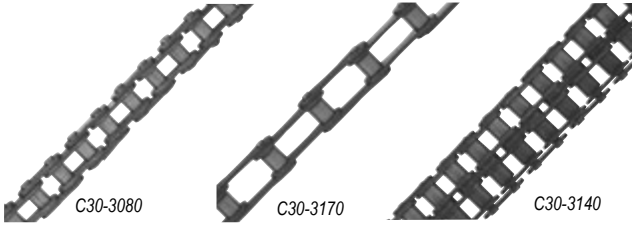

Our roller chain is made of selected hardened steel with wearing surfaces hardened for maximum chain life. Side plates are heavy to avoid stretch and rollers are held to close tolerance for better fit. Fully interchangeable with same size chain of other manufacturers and will fit all standard sprockets on combines, corn pickers and other farm machines. When ordering chain, the pitch is the distance between roller centers and the width is the distance between the inside edge of the side bar. Before ordering, check size of chain carefully by pitch and width.

Regular Roller Chain

Type Chain	Pitch	Approx. Width	Rollers Per Ft.	10' Order No.	Per Roll	50' Order No.	Per Roll	Connecting Link Order No.	List	Half Link/Offset Link Order No.	List
35	3/8"	3/16"	32	C30-3080	35.47			L35-0315	0.41	L35-0410	0.78
40	1/2"	5/16"	24	C30-3085	81.73	C30-3115	373.62	L35-0325	0.58	L35-0420	1.13
41	1/2"	1/4"	24	C30-3090	102.16	C30-3116	252.49	L35-0330	0.44	L35-0425	0.85
50	5/8"	3/8"	19	C30-3095	102.16	C30-3120	452.42	L35-0335	0.75	L35-0430	1.51
60	3/4"	1/2"	16	C30-3100	175.14	C30-3125	441.11	L35-0345	1.04	L35-0440	1.32
60H	3/4"	1/2"	16	C30-3150	110.92	C30-3160	464.31	L35-0355	1.13	L35-0445	2.24
80	1"	5/8"	12	C30-3105	213.77	C30-3124	707.58	L35-0360	1.73	L35-0455	3.84
80H	1"	5/8"	12	C30-3155	180.97			L35-0365	1.98	L35-0460	3.94
100	1-1/4"	3/4"	10	C30-3110	382.37			L35-0370	3.42	L35-0465	2.49

Extended Pitch Roller Chain

2040	1"	5/16"	12	C30-3170	67.14	C30-3185	297.73	L35-0395	0.96	L35-0490	1.71
2050	1-1/4"	3/8"	10	C30-3175	90.48	C30-3190	385.29	L35-0400	1.13	L35-0495	2.46
2060	1-1/2"	1/2"	8	C30-3180	119.67	C30-3195	548.74	L35-0405	1.38	L35-0500	2.84

Double Strand Roller Chain

40-2	1/2"	5/8"	24	C30-3135	62.10			L35-0328	0.28		
50-2	5/8"	3/4"	19	C30-3140	107.18			L35-0340	1.21		
60-2	3/4"	1"	16	C30-3145	159.89			L35-0350	1.51	L35-0450	2.24

STEEL LINK CHAIN

All link chain and attachment links are American made. Our link chain is made from hot rolled strip steel and manufactured on specially designed machines which accurately and uniformly fabricate completely assembled chain. The hook of each link is formed so that the link will not become uncoupled too readily, yet when placed in coupling position may be driven apart without injury. All our chain attachments and assemblies are tested for strength and inspected for dimensional accuracy.

Type	Links Per Roll	Roll Length	Order No.	List
#25	133	10'	C30-1006	75.87
#32	104	10'	C30-1010	83.65
#55	74	10'	C30-1040	90.84
#62	73	10'	C30-1046	127.58

T-BAR CHAIN LINK



T-BAR CHAIN

Type	Order No.	List
Regular Link	C30-4175	2.31

ATTACHMENT LINKS

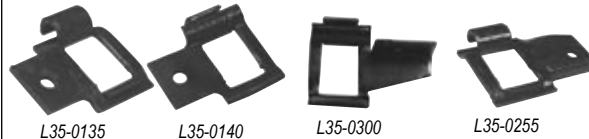

Chain Type	Link Type	Order No.	List
55	A1 Right	L35-0135	1.69
55	A1 Left	L35-0140	2.48
55	G27 Right	L35-0300	2.54
55	G27 Left	L35-0295	2.54

SEALED BALL BEARINGS - AEL OR RA SERIES



B15-2010D

- Prelubricated
- Spherical
- Eccentric Locking Cam
- Extended Inner Race One Side
- Individually Packaged

Order Number	Replaces Shaft Number	Fafnir Outside Number	Series	Size	Diameter	List
B15-2100D	AEL205-100	RA100NPPB	52	1"	2.0472"	16.52

DISC BEARINGS

Disc Bearing Identification Code

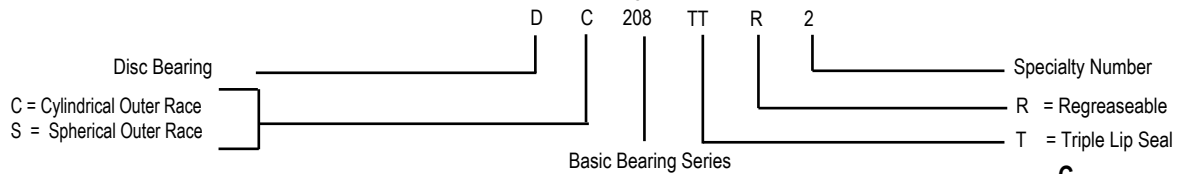

CYLINDRICAL OUTER RACE - DC SERIES

Bore Number	Outer Number	Outer Race Size (A)	Inner Race Diam. (B)	Width (C)	Width (D)	Order	BCA	List
B15-3180	DC208TT5	1-1/8", SQ	3.1496"	.709	1.438			29.43
B15-3190	DC208TT8	1-1/8", SQ	3.1496"	1.185	1.438			31.95
B15-3184	DC211TT3	1-1/2", SQ	3.397"	1.313	1.313			38.35
B15-3188	DC211TTR3	1-1/2", SQ	3.397"	1.313	1.313			42.73

SPHERICAL OUTER RACE - DS SERIES

Bore Number	Outer Number	Outer Race Size (A)	Inner Race Diam. (B)	Width (C)	Width (D)	Order	BCA	List
B15-3176	DS208TT6	1", SQ	3.158"	.709	1.438			36.06
B15-3050	DS208TT5	1-1/8", SQ	3.1496"	.709	1.438			27.89
B15-3110	DS208TT8	1-1/8", SQ	3.1496"	1.188	1.438			36.00
B15-3186	DS208TTR8	1-1/8", SQ	3.150"	1.188	1.438			32.45
B15-3170	DS208TT12	1-1/8", SQ	3.4340"	1.188	1.438			34.26
B15-3144	DS210TTR4	1-1/8", SQ	3.5433	1.188	1.188			59.23
B15-3185	DS209TT5	1-1/4", SQ	3.347"	1.188	1.438			52.86
B15-3080	DS208TT7	1-3/16", RD	3.1496"	.709	1.188			35.17
B15-3120	DS209TT4	1-1/2", RD	3.3465"	1.188	1.188			38.38
B15-3187	DS211TTR3	1-1/2", SQ	3.397"	1.313	1.313			49.80
B15-3150	DS211TT3	1-1/2", SQ	3.9370"	1.313	1.313			33.49
B15-3130	DS209TTR10	1-3/4", RD	3.3465"	.866	1.438			41.25

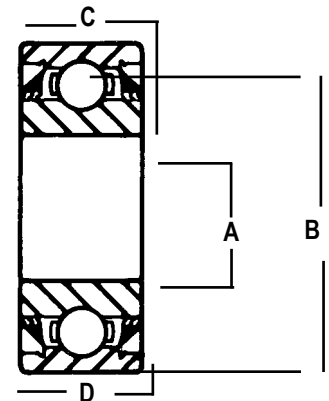

All heavy duty disc bearings feature long lasting triple lip seals.

RIVETED 4-BOLT FLANGE -- FD SERIES

Order Number	BCA Number	Bore Size	List
B15-3010	FD209RA, ST491A	1-3/4", RD	46.78
B15-3179	FD209RB	1-1/2", RD	38.95

BALE SPEARS

- High Tensile Strength Heat Treated Steel
- Standard Duty 2500# 1-3/4" Diameter
- Heavy Duty 3500# 1-3/4" Diameter
- Threaded Spears Include Nut

BETTER QUALITY. BETTER PRICE.

Assembling Advice For Square Tines



RIGHT



WRONG

BOLT ON SPEARS

Nut Included. Order Sleeve Separately.



Description	Length	Capacity	Order No	List
Threaded 36mm diameter	32"	1800 lbs	BS32ONEWN	53.25
Threaded 45mm diameter	32"	2500 lbs	BS32WN	76.13
Threaded 36mm diameter	39"	1800 lbs	BS39ONEWN	85.36
Threaded 45mm diameter	39"	2500 lbs	BS39WN	81.54
Threaded 45mm diameter	43"	2500 lbs	BS43WN	90.07
Threaded 45mm diameter	49"	2500 lbs	BS49WN	107.94
Threaded 45mm diameter	32"	3500 lbs	BS32WNHD	88.64
Threaded 45mm diameter	43"	3500 lbs	BS43WNHD	107.06
Threaded Heavy Duty	49"	3500 lbs	BS49WNHD	122.15

PIN ON SPEARS

Order Bushing/Sleeve Separately.



Description	Length	Capacity	Order No	List
Cross Bolt Standard Duty	43"	2500 lbs	BS43CB	90.48
Cross Bolt Standard Duty	49"	2500 lbs	BS49CB	109.13

HARDWARE

Description	Order No	List
Nut. 1.18" diameter	BSNUT	4.42
Sleeve Standard Duty. 4.72" long	BSSLEEVE	17.98
Sleeve Heavy Duty. 5.71" long	BSSLEEVEHD	21.30
Sleeve For Pin On w/1/2" hole. 5.71" long	BSSLEEVECB	20.24
Sleeve For 36mm diameter spears. 4.33" long	BSONESLEEVE	17.22

PTO SHAFT ASSEMBLIES - METRIC

FLEX WING MOWERS

COMPLETE MAIN DRIVELINES W/ CV JOINT*

BUSH HOG® MODEL NO.: 2415, 2515, 2615, 2720 & 3615

Tractor Yoke	Clamp Yoke	Series	Replaces	Order No.	List
1 3/8" x 6 Spl.	1 3/4" x 20 Spl.	BYPY8	14516855	BP855620CV	779.39
1 3/8" x 21 Spl.	1 3/4" x 20 Spl.	BYPY8	14616855	BP8552120CV	779.39
1 3/4" x 20 Spl.	1 3/4" x 20 Spl.	BYPY8	14716855	BP8552020CV	779.39

OVERALL COMPRESSED LENGTH - 55"

RHINO® MODEL NO.: SR-15, SE-15

Tractor Yoke	Clamp Yoke	Series	Replaces	Order No.	List
1 3/8" x 21 Spl.	1 3/4" x 20 Spl.	BYPY8	14606851	BP8512120CV	779.39

OVERALL COMPRESSED LENGTH - 51"

DEERE® MODEL NO.: 1517, 1518, 2018

Tractor Yoke	Clamp Yoke	Series	Replaces	Order No.	List
1 3/8" x 6 Spl.	1 3/4" x 20 Spl.	BYPY8	14516855	BP855620CV	779.39
1 3/8" x 21 Spl.	1 3/4" x 20 Spl.	BYPY8	14616855	BP8552120CV	779.39
1 3/4" x 20 Spl.	1 3/4" x 20 Spl.	BYPY8	14716855	BP8552020CV	779.39

OVERALL COMPRESSED LENGTH - 55"

FLEX WING MOWERS

COMPLETE WING DRIVELINES W/ FRICTION CLUTCH*

BUSH HOG®

Yoke	Clutch Yoke	OAL	Compressed	Replaces #	Order No.	List
1-3/8X6 SPL.	1-3/4X20 SPL.	64.11	14106660	BP661620C		649.52
1-3/4X20 SPL.	1-3/4X20 SPL.	63.18	14106661	BP6632020C		652.06

BUSH HOG®, JOHN DEERE AND SCHULTE

Yoke	Clutch Yoke	OAL	Compressed	Replaces #	Order No.	List
1-3/4X20 SPL.	1-3/4X20 SPL.	64.11	14106664	BP6642020C		777.13

ALL PURPOSE

TRACTOR YOKE	IMPLEMENT YOKE	OAL COMPRESSED	REPLACES	SERIES	ORDER NO	List
1-3/8X6 SPL. QD	1-3/8X6 SPL. QD	47"	14006247	BYPY2	BP24766	188.31
1-3/8X6 SPL. QD	1-3/8X6 SPL. QD	48"	14006448	BYPY4	BP44866	201.88
1-3/8X6 SPL. QD	1-3/8X6 SPL. QD	55"	14006455	BYPY4	BP45566	206.89
1-3/8X6 SPL. QD	1-3/8X6 SPL. QD	57"	14006657	BYPY6	BP65766	332.66

DISC MOWER

TRACTOR YOKE	IMPLEMENT YOKE	OAL COMPRESSED	REPLACES	SERIES	ORDER NO	List
1-3/8X6 SPL. QD	1-3/8X6 SPL. W/OVERRUNNING CLUTCH	39"	14306639	BYPY6	BP63966C	345.44

FERTILIZER SPREADER

TRACTOR YOKE	IMPLEMENT YOKE	OAL COMPRESSED	REPLACES	SERIES	ORDER NO	List
1-3/8X6 SPL. QD	1-3/8X6 SPL. QD	27"	14006127	BYPY1	BP12766	114.46

FINISHING MOWER

TRACTOR YOKE	IMPLEMENT YOKE	OAL COMPRESSED	REPLACES	SERIES	ORDER NO	List
1-3/8X6 SPL. QD	1-3/8X6 SPL. QD	37"	14006637	BYPY6	BP63766	237.91

ROTARY CUTTER

TRACTOR YOKE	IMPLEMENT YOKE	OAL COMPRESSED	REPLACES	SERIES	ORDER NO	List
1-3/8X6 SPL. QD	1-3/8 ROUND W/PINHOLE	36"	14006436	BYPY4	BP4366R	211.51
1-3/8X6 SPL. QD	1-3/8 ROUND W/PINHOLE	42"	14006442	BYPY4	BP4426R	217.77
1-3/8X6 SPL. QD	1-3/8 ROUND W/PINHOLE	52"	14006542	BYPY5	BP55266	281.63

BILL TO INFORMATION

Name _____
Customer Number _____
Street Address _____
P.O. Box _____
City _____ State _____ Zip _____
Daytime area code & phone number (____) _____
E-Mail Address _____
Customer No. (from back cover) _____

SHIP TO INFORMATION

Name _____
Street Address _____
P.O. Box _____
City _____ State _____ Zip _____
Daytime area code & phone number (____) _____

Item No.	Quantity	Product Description	(X) if Tax Exempt	Page	Price Each	Total

METHOD OF PAYMENT

Open Account (Qualified accounts ONLY) Visa

Check or Money Order Discover

American Express MasterCard

Credit Card Account Number _____ / _____

Security Code _____ Expiration Date (Month/Year) _____
(3 digit code on Back)

Signature _____

Merchandise Total _____

Shipping & Handling _____
(See Inside Back Cover For Details)

Sub-Total _____

Sales Tax _____
Calculate Your Local Sales Tax Here from the Sub-Total Listed Above

Total Amount _____

POLICIES

UPS GROUND SHIPPING



HAWAII AND ALASKA
ZONE B

Order Amount	Zone A	Zone B
0 - 99	\$10.75	\$50.00
100 - 150	\$15.75	\$50.00
151 - 250	\$20.50	\$50.00
251 - 500	FREE	\$75.00
501 - 750	FREE	\$100.00
751 - 1000	FREE	\$100.00
1001 & Up	FREE	\$100.00

- All orders are shipped FOB from our nearest warehouse or directly from the manufacturer or supplier.
- Most shipping charges are based on the merchandise total for your order (see chart).
- Some items are subject to additional freight or handling fees.
- Items exceeding standard shipper's weight or size limitations: ie: Rake Wheels and Sickle; will be shipped via freight truck. If liftgate is required additional fees may apply. Contact customer service for a freight quote.
- Orders ship within 24 business hours. Valid on in stock merchandise only.
- For faster delivery, request UPS Overnight, 2-Day or 3-Day Delivery from our customer service representative. Additional shipping charges will apply on expedited orders.
- Allow at least seven working days from the time your order is placed for delivery. We cannot be responsible for delays caused by UPS, Parcel Post or other freight companies, however, if you feel there has been an unreasonable delay, please contact us.
- For all orders shipped outside the 48 contiguous states, you will be charged the actual shipping charges. Please remit all orders in US funds. For Canadian Customers - Duty, GST and Brokerage Fees, PST (if applicable) will be collected at delivery. We will assist in figuring your shipping charges. Please call 1-888-828-3276 for assistance.

UPS GROUND TRANSIT TIMES - Shipped From Indianola, IA 50125



METHODS OF PAYMENT

We gladly accept Visa, MasterCard, Discover, American Express. Mail and Fax orders can pay by credit card, check, money order or cashiers check.

SPECIFICATIONS

- Merchandise prices and specifications are subject to change without notice.
- Prices listed in this catalog do not include freight. Please refer to the chart above for freight charges.
- Typographic, photographic or descriptive errors are subject to correction.

BACK-ORDERED ITEMS

We make every attempt to have all items in stock. However, in the event an item is back-ordered, it will be shipped as soon as possible.

SHORTAGES & CLAIMS

Please check merchandise immediately upon receipt and report any error at that time. If a part of the packaging is broken open or in bad condition, please note this on the carriers receipt when signing for it.

PRODUCT WARRANTIES

Limited Warranty

Herschel Parts warrants products it manufactures to be free of material defects in workmanship and materials at the time of manufacture. Products sold by Herschel Parts, but produced by manufacturers other than Herschel Parts, are warranted only to the extent of the manufacturer's warranty. The Herschel Parts warranty applies only to products properly installed and operated under normal conditions. This warranty does not cover diagnosis or installation labor. If, in the judgment of Herschel Parts, a product has been altered in any way, misused, improperly installed, or fails to perform satisfactorily due to operator error, this warranty shall be void. Herschel Parts is not liable for damages from or to equipment, damage to any property, personal injury (including death) or economic loss which results from purchase or use of any product sold or provided by Herschel Parts. Herschel Parts will repair or replace, at its option, any defective products as provided below.

THIS WARRANTY IS THE ONLY WARRANTY PROVIDED ON THE PRODUCTS. HERSCHEL PARTS DISCLAIMS ANY EXPRESS OR IMPLIED WARRANTIES WITH RESPECT TO THE PRODUCTS INCLUDING, BUT NOT LIMITED TO WARRANTIES OF MERCHANTABILITY AND FITNESS FOR A PARTICULAR PURPOSE.

TERMS OF COVERAGE:

Tillage Parts - 90 days from the date sold to end user

Plow Shares manufactured by Herschel Parts carry a 100% warranty if share measures over 4-1/8" wide behind the first bolt hole, or a 50% warranty if share measures 4" - 4-1/8". Shares worn to less than 4" are not covered under warranty. Hard faced shares operated in rocky conditions as determined by Herschel are not covered under warranty.

Cutting Parts - 90 days from the date sold to end user

Sickle failure due to head breakage - Herschel Parts will repair or replace only the head, not the entire sickle.

RETURNED MERCHANDISE

Please call toll free 1-888-828-3276 for return authorization prior to returning any product to Herschel Parts. Merchandise that is being returned for any reason must be sent prepaid to our Indianola, IA distribution center within 30 days of purchase. Exchange or refund will be made promptly when the returned merchandise is in good condition, unused, in original packaging with proper packing materials and the reason for the return is stated. A 15% restocking charge will be applied to all returns for reasons other than shipping or warranty. **Merchandise returned without return authorization paperwork may be refused.** Merchandise that has been installed is non-refundable. Parts returned due to our error are limited to refund of purchase price plus shipping charges. No returns on special order product.

SALES TAX EXEMPTION

Jurisdiction law requires us to charge the applicable sales tax to our customers that do not have current tax-exempt certificates on file.

Please use the following address to access our Exemption Certificate Portal to create or update a certificate:

<https://alamo-group-ecp.ondemand.vertexinc.com/vertex-ec/ALAMO-GROUP>

Step One: How To Create a User Account:

- Select "Create New User"
- Select "New Customer" and complete the form. If you know your customer number, please enter it as it appears on your invoices and add zeros at end of your number for a total of ten digits.

Once you create your account, you will be prompted to log back in to complete step two.

Step Two: Complete/Upload a Certificate

- Log in using the username and password created in step one
- Select "Create"
- Select all states in which you want to submit a certificate
- Choose the type of certificate
 - If a state requires a state issued document - you can upload the image
 - If a state does not require a state issued document - you create a new certificate
- Choose a "Blanket" exemption
- List the types of product you will be purchasing
- Follow remaining prompts
- Complete buyer information - update phone number
- Sign the forms - you may either sign with your mouse or upload a pdf of your signature

HERSCHEL PARTS™

Quality Ag Parts Since 1887

1301 N 14TH STREET • INDIANOLA, IA 50125

Customer Number:

Source Code:

TIGER SHARK™



TERMINATOR SWEEPS

Get the
Adams Edge.™

CONNECT WITH US!



Order Online www.herschelparts.com
Toll-Free Customer Service 888-828-3276
Mail Order/Store 1301 N 14th Street Indianola, IA 50125