



HERSCHEL

Manufacturing Quality Ag Parts Since 1887

CATALOG
HARVESTING
HAY/FORAGE
FARM SUPPLIES
PLANTER PARTS
TILLAGE TOOLS



PHONE: 800-247-2167 • WWW.HERSCHELPARTS.COM



HERSCHEL

Manufacturing Quality Ag Parts Since 1887

HARVESTING
HAY/FORAGE
FARM SUPPLIES
PLANTER PARTS
TILLAGE TOOLS

CATALOG

PLANTER PARTS

Check out our newly expanded line of John Deere and Kinze planter parts. All come with a 1-Year warranty.

See pages 150 - 153 for more details on this popular new addition.



ROUND BALER GATHERING WHEELS AND BELTING

See page 118 for more details



Med Rough Top

Clearcut Top

LMP Top

FREIGHT POLICY

ORDER VALUE	FREIGHT	COMMENTS
\$0-\$99.99	ACTUAL*	
\$100.00 - \$349.99	No Charge*	FRIDAY ONLY ORDERS VIA UPS GROUND.
\$350.00 - \$749.99	No Charge*	SHIPMENTS VIA UPS GROUND. QUALIFIED STOCKING DEALERS ONLY (ASK FOR DETAILS)
\$750.00 - \$1499.99	No Charge*	SHIPMENTS VIA UPS GROUND.
\$1500.00 and UP	No Charge*	SHIPMENTS VIA UPS GROUND OR TRUCK.

SEE PAGE 200 FOR MORE DETAILS ON OUR FREIGHT POLICY

UPS GROUND SHIPMENT TIME FROM INDIANOLA, IA 50125



ORDER TYPES

UPS Orders -	Placed by 3 pm CST, ship same day
LTL Orders -	Shipped Next Day
Program Orders -	Please allow up to 30 days from receipt of order for shipments. This pertains to Early Order Program orders, Zappers and any other special promotion or lot pricing.

©SALAMO GROUP INC 201605

PHONE: 800-247-2167 • FAX: 800-524-7481
WWW.HERSCHELPARTS.COM

SEE A DETAIL INDEX FOR EACH MAKE AT THE BEGINNING OF EACH SECTION

AGCO-ALLIS 9 - 13
CASE-IH 14 - 24
HESSTON 25 - 29
JOHN DEERE 30 - 40
MACDON 41 - 43
MASSEY 44 - 49
NEW HOLLAND 50 - 60
SHORTLINES 61 - 69
UNIVERSAL 70 - 73
ROTARY/FLAIL BLADES 74 - 76
GUARDS 77 - 88
TEETH 89 - 104
DISC MOWER KNIVES 105 - 109
COMBINE CONVERSION KITS 110 - 114
BALER BELTING 115 - 119
TILLAGE 120 - 164
ACCESSORIES 165 - 200

A

A-Frame Jacks 177
 Adapters & Couplers 189 - 191
 Additives 182
 Alabama Sweeps 154

B

Back-Up Alarm 175
 Bale Spears 187
 Baler Belts 115 - 119
 Baler Shear Bolts 71
 Baler Teeth 90, 97 - 100
 Battery Cables & Accessories 171
 Bearing Packer 180
 Bearings and Flanges 196 - 197
 Bulldog Jacks 177

C

Cab Heater 184
 Canopies 169
 Chain, Roller 194
 Chain, Tractor Tire 184
 Chisel Points 157 - 158
 Clevis 185
 Closing Wheels 149
 Combine Teeth 90
 Cotton Stalk Blade 141
 Couplers, Hydraulic 189
 Coulter Blades 141
 Cultivator Points 157
 Cylinders 188

D

Danish Sweeps 156
 Disc Bearings 144 - 147, 163
 Disc Blades 142 - 143
 Drawbars & Drawbar Parts 186
 Drill Cover Chain 136, 162
 Drill Openers and Points 162 - 163
 Drum Blades 105 - 109

E

Engine Heaters 175
 Exhaust Caps 178
 Exhaust Pipes & Extenders 178

F

Field Cultivator Sweeps 154
 Forage Harvester Teeth 97 - 100
 Freeze Plug Heaters 175
 Funnels 180
 Furrowers 155

G

Gauge Wheels and Bearings 149
 Gauge Wheel Covers 149
 Grain Drill Parts 162 - 164
 Graphite 153
 Grease Fittings 179
 Grease Fitting Repair Tool 180
 Grease Guns 179
 Ground Straps 171
 Guards 77 - 88

H

Hair Pins & Hitch Pins 185
 Hammer Lock Sweeps 155
 Harrow Teeth 102 - 104
 Hi Lift Jack 177
 Hold Down Clips 73
 Hoses & Cylinders 188 - 189
 Hydraulic Adapters 189 - 191
 Hydraulic Couplers 189
 Hydraulic Cylinders 188
 Hydraulic Pumps 190

I

Implement Jacks 177

J

Jacks 177
 Joyce Sweeps 154

L

Landsides 122 - 124, 138
 Lawn Tractor Seats 169
 Lift Arms and Parts 186
 Lights, Universal 172 - 174
 Listers 155
 Lubricants 183
 Lynch Pins 185

M

Manure Spreader Chain 199
 Mirrors 176
 Moldboards 137
 Muffler Clamps 178

O

Oil Cans 180

P

Paint 166 - 167
 Pillow Blocks 197
 Planter Closing Wheels 149
 Planter Gauge Wheels 149
 Plow Coat 136
 Plow Parts 137 - 140
 Points, Tillage 157 - 158
 Pumps and Motors 190

R

Radiator Hose 178
 Radiator Hose Heaters 175
 Radios 170
 Rain Caps 178
 Rake Teeth 91, 92 - 96
 Rake Wheels 92
 Reel Teeth 92
 Reflective Tape 175
 Ripper Blades 159
 Ripper Points 159
 Roller Chain 194
 Rotary Hoe Wheels 159
 Row Crop Sweeps 154

S

S-Tines and Sweeps 156
 Safety Pins 185
 Seal Puller 180
 Sealants 1=1
 Seats 168, 169

S Continued

Shares 138 - 140
 Shear Bolts 71
 Shins 132, 137
 Slow Moving Vehicle Emblem 175
 Soil Saver Points 158
 Sprayers 198
 Sprayer Parts 198
 Sprockets & Hubs 195
 Stabilizer Kits 186
 Sweeps 154 - 157
 Switches, Universal 171

T

Talc Powder 153
 Tedder Teeth 91, 92 - 96
 Terminator II Sweeps 155
 Three Point Parts 186 - 187
 Tiger Jaw Kits 110 - 114
 Tire Chains, Tractor 184
 Tool Boxes, Universal 176
 Top Links and Parts 186, 187
 Tube Mount Jacks 177

U

Umbrellas 169

V

Vertical Tillage 143

W

Weld-On, Jacks 177
 Wheatland Sweeps 156, 157
 Windrower Teeth 101
 Wing Sweeps 154

CHISEL POINTS REVERSIBLE, 1-PIECE

2" Wide. 1/2" Bolt. 2-1/4" to 2-1/2" hole spacing.

*2-1/2" Wide



Thickness	Length	Replaces	Bolt Size	Order No	Price
1"	18"	HD88	1/2" Hex Head	P57-0260	
1"	18"	SD235	1/2" Hex Head	P57-0265*	

CHISEL POINTS REVERSIBLE, 1-PIECE

4" Wide. 1/2" Bolt. 2-1/4" to 2-1/2" hole spacing.

* BEVEL ON TOP



Thickness	Length	Replaces	Bolt Size	Order No	Price
1/2"	21"	RH	1/2" Hex Head	P57-0270	
1/2"	21"	LH	1/2" Hex Head	P57-0271	

FURROWERS

HIGH BACK 400 SERIES

Heat treated boron steel for long life. 1/4" Thick.

7/16" Bolt Size for plow bolts.

1-1/4" to 2-1/4" hole spacing.

Width

Bottom	Order No	Price
10"	410	
12"	412	
15	415	
18	418	



CHISEL SHOVELS

4" Wide. 2-1/4" to 2-1/2" hole center. 1/2" bolt size.

Plain



Thickness	Length	Order No	Price
1/2"	15-1/2"	P57-0370*	

ROTARY HOE WHEELS

21" Diameter Wheel With Sealed Bearings

- Genuine Peer Bearing
- Proven In The Field

NEW LOW PRICE!

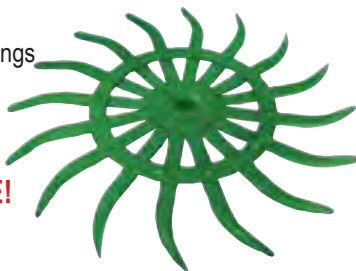

Order Number	Replaces Number	Color	Application	Price
W29-0303	AN142664 3400-111G	Green	JD Cultivator 75, 85 & RM, 400 Series, 415, 430 Yetter	
W29-0301	875-001-133 27-1830114 196-9217-C1 3400-111B	Black	Hiniker M&W Case-IH Yetter	



3-POINT SPRAYER

40 Gallon 4-Nozzle Boom. Powder coated high strength frame. Rugged poly tank with drain. 17' EPDM hose and hand gun. 2.0 GPM 12V on-demand pump. 120" coverage. Switched wire lead w/alligator clamps 10'.

Order No	Price
A 668670	

RED HEAD FORGED HITCH PINS

Pin with plastisol coated pull ring and hairpin.

NEW LARGER SIZES!

Pin Dia.	Usable Length	Order No.	Price
1/2"	3-5/8"	A 908111	
5/8"	5-1/2"	A 908145	
3/4"	6-1/2"	A 757047	
7/8"	6-1/2"	A 757054	
1"	8"	A 757055	
1.125"	8-5/8"	A 757056	
1.25"	8-5/8"	A 757057	
1.5"	8-5/8"	A 757058	



A 908111

BALE SPEARS

Bolt On Spears

Nut included. Order Sleeve Separately.



Description	Length	Capacity	Order No	Price
Threaded Standard Duty	32"	2500 lbs	BS39WN	
Threaded Standard Duty	43"	2500 lbs	BS43WN	
Threaded Standard Duty	49"	2500 lbs	BS49WN	
Threaded Heavy Duty	32"	3500 lbs	BS39WNHD	
Threaded Heavy Duty	43"	3500 lbs	BS43WNHD	
Threaded Heavy Duty	49"	3500 lbs	BS49WNHD	

Pin On Spears Order Bushing/Sleeve Separately.

Description	Length	Capacity	Order No	Price
Cross Bolt Standard Duty	43"	2500 lbs	BS43CB	
Cross Bolt Standard Duty	49"	2500 lbs	BS49CB	

UNIVERSAL END SECTIONS

HERSCHEL "End Sections" are made of heat-treated steel for rugged use. They are punched with an oblong hole to virtually fit any standard cutterbar mower in use today. To install our "End Section", simply take off the last section on the shoe end of your sickle assembly and replace it with an "End Section". The change-over takes only a couple of minutes to complete and you will notice a big difference in time saved from unclogging your mower. We recommend using R36-0523D oval head rivet or TJ55BN Bolt.

For all mowers, mower conditioners & windrowers w/standard cutterbar.

Description	Order No	Price
Tiger Shark™ (RH) 10/Box	S20-8403	
Tiger Shark™ (RH) 2/Card	S20-8403D	
Tiger Shark™ (LH) 10/Box	S20-8445	
Tiger Shark™ (LH) 2/Card	S20-8445D	

The first drastically new section tooth design in decades!

- Serrated Teeth Allows More Cutting Surface.
- Stays Sharper Longer
- Lasts Longer
- Cuts Faster
- Cuts Equally Well In Soybeans, Alfalfa, Grass Hay, Wheat, Etc.



Tiger Shark™ Section

10 Per Pack.



The first drastically new section tooth design in decades!

- Serrated Teeth Allows More Cutting Surface.
- Stays Sharper Longer
- Lasts Longer
- Cuts Faster
- Cuts Equally Well In Soybeans, Alfalfa, Grass Hay, Wheat, Etc.



Model	Description	Replaces OEM	Order No.	Price
Case-IH	3020, 3152, 3162	87728905	S20-8549	

DISC MOWER BLADES



Fits	R/L	6 Per BB	
		Order No.	Price
Fella SM165, 240, 215 etc	L	B45-6703D	
	R	B45-6704D	
Mortl HT130, 170, 210, 250, 290, 330, HTK290	R	B45-6760D	
	L	B45-6761D	



- Meets or Exceeds ISO 5718 Standards.
- Edges Are Formed, Not Ground To Prevent Chipping or Breaking.
- Made From USA 10B38(Boron) Steel.
- Entire Blade Is Heat-Treated to a RC Hardness of 45-52.

V-SHOT

- V-Slice proven technology, improving seed-soil contact.
- Uniform and early emergence, eliminate seed roll-and-bounce.
- Apply starter fertilizer where it belongs, below the seed.



Make	Model	Order No.	Price
JD	XP, XP Pro, ME5 Row Unit	HVSHOT1985	
JD	1986 - 2005 Max Emerge, ME Plus Row Units	HVSHOT1785	

Priced and sold per box of 4.

HEEL SWEEP

Thickness: 1/4"
 Width: 18"
 Shank: 50 degrees
 Holes: 2 holes
 1/2" slotted
 Hole Spacing: 2-1/4" - 2-1/2"



Application: Fits over top of a chisel plow shank and is used in conjunction with a chisel point being bolted on over the top of this heel sweep. Our CB75 or HA13S would be popular choices for this.

Benefits: Provides cultivating and chiseling in the same pass. It can also be used in manure application in some areas.

Order No	Price
HEEL18	

JOHN DEERE PLANTER PARTS

Many more John Deere and Kinzie planter parts are coming soon! If you don't see what you need, give us a call at 800-247-2167!

See pages 150 - 152 for more John Deere Planter Parts.

NEW ITEMS

**GAUGE WHEEL ASSEMBLY**

Fits: 7000 series planters, black nylon/ steel wheel halves w/885154b bearing & G25915 bearing spacer.

Order No: HAA41359

**GAUGE WHEEL ASSEMBLY - NYLON**

Steel wheel halves & 5203kyy2 bearing.

Order No: HA66604

**4.5" x 16" TIRE**

With standard profile offset. Fits John Deere planters XP, XP Pro row units; 1530, 1535 with XP. John Deere drills late 1590, 1690, 1835, 1890, 1895, 1990.

Order No: HA84062

**BEARING ASSEMBLY**

Bearing assembly for seed drive line, 7/8" hex bore. Replaces JD no. AA35646. Fits 7200 flex fold, 1710, 1760, 1770, 1780, & 1790.

Order No: HAA35646

**SPRING**

Standard down pressure spring for John Deere planters. Bolts to side of parallel arms. Two or four used per row. Replaces JD no. A43609. Used on Max Emerge & Max Emerge Plus.

Order No: HA43609

**SPRING**

John Deere tension left hand spring for heavy duty scraper, for John Deere 1700 series planter units and attachments.

Order No: HA41116

**SPRING**

John Deere tension right hand spring for heavy duty scraper, for John Deere 1700 series planter units and attachments.

Order No: HA41117

**SCRAPER**

John Deere heavy duty seed blade scraper for planter parts, model 7200, 7300, 1760, 1780. for use in sticky soils.

Order No: HA62182

**CLOSING WHEEL KIT**

John Deere complete closing wheel update kit for MaxEmerge 2. allows closing wheels to be offset to prevent trash build up. also fits MaxEmerge pro, XP, XP Pro.

Order No: HAP8833

**CLOSING WHEEL ARM**

Cast closing wheel arm for John Deere Max Emerge Plus, PRO, XP PRO, 1530, 1535 series.

Order No: HA86763

**CLOSING WHEEL ARM STOP**

Cast iron closing wheel arm stop, painted green. Fits 7000, 7100; Kinze (except 3000 series). Replaces JD No A28135, A33879; Kinze No GB0113.

Order No: HA33879

**OPENER GUARD**

Opener guard to fit 7200 and newer planters. Replaces JD no. A48879.

Order No: HA48879

PLANTER TALC AND GRAPHITE

TALC POWDER

- Maximizes yield and profit by increasing plant population per acre.
- Reduces moisture generated by vacuum planters.
- Helps prevent "bridging" of seeds in planter by reducing moisture.
- Helps seed flow smoothly and evenly through vacuum meter planters.
- Reduces wear on vacuum meter components.

Size	Order No.	Price
8 lb Jug	A 735300	
20 lb Box	A 735301	
20 lb Bucket	A 735302	



80/20 TALC GRAPHITE

- Designed exclusively for treated seed.
- Increases planting efficiency and maximizes yield per acre.
- Use in both "gravity flow" and "air" planters.
- Reduces moisture issues, lubricates seed and equipment.
- Helps prevent "seed bridging" in the planter.
- High-purity for less meter wear.
- Non-toxic
- Apply 4-6 oz each time hopper is filled with seed.

Size	Order No.	Price
8 lb Jug	A 735307	
20 lb Box	A 735308	
20 lb Bucket	A 735309	



Low Drift 80/20

12 lb Jug	A 735310
-----------	----------

50/50

12 lb Jug	A 735311
-----------	----------

GRAPHITE POWDER

- Maximizes yield and profit by increasing plant population per acre.
- Easiest, most convenient way to apply seed-flow lubricant. No buildup.
- Helps prevent "bridging" of seeds in the planter.
- Helps seed flow smoothly and evenly through high-speed planters.
- Reduces wear on planter plates.

Size	Order No.	Price
1 lb Bottle	A 735304	
5 lb Jug	A 735303	
20 lb Box	A 735305	
20 lb Bucket	A 735306	



EZ-MEASURE FLIP LID

New lid allows application with minimal human or wind exposure and gives precise amount measurements. Measures in 1/8 cup increments. Fits 5 lb jugs.



Order No: A 735312

LUBRICANTS

- **Agricultural/Industrial Strength**

- **OE Formulas**

- **Satisfaction Guaranteed**



CHAIN & CABLE LUBE

Penetrates rapidly to reduce friction & wear. Resists rust & corrosion. Use on all chain, cables & hinges.

Order No. A10510

Price



BRAKE & PARTS CLEANER

Safely removes fluid, grease, oil & contaminants. Use on all brake parts. Cleans & degreases without leaving residue.

Order No. A10515

Price



GLASS CLEANER

Foaming cleaner. Cleans quickly & easily. Cleans glass, mirrors, plastic & Stainless steel.

Order No. A10520

Price



CARB & CHOKE CLEANER

Remove internal deposits. Use on all engines. Helps eliminate stalling & rough idling.

Order No. A10525

Price



BELT DRESSING/CONDITIONER

Use on fan & V-belts, rubber belts & belt drives. Reduces slippage & noise. Cleans & Lubricates for Longer life.

Order No. A10530

Price



GRAPHITE LUBRICANT

Non-stick. Reduces wear. Long lasting lubrication and protection.

Order No. A10535

Price



R-Series®

This model is designed to retrofit PAR36 work lights. The R-Series fits into most round light cavities on over 400 different models of tractors and is quick and easy to upgrade any machine in your fleet. 4-1/2" diameter.



- Lifetime Warranty
- Made In USA
- 3X More Housing Surface For Maximum Cooling.
- Up To 50,000+ Hour Lifespan
- 9 - 36 Volt
- Reverse Polarity
- 20' Wire Harness With Rocker Switch
- Waterproof Deutsch Connector
- -40° F to 145° F Operating Temp
- Bracket Included

Lumens Actual	Shape	Pattern	Order No.	Price
1800	Round	Flood	BRD1800	

Dually XL™

Everything you expect from the innovative D-Series is now available in a bigger and brighter package. Includes unbreakable polycarbonate lens, durable UV-resistant polyester powder coat, stainless steel hardware and vibration isolator.



Size	Lumens Actual	Shape	Pattern	Order No.	Price
5" x 3-5/8"	3096	Square	Drive	LSD3096	

D-Series®

The D-Series lights produce extremely high output while consuming very little power. Its compact size and shape allows the light to fit almost anywhere and can be used in virtually any lighting application. Heavy duty and flush mount.

Available In Sets Of 2 For Additional Savings!



Size	Lumens Actual	Shape	Pattern	Order No.	Price
5" x 3-5/8"	1568	Square	Flood	LSF1568SET	
5" x 3-5/8"	1568	Square	Flood	LSF1568	
5" x 3-5/8"	1568	Square	Spot	LSS1568	
5" x 3-5/8"	1568	Square	Spot	LSW1568SET	

SR-M® and SR-Q®

The very compact yet efficient SR-M is ideal for any lighting need you might have. The SR-Q has a sleek, low profile configuration allowing the light to fit almost anywhere, while providing you with the same output as the D-Series.



Size	Lumens Actual	Shape	Pattern	Order No.	Price
4-3/16" x 2-3/8"	880	Rectangle	Flood	LRECF880	
4-15/16" x 1-13/16"	1568	Rectangle	Flood	LRECF1568	
4-15/16" x 1-13/16"	1568	Rectangle	Flood	H90511*	

*This is a pair of LRECF1568.

SR-Series®

The SR-Series LED light bars provide a sleek, yet powerful low profile lighting solution that measures less than 2" tall. The SR-Series is designed to project light at extreme distances while consuming very little power.

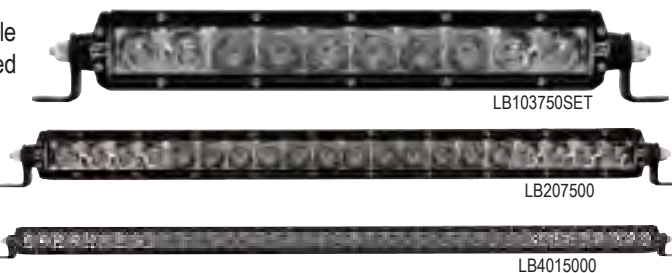

Size	Lumens Actual	Shape	Pattern	Order No.	Price
10"	3750	Straight	Combo	LB103750SET	
20"	7500	Straight	Combo	LB207500	
40"	15000	Straight	Combo	LB4015000	



- *Made In USA*
- *Meets or Exceeds OEM Specifications.*
- *Industry Leading Performance And Reliability.*
- *Designed To Withstand The Rigors And Abuse of Agriculture, Off-Road And Construction.*
- *Honest Real-World Performance Ratings.*

NEW ITEMS

This model is designed to retrofit PAR36 work lights. They are a superior upgrade over bulb-based work lights.

- Most popular model of replacement LED.
- PAR36 standard size fits numerous manufacturers and models.
- Broad applications across wide array of equipment.

Size	Lumens Actual	Shape	Pattern	Order No.	Price
4.5"	1020	Round	Flood	BRF1020	
4.5"	1020	Round	Trap	BRT1020	

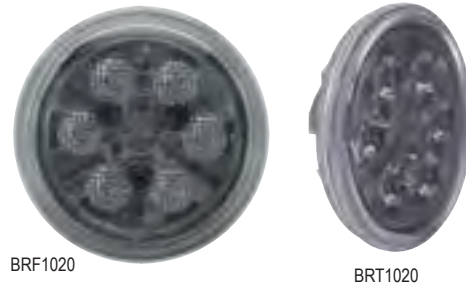

This model is a perfect retrofit for GE H4360-12V sealed beams. The durable construction and bright, white light produced by state-of-the-art LED's combine to make this model brighter and more reliable than any bulb-based 5" x 2" light.

- Popular model for many direct-fit, upgrade tractors.
- Replaces John Deere #R161288

Size	Lumens Actual	Shape	Pattern	Order No.	Price
5" x 2"	1000	Rectangle		LREC998	

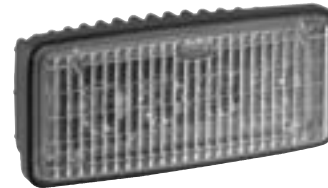

This narrow oval LED work light was designed with agriculture in mind.

- Direct replacement for John Deere part numbers RE269638 and RE269640.

Size	Lumens Actual	Shape	Pattern	Order No.	Price
7" x 3"	2200	Oval Flood		LOF1600	



A slimmer and more powerful version than most PAR36 work lights. The polycarbonate housing and lens make it one of the most durable work lights on the market.

- Another unique torture tested light

Size	Lumens Actual	Shape	Pattern	Order No.	Price
4.5"	860	Round	Flood	LRF860	
4.5"	860	Round	Trap	LRT860	



ROUND BALER GATHERING WHEELS

- Unique blend of rubber compounds offering durability and performance.
- Tough rubber fingers resist breakage and provide a longer service life.
- More hay in the baler!

Make/Model	Description	Order No.	Price
CASE-IH			
8450 & 8455	24" x 9" Hub & Wheel 24" x 9" Gathering Wheel	W29-0400 W29-0405	
GEHL			
1500, 1600, 1850, 1860	28" x 12 Gathering Wheel	W29-0415	
HESSTON			
530, 540, 745	24" x 9" Hub & Wheel Replacement Wheel	W29-0400 W29-0405	
550, 555, 560, 565	Wheel Wedge (3 per wheel)	W29-0410	
5540 & 5545	Wheel Wedge (3 per wheel)	W29-0410	
5580 & 5585	Wheel Wedge (3 per wheel)	W29-0410	
JOHN DEERE			
430, 435, 466, 467	Wheel Wedge (3 per wheel)	W29-0410	
MASSEY FERGUSON			
1560, 1745	24" x 9" Gathering Wheel	W29-0405	
NEW HOLLAND			
640, 648, 660, 688	28" x 12 Gathering Wheel	W29-0415	
VERMEER			
504 I, 504 L, 504 SI, 505 I, 504 SI, 554 XL, 555 XL, 604 J, 604 K, 605 J, 605 K, 604 L, 605L, 605 SJ, 604 SJ, 604 XL, 605 XL, 5400 Rebel, 5410 Rebel, 5420 Rebel, 5500 Rebel, 5520 Rebel, 540 M Classic, 664 Rancher, 665 Rancher, 6640 Rancher, 6650 Rancher	24" x 9" Gathering Wheel	W29-0405	
504 F, 504 G, 504 H, 605 F, 605G, 605H	28" x 12" Gathering Wheel	W29-0415	



W29-0400

HUB AND GATHERING WHEEL ASSEMBLY

Gathering wheel hub and wheel assemblies are available to replace older syle wheels commonly found on many earlier baler models. Wheel assembly can be mounted on either side by simply loosening the bolts and reversing the hub assembly. Bearings not included.



W29-0405

W29-0415

GATHERING WHEEL

Wheels provide the reliable performance you expect from OEM quality gathering wheel. Bolt holes are pre-punched for ease of installation and offered pattern fits most balers equipped for this wheel style.



W29-0410

WHEEL WEDGE

Die-cut from 4-ply 440 1/4" x 1/16" grade 2 industrial conveyor belt, three segments can be combined to make a single wheel. Segments provide a durable and economical wheel option and is ideal for certain older model balers.

PRE-CUT ROUND BALER BELTS

- Nylon fabric reinforcement in the outer ply to help the belt stretch under heavy loads.
- Polyester center ply helps lace retention and stablase belt
- Belt & lacing meet or exceed OEM specifications
- 3-Ply belt offers increased durability saving downtime.

See Pages 116 -118 For Additional Baler Belts/Fasteners

Make/Model	Description	Order No.	Price
CASE-IH			
RBX461,561, 562 NH, 650, 654, BR750, 660, 664, 668, 780, BR780	7" X 420.5" 3-Ply Mini Rough Top With Clipper	CNH7X420MC	
JOHN DEERE			
430, 435, 466, 467, 530, 535, 566, 567	7" x 531" 3-Ply Diamond Top With Alligator Lacing 7" x 525" 3-Ply Diamond Top With Alligator Lacing	JD7X531DA JD7X525DA	
VERMEER			
504 I (older model), 504-IS(silage), 505 Super I, 504 Super I, 5400 Rebel, 504L, 505-I (older model)	6" x 424" 3-Ply LMP Top With Clipper Lace	VER6X424IMC	



Mini Rough Top



Diamond Top

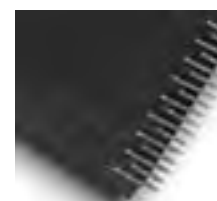

LMP Top

B	
Bale Counter.....	12
Bearings, Plastic Reel.....	12
Board, Grass.....	12
Bolts, Section.....	10
C	
Chains, Corn Head.....	13
Chains, Gathering.....	13
Clips, Hold Down.....	12
Corn Head Chains.....	13
Corn Head Knives.....	13
E	
End Sections.....	10
F	
Feeder Chain Sprocket.....	13
G	
Gathering Chain Sprockets.....	13
Grass Board.....	12
Guards.....	12
H	
Hammer Rivets.....	13
Hammer Rivet Tool.....	13
Hold Down Clips.....	11
I	
Idler Pulleys.....	13
K	
Kits, Poly Skid Shoe.....	13
Kits, Spliced.....	11
Kits, Straw Chopper Knife.....	13
Knives, Corn Head.....	13
P	
Pick-Up Teeth.....	12
Plastic Reel Bearings.....	12
Plastic Tines.....	12
Poly Replacement Parts.....	13
Poly Skid Shoe Kits.....	13
Pulleys, Idler.....	13

R	
Reel Tines.....	12
Reel Tube Assemblies.....	12
Rivets, Hammer.....	13
Rivets, Section.....	10
S	
Sections.....	10
Section Bolts.....	10
Section Rivets.....	10
Sickle Assemblies.....	11
Sickle Heads.....	11
Skid Shoe Kits.....	13
Spliced Sickles.....	11
Splice Kits.....	11
Sprocket, Feeder Chain.....	13
Sprockets, Gathering Chain.....	13
Straw Chopper Knife Kits.....	13
T	
Teeth, Pick-up.....	12
Tines, Reel.....	12
Tube Assemblies.....	12
W	
Wear Plate.....	12

SECTION TYPE ABBREVIATIONS

Section Finish	Section Type	Section Thickness
CR = Chrome	7TS = Super 7 Top Serrated SM = Smooth US = Under Serrated TS = Top Serrated TT = Tiger Tooth TJ = Tiger Jaw	XH = Extra Heavy .116"

UNIVERSAL SECTIONS

OEM Number	Size W x L	Description	Application	Reference Number	Rivet Used	Pkg. Qty.	Order No.	Price
70802535	3" x 3 3/16"	XHSM	All Mowers		9/16 OH	10	S20-1142	
70802541	3" x 3 3/16"	XHUS	All Mowers	A-	9/16 OH	10	S20-5246	
70804709	3" x 3 3/16"	XHUSCR	All Mowers	A-	9/16 OH	10	S20-6344	
71122784	3" x 2 7/8"	XHTSCR	Combines, A & N Series	O	9/16 OH	10	S20-4553	
71135135	3" x 2 7/8"	XHTSCR	Series 3, 300, 500	O /No C/S	5/8 OH	10	S20-4683	
71348175	3" x 2 7/8"	XHTSCR	Series 3, 300, 400, 500.	O /C/S Top	TJ55 Bolt	10	S20-4279	
SS71135135	3" x 2 7/8"	XH7TSCR	600, 700 and 800	O+ /No C/S	9/16 OH	10	S20-4285	
71176531	3" x 2 1/2"	XHTSCR	Combines, Floating Bar (Soybean) Series 1 & 2	H /C/S Bottom	5/8 CS	10	S20-4462	
SS71176531	3" x 2 1/2"	XH7TSCR		H+ /C/S Bottom	5/8 CS	10	S20-4322	



TIGER JAWS® SECTIONS

Replaces Number	Size	Description	Application	Reference Number	Bolt Used	Pkg. Qty.	Order No.	Price
TJ6000	3" x 3-1/4"	XHTJCR	Combines w/Tiger Jaws	S	TJ55BN	10	S20-4638	
SSTJ6000	3" x 3-1/4"	XH7TJCR	Combines w/Tiger Jaws	S+	TJ55BN	10	S20-4316	



UNIVERSAL END SECTIONS

HERSCHEL "End Sections" are made of one-piece high carbon, heat-treated steel for rugged use. They are punched with an oblong hole to virtually fit any standard cutterbar mower in use today. To install our "End Section", simply take off the last section on the shoe end of your sickle assembly and replace it with an "End Section". The change-over takes only a couple of minutes to complete and you will notice a big difference in time saved from unclogging your mower. We recommend using a R36-0523D oval head rivets or B55-0065D Bolts.

Description	Order No	Price	Description	Order No	Price
XH7TSCR (RH) 10/Box	S20-4403		XHTS CR (RH) 2/SP	S20-4210D	
XH7TSCR (RH) 2/SP	S20-4403D		XHTSCR (LH) 10/Box	S20-4211	
XH7TSCR (LH) 10/Box	S20-4445		XHTSCR (LH) 2/SP	S20-4211D	
XH7TSCR (LH) 2/SP	S20-4445D		XHUSCR (RH) 10/Box	S20-6640	
XHTS CR (RH) 10/Box	S20-4210		XHUSCR (RH) 2/SP	S20-6640D	



SECTION BOLTS

Description	Application	Qty. Pkg.	Mstr. Ctn.	Order No	Price
Overlap Bolt w/Low Profile Nut, 1/2" CS	Double Drive Sickles (use with Allen Wrench)	10	60	B55-0059D	
Section Bolt, 9/16" CS	Replaces Rivets for Bolt-on Convenience	20	120	B55-0056D	
Head Bolt, 1" CS	Replaces Rivets for Bolt-on Convenience	10	60	B55-0058D	
Section Bolt w/Nut	Universal - Replaces 9/16" & 5/8" Rivets	50	300	B55-0065D	
Head Bolt w/Nut	Universal - Replaces 1" & 1-1/16" OH Rivets	15	90	B55-0085D	
Head Bolt w/Nut	Universal - Replaces 1-1/4" OH Rivets	12	72	B55-0095D	
Section Bolt w/Nut	Universal - Bolts for 10' Sickle w/head bolts (80 - TJ55BN, 5 - TJ85BN, 5-TJ95BN)	90	Each	B55-0500D	
Nut	Universal	20	120	N83-0289D	



SECTION RIVETS - ZINC PLATED

OH = Oval Head CS = Counter Sunk

Size/No. in Pkg.	Application	Qty. Pkg.	Mstr. Ctn.	Order No	Price
5/8" # 5-1/2 (56)	7" Heavy Mower Sections and Knife Heads	Asst.	6	R36-0523D	
1" # 5-1/2 (10)					
5/8" # 5-1/2 (72)	Mower Conditioners	Asst.	6	R36-0524D	
1" # 5-1/2 (5)					
1-1/4" # 5-1/2 (5)					
1/4" # 5/8 OH	Heavy Gauge Sections	1#	6#	R36-0480D	
1/2" OH #5-1/2	Regular Gauge Sections	1#	6#	R36-0521D	
9/16" OH #5-1/2	Heavy Gauge Sections	1#	6#	R36-0461D	
5/8" OH #5-1/2	Heavy Gauge Sections	1#	6#	R36-0462D	
15/16" OH #5-1/2	Head Rivet	1/2#	3#	R36-0522D	
1" OH #5-1/2	Head Rivet	1/2#	3#	R36-0465D	
1-1/4" OH #5-1/2	Head Rivet	1/2#	3#	R36-0467D	
1/2" CS #5-1/2	Section Rivet	1#	6#	R36-0464D	
5/8" CS #5-1/2	Section Rivet	1#	6#	R36-0463D	
1" CS #5-1/2	Head Rivet	1/2#	3#	R36-0466D	
1-1/4" CS #5-1/2	Guard Plate Rivet	1/2#	3#	R36-0468D	



AGCO-ALLIS 7, 80, 80R, 80R3, 80S, 80T, 82R, 82S, 82SH, 82T

OEM #	Length	No. Of Sections	Head	Head OEM #	Type	Section	Section OEM #	Bolted No	Price	Riveted No	Price
70804549	7'	28	H15-0306	70804519	XHUS	S20-5246	70802541	-		S35-3716	

AGCO-GLEANER A, C, E, F, G, K, L, M, MH,F2, K2, M2, R R40, R50, R52, R62, R70, R72, SERIES I & II RIGID, SERIES III FLEX, 300, 500 SERIES, 700 RIGID, 800 FLEX 1986-LATER

OEM #	Length	No. Of Sections	Head	Head OEM #	Type	Section	Section OEM #	Bolted No	Price	Riveted No	Price
SS71348716 71361507	16'	63	Headless	-	XH7TSCR	S20-4285	SS71135135	S35-2041		-	
SS71348720 71360498	20'	79	Headless	-	XH7TSCR	S20-4285	SS71135135	S35-2042		-	

AGCO-HART-CARTER FLOATING BAR , HART-CARTER GENERATION III, SERIES II F2, K2, L2, M2, N5, N6, N7 (WOBBLE DRIVE HD). Mounts on end of sickle.

OEM #	Length	No. Of Sections	Head	Head OEM #	Type	Section	Section OEM #	Bolted No	Price	Riveted No	Price
71307333	13'	53	H15-0194	71307323	XHTSCR	S20-4462	71176531	-	-	S35-4230	
71307335	16'	65	H15-0194	71307323	XHTSCR	S20-4462	71176531	-	-	S35-4232	
71307336	18'	73	H15-0194	71307323	XHTSCR	S20-4462	71176531	-	-	S35-4233	
71307337	20'	81	H15-0194	71307323	XHTSCR	S20-4462	71176531	-	-	S35-4234	
71307339	24'	97	H15-0194	71307323	XHTSCR	S20-4462	71176531	-	-	S35-4236	

SPLICED SICKLES AGCO-GLEANER F, L, M, MH, R, R40, R50, R52, R62, R70, R72 ALL WITH SERIES III FLEX, 300, 500, 700, 800 ALL SERIES I & II RIGID 1986-LATER

A = 8' Head End S35-2801	C = 7' Extension S35-2803
B = 4' Extension S35-2802	D = 8' Tail End S35-2804

OEM #	Length	No. Of Sections	Head	Type	Section	Section OEM #	A	B	C	D	Order No	Price
71348520	20'	79	Headless	XH7TSCR	S20-4285	SS71135135	1	1	0	1	S35-2806	
71348524	24'	95	Headless	XH7TSCR	S20-4285	SS71135135	1	2	0	1	S35-2807	
71348527	27'	107	Headless	XH7TSCR	S20-4285	SS71135135	1	1	1	1	S35-2808	
71348530	30'	119	Headless	XH7TSCR	S20-4285	SS71135135	1	0	2	1	S35-2809	

SPLICE KITS

Description	Application	Order No	Price
Bolts and nut for splice segment. 12 per package.	All Spliced Sickles	B55-0049D	
Splice kit 2" hole spacing. Kit contains 2 straps, bolts & nuts	Combines, Mowers & Mower Conditioners	C83-0750	



SICKLE HEADS & BEARING

OEM Number	Description	Application	Order No	Price
71307323	Sickle Head (Wobble Drive)	Combines, Floating Bar Generation 3 HC& Series 2	H15-0194	
71358960	Sickle Head	Combines, Series 3 Prior to S/N 19301	H15-0228	
	Silver Tiger Head	AC Series 3, 300, 400, 500, 700 & 800	H15-0433	
70804519	Head	Mowers, Model 7, 80	H15-0306	



HOLD DOWN CLIPS

NON-ADJUSTABLE

Description	Style	Application	Order No	Price
Steel	Low Arch	All Combines	C45-0063	
Cast	High Arch	Combines, Floating Bar - Series 2, HC I & II & III, Use on Drive Head	C45-0052	
Steel	Low Arch	Mowers, Rigid & Flex, Combine, Except Hart-Carter	C45-0692	
Steel	High Arch	Mowers, Rigid & Flex, Combine, Except Hart-Carter	C45-0693	



ADJUSTABLE

Description	Style	Application	Order No	Price
Cast	Low Arch	All Mowers & Mower Conditioners	C45-0006	
Cast	High Arch	All Mowers & Mower Conditioners	C45-0007	
Cast	Low Arch	Clip Only For C45-0006	C45-0008	
		Rubber Elastomer For C45-0006 & C45-0007	R36-0001	
Steel	Low Arch	Most Combines, Mowers, & Windrowers, Except Versatile, Hart-Carter, & Love	C45-0040	



6" WEAR PLATES

Replaces Number	Application	Order No	Price
W50	All Mowers	P44-0591	
W50	Display Pack Of 2	P44-0591D	
1116532	All Combines. 6-7/16"	P44-0472	
1176537	All Combines. 5-1/2"	P44-0417	



P44-0417

BALE COUNTER

Bale counter, reads up to 99,999. 4-hole mounting plate, push button reset, adjustable side arm. Fits most balers.

Order No	Price
T55-0002	



GRASS BOARD

Fits all mowers



Order No	Price
B52-0615	

GUARDS - MALLEABLE AND FORGED STEEL

OEM Number	Replaces Number	Description	Application	Order No	Price
70804072	DM 700	1 Prong-Malleable	Mowers 3, 4, 5, 7, 80	G81-0803	
70802500	DM 700R	1 Prong-Malleable, RH	All Mowers with 7/16" Bars.	G81-0805	
71116504	FC 68-2	2 Prong-Forged	Combines, Rigid Bar	G81-0187	
71341601	HA225A		Series A, C, E, R, T, G, F & N.		
71176532	FC 89-2	2 Prong-Forged	Combines, Floating Bar,	G81-0125	
71320143	HA231		All		
676295N	BU208H	2 Prong-Forged	Claas-Cat Challenger Combine	G81-0199	

G81-0803



G81-0125



G81-0199



PLASTIC BEARINGS AND HARDWARE FOR PIPE REEL KITS

Description	Order No	Price
Outside Tine Bracket. Use with T16-0730 to replace LH or RH original steel reel end fingers. Fits Herschel-Adams Reel Conversion Kits. Sold individually.	B65-0120	
Plastic Bearing Kit. Includes 6 caps, 6 bases, U-Bolts and 12 nuts. Application: Reels with Wood Bats used on AC Gleaner.	B15-0915	
Plastic Bearing Kit. Includes 12 bearing halves, 12 bolts, and 12 nuts. Application: Reels with Tear Drop Bats and Rear Mounted Plastic Tines used on AGCO Gleaner series 3 and 300.	B15-0920	
Plastic Bearing Kit. Includes 12 bearing halves, 6 bolts, and 6 nuts. Application: Pipe Reels with Plastic Tines used on AGCO 300, 400, 500, 700, & 800 series.	B15-0925	

B15-0915



B15-0925



B15-0920

REEL TINES



Replaces Number	Description	Application	Pkg. Qty.	Order No	Price
N66A	Reel Tine	AC Series 1 & 2	100	T16-0183	
N67A	Reel Tine Series 3	Deutz-Allis OEM #71345318	100	T16-0767	
1127204	Reel Tine, 1 Prong, Steel	Used on Hume Reels.	Each	T16-0124	
782551, 1989438C1, AH136689, AH153175	2 pc. M/L Reel Tine w/clamps	Most Combines w/pipe reels	100	T16-0720	
782226, 1989438C1, AH136689, AH153175	2 pc. M/L Reel Tine w/clamps	Most Combines w/pipe reels	10	T16-0715	
HA100MLT	M/L Reel Tine Only, less clamps	For T16-0720 & T16-0715	100	T16-0725	
HA20SC	Replacement Screw	For T16-0720 & T16-0715	20	B55-0096D	

HERSCHEL 6" 2-PIECE POLY TINES FOR PIPE REELS

Fits 700, 800, 7000 & 8000 Series

- PATENTED 2 PIECE DESIGN.
- SAVE MONEY! REPLACE ONLY THE TINE.

Description	Pkg. Qty.	Order No	Price
Tine & Clamp	100/Box	T16-0740	
Tine & Clamp	10/Box	T16-0745	
Tine ONLY	100/Box	T16-0750	



PICKUP TOOTH

2 Prong, Plastic

Order No	Price
T16-0050	

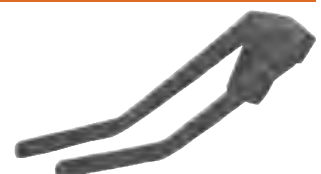

POLY SKID SHOE KITS FOR COMBINES

- 1/4" ultra high molecular weight Polyethylene(UHMW) material is super slick and lightweight.
- The abrasion resistance of this plastic is 1.8 times greater than steel.
- Has nearly the exact same "sliding" properties as Teflon.
- Prevents losing valuable harvest days due to wet weather.
- Allows you to harvest in wet conditions or clay with no sticky build-up.
- Easy to install, just drill holes in steel plates and fasten with Hammer rivets furnished in all kits.
- Precut and formed. All Plates come with countersunk drilled holes.
- Protects your metal skid shoes so they never wear out.
- Furnished with end plate, wobblebox plate.

Replacement Parts Available!
Call Customer Service at 1-800-247-2167

Sickle

Size	Application	Color	Order No	Price
15', 16'	Duetz-Allis Series I	White	P44-1090	
18'	Duetz-Allis Series II	White	P44-1091	
20'	Duetz-Allis Series II	White	P44-1092	
15'	86 & Later AC Series 3, 500 & 800	Silver	P44-1115	
20'	86 & Later AC Series 3, 500 & 800	Silver	P44-1117	
15'	87 & Newer AC Series 3, 500 & 800	Silver	P44-1410	
18'	87 & Newer AC Series 3, 500 & 800	Silver	P44-1411	
20'	87 & Newer AC Series 3, 500 & 800	Silver	P44-1412	
22'	87 & Newer AC Series 3, 500 & 800	Silver	P44-1414	
25'	87 & Newer AC Series 3, 500 & 800	Silver	P44-1415	
30'	87 & Newer AC Series 3, 500 & 800	Silver	P44-1416	

POLY REPLACEMENT PARTS FOR HERSHEY SPECKLED POLY KITS

Replaces Number	Size L X W	Rivets Req.	Quantity Required 13' 15' 16' 18' 20' 24'	Order No	Price
Duetz-Allis - Series 2					
HC3-18	7" X 18"	8	3 4 4 5 6 8	P44-1121	
HC3-33	7" X 33"	12	1 1 1 1 1 1	P44-1122	
HC3-44	7" X 44"	16	1 1 1 1 1 1	P44-1123	

Allis Chalmers / Duetz-Allis - Series 3, 300 Flex (through 1986)

AC3-EP	24" x 5"	4	1 1 1 1 1 1	P44-1205	
AC3-DP	24" x 12"	6	1 1 1 1 1 1	P44-1206	
AC3-115	14" x 11 1/2"	6	2 2	P44-1207	
AC3-175	14" x 17 1/2"	8	1 1 1 1 3 3	P44-1208	
AC3-235	14" x 23 1/2"	10	2 2	P44-1209	
AC3-295	14" x 29 1/2"	12	2 2 2	P44-1210	
AC3-36	14" x 36"	14	2 2 4 4 2 4	P44-1211	

Allis Chalmers / Duetz-Allis - Series 3, 300 Headers (1987 and newer)

AC3N-11.5	14" x 11-1/2"	6	2 2	P44-1401	
AC3N-17.5	14" x 17-1/2"	8	1 1 1 1 3 3	P44-1402	
AC3N-23.5	14" x 23-1/2"	10	2 2	P44-1403	
AC3N-29.5	14" x 29-1/2"	12	2 2 2	P44-1404	
AC3N-35.5	14" x 35-1/2"	14	1 1 3 3 1 2	P44-1405	
AC3N-37	13" x 37"	14	1 1 1 1 1 1	P44-1407	
AC3N-40	13" x 40"	16		1	P44-1408
AC3N-DP	24" x 11"	7	1 1 1 1 1 1	P44-1420	
AC3N-EP	25" x 5"	5	1 1 1 1 1 1	P44-1421	

Please specify if your flex head is 1987 or newer when ordering.

HAMMER RIVETS AND TOOL

Size	Description	Application	Qty	Pkg Order No	Price
3/16" x 5/16"	Small Head	IH 1020 (1994 & Before)	50/BB	R36-0652	
3/16" x 5/16"	Large Head	IH 820, HC III	50/BB	R36-0655	
	Hammer Rivet Tool for Drive Rivets			T55-0812	



IDLER PULLEYS BY AETNA

OEM Number	Style	Outer Diam.	Center Hole	Overall Width	Order No	Price
70539528	Flat Face	2-3/4"	1/2"	1-1/2"	P83-0609	
71160426	Single Flange w/Seal Protector	3-1/2"	1/2"	1-1/2"	P83-0600	
71174568	Flat Flanged	5-3/4"	5/8"	1-3/4"	P83-0602	
71145679	Flat Flanged	5-3/4"	5/8"	2-1/8"	P83-0603	

STRAW CHOPPER KNIFE KITS

For Gleaner Combines
 Replaces OEM 71310275

Set Includes	Size Width x Length	Order No	Price
3 Knives 3 Bushings 3 Bolts 3 Nuts	4-5/8" X 6-7/16"	C83-0601	



CORN HEAD GATHERING CHAINS

- Individually boxed • Top quality chain for long life
- Made in U.S.A.



OEM Number	Chain Type	Flight Style	Offset Links	Conn. Links	Total Links	Application	Order No	Price
70574793	CA550	C17E	1	1	57	All Models 1977 & Up	C30-0085	
71505705	CA550	C17E	Continuous		50	Hugger Corn Heads	C30-0084	

GATHERING CHAIN DRIVE SPROCKET

For AGCO Hugger Heads & 3000 Series 8 Tooth
 Replaces OEM 71391292

Order No	Price
S62-0726	

GATHERING CHAIN IDLER SPROCKETS



OEM Number	Description	Application	Order No	Price
70595084	Lower idler sprocket, Sealed, 8 tooth, 5/8" hole	Black adjustable row heads, 1977 to 1989	S62-0740	
71359125	Lower idler sprocket, Regreasable, 8 tooth, 5/8" hole	All hugger corn heads	S62-0815	

CORN HEAD KNIVES

Orange, low profile, Quick switch heads, 1972 to 1976. Black adjust. row heads, 1977 to 1989. 4 used per roll, 8/row.

OEM Number	Description	Order No	Price
70586591	Snapping Roll Flute	B45-0058	



A	
Auger Fingers	23
Auger Repair Tool	23
B	
Bale Counter	22
Bearings, Plastic Reel	22
Board, Grass	22
Bolt-N-Clip Kit	16
Bolts, Guard	22
Bolts, Section	16
C	
Chains, Gathering	24
Clips, Hold Down	21
Combine Cutterbar Replacement Kits	20
Combine Teeth	22
D	
Disc Mower Knives	20
E	
End Sections	15
G	
Gathering Chain	24
Gathering Chain Sprockets	24
Grass Board	22
Guard Bolts	22
Guards, Case	21
Guards, Case I.H.	21
H	
Hammer Rivets	23
Hammer Rivet Tool	23
Head Socket Assemblies	20
Hold Down Clips	21
K	
Kit, Bolt-N-Clip	16
Kits, Combine Cutterbar Replacement	20
Kits, Polly Skid Shoe	23
Kits, Spliced	20
O	
Overlap Sections	16

P	
Pick-Up Teeth	22
Plastic Reel Bearings	22
Plastic Tines	22
Poly Replacement Parts	23
Poly Skid Shoe Kits	23
R	
Rake Teeth	22
Reel Tines	22
Replacement Parts, Poly	23
Rivets, Hammer	23
Rivets, Section	16
S	
Sections	15
Section Bolts	16
Section Rivets	16
Sickle Heads	20
Sickles	17 - 19
Skid Shoe Kits	23
Spliced Sickles	20
Spring Teeth	22
Sprockets, Gathering Chain	24
T	
Teeth, Combine	22
Teeth, Pick-up	22
Teeth, Rake	22
Teeth, Reel	22
Teeth, Spring	22
Tines, Reel	22
Tooth, Rake	22
Tru-Tube Tool	23
W	
Wear Plate	22

SECTION TYPE ABBREVIATIONS

Section Finish	Section Type	Section Thickness
CR = Chrome	7TS = Super 7 Top Serrated SM = Smooth US = Under Serrated TS = Top Serrated TT = Tiger Tooth TJ = Tiger Jaw SRK = Tiger Shark	XH = Extra Heavy .116"

CASE

Application	OEM #	Size	Description	Section Design	Rivet Used	Pkg. Qty	Order No	Price
All Mowers & Windrowers	049213	3x3-1/4	XHTSCR	B	1/2 OH	10	S20-4013	
All Mowers & Windrowers	049254	3x3-1/4	XHTSCR	B	9/16 OH	10	S20-4564	
All with Tiger Tooth Sickles	TT049254	3x3-1/4	XHTTCR	R	5/8 OH	10	S20-4464	



CASE-IH

Application	OEM #	Size	Description	Section Design	Rivet/Bolt Used	Pkg. Qty	Order No	Price
All Hart-Carter Combines Floating Bar	179736C3	3x2-1/2	XHTSCR	H	5/8 CS	10	S20-4462	
All Hart-Carter Combines Floating Bar	277444	3x2-1/2	XH7TSCR	H+	5/8 CS	10	S20-4322	
All Mowers, Windrowers, MC	MB333	3x2-1/2	XHSM		1/2 OH	10	S20-1144	
All Mowers, Windrowers, MC	826723C1	3x3-1/4	XHUS	B-	1/2 OH	10	S20-5244	
All Mowers, Windrowers, MC	MC333	3x3-1/4	XHTS	B	1/2 OH	10	S20-3412	
All Mowers, Windrowers, MC	826724C1	3x3-1/4	XHSM		9/16 OH	10	S20-1145	
All Mowers, Windrowers, MC	826722C2	3x3-1/4	XHUS	B-	9/16 OH	10	S20-5107	
All Mowers, Windrowers, MC	457605R2	3x3-1/4	XHSMCR		9/16 OH	10	S20-2758	
All Mowers, Windrowers, MC	457606R2	3x3-1/4	XHUSCR	B-	1/2 OH	10	S20-6332	
All Mowers, Windrowers, MC	457607R3	3x3-1/4	XHUSCR	B-	9/16 OH	10	S20-6339	
Combine 810 Rigid Header	634794R2	3x2-31/32	XHTSCR		9/16 OH	10	S20-4681	
Double Drive Sickle Overlap	TS635161	3x3-1/4	XH7TSCR	B+	9/16 OH	10	S20-4309	
Double Drive Sickle Overlap	TS635161	3x3-1/4	XHTSCR	B	9/16 OH	10	S20-4371	
End Section RH	700705462		XHTSCR	B	9/16 OH	10	S20-4210	
End Section LH	700705463		XHTSCR	B	9/16 OH	10	S20-4211	
Smooth. 1 used on head end.						10	S20-0297	



Used To Replace OEM Numbers Listed Below

Mowers & Conditioners 820, 1010, 1020, 2010, 2020 Headers	826720C2, 9622744, 86615988	3x3-1/4	Tiger Shark™	3-Hole	9/16 OH	10	S20-8268	
	112074A1, 86616588, 86616691	3x3-1/4	XH7TS	B+	9/16 OH	10	S20-3325	
	191256A1, 86616689	3x3-1/4	XH7TSCR	B+	9/16 OH	10	S20-4268	
	700705300, 86616527, 826720C2, 112074A1	3x3-1/4	XHTSCR	B	5/8 OH	10	S20-4277	
		3x3-1/4	XH7TS, 3 hole	B+	9/16 OH	10	S20-3482	

Used To Replace OEM Numbers Listed Below

Combine Headers 1042, 1052, 2042, 2052, 2062, 2142, 2152, 2162	87422066, 1327448C1, 84342590	3x3-1/4	Tiger Shark™	C+		10	S20-8398	
		3x3-1/4	XH7TSCR	C+		10	S20-4398	
		3x3-1/4	XHTS	C		10	S20-3283	
		3x3-1/4	XHTSCR	C		10	S20-4170	

Used To Replace OEM Numbers Listed Below

3020, 3162, 3152, NH740CH, NH880CF	87728905	3x3-1/4	Tiger Shark™	C+		10	S20-8549	
			XH7TS	B+		10	S20-3549	

*Half Section

TIGER JAWS® AND 1-1/2 IH SYSTEM SECTIONS

Replaces Number	Size	Description	Application	Rivet Used	Pkg. Qty	Order No	Price
TJ7000	3 x 3-1/4	XH TJ CR	Combines w/ Tiger Jaws	TJ55BN	10	S20-4639	
SSTJ7000	3 x 3-1/4	XH 7TJ CR	Combine w/ Tiger Jaws	TJ55BN	10	S20-4317	
1970390C2	3 x 3	XH 7TT	Combine 1020 w/1-1/2 cut (IH)	TJ50BN	10	S20-3120	



UNIVERSAL END SECTIONS

HERSCHEL "End Sections" are made of one-piece high carbon, heat-treated steel for rugged use. They are punched with an oblong hole to virtually fit any standard cutterbar mower in use today. To install our "End Section", simply take off the last section on the shoe end of your sickle assembly and replace it with an "End Section". The change-over takes only a couple of minutes to complete and you will notice a big difference in time saved from unclogging your mower. We recommend using a R36-0523D oval head rivets or B55-0065D Bolts.

Description	Order No	Price	Description	Order No	Price
XH7TSCR (RH) 10/Box	S20-4403		XHTS CR (RH) 2/SP	S20-4210D	
XH7TSCR (RH) 2/SP	S20-4403D		XHTSCR (LH) 10/Box	S20-4211	
XH7TSCR (LH) 10/Box	S20-4445		XHTSCR (LH) 2/SP	S20-4211D	
XH7TSCR (LH) 2/SP	S20-4445D		XHUSCR (RH) 10/Box	S20-6640	
XHTS CR (RH) 10/Box	S20-4210		XHUSCR (RH) 2/SP	S20-6640D	



SECTION BOLTS

- Quick and easy section changes are possible with bolts.
- No more cutting, chiseling, or grinding - simply unbolt the section, replace and tighten bolts.
- Bolts will not turn in Knife Back and are reusable. They will last thru the life of several sections.
- Bolts may be replaced easily if accidentally damaged or broken.
- No special tools are needed to change sections, only a 7/16 wrench or socket.
- Bolt and nuts hold better than rivets and they have a greater clamp load than rivets.
- Special lock nuts will not vibrate loose.

Description	Application	Pkg.	Qty.		Order No	Price
			Mst Ctn.			
Section Bolt w/nut	Universal - Replaces 9/16 & 5/8 OH Rivets	50	300		B55-0065D	
Head Bolt w/nut	Universal - Replaces 1-1/2 & 1-1/16 OH Rivets	15	90		B55-0085D	
Head Bolt w/nut	Universal - Replaces 1-1/2 OH Rivets	12	72		B55-0095D	
Section Bolt w/nut	Case I-H Combines 1010 & 1020, 1-1/2 System**. Oval Head.	20	120		B55-0050D	
Head Bolt w/nut	Case I-H Combines 1010 & 1020, 1-1/2 System**. Oval Head.	16	96		B55-0060D	
Section Bolt w/nut	Universal Bolts for 10' Sickle w/Head Bolts (80-B55-0065D, 5-B55-0085D, 5-B55-0095)	90	Each		B55-0500D	
Overlap Bolt w/Low Profile Nut*	Double Drive Sickles, replaces 1/2 CS rivets 60° Head	10	60		B55-0059D	
Section Bolt*	Versatile, Countersink, replaces 9/16 CS rivets	20	120		B55-0056D	
Section Bolt*	Love & Hart Carter, Countersink, replaces 5/8 CS rivets. 60° Head	20	120		B55-0057D	
Head Bolt*	Love, Hart Carter & Versatile, Countersink, replaces 1 CS rivets	10	6		B55-0058D	
Nut	Universal-Used on all the above bolts except B55-0050D	20	120		N83-0289D	

* Use with Allen Wrench ** Requires IH Hold Down OEM#132074663



SECTION RIVETS - ZINC PLATED

OH = Oval Head CS = Counter Sunk

Size/No. in Pkg.	Application	Qty. Pkg.	Mstr. Ctn.	Order No	Price
1" # 5-1/2 (10)	and Knife Heads				
5/8" # 5-1/2 (72)	Mower Conditioners	Asst.	6	R36-0524D	
1" # 5-1/2 (5)					
1-1/4" # 5-1/2 (5)					
1/4" # 5/8 OH	Heavy Gauge Sections	1#	6#	R36-0480D	
1/2" OH #5-1/2	Regular Gauge Sections	1#	6#	R36-0521D	
9/16" OH #5-1/2	Heavy Gauge Sections	1#	6#	R36-0461D	
5/8" OH #5-1/2	Heavy Gauge Sections	1#	6#	R36-0462D	
15/16" OH #5-1/2	Head Rivet	1/2#	3#	R36-0522D	
1" OH #5-1/2	Head Rivet	1/2#	3#	R36-0465D	
1-1/4" OH #5-1/2	Head Rivet	1/2#	3#	R36-0467D	
1/2" CS #5-1/2	Section Rivet	1#	6#	R36-0464D	
5/8" CS #5-1/2	Section Rivet	1#	6#	R36-0463D	
1" CS #5-1/2	Head Rivet	1/2#	3#	R36-0466D	
1-1/4" CS #5-1/2	Guard Plate Rivet	1/2#	3#	R36-0468D	



OVERLAP SECTION KIT

For 8380 & 8840

Contains: (5) S20-4371 - XH TS CR Sections, (3 RH & 2 LH) Btm. CTSK Sections, (10) B55-0059 - CTSK Bolts & Nuts.

Order No S20-4003

KNIFE CLIP

For CNH 2162 Double Drive Head.
Fits 42, 52, 62 Series Headers.
Replaces 87458207



Order No C45-0050

BOLT-N-CLIP KIT

Why bolts are better than rivets:

- Bolts will not turn in Knife Back and are reusable.
- They will last thru the life of several sections.
- Bolts may be replaced easily if accidentally damaged or broken.
- No special tools are needed to change sections, only a 7/16 wrench or socket.
- Bolts and nuts hold better than rivets. They have a greater clamp load than rivets.



Size	Description	Application	Order No	Price
10' Bar	Includes 9 Low Arch Clips, 1 High Arch Clip, Bolts & Nuts to do a 10' Bar	Most Mowers, M/C, & Combines	B55-0629	

**ORDER ONLINE
24-HOURS A DAY,
7 DAYS A WEEK.**

HERSHELPARTS.COM

CASE RIVETED SICKLE ASSEMBLIES

MOWER CONDITIONER 555

OEM #	Length	No. Of Sections	Head	Head OEM #	Type	Section	Section OEM #	Riveted Order No	Riveted Price	Bolted Order No	Price
451955HD	9'	38	H15-0880	451948HD	XHTSCR	S20-4013	049213	S35-4594		-	
6566178HD	9'	38	H15-0880	451948HD	XHTSCR	S20-4564	049254	S35-4060		-	

WINDROWERS 950, 955, 1050, 1055, 1150, 1155

OEM #	Length	No. Of Sections	Head	Head OEM #	Type	Section	Section OEM #	Riveted Order No	Riveted Price	Bolted Order No	Price
6566178HD	9'	38	H15-0880	451948HD	XHTSCR	S20-4564	049254	-		S35-2359	

CASE IH SICKLES

MOWER SERIES 100 BALANCED HEAD 1000 SERIES, 1100, 1300 PIN TYPE

OEM #	Length	No. Of Sections	Head	Head OEM #	Type	Section	Section OEM #	Riveted Order No	Riveted Price	Bolted Order No	Price
462381R93	7'	28	H15-0281	56692C91	XHSM Tiger Shark™	S20-1145	826724C1 S20-8268	S35-3668		- S35-2500	
462380R93	7'	28	H15-0281	56692C91	XHUS	S20-5107	826722C1, 826722C2	S35-3667		S35-1281	
SS1281292C92	7'	28	H15-0281	56692C91	XH7TS	S20-3325	112074A1	-		S35-1032	
1281292C92	7'	28	H15-0281	56692C91	XHTS	S20-3276	826720C2	S35-3939		-	
1281291C92	9'	35	H15-0281	56692C91	XHTS	S20-3276	826720C2	S35-3940		S35-1103	
463182R93	9'	35	H15-0281	56692C91	XHSM	S20-1145	826724C1	S35-3672		-	
463159R93	9'	35	H15-0281	56692C91	XHUS Tiger Shark™	S20-5107	826722C1, 826722C2	S35-3669		S35-1714 S35-2512	
SS1281291C92	9'	35	H15-0281	56692C91	XH7TS	S20-3325	112074A1	S35-3012		S35-1033	

ALL MOWER MODELS EXCEPT SERIES 100 BALANCED HEAD (OLD BALL HEAD)

OEM #	Length	No. Of Sections	Head	Head OEM #	Type	Section	Section OEM #	Riveted Order No	Riveted Price	Bolted Order No	Price
1958206C1	6'	24	H15-0257	MA999	XHUS	S20-5107	826722C1, 826722C2	S35-3629		-	
1958205C1	7'	28	H15-0257	MA999	Tiger Shark™	S20-8268				S35-1131	
1958207C1	7'	28	H15-0257	MA999	XHUS	S20-5107	826722C1, 826722C2	S35-3630		S35-1282	
SS1958207C1	7'	28	H15-0257	MA999	XH7TS	S20-3325	112074A1	S35-3631		S35-1031	
1958203C1, MB409	7'	28	H15-0257	MA999	XHSM	S20-1145	826724C1	S35-3543		-	
463294R91	9'	36	H15-0257	MA999	XHUS	S20-5107	826722C1, 826722C2	S35-3304		-	
1958207C1	7'	28	H15-0257	MA999	XHUS	S20-5244	826723C1	S35-3623		-	
1958206C1	6'	24	H15-0257	MA999	XHSM			S35-3537		-	
SS463294R51	9'	36	H15-0257	MA999	XH7TS	S20-3325	112074A1	S35-1097		-	

MOWER CONDITIONER 990

OEM #	Length	No. Of Sections	Head	Head OEM #	Type	Section	Section OEM #	Riveted Order No	Riveted Price	Bolted Order No	Price
542816R91, 542816R92	7'	28	H15-0131	540607R11	XHUS	S20-5107	826722C1, 826722C2	S35-3132		-	
540605R91, 540605R92	9'	36	H15-0131	540607R11	XHUS Tiger Shark™	S20-5107	826722C1, 826722C2	S35-3133		S35-1715 S35-2559	

WINDROWERS 75 PULL TYPE

OEM #	Length	No. Of Sections	Head	Head OEM #	Type	Section	Section OEM #	Riveted Order No	Riveted Price	Bolted Order No	Price
824874C91	18'	72	Headless	-	XHUSCR	S20-6332	457606R2	S35-4069		-	
824875C91	21'	84	Headless	-	XHUSCR	S20-6332	457606R2	S35-4070		-	
825821C91	21'	84	Headless	-	XHTSCR	S20-4277	596321R3	-		S35-2288	

MOWER 1190

OEM #	Length	No. Of Sections	Head	Head OEM #	Type	Section	Section OEM #	Riveted Order No	Riveted Price	Bolted Order No	Price
101987C95	7'	29	H15-0283	824594C91	XHUS	S20-5107	826722C1, 826722C2	S35-3293		-	
101988C95	9'	37	H15-0283	824594C91	XHUS Tiger Shark™	S20-5107	826722C1, 826722C2	S35-3292		S35-1716 S35-2514	
SSTT101988C95	9'	37			XH7TJCR	S20-4317	SSTJ7000	-		S35-2360	

WINDROWERS 230, 4000, 5000 ALL WITH SINGLE AUGER OR DRAPER HEADER, 210 S/N 3700-LATER

OEM #	Length	No. Of Sections	Head	Head OEM #	Type	Section	Section OEM #	Riveted Order No	Riveted Price	Bolted Order No	Price
827813C92	12.5'	49	H15-0283	824594C91	XHUSCR	S20-6339	457607R3	S35-4288	-	-	-
827814C92	14.5'	57	H15-0283	824594C91	XHUSCR	S20-6339	457607R3	S35-4289	-	S35-2717	-
831607C94	14.5'	57	H15-0283	824594C91	XHTSCR	S20-4277	596321R3	S35-4184	-	S35-2295	-
824705C94	14.5'	57	-	-	XHTJCR	S20-4317	SSTJ7000	-	-	S35-2378	-
827815C92	16.5'	64	H15-0283	824594C91	XHUSCR	S20-6339	457607R3	S35-4290	-	-	-
1281480C92	16.5'	64	H15-0283	824594C91	XHTSCR	S20-4277	596321R3	-	-	S35-2296	-
827816C92	19.5'	76	H15-0283	824594C91	XHUSCR	S20-6339	457607R3	S35-4291	-	-	-
1281481C92	19.5'	76	H15-0283	824594C91	XHTSCR	S20-4277	596321R3	-	-	S35-2297	-

WINDROWERS 4000, 5000, 5500 ALL WITH DUAL AUGER HEADER

OEM #	Length	No. Of Sections	Head	Head OEM #	Type	Section	Section OEM #	Riveted Order No	Riveted Price	Bolted Order No	Price
827701C92	14'	56	H15-0283	824594C91	XHTSCR	S20-4277	596321R3	-	-	S35-2587	-

WINDROWERS 721, 725, 730, 736, 742, 750, 6000, 6500

OEM #	Length	No. Of Sections	Head	Head OEM #	Type	Section	Section OEM #	Riveted Order No	Riveted Price	Bolted Order No	Price
1337024C1, 90966C91	21'	83	Headless	-	XHTSCR	S20-4277	596321R3	S35-4025	-	-	-
1969140C1 80648C91	25'	99	Headless	-	XHTSCR	S20-4277	596321R3	S35-4026	-	-	-
1969141C1, 80650C91	30'	119	Headless	-	XHTSCR	S20-4277	596321R3	S35-4027	-	-	-
	42'	166	Headless	-	XHTSCR	S20-4277	596321R3	(2)S35-4025	-	-	-
	50'	198	Headless	-	XHTSCR	S20-4277	596321R3	(2)S35-4026	-	-	-

WINDROWERS 6500, 7000 WITH SINGLE DRIVE AUGER HEADER

OEM #	Length	No. Of Sections	Head	Head OEM #	Type	Section	Section OEM #	Riveted Order No	Riveted Price	Bolted Order No	Price
33704	18'	71	Headless	-	XHTSCR	S20-4398	SS34390CR	-	-	S35-2262	-
43074, 338616A1	21'	83	Headless	-	XHTSCR	S20-4398	SS34390CR	-	-	S35-2253	-
43076	4'	16	Headless	-	XHTSCR	S20-4398	SS34390CR	-	-	S35-2254	-
	use w/ S35-2253										
43077	9'	36	Headless	-	XHTSCR	S20-4398	SS34390CR	-	-	S35-2255	-
	use w/ S35-2253										

WINDROWERS 8820 SINGLE AUGER HEADER

OEM #	Length	No. Of Sections	Head	Head OEM #	Type	Section	Section OEM #	Riveted Order No	Riveted Price	Bolted Order No	Price
700709577	7' LH	25	H15-0390	6821078	XHTSCR	S20-4564	700705300	S35-4390	-	-	-
700709578	7' RH	25	H15-0301	6821136	XHTSCR	S20-4564	700705300	S35-4391	-	-	-
700709579	8' LH	29	H15-0390	6821078	XHTSCR	S20-4564	700705300	S35-4388	-	-	-
700709580	8' RH	29	H15-0301	6821136	XHTSCR	S20-4564	700705300	S35-4389	-	-	-

MOWER, MOWER/CONDITIONER 1490, 1590

OEM #	Length	No. Of Sections	Head	Head OEM #	Type	Section	Section OEM #	Riveted Order No	Riveted Price	Bolted Order No	Price
143806C92, ZA502889	12'	49	H15-0292	ZA502562	XHUSCR	S20-6339	457607R3	-	-	S35-2293	-
143807C92, ZA502890	14'	57	H15-0292	ZA502562	XHUSCR	S20-6339	457607R3	-	-	S35-2294	-

MOWER/CONDITIONER 8380, 8840, 8870 WITH 625 AUGER HEADER, SC414DLX, SC416DLX

OEM #	Length	No. Of Sections	Head	Head OEM #	Type	Section	Section OEM #	Riveted Order No	Riveted Price	Bolted Order No	Price
SS700114590	7' LH	28	H15-0063	700114594	XHTSCR	S20-4268	SS596321R3	-	-	S35-2001	-
SS700709581	7' LH	28	Headless	-	XHTSCR	S20-4268	SS596321R3	-	-	S35-2003	-
SS700114591	7' RH	28	H15-0063	700114594	XHTSCR	S20-4268	SS596321R3	-	-	S35-2002	-
SS700709582	7' RH	28	Headless	-	XHTSCR	S20-4268	SS596321R3	-	-	S35-2004	-
700715165	7' LH	28	H15-0063	700114594	XHTSCR	S20-4277	596321R3	-	-	S35-2067	-
700709581	7' LH	28	Headless	-	XHTSCR	S20-4277	596321R3	-	-	S35-2113	-
700715166	7' RH	28	H15-0063	700114594	XHTSCR	S20-4277	596321R3	-	-	S35-2068	-
700709582	7' RH	28	Headless	-	XHTSCR	S20-4277	596321R3	-	-	S35-2114	-
SS700114592	8' LH	32	H15-0063	700114594	XHTSCR	S20-4268	SS596321R3	-	-	S35-2014	-
					Tiger Shark™	S20-8268				S35-2528	
SS700709585	8' LH	32	Headless	-	XHTSCR	S20-4268	SS596321R3	-	-	S35-2017	-
SS700114593	8' RH	32	H15-0063	700114594	XHTSCR	S20-4268	SS596321R3	-	-	S35-2015	-
					Tiger Shark™	S20-8268				S35-2532	
SS700709586	8' RH	32	Headless	-	XHTSCR	S20-4268	SS596321R3	-	-	S35-2016	-
700715167	8' LH	32	H15-0063	700114594	XHTSCR	S20-4277	596321R3	-	-	S35-2069	-
700114894	8' LH	32	Headless	-	XHTSCR	S20-4277	596321R3	-	-	S35-2111	-
700715168	8' RH	32	H15-0063	700114594	XHTSCR	S20-4277	596321R3	-	-	S35-2070	-
700715168	8' RH	32	Headless	-	XHTSCR	S20-4277	596321R3	-	-	S35-2112	-
SS700715778	9' LH	36	H15-0063	700114594	XHTSCR	S20-4268	SS596321R3	-	-	S35-2305	-
SS700715778	9' LH	36	Headless	-	XHTSCR	S20-4268	SS596321R3	-	-	S35-2306	-
SS700715779	9' RH	37	H15-0063	700114594	XHTSCR	S20-4268	SS596321R3	-	-	S35-2309	-
SS700715779	9' RH	37	Headless	-	XHTSCR	S20-4268	SS596321R3	-	-	S35-2310	-
700715778	9' LH	36	H15-0063	700114594	XHTSCR	S20-4277	596321R3	-	-	S35-2307	-
700715778	9' LH	36	Headless	-	XHTSCR	S20-4277	596321R3	-	-	S35-2308	-
700715779	9' RH	37	H15-0063	700114594	XHTSCR	S20-4277	596321R3	-	-	S35-2311	-
700715779	9' RH	37	Headless	-	XHTSCR	S20-4277	596321R3	-	-	S35-2312	-

MOWER/CONDITIONER 8380, 8840, 8870 WITH 625 AUGER HEADER

OEM #	Length	No. Of Sections	Head	Head OEM #	Type	Section	Section OEM #	Riveted Order No	Riveted Price	Bolted Order No	Price
700114590	7' LH	28	H15-0063	700114594	Tiger Shark™	S20-8268		-		S35-2517	
700114591	7' RH	28	H15-0063	700114594	Tiger Shark™	S20-8268		-		S35-2519	

MOWER/CONDITIONER 8340

OEM #	Length	No. Of Sections	Head	Head OEM #	Type	Section	Section OEM #	Riveted Order No	Riveted Price	Bolted Order No	Price
700118673	9'	37	H15-0066	700111003	XHTSCR	S20-4277	596321R3	-		S35-2071	

MOWER/CONDITIONER 8360, 8370, 8830, SC412, SC414 CENTER PIVOT WITH 425 HEADER

OEM #	Length	No. Of Sections	Head	Head OEM #	Type	Section	Section OEM #	Riveted Order No	Riveted Price	Bolted Order No	Price
700110730, 700709622	12'	48	H15-0066	700111003	XHTSCR	S20-4277	596321R3	-		S35-2072	
700110731, 700709623	14'	56	H15-0066	700111003	XHTSCR	S20-4277	596321R3	-		S35-2073	

MOWER/CONDITIONER 8320, 8330, 8350

OEM #	Length	No. Of Sections	Head	Head OEM #	Type	Section	Section OEM #	Riveted Order No	Riveted Price	Bolted Order No	Price
700709587, 700712775	7'	29	H15-0390	6821078	XHTSCR	S20-4277	596321R3	-		S35-2080	
700111430, 700711767	9'	37	H15-0390	6821078	XH7TSCR	S20-4268	SS596321R3	-		S35-2081	
700109341, 700709583	12'	48	H15-0390	6821078	XH7TSCR	S20-4268	SS596321R3	-		S35-2082	

810 FLOATING BAR WOBBLE HEAD S/N 26001-LATER, GENERATION III HART-CARTER

OEM #	Length	No. Of Sections	Head	Head OEM #	Type	Section	Section OEM #	Riveted Order No	Riveted Price	Bolted Order No	Price
180853C91	13'	53	H15-0194	180859C91	XHTSCR	S20-4462	179736C3	S35-4230		-	
180854C91	15'	61	H15-0194	180859C91	XHTSCR	S20-4462	179736C3	S35-4231		-	
180856C91	18'	73	H15-0194	180859C91	XHTSCR	S20-4462	179736C3	S35-4233		-	
180857C91	20'	81	H15-0194	180859C91	XHTSCR	S20-4462	179736C3	S35-4234		-	
180858C91	24'	97	H15-0194	180859C91	XHTSCR	S20-4462	179736C3	S35-4236		-	

COMBINE 820 HEADER - 3" CUT

OEM #	Length	No. Of Sections	Head	Head OEM #	Type	Section	Section OEM #	Riveted Order No	Riveted Price	Bolted Order No	Price
197463C91, 197463C93	15'	58	H15-0640	197230C91	XHTS	S20-3276	826720C2	-		S35-2115	
197466C91, 197466C93	20'	78	H15-0640	197230C91	XHTS	S20-3276	826720C2	-		S35-2117	

ALL MOWERS MA 999 HEADER & BALANCED HEAD, 990, 1190 M/C

OEM #	Length	No. Of Sections	Head	Head OEM #	Type	Section	Section OEM #	Riveted Order No	Riveted Price	Bolted Order No	Price
			Headless					-		S35-1038	
			Headless					-		S35-1039	

2142, 2152 RIGID DRAPER HEAD

For 30'

OEM #	Length	No. Of Sections	Head	Head OEM #	Type	Section	Section OEM #	Riveted Order No	Riveted Price	Bolted Order No	Price
124926	16' RH	35	Headless	-	XH7TSCR	S20-4398	SS34390CR			S35-2120	
124923	16' LH	31	Headless	-	XH7TSCR	S20-4398	SS34390CR			S35-2121	

2162 DOUBLE DRIVE GRAIN HEAD

For 30'

OEM #	Length	No. Of Sections	Head	Head OEM #	Type	Section	Section OEM #	Riveted Order No	Riveted Price	Bolted Order No	Price
	20' RH	79	Headless	-	XH7TSCR	S20-4398	SS34390CR			S35-2131	
	20.5' LH	81	Headless	-	XH7TSCR	S20-4398	SS34390CR			S35-2130	

SPliced SICKLES - COMPLETE

1010, 1020 HEADER 3" CUT - HEADLESS

OEM #	Length	# Of Sections	Section Type	Section	Section OEM #	A	B	C	D	Order No	Price
1307281C98	15'	58	XH7TS	S20-3325	112074A1	-	1	1	-	S35-1054	
1307282C98	17.5'	68	XH7TS	S20-3325	112074A1	-	1	-	2	S35-1053	
1307283C98	20'	78	XH7TS	S20-3325	112074A1	-	1	1	1	S35-1052	
1307284C98	22.5'	88	XH7TS	S20-3325	112074A1	-	1	2	-	S35-1051	
1307255C98	25'	98	XH7TS	S20-3325	112074A1	-	1	2	2	S35-1050	
1307286C98	30'	118	XH7TS	S20-3325	112074A1	-	1	3	-	S35-1049	

820 HEADER 3" CUT - HEADLESS

OEM #	Length	# Of Sections	Section Type	Section	Section OEM #	A	B	C	D	Order No	Price
SPL197463C93	15'	58	XH7TS	S20-3325	112074A1	1	-	2	-	S35-1048	
SPL197465C93	17.5'	68	XH7TS	S20-3325	112074A1	1	-	-	2	S35-1047	
SPL197466C93	20'	78	XH7TS	S20-3325	112074A1	1	-	1	1	S35-1046	
SPL197467C93	22.5'	88	XH7TS	S20-3325	112074A1	1	-	2	-	S35-1045	

SPliced SICKLES FOR 1010, 1020 HEADER WITH 3" CUT

*Ships Via UPS

TIGER SHARK

Size	Order No.	Price
20'	S35-2786	
22.5'	S35-2787	

A	= 7' Head End S35-1044
B	= 7.25' Head End S35-1043
C	= 7.5' S35-1042
D	= 5' S35-1041

SPLICE KITS FOR IH SPLICED SICKLES

Description	Order No	Price
Bolts & Nuts for C83-0755 Splice Kit.	B55-0049D	
MA330 Shoe Plate (Outer)		
M 1583 33 5/8" Pitman Wood		
M 22184 35 11/16" Pitman Wood		
MA 1577 Pitman Strap (Front)	C83-0755	
M 1578 Pitman Strap (Rear)		
MC 1579A Latch Fork Assembly		
558141R1 V-Belt 540 RPM		



COMBINE CUTTERBAR REPLACEMENT KITS

To replace original 3" Systems or to convert 1-1/2" Systems to 3" Systems.
 Kits Include: Guards, Stamped Steel Adjustable Hold Down Clips, Drive Head & UPS Shippable Spliced Sickle with Bolted Chrome Super 7 Sections. Kit does not include Stub Guard 1338269C1 or Crop Deflector 1326342C3.

CASE/IH 820 SERIES

Replaces Number	Description	Order No	Price
STS175IH820	17.5 Foot Kit	C83-0203	
STS20IH820	20 Foot Kit	C83-0204	
STS5IH820 & 1020	5 Foot Ext. Kit	C83-0205	

CASE/IH 1020 SERIES

Replaces Number	Description	Order No	Price
STS175IH1020	17.5 Foot Kit	C83-0206	
STS20IH1020	20 Foot Kit	C83-0207	
STS5IH820 & 1020	5 Foot Ext. Kit	C83-0205	

MISCELLANEOUS CUTTERBAR PARTS

Replaces Number	Description	Application	Order No	Price
IH 7	7' Sickle Back	Mowers Series 100	S35-6096	
IH 9	9' Sickle Back	Mowers Series 100	S35-6095	
MA330	Shoe Plate (Outer)	Mowers All	P44-0617	
M 1583	33 5/8" Pitman Wood	Mowers 9, 10 & BIG 6	P38-0530	
M 22184	35 11/16" Pitman Wood	Mowers Series 10, 16, 21, 24, 28	P38-0535	
MA 1577	Pitman Strap (Front)	Mowers	S78-0834	
M 1578	Pitman Strap (Rear)	All Automatic Pitmans	S78-0835	
MC 1579A	Latch Fork Assembly	All IHC automatic	L02-0723	
558141R1	V-Belt 540 RPM	100 1000 Series Mowers w/540 RPM PTO	B22-0558	



SICKLE HEADS AND BEARINGS

Replaces Number	Description	Application	Order No	Price
180859C91	Sickle Head	Combines Floating Bars; 810 Header Wobble Drive HC Gen III	H15-0194	
TT540607C91	Sickle Head	Mowers/Cond. 990 w/Tiger Tooth Sickle	H15-0679	
MA999	Sickle Head	Mowers All Except Balanced Head series 100	H15-0257	
462378R11	Sickle Head	Mowers w/Balanced Head Series 100	H15-0281	
56692C91				
540607C91	Sickle Head	Mower/Cond. 990	H15-0131	
178466C91	Sickle Head	Combine 810 Header Not Floating Bar	H15-0294	
197230C91	Sickle Head	Combine 820 Header, Riveted Sickles Only	H15-0295	
N/A	ST Head	IH 820 Silver Tiger	H15-0431	
824594C91	Sickle Head	Mower/Conditioner and Windrower 1190, 230, 4000 and 5000.	H15-0283	
824812C91				
ZA502562	Sickle Head	Mower/Cond. 1490, 1590	H15-0292	
1316161C94	Sickle Head	Combine 1010 & 1020 w/3" System or Tiger Jaw Systems	H15-0090	
	ST Head	IH 1020 Silver Tiger	H15-0432	
700111003	Head	8340, 8360, 8370 & 8830, Single Drive	H15-0066	
700114594	Head	8380 & 8840, Double Drive	H15-0063	
TJ197230C91	Sickle Head	IH 820 1-1/2" Cut & Tiger Jaw Sickles. Bolted Sickle.	H15-0640	
KP12A	Head Bearing & Snap Rings	IH 810 & 820, HC III; Fits H15-0294 Heads, H15-0295 Heads, H15-0194 Heads, H15-0640 Head	B15-0659B	
	Sickle Head	820 Bolted. 3" Cut Systems	H16-0640	

DISC MOWER KNIVES

OEM Number	Application	Length Inches	Hole Dia. Inches	Style	Shape	Bolt Order No	6 Blades Order No	Price	25 Blades Order No	Price
700712888	725, 8309, 8312, 8315, 8850, DC515	4.21	.717"	4	RH Twisted	B55-0344D	B45-6568D		B45-6568	
700712889		4.21	.717"	4	LH Twisted	B55-0344D	B45-6569D		B45-6569	
700711857		4.21	.728"	5	RH Twisted	B55-0342D	B45-6559D		B45-6559	
700711858		4.21	.728"	5	LH Twisted	B55-0342D	B45-6560D		B45-6560	
ZA526216	306, 307, 308, 3204, 3205, 3206.	4.72	.728"	5	LH Twisted	B55-0357D	B45-6992D		B45-6992	
ZA526215		4.72	.728"	5	RH Twisted	B55-0357D	B45-6993D		B45-6993	
113385A1	3204, 3205, 3206	4.76	.890"	5	RH Twisted	B55-0355D	B45-6563D		B45-6563	
113384A1		4.76	.890"	5	LH Twisted	B55-0355D	B45-6564D		B45-6564	
9847684	MD72, MD82, MD92, RD132, MDX71, MDX81, MDX91, RD162, DCX91, DCX101, DCS131, DCX161, RDX131, RDX161, RDX181	4.21	.9"	5	LH Twisted	N/A	B45-6721D		N/A	
9847683		4.21	.9"	5	RH Twisted	N/A	B45-6720D		N/A	
527749, 113385A1	18° Top Bevel. 3204, 3205, 3260, 3309	4.76"	.89"	5	LHTwisted	B55-0355D	B45-6576D		N/A	
527748, 113384A1	18° Top Bevel. 3204, 3205, 3260, 3309	4.76"	.89"	5	RHTwisted	B55-0355D	B45-6577D		N/A	
700715575, 700715576,	18° Bottom Bevel. 725, 8850, DC515, 8309, 8312, 8315	4.21"	.728"		LHTwisted	B55-0342D	B45-6572D		B45-6572	
86625673, 86625674	18° Bottom Bevel. 725, 8850, DC515, 8309, 8312, 8315	4.21"	.728"		RHTwisted	B55-0342D	B45-6573D		B45-6573	
	18° Top Bevel. 725, 8850, DC515, 8309, 8312, 8315	4.21"	.728"	5	LHTwisted	B55-0342D	B45-6725D		B45-6725	
	18° Top Bevel. 725, 8850, DC515, 8309, 8312, 8315	4.21"	.728"	5	RHTwisted	B55-0342D	B45-6726D		B45-6726	

HOLD DOWN CLIPS - ADJUSTABLE AND NON-ADJUSTABLE

CASE Style	Description	Application	Order No	Price
Steel, Adjustable	Low Arch	Most combines, windrowers, and mowers except Versatile, Hart-Carter, and Love	C45-0040	
Steel Clip	Low Arch	Windrowers All Using Guard No. 049239 (G81-0040)	C45-0692	
Steel Tie Plate	Low Arch	Windrowers All	C45-0500	
Steel Tie Plate	High Arch	Using Guard No. 049270 (G81-0085)		

CASE-IH Style	Description	Application	Order No	Price
Steel	Clip Hi-Arch, Non-Adjustable	810 Flex Combines Floating Bar	C45-0052	
Steel	Lo-Arch, Non-Adjustable	Bolted Sickles	C45-0692	
Steel	Hi-Arch, Non-Adjustable	Bolted Sickles with Head Clearance	C45-0693	
Cast	Lo-Arch, Non-Adjustable	Mowers	C45-0020	
Cast	Lo-Arch Clip, Adjustable	All Mowers, Windrowers, & Swathers	C45-0006	
Cast	Hi-Arch Clip, Adjustable	All Mowers, Windrowers, & Swathers	C45-0007	
Cast	Clip Arch Only, Low, Adjustable	All Mowers, Windrowers, & Swathers	C45-0008	
	Rubber Elastomer for Adj. Clip	Use with C45-0006 & C45-0007	R36-0001	
Steel	Lo-Arch, Adjustable, Stamped Steel	Most Combines, Mowers, & Windrowers Except Versatile, Hart-Cater, & Love	C45-0040	
Steel	Top Clip Only, Adjustable	1020 Series Platforms with 1-1/2" Systems	C45-0011	
Steel	Lo-Arch, Non-Adjustable	Windrowers w/guard G81-0120	C45-0502	
Steel	Clip Hi-Arch	Windrowers w/Guard No. G81-0120	C45-0503	
Steel	Lo-Arch, Adjustable Clip Kit	OEM IH 1020 1-1/2 Cut	C45-0012	



GUARDS

CASE

Replaces Number	Description	Application	Replaces OEM Number	Order No	Price
DM700	Center-Malleable	All Mowers	T27293	G81-0803	
FT 77-2	Two Piece Center-Forged (Tie Guard)	Windrowers 950, 955, 1050, 1055, 1150, 1155, 1275	049270	G81-0085	
HA260, FT77-2	2-Prong	JI Case	049270	G81-0085	

CASE-IH

Replaces Number	Description	Application	Replaces OEM Number	Order No	Price
FC 89-2, HA231	Two Prong-Forged	Combines Floating Bar All	232155-234006	G81-0125	
FS 73-2, HA235	Two Prong	75 Windrowers	D8420S, K8420S	G81-0070	
FS 85-2, HA210	Two Prong (No Wear Bar)	820, 1010, 1020 Platforms W/ 3" System (First 3 Guards on LH Drive End)	483500R3 1326787C1	G81-0183	
FS65-2	Two Prong (With Wear Bar)	820, 1010, & 1020 Platforms	613838R1	G81-0035	
BU270	(With Cross Bar)	W/3" System (All Except First 3 Guards on LH Side)	613838R2		
BU215	Double Prong with Cross Bar	M/C 8320, 8330, 8340, 8350, 8360, 8370, 8380, SC412, SC414, SC416. Windrowers 525, 625, 8210, 8220, 8230, 8240, 8820, 8830, 8840, DHX182, DHX212, DHX252, DXH362, HDX121, HDX122, HDX141, HDX142, HDX161, HDX162, HDX182, SCX100, SMX91. 2010, 2020 Headers prior to s/nCBJ020000.	86615982 700707147	G81-0155 G81-0098*	
HA200A, FS97-BH	Double Prong	Same As G81-0155. Boron	700707147	G81-0231	
		1042, 4052, 2042, 2052, 2062, 2142, 2152 and 2162	87560324, 87421451	G81-0097*	
BU299	Two Prong (With Wear Bar) (No Cross Bar)	1010, 1020, 2010, 2020 Single & Double Drive Heads s/n CBJ020001 and up	1307299C2 87442324 334305A1	G81-0037	
FS 86-2, HA250	Two Prong (Stub Grd.)	Mower/Cond. & Windrowers	049312	G81-0120	
FT 87-2, HA251	Grd. Clip (Lo-Arch)	ALL	Optional	C45-0502	
FT 88-2, HA252	Grd. Clip (Hi-Arch)	ALL	Optional	C45-0503	
FT 77-2, HA260	Two Prong	Windrowers, Tie Guard	823025C1	G81-0085	
FT 78-2, HA261	Grd. Clip (Lo-Arch)	ALL--EXCEPT 75	823026C1	C45-0500	
FT 79-2, HA262	Grd. Clip (Hi-Arch)	ALL--EXCEPT 75	823027C1	C45-0501	
FC 69-2, HA265	Two Prong	Combines w/Rigid Bars 810	633098R1	G81-0055	
FC 89-2, HA231	Two Prong	Combines w/FLOATING BARS	179775C1	G81-0125	
FS 66-DH, HA245H	Two Prong-Dbl. Heat Treat	M/C 8320, 8330, 8340, 8350, 8360, 8370, 8380. Windrowers 8210, 8220, 8230, 8240, 8820, 8830. Auger Header 8840.	1989552C1, 700700845	G81-0042	
HA270	Double Prong	Mowers 100, 110, 115 & 115. M/C 1190, 1290, 1490 & 1590. Windrowers 75, 210, 230, 275, 375, 4000, 5000 & 5500	613838R2	G81-0035	
823026C1	FT 78-2, BT261	Grd. Clip (Lo-Arch)		C45-0500	
823027C1	FT 79-2, BT262	Grd. Clip (Hi-Arch)		C45-0501	

*Double Heat Treat



MALLEABLE GUARDS

Replaces Number	Description	Application	Order No	Price
DM700	Center Guard	7/16" Bars	G81-0803	
DM700-R	Outer Guard	7/16" Bars	G81-0805	
1-1/4" CS	Rivet, 1/2 lb. /BB	7/16" Bars	R36-0468D	
MC2041Z	Center Guard	All IH Mowers	G81-0830	



WEAR PLATES



P44-0200

Replaces Number	Description	Application	Order No	Price
W 50	5-7/8", Slotted Holes w/3" Spacing	Mowers, Swathers, Combines	P44-0591	
FLW 70	7", Full Length	Mowers	P44-0412	
FLW 90	9", Full Length	Mowers	P44-0413	
MC 468	6", Wear Plate	Mowers	P44-0417	
FLW24HT	24", w/1-1/2" Spacing, Heat Treated	Tiger Jaws	P44-0200	

GUARD BOLTS

For mowers and conditioners with 7" or smaller cutter bars.

Size No. in Pkg.	Description	Order No	Price
7/16"x 1-3/8" (12)	Set Universal No. 3	B55-0700	
7/16"x 1-11/16" (18)	Head Guard Bolts		
7/16" (5)	Conical Guard Bolt Nut	N83-0593D	



BALE COUNTER

Reads up to 99,999, 4-hole mounting plate, push button reset, adjustable side arm. Fits most balers.



Order No	Price
T55-0002	

GRASS BOARD

Fits Most Mowers

Order No	Price
B52-0615	



PLASTIC BEARINGS & HARDWARE FOR PIPE REEL KITS

Description	Order No	Price
Outside Tine Bracket. Use with T16-0730 to replace LH or RH original steel reel end fingers. Fits Herschel-Adams Reel Conversion Kits. Sold individually.	B65-0120	
Outside Plastic Reel Tine for LH or RH applications on Herschel-Adams Reel Conversion Kits. Sold 12/Bag.	T16-0370	
Plastic Bearing Kit. Includes cap, base, U-Bolt & nuts. Fits Case-IH 810, 820. Sold 6/Box	B15-0915	
Plastic Bearing Kit. Includes bearing halves, bolts & nuts. Fits Case-IH 1010, 1020.	B15-0920	
AGCO Gleaner series 3 & 300, MF 9700, 9750 all with teardrop bats with rear mounted tines. Sold 6/Box.		
Plastic Bearing Kit. Includes bearing halves, bolts & nuts. Fits Case-IH 1010, 1020.	B15-0925	
Fits AGCO, Case-OH, JD, MF, NW with pipe reels. Sold 6/Box.		
Plastic Bearing Kit. Includes bearing halves, bolts & nuts. Fits Case-IH 820, 1020 w/Love Reel. Sold 6/Box.	B15-0930	



REEL TINES

Replaces Number	Description	Application	Pkg. Qty.	Order No	Price
H 1611	1 Steel	Combines Pickup Reels	100	T16-0124	
N66A	1 Mounts To Front of Bat	Nylon Flex Tine 810 Flex & 820, 1020 1987 & Older	100	T16-0183	
N67A	1 Mounts To Rear of Bat	Nylon Flex Tine 1970586C1, 1020 1988 & After	100	T16-0767	
HE1017004	2 (Plastic Flex Tooth)	Combine Pickup Tooth	500	T16-0050	
782551, 1989438C1, AH136689, AH153175	2 pc. M/L Reel Tine w/clamps	1020 w/pipe reels built up to 2000	100	T16-0720	
782226, 1989438C1, AH136689, AH153175	2 pc. M/L Reel Tine w/clamps	1020 w/pipe reels built up to 2000	10/Bag	T16-0715	
HA100MLT	M/L Reel Tine Only, Less Clamps;	For T16-0720 & T16-0715	100/Bx	T16-0725	
HA20SC	Replacement Screw	For T16-0720, T16-0715	20/BB	B55-0096D	



HERSCHEL 6" 2-PIECE POLY TINES FOR PIPE REELS

Fits: 1020 Built After 2001 & 2020 Series

- PATENTED 2 PIECE DESIGN.
- SAVE MONEY! REPLACE ONLY THE TINE.



Description	Application	Pkg. Qty.	Order No.	Price
Tine & Clamp	1020 Built After 2001 & 2020 Series	100/Box	T16-0740	
Tine & Clamp	1020 Built After 2001 & 2020 Series	10/Box	T16-0745	
Tine ONLY	1020 Built After 2001 & 2020 Series	100/Box	T16-0750	

MOWER CONDITIONER AND WINDROWER SPRING TEETH

Replaces Number	Description	Application	Pkg. Qty.	Order No	Price
540565R1	2	Reel 990, 1190	100	T16-0128	



J1 CASE/CASE IH SPRING TOOTH

Replaces Number	Description	Application	Order No	Price
R740S	2-Prong	Rakes 170, F170, 2000	T16-0305	



3/8" MOLDED POLY SKID SHOE KITS

Fits CIH 1020. Color: Silver



Sickle

Size	Order No	Price
15'	P44-1128	
20'	P44-1130	
25'	P44-1132	
30'	P44-1133	

Molded For Wearability Thick and Thin
The thickness is where it is needed most, in heavy abrasion areas. The poly shoe is thinned for areas where greater flexibility is needed. It creates a perfect tight fit to the factory metal, eliminating catch spots for debris and dirt to build-up.



RAKE AND BALER SPRING TEETH



Replaces Number	No Of Prongs	Application	Pkg. Qty.	Order No	Price
462978R1, 457374R1	1	Rakes No. 3, 4, 5, 8, 9, 11, 14, 15, 16, 30, 35, 86, 96, 97	100	T16-0126	
L2117 RH	2	Farmhand Rakes	50	T16-0368	
700706128	2	4460, 4650 4900 Hesston & Case-IH Balers	25	T16-0163	

POLY SKID SHOE KITS

- 1/4" ultra high molecular weight Polyethylene (UHMW) material is super slick and lightweight.
- The abrasion resistance of this plastic is 1.8 times greater than steel.
- Has nearly the exact same "sliding" properties as Teflon.
- Prevents losing valuable harvest days due to wet weather.
- Allows you to harvest in wet conditions or clay with no sticky build-up.
- Easy to install, just drill holes in steel plates and fasten with Hammer rivets furnished in all Kits.
- Precut and formed. All Plates come with countersunk drilled holes.
- Protects your metal skid shoes so they never wear out.
- Furnished with end plate, wobblebox plate.

Head Size	Application	Color	Order No	Price
15', 16'	Late IH - 810 Flex HC Gen III	White	P44-1090	
18'	Late IH - 810 Flex HC Gen III	White	P44-1091	
20'	Late IH - 810 Flex HC Gen III	White	P44-1092	
15'	CNH 973 & CIH 2020	Black	P44-2015	
18'	CNH 973 & CIH 2020	Black	P44-2018	
20'	CNH 973 & CIH 2020	Black	P44-2020	
22'	CNH 973 & CIH 2020	Black	P44-2022	
24'	CNH 973 & CIH 2020	Black	P44-2024	
25'	CNH 973 & CIH 2020	Black	P44-2025	
16.5'	IH 820 25 Degree	Silver	P44-1543	
20'	IH 820 25 Degree	Silver	P44-1548	
15'	IH 820 60 Degree	Silver	P44-1086	
16.5'	IH 820 60 Degree	Silver	P44-1087	

AUGER FINGERS

Durable and Flexible. Replace the original metal fingers in combine augers.

Poly fingers are strong and resilient and will bend 10° past the breaking point of metal fingers. Broken metal fingers can do costly damage to rotors and cylinders by gouging or poking through the auger. A loose metal finger can cut an auger in half in 15 seconds.



Poly fingers will disintegrate as they go through the combine. They are literally ground to a dust that will not damage internal working parts of the combine like rotors and cylinders.

Must use universal plastic guide for fingers to work. Poly fingers will not work with OEM metal guides.

Application	Pack Qty	Order No.	Price
IH Auger Finger Only. For 1020	24 PK	P44-0105	
IH Auger Finger Kit. For 1020	1 Kit	P44-0107	
Universal Guide. For 1020, 2020	Each	P44-0115	
Auger Finger. For 2020	24 PK	P44-0120	
Auger Finger. For 2020	100 PK	P44-0119	
Auger Finger Kit For 2020	12 PK	P44-0121	

HAMMER RIVETS AND TOOL

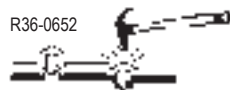

T55-0812



Size	Description	Application	Pkg Qty.	Order No	Price
3/16" x 5/16"	Small Head	IH 1020 (1994 & Before)	50/BB	R36-0652	
3/16" x 5/16"	Large Head	IH 820, HC III	50/BB	R36-0655	
		Hammer Rivet Tool for Drive Rivets		T55-0812	

POLY REPLACEMENT PARTS FOR HERSCHEL SPECKLED POLY KITS

Replaces Number	Size Length x Width	Rivets Required	Qty. Required											Order No	Price	
			13'	15'	16'	17.5'	18'	20'	22.5'	24'	25'	30'				
CASE-IH - 820 Header - 25°																
IHC820-6	15" x 6"	4	4	4	4	4			6	6					P44-1102	
IHC820-12	15" x 12"	6	1	1	1	1			1	1					P44-1103	
IHC820-42	18" x 42"	24		2					2	4					P44-1106	
IHC820-56	18" x 56"	30			2	2									P44-1107	
	18" x 21"	12							2						P44-1158	
	18" x 32"	18	4	2	2	2			2	2					P44-1159	
	18" x 42"	24		2					2	4					P44-1160	
CASE-IH - 1020 Headers (1994 and before)																
IH1020-6	6" Cover Plate	4		27		34			37	44		47	57		P44-1581	
IH1020-9LH	9" Cover Plate LH	6		1					1			1	1		P44-1582	
IH1020-9RH	9" Cover Plate RH	6		1					1			1	1		P44-1591	
IH1020-HCPF	Head Cover-Front	4		1		1			1	1		1	1		P44-1583	
IH1020-HCPR	Head Cover-Rear	4		1		1			1	1		1	1		P44-1584	
IH1020-TCP	Tail Cover Plate	2		1		1			1	1		1	1		P44-1585	
SPK-IH1020SP	Stabilizer Plate	11		1		1			1	1		1	1		P44-1125	
HART CARTER - Generation III																
HC3-18	7" x 18"	8	3	4	4		5	6			8				P44-1121	
HC3-33	7" x 33"	12	1	1	1		1	1			1				P44-1122	
HC3-44	7" x 44"	16	1	1	1		1	1			1				P44-1123	

GATHERING CHAINS

Replaces OEM No. 176279C91

Fits 800, 900 & 1000 Series



Chain	Att.Lk.	Offset	Conn.	Total		
Type & Qty	Type & Qty.	Links	Links	Links	Order No	Price
CA555 (40)	C6E(8)	None	Endless	48	C30-0120	
CA555 (40)	C6E(8)	None	Endless	48	C30-0121*	

*Import

GATHERING CHAIN DRIVE SPROCKETS



Replaces

OEM No	Application	Order No.	Price
199497C1	800, 900, 1000 w/Key & Roll Pin Hole	S62-0725	

GATHERING CHAIN IDLER SPROCKET



Replaces

OEM No	Application	Order No	Price
176283C91	80, 900, 1000 Series	S62-0741	



BOLT ON SPEARS

Nut Included. Order Sleeve Separately.

Description	Length	Capacity	Order No	Price
Threaded Standard Duty	32"	2500 lbs	BS32WN	
Threaded Standard Duty	43"	2500 lbs	BS43WN	
Threaded Standard Duty	49"	2500 lbs	BS49WN	
Threaded Heavy Duty	32"	3500 lbs	BS32WNHD	
Threaded Heavy Duty	43"	3500 lbs	BS43WNHD	
Threaded Heavy Duty	49"	3500 lbs	BS49WNHD	

PIN ON SPEARS

Order Bushing/Sleeve Separately.

Description	Length	Capacity	Order No	Price
Cross Bolt Standard Duty	43"	2500 lbs	BS43CB	
Cross Bolt Standard Duty	49"	2500 lbs	BS49CB	

HARDWARE

Description	Order No	Price
Nut. 1.18" diameter	BSNUT	
Sleeve Standard Duty. 4.72" long	BSSLEEVE	
Sleeve Heavy Duty. 5.71" long	BSSLEEVEHD	
Sleeve For Pin On w/1/2" hole. 5.71" long	BSSLEEVECB	

Assembling Advice For Square Tines



RIGHT

WRONG

- High Tensile Strength Heat Treated Steel
- Standard Duty 2500# 1-3/4" Diameter
- Heavy Duty 3500# 1-3/4" Diameter
- Threaded Spears Include Nut

B
 Baler Teeth29
 Bolts, Section26

C
 Clips, Hold Down29

D
 Disc Mower Knives29

E
 End Sections26

G
 Guards.....29

H
 Head Socket Assemblies.....29
 Hold Down Clips29

O
 Overlap Sections26

R
 Rivets, Section.....26

S
 Sections.....26
 Section Bolts.....26
 Section Rivets.....26
 Sickle Assemblies.....27 - 28
 Sickle Heads.....29

T
 Teeth, Baler29

W
 Windrower Teeth29

SECTION TYPE ABBREVIATIONS

Section Finish	Section Type	Section Thickness
CR = Chrome	7TS = Super 7 Top Serrated SM = Smooth US = Under Serrated TS = Top Serrated TT = Tiger Tooth TJ = Tiger Jaw SRK = Tiger Shark	XH = Extra Heavy .116"

SECTIONS

Replaces Number	Size	Description	Application	Section Design	Rivet Used	Pkg Qty	Order No	Price
049213	3" x 3-1/4"	XHTSCR	All Windrowers	B	1/2 OH	10	S20-4013	
048009	3" x 3-1/4"	XHUSCR		B-	1/2 OH	10	S20-6332	
049262	3" x 3-1/4"	XHSMCR		B	9/16 OH	10	S20-2758	
048868	1/2 Section	XHSMCR			1/2 OH	10	S20-2521	
049254		XHTSCR				10	S20-4564	
	3" x 3-1/4"	Tiger Shark™	Used To Replace OEM Numbers Listed Below		5/8 OH	10	S20-8268	
700705300	3" x 3-1/4"	XHTSCR	Windrowers &		5/8 OH	10	S20-4277	
700705300	3" x 3-1/4"	XH7TSCR	Mower Conditioners		5/8 OH	10	S20-4268	
700705299	3" x 3-1/4"	XH7TS			5/8 OH	10	S20-3325	



TIGER TOOTH SECTIONS

Fits Mower Conditioners & Windrowers



Replaces Number	Size	Description	Section Design	Bolt Used	Pkg Qty	Order No	Price
TT049254	3" x 3-1/4"	XHTTCR	R	B55-0065D	10	S20-4464	
SSTJ7000	3" x 3-1/4"	XH7TTCR	R+	B55-0065D	10	S20-4317	

UNIVERSAL END SECTIONS

For All Mowers, Mower Conditioners With Standard Cutterbars
HERSCHEL "End Sections" are made of one-piece high carbon, heat treated steel for rugged use. They are punched with an oblong hole to virtually fit any standard cutterbar mower in use today. To install our "End Section", simply take off the last section on the shoe end of your sickle assembly and replace it with an "End Section". The change-over takes only a couple of minutes to complete and you will notice a big difference in time saved from unclogging your mower. We recommend using a R36-0523D oval head rivet or B55-0065D Bolt and nut.

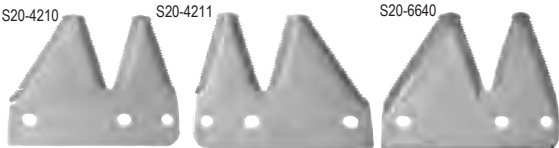

Description	Order No	Price
XH7TSCR (RH) 10/Box	S20-4403	
XH7TSCR (RH) 2/SP	S20-4403D	
XH7TSCR (LH) 10/Box	S20-4445	
XH7TSCR (LH) 2/SP	S20-4445D	
XHTS CR (RH) 10/Box	S20-4210	
XHTS CR (RH) 2/SP	S20-4210D	
XHTSCR (LH) 10/Box	S20-4211	
XHTSCR (LH) 2/SP	S20-4211D	
XHUSCR (RH) 10/Box	S20-6640	

OVERLAP SECTIONS - 3" X 3-1/4"

10 Per Package



Replaces Number	Description	Application	Section Design	Rivet Used	Order No	Price
748152	XH TS CR	Bottom CTSK Overlap		5/8 CS	S20-4382	
748210	XH TS CR	6665 Header		5/8 CS		
SSTS635161	XH 7TS CR	1170 & 8400 Windrowers	B+	Btm CTSK	S20-4309	
TS635161	XH TS CR	M/C Overlap 3RH & 2LH Used			S20-4371	

OVERLAP SECTION KITS

Application	Kit Contains	Order No	Price
6666 & 6665 Headers	(2) S20-4382-(748152.); (3) S20-4382-(748210.); (10) B55-0059-CTSK Bolt & Nut	S20-4000	
1170 & 8400	(5) S20-4371-XH TS CR; (3) RH & 2 LH) Btm. CTSK (10) B55-0059-CTSK Bolts & Nuts	S20-4003	
Overlap Kit	(5) Sections, (1) Wear Bar, (11) Bolts	S20-4007	



SECTION BOLTS

Description	Application	Qty. Pkg.	Mstr Ctn	Order No	Price
Section Bolt w/Nut	Universal - Replaces 9/16" & 5/8" OH Rivet	50	300	B55-0065D	
Head Bolt w/Nut	Universal - Replaces 1" & 1-1/16" OH Rivets	15	90	B55-0085D	
Head Bolt w/Nut	Universal - Replaces 1" OH Rivets	12	72	B55-0095D	
Section Bolt w/Nut	Universal - Bolts for 10' Sickle w/head bolts (80 - TJ55BN, 5 - TJ85BN, 5-TJ95BN)	90	Each	B55-0500D	
Overlap Bolt w/low profile nut	Double Drive Sickles (use with Allen Wrench)	10	60	B55-0059D	
Nut	Universal Fits All Above Bolts	20	120	N83-0289D	
Low Profile Nut	Overlap Sickles, Use w/B55-0059D	20	120	N83-0295D	



ZINC PLATED RIVETS

Size/No. in Pkg	Description	Application	Pkg Qty.	Mstr Ctn	Order No	Price
5/8" # 5-1/2 (56); 1" # 5-1/2 (10)	OH Rivets Asst.	7' Heavy Mower Sections and Knife Heads	Asst.	6	R36-0523D	
5/8" # 5-1/2 (72); 1" # 5-1/2 (5); 1-1/4" # 5-1/2 (5)	OH Rivets Asst.	Mower Conditioners	Asst.	6	R36-0524D	
1/2" OH	OH Rivets	Regular Gauge Sections	1#	6#	R36-0521D	
9/16" OH	OH Rivets	Heavy Gauge Sections	1#	6#	R36-0461D	
5/8" OH	OH Rivets	Heavy Gauge Sections	1#	6#	R36-0462D	
15/16" OH	OH Rivets	Head	1/2#	3#	R36-0522D	
1" OH	OH Rivets	Head	1/2#	3#	R36-0465D	
1-1/4" OH	OH Rivets	Head	1/2#	3#	R36-0467D	
1/2" CS	CS Rivets	Section	1#	6#	R36-0464D	
5/8" CS	CS Rivets	Section	1#	6#	R36-0463D	
1" CS	CS Rivets	Section	1/2#	3#	R36-0466D	
1-1/4" CS	CS Rivets	Guard Plate	1/2#	3#	R36-0468D	

MOWER CONDITIONERS PT-7, PT-10, 1010

OEM #	Length	No. Of Sections	Head	Head OEM #	Type	Section	Section OEM #	Riveted Order No	Riveted Price	Bolted Order No	Price
6193510 HD	7'	30	H15-0880	451948 HD	XHTSCR	S20-4013	049213	S35-4593	-	-	-

MOWER CONDITIONERS PT-7, PT-10, 1011

OEM #	Length	No. Of Sections	Head	Head OEM #	Type	Section	Section OEM #	Riveted Order No	Riveted Price	Bolted Order No	Price
6566178 HD	9'	38	-	-	XHTSCR	S20-4564	049254	-	-	S35-2359	-

MOWER CONDITIONERS PT-7, PT-10, 1012

OEM #	Length	No. Of Sections	Head	Head OEM #	Type	Section	Section OEM #	Riveted Order No	Riveted Price	Bolted Order No	Price
491955 HD	9'	38	-	-	XHTSCR	S20-4013	049213	S35-4594	-	-	-

MOWER CONDITIONERS PT-12

OEM #	Length	No. Of Sections	Head	Head OEM #	Type	Section	Section OEM #	Riveted Order No	Riveted Price	Bolted Order No	Price
429498	12'	49	-	433102	XHTSCR	S20-4013	049213	S35-4325	-	-	-

MOWER CONDITIONERS 1070, 1071, 1085, 1090, 1091, 1095

OEM #	Length	No. Of Sections	Head	Head OEM #	Type	Section	Section OEM #	Riveted Order No	Riveted Price	Bolted Order No	Price
6584031, 70071198	7'	28	-	-	XHTSCR	S20-4564	049254	S35-4317	-	-	-

MOWER CONDITIONERS 1070, 1071, 1085, 1090, 1091, 1096

OEM #	Length	No. Of Sections	Head	Head OEM #	Type	Section	Section OEM #	Riveted Order No	Riveted Price	Bolted Order No	Price
6582522, 700711979	9'	37	-	-	XHTSCR	S20-4564	049254	S35-4318	-	-	-

MOWER CONDITIONERS 1070, 1071, 1085, 1090, 1091, 1097

OEM #	Length	No. Of Sections	Head	Head OEM #	Type	Section	Section OEM #	Riveted Order No	Riveted Price	Bolted Order No	Price
SS6582522	9'	37	-	-	XH7TSCR	S20-4268	SS700705300	-	-	S35-2728	-

WINDROWERS 200, 220, 240, 260, 280, 300, 500

OEM #	Length	No. Of Sections	Head	Head OEM #	Type	Section	Section OEM #	Riveted Order No	Riveted Price	Bolted Order No	Price
373530 S	14'	57	-	-	XHTSCR	S20-4013	049213	-	-	S35-2291	-
373530 HS	14'	57	-	-	XHTSCR	S20-4564	049254	S35-4452	-	-	-

WINDROWERS 520, 620, 1014 HYDRO-SWING, 6200, 6400, 6465, 6550, 6600, 6610 11 HOLE HEAD

OEM #	Length	No. Of Sections	Head	Head OEM #	Type	Section	Section OEM #	Riveted Order No	Riveted Price	Bolted Order No	Price
6272959	12'	49	-	6193577	XHTSCR	S20-4564	049254	S35-4881	-	-	-
SSTT6497101	12'	50	-	TT6497416	XH7TSCR	S20-4317	SSTJ7000	-	-	S35-2375	-
6272967	14'	57	-	6193577	XHTSCR	S20-4564	049254	S35-4879	-	-	-

WINDROWERS 520, 620, 1014 HYDRO-SWING, 6200, 6400, 6450, 6550, 6600, 6610 21 HOLE HEAD

OEM #	Length	No. Of Sections	Head	Head OEM #	Type	Section	Section OEM #	Riveted Order No	Riveted Price	Bolted Order No	Price
6497101	12'	49	-	-	XHTSCR	S20-4564	049254	-	-	S35-2101	-
SSTT6497101	12'	50	-	-	XH7TSCR	S20-4317	SSTJ7000	-	-	S35-2375	-
SS6497119	14'	57	-	-	XH7TSCR	S20-4268	SS700705300	-	-	S35-2730	-
6497374 700705843	16'	65	-	-	XHTSCR	S20-4564	049254	-	-	S35-2731	-
6206031	14'	57	Headless	-	XHTSCR	S20-4013	049213	-	-	S35-2291	-
6497465	14'	57	Headless	-	XHTSCR	S20-4564	049254	S35-4452	-	S35-2452	-

WINDROWERS 1014+2 HYDRO SWING, 6450, 6455, 6550, 6555, 6566, 6650, 6655, 6660, 6665, 8100 AUGER HEADER, 21' DRAPER HEADER

OEM #	Length	No. Of Sections	Head	Head OEM #	Type	Section	Section OEM #	Riveted Order No	Riveted Price	Bolted Order No	Price
6832174	7' LH	25	H15-0390	6821078	XHTSCR	S20-4564	049254	S35-4390	-	-	-
SS6832174	7' LH	25	H15-0390	6821078	XH7TSCR	S20-4268	SS700705300	-	-	S35-2285	-
6832224	7' RH	25	H15-0301	6821136	XHTSCR	S20-4564	049254	S35-4391	-	-	-
SS6832224	7' RH	25	H15-0301	6821136	XH7TSCR	S20-4268	SS700705300	-	-	S35-2286	-
6832182	8' LH	29	H15-0390	6821078	XHTSCR	S20-4564	049254	S35-4388	-	-	-
SS6832182	8' LH	29	H15-0390	6821078	XH7TSCR	S20-4268	SS700705300	-	-	S35-2325	-
6832232	8' RH	29	H15-0301	6821136	XHTSCR	S20-4564	049254	S35-4389	-	-	-
SS6832232	8' RH	29	H15-0301	6821136	XH7TSCR	S20-4268	SS700705300	-	-	S35-2326	-
SS700705854	9' LH	33	H15-0390	6821078	XH7TSCR	S20-4268	SS700705300	-	-	S35-2272	-
SS700705861	9' RH	33	H15-0301	6821136	XH7TSCR	S20-4268	SS700705300	-	-	S35-2273	-
SS700705856	10.5' LH	39	H15-0390	6821078	XH7TSCR	S20-4268	SS700705300	-	-	S35-2274	-
SS700705862	10.5' RH	39	H15-0301	6821136	XH7TSCR	S20-4268	SS700705300	-	-	S35-2275	-

MOWER CONDITIONERS 1170, 1270, 1275; WINDROWERS 8020, 8400, 8450, 8600 WITH 625 AUGER HEADERS

OEM #	Length	No. Of Sections	Head	Head OEM #	Type	Section	Section OEM #	Riveted Order No	Riveted Price	Bolted Order No	Price
SS700114590	7' LH	28	H15-0063	700114594	XH7TSCR	S20-4268	SS700705300	-		S35-2001	
SS700709581	7' LH	28	Headless	-	XH7TSCR	S20-4268	SS700705300	-		S35-2003	
SS700114591	7' RH	28	H15-0063	700114594	XH7TSCR	S20-4268	SS700705300	-		S35-2002	
SS700709582	7' RH	28	Headless	-	XH7TSCR	S20-4268	SS700705300	-		S35-2004	
700114590	7' LH	28	H15-0063	700114594	Tiger Shark™	S20-8268				S35-2517	
700114591	7' RH	28	H15-0063	700114594	Tiger Shark™	S20-8268				S35-2519	
700715165	7' LH	28	H15-0063	700114594	XHTSCR	S20-4277	700705300	-		S35-2067	
700709581	7' LH	28	Headless	-	XHTSCR	S20-4277	700705300	-		S35-2113	
700715166	7' RH	28	H15-0063	700114594	XHTSCR	S20-4277	700705300	-		S35-2068	
700709582	7' RH	28	Headless	-	XHTSCR	S20-4277	700705300	-		S35-2114	
SS700114592	8' LH	32	H15-0063	700114594	XH7TSCR	S20-4268	SS700705300	-		S35-2014	
					Tiger Shark™	S20-8268				S35-2528	
SS700709585	8' LH	32	Headless	-	XH7TSCR	S20-4268	SS700705300	-		S35-2017	
SS700114593	8' RH	32	H15-0063	700114594	XH7TSCR	S20-4268	SS700705300	-		S35-2015	
					Tiger Shark™	S20-8268				S35-2532	
SS700709586	8' RH	32	Headless	-	XH7TSCR	S20-4268	SS700705300	-		S35-2016	
700715167	8' LH	32	H15-0063	700114594	XHTSCR	S20-4277	700705300	-		S35-2069	
700114894	8' LH	32	Headless	-	XHTSCR	S20-4277	700705300	-		S35-2111	
700715168	8' RH	32	H15-0063	700114594	XHTSCR	S20-4277	700705300	-		S35-2070	
700715168	8' RH	32	Headless	-	XHTSCR	S20-4277	700705300	-		S35-2112	
SS700715778	9' LH	36	H15-0063	700114594	XH7TSCR	S20-4268	SS700705300	-		S35-2305	
SS700715778	9' LH	36	Headless	-	XH7TSCR	S20-4268	SS700705300	-		S35-2306	
SS700715779	9' RH	37	H15-0063	700114594	XH7TSCR	S20-4268	SS700705300	-		S35-2309	
SS700715779	9' RH	37	Headless	-	XH7TSCR	S20-4268	SS700705300	-		S35-2310	
700715778	9' LH	36	H15-0063	700114594	XHTSCR	S20-4277	700705300	-		S35-2307	
700715778	9' LH	36	Headless	-	XHTSCR	S20-4277	700705300	-		S35-2308	
700715779	9' RH	37	H15-0063	700114594	XHTSCR	S20-4277	700705300	-		S35-2311	
700715779	9' RH	37	Headless	-	XHTSCR	S20-4277	700705300	-		S35-2312	

MOWER CONDITIONER 1130

OEM #	Length	No. Of Sections	Head	Head OEM #	Type	Section	Section OEM #	Riveted Order No	Riveted Price	Bolted Order No	Price
700118673	9'	37	H15-0066	700111003	XHTSCR	S20-4277	700705300	-		S35-2071	

MOWER CONDITIONER 1110

OEM #	Length	No. Of Sections	Head	Head OEM #	Type	Section	Section OEM #	Riveted Order No	Riveted Price	Bolted Order No	Price
700000573	7'	27	H15-0390	6821078	XHTSCR	S20-4564	049254	-		S35-2080	
700111432											

MOWER CONDITIONER 1120

OEM #	Length	No. Of Sections	Head	Head OEM #	Type	Section	Section OEM #	Riveted Order No	Riveted Price	Bolted Order No	Price
SS700111430	9'	35	H15-0390	6821078	XH7TSCR	S20-4268	SS700705300	-		S35-2081	

CONDITIONER 1150

OEM #	Length	No. Of Sections	Head	Head OEM #	Type	Section	Section OEM #	Riveted Order No	Riveted Price	Bolted Order No	Price
S700109341	12'	46	H15-0390	6821078	XH7TSCR	S20-4268	SS700705300	-		S35-2082	

WINDROWERS 1160, 1260, 1265, 8200 CENTER PIVOT WITH 425 HEADER

OEM #	Length	No. Of Sections	Head	Head OEM #	Type	Section	Section OEM #	Riveted Order No	Riveted Price	Bolted Order No	Price
700709622	12'	48	H15-0066	700111003	XHTSCR	S20-4277	700705300	-		S35-2072	
700709623	14'	56	H15-0066	700111003	XHTSCR	S20-4277	700705300	-		S35-2073	

HESSTON SICKLE HEADS, DISC MOWER KNIVES, GUARDS AND TEETH 2016

SICKLE HEADS

Replaces Number	Description	Application	Order No	Price
6821078	Sickle Head LH	6650 & 6665 Auger Header, 6450, 6550, 6650 Windrowers 1110, 1120, 1150, Mower Cond.	H15-0390	
6821136	Sickle Head RH	6650 & 6665 Auger Header, 6550, 6650 Windrowers 1110, 1120, 1150, Mower Cond.	H15-0301	
700111003	Head	Single Drive 1130, 1160, 8200	H15-0066	
700114594	Head LH & RH	Double Drive 1170, 8400, 8450, 8020, 8600. Double needle bearing.	H15-0063	

DISC MOWER KNIVES

OEM Number	Application	Length Inches	Dia. Inches	Style	Shape	Bolt Order No	6 Blades Order No	Price	25 Blades Order No	Price
HESSTON										
700713983	1320, 1340, 1345, 1355, 1360, 1365, 1375,	4.21	.717"	4	RH Twisted	B55-0344D	B45-6568D		B45-6568	
700713984	3312, 3315, 8070, 8500, 9070, 9075, 9080, 9190, 9192	4.21	.717"	4	LH Twisted	B55-0344D	B45-6569D		B45-6569	
527746	1004, 1005, 1006, 1007, 1008, 3006,	4.76	.890"	5	RH Twisted	B55-0355D	B45-6563D		B45-6563	
527747	3007, 3008, 3009, 3010, 3309	4.76	.890"	5	LH Twisted	B55-0355D	B45-6564D		B45-6564	
DM303	1030, 1035, 1040, 1050, 1060	3.66	.640"	4	LH Twisted	B55-0358D	B45-6996D		B45-6996	
DM304		3.66	.640"	4	RH Twisted	B55-0358D	B45-6997D		B45-6997	
700715576	8500	4.21	.728"	5	RH Twisted	B55-0342D	B45-6559D		B45-6559	
700715575		4.21	.728"	5	LH Twisted	B55-0342D	B45-6560D		B45-6560	
86625673	18° Bottom Bevel. 8070, 1320, 1340, 1360, 1365	4.21	.728"		LH Twisted	B55-0342D	B45-6572D		B45-6572	
86625674	18° Bottom Bevel. 8070, 1320, 1340, 1360, 1365	4.21	.728"		RH Twisted	B55-0342D	B45-6573D		B45-6573	
86625673	18° Top Bevel. 8070, 1320, 1340, 1360, 1365	4.21	.728"	5	LH Twisted	B55-0342D	B45-6725D		B45-6725	
86625674	18° Top Bevel. 8070, 1320, 1340, 1360, 1365	4.21	.728"	5	RH Twisted	B55-0342D	B45-6726D		B45-6726	

HOLD DOWN CLIPS

Style	Description	Application	Order No	Price
Non-Adjustable				
Steel	Clip (Lo-Arch)	All Mower / Cond. & Windrowers	C45-0692	
Steel	Clip (Hi-Arch)	All Mower / Cond. & Windrowers	C45-0693	
Adjustable				
Cast	Lo-Arch Clip	All Mower Conditioners & Swathers.	C45-0006	
Cast	Hi-Arch Clip	All Mower Conditioners & Swathers.	C45-0007	
Cast	Clip Arch Only, Low	For C45-0006	C45-0008	
	Rubber Elastomer	Use with C45-0006 & C45-0007	R36-0001	
Cast	Lo-Arch	All Windrowers & Mower Cond.	C45-0040	

UNIVERSAL SICKLES WITH SUPER 7® SECTIONS FOR ALL SINGLE DRIVE M/C & WINDROWERS

Description	Head Number	Bolted Order No	Price
7' XH7TS Knife	Headless	S35-1038	
9' XH7TS Knife	Headless	S35-1039	
2' XH7TS Knife Ext. w/Splice Kit & Bolts	Headless	S35-1040	
5' XH7TS Knife Ext.	Headless	S35-1041	

GUARDS



OEM Number	Replaces Number	Description	Application	Order No	Price
049312	FS 86-2, BU250	Two Prong (Stub Grd.)	M/C & Windrowers	G81-0120	
6284897	FT 87-2, BT251	Grd. Clip (Lo-Arch)	All with Stub Guard	C45-0502	
6284889	FT 88-2, BT252	Grd. Clip (Hi-Arch)		C45-0503	
049270	FT 77-2, HA260	Two Prong Tie Guard	All Windrowers	G81-0085	
6180500, 6213789	FT 78-2, BU261	Grd. Clip (Lo-Arch)	All w/Tie Guard	C45-0500	
6108518	FT 79-2, BU262	Grd. Clip (Hi-Arch)		C45-0501	
700700845	FS 66-DH, BU245H	Two Prong Dbl. Heat Treated	"Super Guard", All Hesston M/C & Windrowers	G81-0042	

2- PRONG BALER / WINDROWER TEETH

Replaces Number	Description	Application	Pkg. Qty.	Order No	Price
7894751	Spring	Windrowers, Pickup & Forage Harvester	100	T16-0012	
750075	Spring	Windrowers PT-10 420, 620, 6600 & 1014	100	T16-0030	
7751621	Baler	Baler, Large Round, 5600 & 5800	100	T16-0040	
700706128	Baler	4900 Hesston & Case-IH Balers	100	T16-0163	
7893746	Baler	1 ton Freeman, 48W Hesston Baler	100	T16-0164	

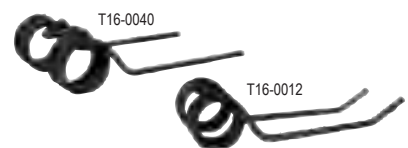

A	
Auger Fingers	38
B	
Bale Counter	37
Baler Bearings	40
Baler Sprockets, Round	40
Baler Teeth	38
Bearings, Plastic Reel	38
Bolts, Guard	37
Bolts, Section	32
D	
Disc Mower Knives	36
C	
Chains, Gathering	39
Clips, Hold Down	37
Combine Cutterbar Replacement Kits	36
Combine Teeth	38
Corn Head Rollers	39
E	
End Sections	31
G	
Gathering Chain	39
Gathering Chain Sprockets	39
Grass Board	37
Guard Bolts	37
Guards	37
H	
Hammer Rivets	39
Hammer Rivet Tool	39
Hold Down Clips	37
K	
Kits, Combine Cutterbar Replacement	36
Kits, Overlap	30
Kits, Poly Skid Shoe	38
Kits, Spliced	35
O	
Overlap Kits	31
P	
Pick-Up Teeth	38
Pitman Woods	37
Plastic Reel Bearings	38
Plastic Tines	38
Poly Replacement Parts	38 - 39
Poly Skid Shoe Kits	38

R	
Rake Teeth	38
Reel Tines	38
Replacement Parts, Poly	39
Rivets, Hammer	39
Rivets, Section	32
Round Baler Bearings	40
Round Baler Sprockets	40
S	
Sections	31
Section Bolts	32
Section Rivets	32
Sickle Backs	36
Sickle Heads	36
Sickles	32 - 35
Skid Shoe Kits	38
Splice Kits	35
Spliced Sickles	35
Sprockets, Round Baler	40
Sprockets, Gathering Chain	39
T	
Teeth, Baler	38
Teeth, Combine	38
Teeth, Pick-up	38
Tines, Reel	38
Tooth, Rake	38
W	
Wear Plate	37

SECTION TYPE ABBREVIATIONS

All sections in packages of 10 *Sold in packages of 2

Section Thickness XH = Extra Heavy .116"	Section Finish CR = Chrome	Section Type 7TS = Super 7 Top Serrated SM = Smooth	US = Under Serrated S = Top Serrated TS = Top Serrated	TT = Tiger Tooth TJ = Tiger Jaw SRK = Tiger Shark
--	--------------------------------------	--	--	---

SECTIONS

Replaces Number	Size	Description	Application	Section Design	Rivet Used	Order No	Price
Z7029H, E76373	3" x 3-3/16"	XHUS	All Mowers, M/C & Windrowers	A-	9/16 OH	S20-5110	
E76372, Z6451H	3" x 3-3/16"	XHSM		A-	9/16 OH	S20-1142	
E76373, Z7030H	3" x 3-3/16"	XHUS		A-	9/16 OH	S20-5246	
E76371, H21530H	3" x 3-3/16"	XHUSCR		A-	9/16 OH	S20-6344	
E71947	3" x 3-3/16"	XHTSCR(Top CS)	Windrower, 300 Twin	A	5/8 CS	S20-4130	
E71948	3" x 3-3/16"	XHTSCR(BtmCS)	Drive Header	A	5/8 CS	S20-4131	
E71947	3" x 3-3/16"	XH7TSCR(TopCS)	- overlap section, 300 Twin	A+	5/8 CS	S20-4328	
E71948	3" x 3-3/16"	XH7TSCR(BtmCS)	- overlap section	A+	5/8 CS	S20-4329	
W30344, W36402	3" x 3-1/4"	XHUS	Windrower 580, 590, 2360	C-	9/16 OH	S20-5236	
W30344CR	3" x 3-1/4"	XHUSCR		C-	9/16 OH	S20-6492	
W35888	3" x 3-1/4"	XHTSCR		C	9/16 OH	S20-4969	
34390CR-CSK	3" x 3-7/32"	XHTSCR	Windrower 2360, Overlap	C+	5/8 OH	S20-4399	
W35888, 34390CR	3" x 3-1/4"	XHTSCR	Windrower 2360, XHi-Shoulder	F	5/8 OH	S20-4097	
H21527H, E130477, H213806	3" x 3-1/4"	XHTSCR	55, 65, 95, 105	N	1/4 x 5/8 OH	S20-4641	
H84415, H213805	3" x 3-1/4"	XH7TSCR	200, 900 Combines with 200 & 900 series headers	N+	5/8 OH	S20-4267	
H84415, H130478, H213815	3" x 3-1/4"	XHTSCR		N	5/8 OH	S20-4719	
H226351	4"	Tiger Shark™(TopCS)	600 Series Double Drives. Used In Overlap Area.		B55-0075D	S20-8540	
H163132	1/2	XH7TSCR	600 Rigid & Flex,		B55-0075D	S20-4537	
H163132	1/2	Tiger Shark™	900 Draper Headers		B55-0075D	S20-8537	
H161242	1/2	XHTSCR			B55-0075D	S20-4536	
H163132	1/2	XH7TSCR			B55-0075D	S20-4537D*	
H161242	1/2	XHTSCR			B55-0075D	S20-4536D*	
	3" x 4"	Tiger Shark™	Used To Replace OEM Numbers Listed Below		B55-0075D	S20-8531	
H163131	3" x 4"	XH7TSCR	600 Rigid & Flex,		B55-0075D	S20-4531	
H153329	3" x 4"	XHTSCR	900 Draper Headers		B55-0075D	S20-4532	
	3" x 3-1/4"	Tiger Shark™	Used To Replace OEM Numbers Listed Below		B55-0065D	S20-8452	
H136807, H207930	3" x 3-1/4"	XH7TSCR, 2-Hole	200 & 900 Series Headers	N+	B55-0065D	S20-4452	
H136807, H207929	3" x 3-1/4"	XHTSCR, 2-Hole		N	B55-0065D	S20-4451	
	3" x 3-3/16"	Tiger Shark™	Used To Replace OEM Numbers Listed Below		9/16 OH	S20-8286	
E45996, E76370, E90571	3" x 3-3/16"	XH7TSCR	Mowers, Conditioners & Windrowers	A+	9/16 OH	S20-4286	
E45996, E76370, E90571	3" x 3-3/16"	XHTSCR		A	9/16 OH	S20-4777	
E45996, E76370, E90571	3" x 3-3/16"	XHTS		A	9/16 OH	S20-3996	
E45996, E76370, E90571	3" x 3-3/16"	XH7TS		A+	9/16 OH	S20-3407	
E45996, E76370, E90571	3" x 3-3/16"	Tiger Shark™(TopCS)		A+	9/16 OH	S20-8328	
E45996, E76370, E90571	3" x 3-3/16"	Tiger Shark™(BtmCS)		A+	9/16 OH	S20-8329	
	3" x 3-1/4"	Tiger Shark™	Used To Replace OEM Numbers Listed Below		5/8 OH	S20-8398	
W34602CR, W35888CR	3" x 3-1/4"	XH7TSCR	140, 160, 580 & 90 Windrowers,	C+	5/8 OH	S20-4398	
W34602CR, W35888CR	3" x 3-1/4"	XHTSCR	Mower Conditioners 1212, 1214 & 1216	C	5/8 OH	S20-4170	
W34602, W35888	3" x 3-1/4"	XHTS		C	5/8 OH	S20-3283	TJ1200
1/2 Section		All Combine 3" & 1-1/2 Systems			B55-0065D	S20-0297	



JOHN DEERE

UNIVERSAL END SECTIONS

For All Mowers, Mower Conditioners w/Standard Cutterbar

HERSCHEL "End Sections" are made of heat-treated steel for rugged use. They are punched with an oblong hole to virtually fit any standard cutterbar mower in use today. To install our "End Section", simply take off the last section on the shoe end of your sickle assembly and replace it with an "End Section". The change-over takes only a couple of minutes to complete and you will notice a big difference in time saved from unlogging your mower. We recommend using a R36-0523D oval head rivet or B55-0065D Bolt.



Description	Order No.	Price	Description	Order No.	Price
XH7TSCR (RH) 10/Box	S20-4403		XHTS CR (RH) 2/SP	S20-4210D	S20-6640
XH7TSCR (RH) 2/SP	S20-4403D		XHTSCR (LH) 10/Box	S20-4211	
XH7TSCR (LH) 10/Box	S20-4445		XHTSCR (LH) 2/SP	S20-4211D	
XH7TSCR (LH) 2/SP	S20-4445D		XHUSCR (RH) 10/Box	S20-6640	
XHTS CR (RH) 10/Box	S20-4210		XHUSCR (RH) 2/SP	S20-6640D	

OVERLAP SECTION KIT FOR DOUBLE DRIVES

For Mower & Mower Conditioner 300 Twin Drive Headers

Description	Order No.	Price
(1) S20-4131 - E71948	S20-4002	
(3) S20-4130 - E71947		
(8) B55-0059 -CTSK Bolt & Nut		

OVERLAP SECTION KIT FOR DOUBLE DRIVES

For 300, 1600, 890, 4890 Mowers

Description	Order No.	Price
(6) Sections	S20-4006	
(10) CTSK Bolts & Nuts		

TIGER TOOTH / TIGER JAWS SECTIONS

Replaces Number	Size	Description	Application	Section Design	Rivet Used	Order No	Price
ITE45996	3" x 3"	XH TT CR	Mower & Mower/Cond.	S	B55-0065D	S20-4697	
SSTTE45996	3" x 3-1/8"	XH7TTCR		S+	B55-0065D	S20-4414	
SSTTE71947	3" x 3-1/8"	XH7TTCR(Top CS)	Windrower Overlap Section	S+	5/8 CS	S20-4415	
SSTTE71948	3" x 3-1/8"	XH7TTCR(Btm CS)		S+	5/8 CS	S20-4416	
TJ7000	3" x 3-1/4"	XH TJ CR	Combine w/Tiger Jaws	R	B55-0065D	S20-4639	
SSTJ7000	3" x 3-1/4"	XH 7TJ CR		R+	B55-0065D	S20-4317	
TJ1200	1/2 Section		All Combine 3" & 1-1/2 Systems		B55-0065D	S20-0297	

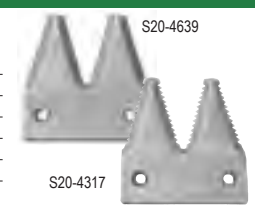

SECTION BOLTS

Description	Application	Qty. Pkg.	Qty. Mstr Ctn.	Order No.	Price
Section Bolt w/Nut	Universal - Replaces 9/16" & 5/8" OH Rivets	50	300	B55-0065D	
Section Bolt w/Nut	600 Series Flex & Rigid Headers M6-1.0x16	50		B55-0075D*	
Head Strap Bolt	600 Series Flex & Rigid Headers M6-1.0x20	11		B55-0076D*	
Head Section Bolt w/Nut	600 Series Flex & Rigid Headers M6-1.0x25	9		B55-0077D*	
Splice Bolt & Nut	600 Series Flex & Rigid Headers	20		B55-0078D*	
Assortment of Head Bolts	600 Series Flex & Rigid Headers. (6) 20 mm & (6) 25 mm	12		B55-0080D*	
Head Bolt w/Nut	Universal - Replaces 1" & 1-1/16" OH Rivets	15	90	B55-0085D	
Head Bolt w/Nut	Universal - Replaces 1-1/4" OH Rivets	12	72	B55-0095D	
Section Bolt w/Nut	Universal - Bolts for 10' Sickle w/head bolts (80 - B55-0065D, 5 - B55-0085D, 5 - B55-0095D)	90	Each	B55-0500D	
Head Bolt w/Oval Shank	600 (15 - 20 mm bolts & nuts, 10 - 25mm bolts & nuts)	50		B55-0601D**	
Section Bolt W/Oval Shank	600 Series Flex & Rigid Headers. H158341, H158343.	50		B55-0600D**	
1/2" CS Overlap Bolt	Double Drive Sickles (use with Allen Wrench) w/Low Profile Nut	10	60	B55-0059D	
Nut, Full	Universal for all above bolts	20	120	N83-0289D	
Nut, Low Profile	Overlap Sickles	20	120	N83-0295D	



RIVETS

Size / No. in Pkg.	Description	Application	Qty. Pkg.	Qty. Ctn.	Order No.	Price
5/8" # 5-1/2 (56)	OH Rivets Asst.	7' Heavy Mower Sections and Knife Heads	Asst.	6	R36-0523D	
1" # 5-1/2 (10)	Zinc Pltd.					
5/8" # 5-1/2 (72)	OH Rivets Asst.	9' Mower Conditioners	Asst.	6	R36-0524D	
1" # 5-1/2 (5)	Zinc Pltd.					
1-1/4" # 5-1/2 (5)						
1-1/4" OH	OH Rivets Zinc Plt.	Head Rivet	1/2#	3	R36-0467D	
1" OH	OH Rivets Zinc Plt.	Head Rivet	1/2#	3	R36-0465D	
1/4" x 5/8" OH	OH Rivets Zinc Plt.	For Sections H21527H, P49650	1#	6	R36-0480D	
5/8" OH	OH Rivets Zinc Plt.	Heavy Gauge Sections	1#	6	R36-0462D	
9/16" OH	OH Rivets Zinc Plt.	Heavy Gauge Sections	1#	6	R36-0461D	
1/2" OH	OH Rivets Zinc Plt.	Regular Gauge Sections	1#	6	R36-0521D	
15/16" OH	OH Rivets Zinc Plt.	Head Rivet	1/2#	3	R36-0522D	
1-1/4" CS	CS Rivets Zinc Plt.	Guard Plate Rivet	1/2#	3	R36-0468D	
1" CS	CS Rivets Zinc Plt.	Head Rivet	1/2#	3	R36-0466D	
1/2" CS	CS Rivets Zinc Plt.	Section Rivet	1#	6	R36-0464D	
5/8" CS	CS Rivets Zinc Plt.	Section Rivet	1#	6	R36-0463D	



SICKLES

MOWERS 2, 5, 7B, 7D, 8, 8W, 9, 9W, 11, 20A, 37, 38, 39, 39N, 51

OEM #	Length	No. Of Sections	Head	Head OEM #	Type	Section	Section OEM #	Riveted Order No	Riveted Price	Bolted Order No	Bolted Price
AZ958H, AZ3987H	7'	28	H15-0282	AZ955H, H28076	XHSM	S20-1142	E76372, Z6451H	S35-3725		-	
AZ1299H	7'	28	H15-0282	AZ955H, H28076	XHUS	S20-5246	E76373, Z7030H	S35-3548		S35-1288	
AZ3104H	7'	28	H15-0282	AZ955H, H28076	XHUSCR	S20-6344	E76371, H21530H	S35-4242		-	
AZ3987H	9'	36	H15-0282	AZ955H, H28076	XHSM	S20-1142	E76372, Z6451H	S35-3587		-	
AZ3988H	9'	36	H15-0282	AZ955H, H28076	XHUS	S20-5246	E76373, Z7030H	S35-3588		-	

MOWERS 47, 50, 250, 350, 450, 3700 WITH NEEDLE BEARING STYLE HEAD

OEM #	Length	No. Of Sections	Head	Head OEM #	Type	Section	Section OEM #	Riveted Order No	Riveted Price	Bolted Order No	Bolted Price
AE48592, AE36097	7'	28	H15-0335	AE35450, AE47891, AE48587	XHUS	S20-5246	E76373, Z7030H	S35-3004		-	
AE48593, AE36101	7'	28	H15-0335	AE35450, AE47891, AE48587	XHSM	S20-1142	E76372, Z6451H	S35-3001		-	
SSAE48593, SSAE36101	7'	28	H15-0335	AE35450, AE47891, AE48587	XH7TSCR	S20-4286	SSE45996, SSE76370	-		S35-2455	
AE48594, AE36102	9'	36	H15-0335	AE35450, AE47891, AE48587	XHUS	S20-5246	E76373, Z7030H	S35-3003		S35-1709	
AE48595, AE36106	9'	36	H15-0335	AE35450, AE47891, AE48587	XHSM	S20-1142	E76372, Z6451H	S35-3002		-	
AE48594, AE36102	9'	36	H15-0335	AE35450, AE47891, AE48587	XHTS	S20-3996	E76370, E45996	S35-3005		-	

MOWER CONDITIONERS 480, 483, 485, 780, 800 BOTH WITH 78 DRAPER HEADER, 1209 S/N 285000-EARLIER, 2280, 2320, 2420 ALL THREE WITH 240 AUGER HEADER TIE ROD HEAD STYLE

OEM #	Length	No. Of Sections	Head	Head OEM #	Type	Section	Section OEM #	Riveted Order No	Riveted Price	Bolted Order No	Bolted Price
AE27602	9'	37	Headless	AE24247	XHTSCR	S20-4777	E45996, E76370	S35-4354		-	
AE27623	9'	37	Headless	AE24247	XHUSCR	S20-6344	E76371, H21530H	S35-4353		-	

WINDROWERS 780, 800, 830, 880, 1214, 2250, 2270 USING PLATFORMS 78, 88, 120, 183, 188, 220, 278, 288 TIE ROD HEAD STYLE

OEM #	Length	No. Of		Head	Head OEM #	Type	Section	Section OEM #	Riveted Order No	Riveted Price	Bolted Order No	Bolted Price
		Sections	Head									
AE28067	12'	49		Headless	AE24247	XHTSCR	S20-4777	E45996, E76370	S35-4350		-	
AE28073	14'	57		Headless	AE24247	XHTSCR	S20-4777	E45996, E76370	S35-4351		-	
AE23898, AE30976	15'	59		Headless	AE24247	XHTSCR	S20-4777	E45996, E76370	S35-4751		-	
AE23782, AE32932	18'	71		Headless	AE24247	XHTSCR	S20-4777	E45996, E76370	S35-4752		-	

WINDROWERS 4890 DOUBLE DRIVE, 4895, 4995 SELF- PROPELLED USING 890, 895, 896 AUGER PLATFORMS

OEM #	Length	No. Of		Head	Head OEM #	Type	Section	Section OEM #	Riveted Order No	Riveted Price	Bolted Order No	Bolted Price
		Sections	Head									
AE51995, AE57037	14' LH	29		H15-0417	AE54468	XH7TSCR	S20-4286	SSE45996, SSE76370	-		S35-2330	
AE51996, AE57038	14' RH	29		H15-0417	AE54468	XH7TSCR	S20-4286	SSE45996, SSE76370	-		S35-2332	
AE51795, AE57039	16' LH	33		H15-0417	AE54468	XH7TSCR	S20-4286	SSE45996, SSE76370	-		S35-2331	
AE51796, AE57040	16' RH	33		H15-0417	AE54468	XH7TSCR	S20-4286	SSE45996, SSE76370	-		S35-2334	
AE51997, AE57041	18' LH	37		H15-0417	AE54468	XH7TSCR	S20-4286	SSE45996, SSE76370	-		S35-2333	
AE51998, AE57042	18' RH	37		H15-0417	AE54468	XH7TSCR	S20-4286	SSE45996,	-		S35-2335	

WINDROWERS 1207, 1209 S/N 285000-LATER, 1217, 1219

OEM #	Length	No. Of		Head	Head OEM #	Type	Section	Section OEM #	Riveted Order No	Riveted Price	Bolted Order No	Bolted Price
		Sections	Head									
AE34769, AE41758 AE48664	9'	37		H15-0362* Riveted H15-0786* Bolted	AE48125	XHTSCR XH7TSCR	S20-4777	E76370, E45996	S35-4873		-	
AE41703, AE48662	9'	37			AE48125	XHUSCR	S20-6344	E76371, H21530H	S35-4868		S35-2012 S35-2526	S35-2936

WINDROWERS 2280, 2320, 2420 USING 230, 240 AUGER PLATFORM OR 130, 135 DRAPER HEADER

OEM #	Length	No. Of		Head	Head OEM #	Type	Section	Section OEM #	Riveted Order No	Riveted Price	Bolted Order No	Bolted Price
		Sections	Head									
SSAE34769, SSAE41758 SSAE48664	9'	37		H15-0786*	AE48125	XH7TSCR	S20-4286	SSE45996, SSE76370	-		S35-2012	
SSTTAE34769, SSTTAE41758 SSAE48664	9'	38		H15-0788*	TTAE48125	XH7TSCR	S20-4414	SSTTE45996, SSTTE76370	-		S35-2380	
AE34769, AE41758 AE48664	9'	37		H15-0362*	AE48125	XHTSCR	S20-4777	E76370, E45996	S35-4873		-	
AE41703, AE48662	9'	37		H15-0362* Riveted H15-0786* Bolted	AE48125	XHUSCR	S20-6344	E76371, H21530H	S35-4868		S35-2936	
SSAE34769, SSAE1758 SSAE48664	9'	37		H15-0786*	AE48125	XH7TSCR	S20-4286	SSE45996, SSE76370	-		S35-2012	
SSTTAE34769, SSTTAE41758 SSTTAE48664	9'	38		H15-0788*	TTAE48125	XH7TSCR	S20-4414	SSTTE45996, SSTTE76370	-		S35-2380	
AE35791, AE48652	12'	49		H15-0362* Riveted H15-0786* Bolted	AE48125	XHTSCR	S20-4777	E76370, E45996	S35-4133		S35-2290	
AE35809, AE48654	14'	57		H15-0362* Riveted H15-0786* Bolted	AE48125	XHTSCR	S20-4777	E76370, E45996	S35-4131		S35-2711	
AE35846, AE48657	16'	65		H15-0362*	AE48125	XHTSCR	S20-4777	E76370, E45996	S35-4132		-	
SSAE35846, SSAE48657	16'	65		H15-0786*	AE48125	XH7TSCR	S20-4286	SSE45996, SSE76370	-		S35-2460	
AE31931, AE48599	18'	71		H15-0362*	AE48125	XHTSCR	S20-4777	E76370, E45996	S35-4852		-	
SSAE31931, SSAE48599	18'	71		H15-0786*	AE48125	XH7TSCR	S20-4286	SSE45996, SSE76370	-		S35-2461	
AE28115, AE48598	21'	83		H15-0362*	AE48125	XHTSCR	S20-4777	E76370, E45996	S35-4853		-	
SSAE28115, SSAE48598	21'	83		H15-0786*	AE48125	XH7TSCR	S20-4286	SSE45996, SSE76370	-		S35-2462	

MOWER CONDITIONERS 1380 MID-PIVOT HYDRO SHIFT, 1424

OEM #	Length	No. Of Sections	Head	Head OEM #	Type	Section	Section OEM #	Riveted Order No	Riveted Price	Bolted Order No	Bolted Price
AE35791, AE48652	12'	49	H15-0362* Riveted H15-0786* Bolted	AE48125	XHTSCR	S20-4777	E76370, E45996	S35-4133		S35-2290	
AE35809, AE48654	14'	57	H15-0362* Riveted H15-0786* Bolted	AE48125	XHTSCR	S20-4777	E76370, E45996	S35-4131		S35-2711	
SSTTAE35791, SSTTAE48652	12'	50	H15-0788*	TTAE48125	XH7TTCR	S20-4414	SSTTE45996, SSTTE76370	-		S35-2381	

MOWER CONDITIONERS 1525, 3430, 3830 ALL USING 300 TWIN KNIFE HEAD, 1600, 1600A BOTH USING 300 AUGER PLATFORM

OEM #	Length	No. Of Sections	Head	Head OEM #	Type	Section	Section OEM #	Riveted Order No	Riveted Price	Bolted Order No	Bolted Price
AE43511, AE48135	14' RH	28	H15-0363*	AE48126	XHTSCR	S20-4777	E76370, E45996	S35-4138		-	
SSAE43511, SSAE48135	14' RH	28	H15-0787*	AE48126	XH7TSCR	S20-4286	SSE45996, SSE76370	-		S35-2300	
AE43520, AE48131	14' LH	29	H15-0362*	AE48125	XHTSCR	S20-4777	E76370, E45996	S35-4139		-	
SSAE43520, SSAE48131	14' LH	29	H15-0786*	AE48125	XH7TSCR	S20-4286	SSE45996, SSE76370	-		S35-2301	
AE43510, AE48134	16' RH	32	H15-0363*	AE48126	XHTSCR	S20-4777	E76370, E45996	S35-4140		-	
SSAE43510, SSAE48134	16' RH	32	H15-0787*	AE48126	XH7TSCR	S20-4286	SSE45996, SSE76370	-		S35-2021	
AE43519, AE48130	16' LH	33	H15-0362*	AE48125	XHTSCR	S20-4777	E76370, E45996	S35-4141		-	
SSAE43519, SSAE48130	16' LH	33	H15-0786*	AE48125	XH7TSCR	S20-4286	SSE45996, SSE76370	-		S35-2020	
SSTTAE43511, SSTTAE48135	14' RH	28	H15-0789*	TTAE48125	XH7TTCR	S20-4414	SSTTE45996, SSTTE76370	-		S35-2391	
SSTTAE43520, SSTTAE48131	14' LH	30	H15-0788*	TTAE48125	XH7TTCR	S20-4414	SSTTE45996, SSTTE76370	-		S35-2390	

MOWER CONDITIONERS 710, 720, 820

OEM #	Length	No. Of Sections	Head	Head OEM #	Type	Section	Section OEM #	Riveted Order No	Riveted Price	Bolted Order No	Bolted Price
SSAE49203	9' 9"	39	H15-0406	AE49854	XH7TSCR	S20-4286	SSE45996,	-		S35-2270	

WINDROWERS 580, 590 PULL-TYPE, 2360 USING 160 DRAPER HEADER

OEM #	Length	No. Of Sections	Head	Head OEM #	Type	Section	Section OEM #	Riveted Order No	Riveted Price	Bolted Order No	Bolted Price
AW25029, CXM38634	18'	71	Headless	-	XHTSCR	S20-4097	W35888, W36402	-		S35-2023	
AW25057, CXM30669	25'	99	Headless	-	XHTSCR	S20-4097	W35888, W36402	-		S35-2025	
AW25058	30'	119	Headless	-	XHTSCR	S20-4097	W35888, W36402	-		S35-2026	
SSAW20651, SSCXM15191 SSCXM38634	18'	71	Headless	-	XH7TSCR	S20-4398	SS34390CR	-		S35-2262	
SSAW20652, SSAW25030 SSCXM43074 SSCXM49667	21'	83	Headless	-	XH7TSCR Tiger Shark™	S20-4398 S20-8398	SS34390CR	-		S35-2253 S35-2553	
SSAW20653	4'	16	Headless	-	XH7TSCR	S20-4398	SS34390CR	-		S35-2254	
SSAW24760, SSAW24762 SSAW25058	9'	36	Headless	-	XH7TSCR	S20-4398	SS34390CR	-		S35-2255	

COMBINES 3300, 4400, 4420, 6600, 6620, 7700, 7720, 8820 USING 200 SERIES RIGID HEADERS OR 213-230 FLEXHEAD PLATFORM, 9400, 9500, 9600 USING 900 SERIES RIGID HEADERS

OEM #	Length	No. Of Sections	Head	Head OEM #	Type	Section	Section OEM #	Riveted Order No	Riveted Price	Bolted Order No	Bolted Price
AH121076, AH140382	13'	50	H15-0004	AH121075	XH7TSCR	S20-4267	SSH84415, SSH130478	-		S35-2536	
AH128721	16'	62	H15-0004	AH121075	XH7TSCR	S20-4267	SSH84415, SSH130478	-		S35-2538	
AH121081	20'	78	H15-0004	AH121075	XH7TSCR	S20-4267	SSH84415, SSH130478	-		S35-2540	
AH121085	24'	94	H15-0004	AH121075	XH7TSCR	S20-4267	SSH84415, SSH130478	-		S35-2542	
AH121221	25'	100	H15-0004	AH121075	XH7TSCR	S20-4267	SSH84415, SSH130478	-		S35-2108	
N/A	6' Ext. w/splice	24	Headless	N/A	XH7TSCR	S20-4267	SSH84415, SSH130478	-		S35-2543	

TIGER JAW 200 & 900 SERIES RIGID & FLEX

OEM #	Length	No. Of Sections	Head OEM #	Type	Section	Section OEM #	Riveted Order No	Riveted Price	Bolted Order No	Bolted Price
TJS25-JD900	25'	102	TJAH89498HD	XH7TSCR	S20-4317	SSTJ7000	-		S35-2076	

TOLL FREE ORDERS 1-800-247-2167

SPLICED SICKLES FOR COMBINES WITH QUICK-TACH RIGID HEADER, 200 & 900 SERIES FLEX HEADER

If Head Required: Order #H15-0395 for Quick-Tach Rigid Headers. Order #H15-0004 for 200 & 900 Series Flex Headers.
Note: For Sickles 16' or longer, use (1) S78-0005 Reinforcement Strap

WITH SUPER 7® CHROME SECTIONS

OEM #	Length	# Of Sections	Cut-Off Section	8' Segment S35-2734	7.5' Head End S35-2733	6' Segment S35-2732	Order No.	Price
SPLAH121076	13'	50	4	-	1	1	S35-2735	
SPLAH121077	15'	60	2	1	1	-	S35-2736	
SPLAH128721	16'	62	0	1	1	-	S35-2737	
SPLAH121079	18'	70	8	-	1	2	S35-2738	
SPLAH121081	20'	78	0	-	1	2	S35-2739	
SPLAH121083	22'	86	0	1	1	1	S35-2740	
SPLAH121085	24'	94	0	2	1	-	S35-2741	
SPLAH121221	25'	100	2	-	1	3	S35-2742	
SPLAH121087	30'	120	6	3	1	-	S35-2743	

WITH TOP SERRATED 14 TOOTH CHROME SECTIONS

OEM #	Length	# Of Sections	Cut-Off Section	8' Segment S35-2205	7.5' Head End S35-2204	6' Segment S35-2203	Order No.	Price
SPLAH121076	13'	50	4	-	1	1	S35-2206	
SPLAH125751	15'	60	2	1	1	-	S35-2207	
SPLAH125752	16'	62	0	1	1	-	S35-2208	
SPLAH125753	18'	70	8	-	1	2	S35-2209	
SPLAH125754	20'	78	0	-	1	2	S35-2210	
SPLAH125755	22'	86	0	1	1	1	S35-2211	
SPLAH125756	24'	94	0	2	1	-	S35-2212	
SPLAH121221	25'	100	2	-	1	3	S35-2213	
SPLAH121087	30'	120	6	3	1	-	S35-2214	

SPLICE KITS

B55-0049D



Bolts and nuts for below Splice Kits. 12 each per package.

Order No. Price

B55-0049D

Splice kit 2-1/16" hole spacing. Kit contains 2 straps along with the bolts & nuts. For 200, 900 Series headers.

Order No. Price

C83-0755

Splice kit 2" hole spacing. Kit contains 2 straps along with the bolts & nuts. Mowers & Mower Conditioners.

Order No. Price

C83-0750

Splice Kit for 600 series Herschel made sickles.

Order No. Price

C83-1600

SPLICED SICKLES FOR COMBINES WITH QUICK-TACH RIGID HEADER, 200 & 900 SERIES FLEX HEADER

*Ships Via UPS

Size	Tiger Shark™ Order No.	Price
20'	S35-8920	
22'	S35-8922	
25'	S35-8925	
30'	S35-8930	

SPLICED SICKLES FOR 600 SERIES FLEX AND RIGID HEADERS

*Ships Via UPS

Size	Tiger Shark™ Order No.	Price
20'	S35-8620	
25'	S35-8625	
30'	S35-8630	
35'	S35-8635	
40'	S35-8640	

TIGER SHARK

Shredding The Competition



The first drastically new section tooth design in decades!

- Serrated Teeth Allows More Cutting Surface.
- Stays Sharper Longer
- Lasts Longer
- Cuts Faster
- Cuts Equally Well In Soybeans, Alfalfa, Grass Hay, Wheat, Etc.

MADE IN THE USA!

SPLICED SICKLES FOR 600 SERIES FLEX & RIGID HEADERS

SUPER 7® SICKLES

Head # H15-0600 Replaces AH220051

Section Type	Length	# Of Sections	Segments							Order No.	Price
			104" HD 26 Section S35-4601	108" Mid 27 Section S35-4604	28" End 7-1/2 Section S35-4605	52" End 13-1/2" Section S35-4629	94" End 24 Section S35-4606	40" End 10-1/2 Section S35-4607	100" End 25-1/2 Section S35-4608		
XH7TSCR	20'	60-1/2	1	1	1					S35-4609	
XH7TSCR	25'	77	1	1			1			S35-4610	
XH7TSCR	30'	90-1/2	1	2				1		S35-4611	
XH7TSCR	35'	105-1/2	1	2					1	S35-4612	
XH7TSCR	40'	120.5	1	3		1				S35-4631	

WITH TOP SERRATED 14 TOOTH CHROME SECTIONS

Section Type	Length	# Of Sections	Segments							Order No.	Price
			104" HD 26 Section S35-4613	108" Mid 27 Section S35-4615	28" End 7-1/2 Section S35-4616	52" End 13-1/2" Section S35-4630	94" End 24 Section S35-4617	40" End 10-1/2 Section S35-4618	100" End 25-1/2 Section S35-4619		
XHTSCR	20'	60-1/2	1	1	1					S35-4620	
XHTSCR	25'	77	1	1			1			S35-4621	
XHTSCR	30'	90-1/2	1	2				1		S35-4622	
XHTSCR	35'	105-1/2	1	2					1	S35-4623	
XHTSCR	40'	120.5	1	3		1				S35-4632	

SICKLE HEADS AND PINS

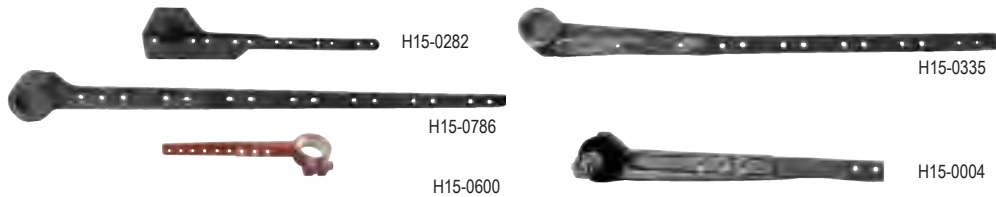

Replaces No.	Description	Application	Order No.	Price
H 28076	Sickle Head	Mowers 5, 8, 9, 11, 37, 38, 39, 39N	H15-0282	
AE48583	Sickle Head	Mowers 47, 50, 250, 350, 450, 3700 w/Needle Bearing	H15-0335	
AH220051	Sickle Head	600F, 600R. Includes nylon collar.	H15-0600	
AE54468	Sickle Head, LH & RH	890 & 4890 Double Drive Windrowers	H15-0417	
AE48125	Sickle Head L.H.	M/C 1207&1209 (S/N28500 & Up)	H15-0786	
AE34328	w/needle bearing. Bolted Sickles Only	1217, 1219 Wndrw 230,240,1380, 2280,2320, 2420, 300 Twin Knife Hdr.		
AE48125	Sickle Head L.H. w/needle bearing	M/C 1207&1209 (S/N28500 & Up)	H15-0362	
	Riveted Sickles Only	1217, 1219 Wndrw 230,240,1380, 2280,2320 & 2420 300 Twin Knife Hdr.		
AE48126	Sickle Head R.H. Bolted Sickles Only	M/C, 300 Twin Knife Windrower 2280,2320,&2420 300 Twin Knife Hdr.	H15-0787	
AE48126	Sickle Head R.H.	M/C, 300 Twin Knife Windrower,	H15-0363	
AE43506	Riveted Sickles Only	2280, 2320, 2420, 300 Twin Knife Hdr.		
AE78137	Needle Bearing & Seal	H15-0786, H15-0362, H15-0335, H15-0363, H15-0788, H15-0789, H15-0787	B15-0681B	
E78721				
AH 75308	Sickle Head & Quick Tach	Combine 3300, 4400, 6600, 6601, 6602, 7700 (Rigid) Hiniker	H15-0395	
AH 89498	Sickle Head	Combine 2000, 2002, 3300, 4400, 6600, 6601, 6602, 7700(Flex), 200 & 900 Series Headers TJ1996 & Newer	H15-0004	
AH121075, KXE10217				
TJAH89498HD	Sickle Head	Combine 200 Series & 900 Series w/Tiger Jaw Systems prior to 1996	H15-0952	
KP12A	Head Bearing Kit w/Snap Rings	Combine 200 & 900 Tiger Jaw (Fits H15-0952 Head)	B15-0659B	
TTAE48125	TT Sickle Head	M/C 1207&1209 (S/N28500 & Up), 1217, 1219	H15-0788	
TTAE34328	w/needle bearing	Wndrw 230,240,1380, 2280,2320, 2420, 300 Twin Knife Hdr.		
TTAE48126	TT Sickle Head R.H.	M/C, 300 Twin Knife Windrower	H15-0789	
TTAE43506		2280,2320,&2420 300 Twin Knife Hdr.		
TJ121KR	Reinforcement Strap	For TJ Sickles, Use (1) on 16' or longer	S78-0051	
N/A	Head Reinforcement Strap	Use (1) on 16' or longer, For Combine Sickles Except Tiger Jaw	S78-0005	
TJ432JDHP	Knife Head Pin	TJ Combine 200 & 900 Series Header. Fits H15-0952 & H15-0148	P34-0451B	

SICKLE/KNIFE BACKS

Fits Mowers 5, 8, 9, 11, 37, 38, 39

Replaces Number	Size	Order No.	Price
JD 7	7'	S35-6091	
JD 9	9'	S35-6108	

COMBINE CUTTERBAR REPLACEMENT KITS FOR 3" CUTTING SYSTEMS

Replace original 3" Systems or convert 1-1/2" Systems to 3" Systems.

Replaces STS20JD2-900. 20 Foot Kit.



Kits Include: Guards & Guard Bolts, Stamped Steel Adjustable Hold Down Clips, Wear Plates, Drive Head & UPS shippable Spliced Sickle with Bolted Chrome Super 7 Sections.

Order No.	Price
C83-0201	

DISC MOWER KNIVES

OEM Number	Application	Length Inches	Hole Dia. Inches	Style	Shape	Bolt Order No	6 Blades Order No	Price	25 Blades Order No	Price
CC19336	1314, 1315	3.66	.640"	4	LH Twisted	B55-0358D	B45-6996D		B45-6996	
CC19333		3.66	.640"	4	RH Twisted	B55-0358D	B45-6997D		B45-6997	
CC20500, CC44005	1320, 1326, 1327, 240, 260	3.76	.640"	4	LH Twisted	B55-0358D	B45-6122D		B45-6122	
CC20501, CC44006		3.76	.640"	4	RH Twisted	B55-0358D	B45-6123D		B45-6123	
CC21780	1320, 1326, 1327, 265, 270, 275, 285	4.82	.717"	4	LH Twisted	B55-0344D	B45-6565D		B45-6565	
CC21781		4.82	.717"	4	RH Twisted	B55-0344D	B45-6566D		B45-6566	
E80208	525, 530, 535, 625, 630, 635, 730, 735	4.21	.717"	4	RH Twisted		B45-6568D		B45-6568	
E80206	830, 835, 910, 915, 916, 920, 925, 926, 930, 935, 936, 945, 946, 955, 956, 990, 994, 995, 1340, 1350, 1360, 1460, 1470	4.21	.717"	4	LH Twisted		B45-6569D		B45-6569	

ROW CROP SECTION

Replaces Number	Description	Application	Pkg. Qty.	Order No.	Price
H101607	Row Crop Section	50 & 50A Series Row Crop Hdr.	12	S20-1976	
1/4" x 7/8" Gr. 8	Section Bolt w/Nut	For S20-1976	36	B55-0977D	

S20-1976

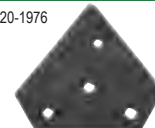

RAKE WHEELS

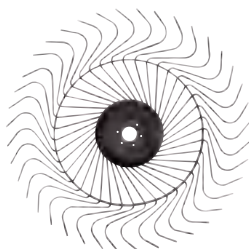

55" Diameter. Tine Diameter: Heavy-Duty .276" (7mm). Fits Tonutti/National/Walton, John Deere/Frontier, Vermeer, Kuhn, Miller Pro/Arts Way and Gehl. *Ships via Truck Freight.

Order No	Price
W16-0805 (Right)	
W16-0806 (Left)	

BALE SPEARS

BETTER QUALITY. BETTER PRICE.

BOLT ON SPEARS
Nut Included. Order Sleeve Separately.

Description	Length	Capacity	Order No.	Price
Threaded Standard Duty	32"	2500 lbs	BS32WN	
Threaded Standard Duty	43"	2500 lbs	BS43WN	
Threaded Standard Duty	49"	2500 lbs	BS49WN	
Threaded Heavy Duty	32"	3500 lbs	BS32WNHD	
Threaded Heavy Duty	43"	3500 lbs	BS43WNHD	
Threaded Heavy Duty	49"	3500 lbs	BS49WNHD	

Pin On Spears
Order Bushing/Sleeve Separately.

Description	Length	Capacity	Order No.	Price
Cross Bolt Standard Duty	43"	2500 lbs	BS43CB	
Cross Bolt Standard Duty	49"	2500 lbs	BS49CB	

* High Tensile Strength Heat Treated Steel
 * Standard Duty 2500# 1-3/4" Diameter
 * Heavy Duty 3500# 1-3/4" Diameter
 * Threaded Spears Include Nut

Assembling Advice For Square Tines
RIGHT WRONG

HOLD DOWN CLIPS

Non-Adjustable

Style	Description	Application	Order No.	Price
Steel	Hold Down Clips, Low	All Mowers	C45-0042	
Steel	Hold Down Clip, High	All Combines, Mowers	C45-0693	
Steel	Hold Down Clip Low	All Combines, Mowers	C45-0692	

C45-0693



C45-0692



Adjustable

Style	Description	Application	Order No.	Price
Cast	Lo-Arch Clip	All Mowers, Conditioners, & Swathers	C45-0006	
Cast	Hi-Arch Clip	All Mowers, Conditioners, & Swathers	C45-0007	
Cast	Clip Arch Only, Low	For C45-0006	C45-0008	
	Rubber Elastomer	For C45-0006 & C45-0007	R36-0001	
Steel	Lo-Arch	Most Combines, Mowers, & Windrowers	C45-0040	
Cast	Low Arch	600 Series. Replaces AH218547	C45-0620	
Cast	High Arch	600 Series. Replaces AH218548	C45-0625	

C45-0040



C45-0620



C45-0625



GUARDS



Replaces Number	Description	Application	Replaces OEM Number	Order No.	Price
DM 700	1-Prong, Malleable, Center	All Mowers	AZ 3441H, AZ 2131H	G81-0803	
DM 700R	1-Prong, Malleable, Outer	All Mowers	AZ 3442H, AZ2132H	G81-0805	
HA222H, FS 96-DH	Forged Steel, Dbl Heat Treated	Mower/Cond & Windrowers. 300, 300A prior to sn 943000; Mower/Cond 1217, 1218 sn 71001 & later; 1600	E72428, H113571	G81-0147	
HA220, FS 82-2	Double Prong-Forged	Mowers 37, 389, 39, 250, 350, 450. M/C 480, 483, 485. Windrowers 215, 215A, 780, 800, 880. Platform Augers 18, 19, 183, 188, 220 & 230 prior to s/n 425000. Draper platforms 78, 88 120, 130, 135	E48093, E52667, E82559 Up To 1978	G81-0185	
HA215DH, FS81DH	Double Prong. Dbl Heat Treat	Windrowers 580, 590; 140, 160 Augers		G81-0098	
HA235, FS73-2	2 Prong	Model 580, 590, 140 Auger. 160 Draper	W30341	G81-0070	
HA240A	2 Prong	200, 900 Combines	H75386, H61954	G81-0020	
HA240S	2 Prong	Quick Tach 200, 900 Series	H145791	G81-0021	
HA240A, FC 62-2A	Double Prong-Forged	Combines ALL	H145791, H75386, H61954H	G81-0191	
HA340, FC 62-3G	Triple Prong-Forged	Combines	H25603, H153855	G81-0026	
TJ44-4A	4 Prong	Tiger Jaws		G81-0581	
TJ44-6A	6 Prong	Tiger Jaws		G81-0446	
HA254	2 Prong, Non-Clog	M/C 1207, 1209, 1214, 1217, 1219, 1380, 1600,	E59625, E52547		
HA254H	Double Heat Treat	1424, 1525. Mowers 350, 450	E57752, E95625	G81-0102	
HA610	Long-Short-Long	600 Series Flex Heads	H213507, H20547, H213400	G81-0398	
HA615	Short-Long-Short	600 Series Flex Heads	H205448, H213398	G81-0399	
HA635	Long-Short-Short	600 Series Rigid & Draper Heads. 900 Series Draper Heads	H213405	G81-0396	
HA630	Short-Long-Short	600 Series Rigid & Draper Heads. 900 Series Draper Heads	H213408	G81-0397	

6" WEAR AND GUARD PLATES



Replaces Number	Description	Application	Order No.	Price
Z5110H	Guard Plate	Mowers All w/AZ3441 Guard	P44-0646	
E47954	Wear Plate	Wnrdw, Mowers, M/C & Combines	P44-0650	
H153157	Wear Plate	200 & 900 Series Platforms	P44-0655	

PITMAN WOODS



Replaces Number	Length	Application	Order No.	Price
Z 9298H, AZ2497H, AZ2956H, A23419H	33-15/16"	Mowers 5, 20, 20A	P38-0510	
Z 9913H, AZ12878H, AH16427H	26-3/4"	Mowers 8, 9	P38-0515	
H 28286H, AH16427H	36-3/4"	Mowers 8W, 9W, 37, 38, 39, 11	P38-0505	

GUARD BOLTS FOR MOWERS AND CONDITIONERS



Size / No. in Pkg.	Description	Application	Order No.	Price
7/16" x 1-3/8" (18)	Universal No. 3 Head Guard Bolt	Cutter Bars 7" or smaller	B55-0700	
7/16" x 1-11/16" (12)	Conical Nuts			
7/16" Nuts (30)				
7/16" (5)	Conical Guard Nut	Guard Bolts	N83-0593D	

GRASS BOARD

Application	Order No.	Price
Most Mowers	B52-0615	



BALE COUNTER

Reads up to 99,999, 4-hole mounting plate, push button reset, adjustable side arm. Fits most balers.

Order No.	Price
T55-0002	



RAKE / BALER / COMBINE TEETH

Replaces Number	Description	Application	Order No.	Price
186 SE, 175 SE	2 Prong, Spring	Rakes 553, 594, 594 LW(Quick Det)	T16-0320	
194SE	2 Prong, Spring	Rakes 14, 596, 597, 714 Quick Det.	T16-0325	
257 SE	1 Prong, Spring	Rakes 851, 894, 350, 858 & 896, 350, Blasers 24T, 216T	T16-0330	
E 35277	2 Prong, Spring	Rakes 567	T16-0315	
E10711, AE68906	2 Prong, Spring	M/C 1207, 1209, 1217, 1219, 1380 & AE68906 After SN 425000	T16-0332	
276 SE	2 Prong, Spring	Balers 14T, 24T, 214T, 214W	T16-0022	
E 41833	2 Prong, Spring	Balers 327, 336, 346, 337, 347, 367	T16-0024	
E61295, E67036	2 Prong, Spring	Baler 410, 430, 500, 510, 550	T16-0025	
HE1017004	2 Prong, Plastic Flex	Combine Pick-Up Tooth	T16-0050	
1/4 x 3/4 LPK, RMT-1, AE47389	1 Prong Rubber Mt. RH	Rakes 640, 650, 660, 670, 672, 662, 652, 896A	T16-0182	
EF2888001, AE56204	1 Prong Rubber Mt. RH/LH	Twin Rake 700, 705	T16-0185	
H1611	Reel Tooth (Steel)	200 Series platform w/Hume reel	T16-0124	
AE47389	1 Prong Rubber Tooth Torsion, LH	Rakes 640, 650, 660, 670, 672, 662, 652, 896A	T16-0188	



PLASTIC BEARINGS AND HARDWARE FOR PIPE REEL KITS

Description	Order No.	Price
Outside Tine Bracket. Use with T16-0730 to replace LH or RH original steel reel end fingers. Fits Herschel-Adams Reel Conversion Kits. Sold individually.	B65-0120	
Plastic Bearing Kit. Includes 6 bases, 6 caps, 6 U-bolts, & 12 nuts. Fits reels with wood bats used on JD Quick-Tach & 200 series. Also fits reels with Tear Drop Bats used on JD 900 series prior to S/N 645300. Sold 6/box.	B15-0915	
Plastic Bearing Kit. Includes 12 bearing halves, 6 bolts & 6 nuts. Fits pipe reels with Plastic Tines used on JD 900 series S/N 645300 & up. Sold 6/box.	B15-0925	



PLASTIC REEL TINES

Replaces Number	Description	Application	Pkg. Qty.	Order No.	Price
N66A	Reel Tine	Front Side of Wood Bats	100	T16-0183	
N67A	Reel Tine	Rear Side of Tear Drop Bat	100	T16-0767	
1127204	Reel Tine, 1 Prong, Steel	Used on Hume Reels.	Each	T16-0124	
782551, 1989438C1, AH136689, AH153175	2 pc. M/L Reel Tine w/clamps	Most Pipe Style Reels 4" bat.	100	T16-0720	
782226, 1989438C1, AH136689, AH153175	2 pc. M/L Reel Tine w/clamps	Most Pipe Style Reels 4" bat.	10/Bag	T16-0715	
HA100MLT	M/L Reel Tine Only Less Clamps	For T16-0720 & T16-0715	100/Box	T16-0725	
HA20SC	Replacement Screw	For ML Tines T16-0720, T16-0715	20/BB	B55-0096D	



HERSCHEL 6" 2-PIECE POLY TINES FOR PIPE REELS

Fits 900 F & R Series s/n 685101 & Up, 600 Series



Description	Pkg. Qty.	Order No.	Price
Tine & Clamp	100/Box	T16-0740	
Tine & Clamp	10/Box	T16-0745	
Tine ONLY	100/Box	T16-0750	

*PATENTED 2 PIECE DESIGN.
*SAVE MONEY!
REPLACE ONLY THE TINE.

GATHERER BELT CHAIN (2 PER ROW)

Replaces AH101172. For 50A Series Row Crop Header and 2 Row Forage Harvesters.

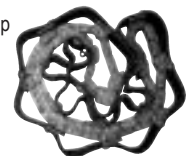

Order No.	Price
B22-0060	

AUGER FINGERS

Durable and Flexible. Replace the original metal fingers in combine augers.

Poly fingers are strong and resilient and will bend 10° past the breaking point of metal fingers. Broken metal fingers can do costly damage to rotors and cylinders by gouging or poking through the auger. A loose metal finger can cut an auger in half in 15 seconds. Poly fingers will disintegrate as they go through the combine. They are literally ground to a dust that will not damage internal working parts of the combine like rotors and cylinders.



Application	Pack Qty	Order No.	Price
Auger Finger Only, 200, 900	24 PK	P44-0101	
Auger Finger Kit, 200, 900	1 Kit	P44-0103*	
Universal Guide, 200, 600, 900	Each	P44-0115	
Auger Finger Only, 600	100 PK	P44-0116	
Auger Finger Only, 600	24 PK	P44-0117	
Auger Finger Kit, 600	12 PK	P44-0118	

*Kit includes 12 fingers, 12 guides and hardware.

POLY SKID SHOE KITS - YELLOW

- 1/4" ultra high molecular Polyethylene material is super slick and lightweight.
- The abrasion resistance of this plastic is 1.8 times greater than steel.
- Has nearly the exact same "sliding" properties as Teflon.
- Prevents losing valuable harvest days due to wet weather.
- Allows you to harvest in wet conditions or clay with no sticky build-up.
- Easy to install, just drill holes in steel plates and fasten with Hammer rivets furnished in all Kits.
- Precut and formed. All Plates come with countersunk drilled holes.
- Protects your metal skid shoes so they never wear out.
- Furnished with end plate, wobblebox plate.

Application	Head Size	Order No.	Price
200 & 900	15'	P44-2001	
200 & 900	18'	P44-2003	
200 & 900	20'	P44-2004	
200 & 900	22'	P44-2005	
200 & 900	24'	P44-2006	
900	15'	P44-1915	
900	18'	P44-1918	

Application	Head Size	Order No.	Price
900	20'	P44-1920	
900	25'	P44-1925	
900	30'	P44-1930	
600 R & F	20'	P44-1620	
600 R & F	25'	P44-1625	
600 R & F	30'	P44-1630	

POLY REPLACEMENT PARTS FOR HERSHEY SPECKLED POLY KITS

Replaces Number	Size Length x Width	Rivets Required	Qty. Required										Order No.	Price
			13'	15'	16'	18'	20'	22'	24'	25'	30'			
JOHN DEERE- 200 & 900 Series Flex to Serial #635100														
JD200-20N	16" x 20"	8	3	3	4	5	5	9	9				P44-1099	
JD200-46L	16" x 46"	15	1	1	1	1	1	1	1				P44-1100	
JD200-46R	16" x 46"	15	1	1	1	1	1	1	1				P44-1101	
SPK11-JD200EP	End Plate	7	1	1	1	1	1	1	1				P44-1120	
SPK22-JD200WB	Wobblebox Plate	7	1	1	1	1	1	1	1				P44-1124	
SPK1824-JDSP	Stabilizer Plate	7	1	1	1	1	1	1	1				P44-1203	
JOHN DEERE- 900 Series After Serial #635101														
JD900-9	9"	6			1	2	4	1		2	4		P44-1173	
JD900-18	18"	11	2	2		2		4			2		P44-1174	
JD900-205	20-1/2"	12				1			5	4	2		P44-1178	
JD900-21	20-1/2"	11	1	2		3	4	4	4	5	7		P44-1175	
JD900-46L	LH 52"	27	1	1		1	1	1	1	1	1		P44-1176	
JD900-46R	RH 50"	23	1	1		1	1	1	1	1	1		P44-1177	
SPK11-JD900EP	End Plate Long, 4" x 25" H/A Kits Mfg. Prior to 1996	7	1	1		1	1	1	1	1	1		P44-1126	
JD900-EP	End Plate, 4" x 11" H/A Kits Mfg. After 1996	3	1	1		1	1	1	1	1	1		P44-1180	
SPK22-JD900WB	Wobblebox Plate Long, 6" x 29" H/A Kits Mfg. Prior to 1996	11	1	1		1	1	1	1	1	1		P44-1127	
JD900-WB	Wobble Box Plate, 6" x 12" H/A Kits Mfg. After 1996	5	1	1		1	1	1	1	1	1		P44-1179	
SPK1824-JDSP	Stabilizer Plate	7	1	1		1	1	1	1	1	1		P44-1203	

MISCELLANEOUS POLY REPLACEMENT PARTS FOR HERSHEY SPECKLED POLY KITS

Replaces Number	Description	Application	# Rivets Required	Order No.	Price
SPK21-JDRCHLH	**21" Plate	50A Series Row Crop Hdr., New--LH	6	P44-1202	
SPK21-JDRCHRH	**21" Plate	50A Series Row Crop Hdr., New--RH	6	P44-1394	
SPK50AJDRCH	**21" Plate	50A Series Row Crop Hdr., Serial #635001 & Up, RH or LH (Order Bolts B55-0228)	4 Bolts	P44-1396	

** Rivets Must be ordered separately. Order R36-0655. *** Bolts or Hammer Rivets Must be ordered separately.

HAMMER RIVET TOOL

For Drive Rivets



Order No. T55-0812 **Price**

HAMMER RIVETS

The R36-0653 Hammer rivet is designed for use of the John Deere 900 series heads with predrilled holes, and can be used in place of the B55-0004 Torque Bolts.



Size	Description	Application	Pkg. Qty.	Order No.	Price
1/4" x 3/8"	Large Head	JD 900 Series	50/BB	R36-0653	
1/4" x 5/16"	Large Head	JD 900Series-End Plate P44-1126 & Wobble box Plate P44-1127	20/BB	R36-0654	
3/16" x 5/16"	Large Head	JD 200 Series	50/BB	R36-0655	

STRAW CHOPPER KNIFE KITS

For Combines w/new style drum w/bolt on knives. All 7720, 8820, 9400, 9500, 9600.

Set Includes	OEM Number	Order No.	Price
6 Knives	AH124635	C83-0604	
6 Bushings	H88809		
6 Nuts	H88783		
6 Bolts			

GATHERING CHAINS

Replaces OEM No.	Chain Type & Quantity	Att.Lk. Type & Qty.	Offset Links	Conn. Links	Total Links	Combine Head Application	Wt. Each	Order No.	Price
AN102009	CA555(40)	C6E(8)	None	Endless	48	243, 244, 343, 344, 443, 444,543, 546, 643, 644, 645, 842,843	9 1/2 #	C30-0120	
AN102009	CA555(40)	C6E(8)	None	-	48	243, 244, 343, 344, 443, 444,543, 546, 643, 644, 645, 842,843	9 1/2 #	C30-0121*	

*Import



GATHERING CHAIN IDLER SPROCKETS



Replaces OEM Number	Model Application	Order No.	Price
AN102448, Sealed	40 Series to S/N 466450	S62-0741	
AH101219, Relube	40 Series S/N 46451 & Up	S62-0744	
H85252	40 & 90 Series Head Drive Sprocket	S62-0723	

CORN HEAD ROLLERS



Replaces Number	Description	Order No.	Price
H104090	RH	R57-0090	
H104091	LH	R57-0091	

90 Series Head. Straight Flute			
Replaces Number	Description	Order No.	Price
H150138	RH	R57-0095	
H150139	LH	R57-0096	

High quality aftermarket chain sprockets for popular models and hard-to-find applications.

- Heat Treated
- Long Wear
- Black Paint



Order No Price

Order No Price

MAIN DRIVE SPROCKET FROM GEAR BOX

Round Balers 330, 335, 375, 430, 435, 446, 447, 448, 456, 457, 458, 466, 467, 530, 535, 546, 547, 556, 557, 558, 566, 567,
 • 17/17 Tooth, 60 Chain, 1.253" Bore
 • Replaces AE39301, AFH205784

HAE39301

LOWER DRIVE ROLLER SPROCKET #80

Round Balers 458, 468, 468s, 469, 558, 568, 569
 • 24 Tooth, 60 Chain / 30 Tooth, 80 Chain
 • Replaces AE74598, AXE15284

HAE74598

UPPER DRIVE ROLLER SPROCKET

Round Balers 330, 335, 375, 430, 435, 446, 447, 448, 449, 456, 457, 458, 466, 467, 530, 535, 546, 547, 549, 556, 557, 558, 559, 566, 567
 • 40 Tooth, 60 Chain, 1.504" Bore
 • Replaces AE39654, AFH205815

HAE39654

IDLER SPROCKET MAIN DRIVE #80

Round Balers 458, 468, 468s, 558, 568
 • 12 Tooth, 80 Chain, 1.573" Bore
 • Replaces AH216239

HAH216239

STARTER ROLLER SPROCKET

Round Balers 330, 335, 375, 385, 430, 435, 530, 535, 540, 545, 550
 • 20 Tooth, 60 Chain, 1.504" Bore
 • Replaces AE39650

HAE39650

HEADER DRIVE SPROCKET #50

Round Balers 447, 448, 457, 458, 467, 468, 468s, 540, 545, 547, 550, 557, 567, 568
 • 19 Tooth, 50 Chain, 1.253" Bore
 • Replaces AE57757

HAE57757

LOWER DRIVE ROLLER SPROCKET

Round Balers 330, 335, 375, 385, 430, 435, 449, 459, 530, 535, 540, 545, 550, 559, 569
 • 20/40 Tooth, 60 Chain, 1.504" Bore
 • Replaces AE39652

HAE39652

IDLER SPROCKET FOR HEADER DRIVE

Round Balers 224T, 224WS, 327, 328, 336, 338, 346, 347, 348, 435, 446, 447, 448, 457, 458, 458s, 466, 467, 468, 468s, 535, 540, 545, 546, 547, 550, 556, 557, 558, 567, 568
 • 11 Tooth, 50 Chain, 0.625" Bore
 • Replaces AFH205820, AE13360

HAE13360

IDLER SPROCKET FOR MEGA PICKUP w/BEARING

Round Balers 330, 335, 375, 385, 430, 435, 530, 535, 540, 545, 550
 • 40/22 Tooth, 50 Chain, 1.127" Bore
 • Replaces AE51818

HAE51818

CAM FOLLOWER BEARING FOR PICKUP REEL

Round Balers 330, 335, 375, 385, 410, 430, 435, 446, 447, 448, 449, 456, 457, 458, 459, 466, 467, 468, 468s, 510, 530, 535, 540, 545, 546, 547, 550, 556, 557, 559, 566, 567, 568, 569
 • .05" Bore
 • Replaces AE46215, AFH2040000

HAE46215

DRIVE SPROCKET FOR MEGA PICKUP

Round Balers 446, 447, 449, 456, 457, 459, 466, 467, 468, 546, 547, 556, 557, 559, 566, 567, 568, 569
 • 40 Tooth, 50 Chain, 1.253" Bore
 • Replaces AE52633

HAE52633

STARTER ROLL, LOWER GATE ROLLER BEARING

Round Balers 335, 375, 385, 435, 446, 449, 456, 459, 466, 467, 469, 535, 546, 556, 559, 566, 567, 569
 • 1-1/2" Hex. 3.3456" OD
 • Replaces AE40895

HAE4089

STARTER ROLLER SPROCKET

Round Balers 446, 447, 449, 456, 457, 459, 466, 467, 468, 546, 547, 556, 557, 559, 566, 567, 568, 569
 • 24 Tooth, 60 Chain, 1.504" Bore
 • Replaces AE54301, AFH205816

HAE54301

TOP IDLER & DRIVE ROLLER BEARING

Round Balers 430, 435, 456, 466, 467, 530, 535, 547, 556, 557, 567
 • 1-1/2" Hex. 3.5433" OD w/Cast 4-Bolt Flange
 • Replaces AE74652, AR54574, AFH206196, AE45208, AE54574, AE45038

HAE74652

LOWER DRIVE ROLLER SPROCKET

Round Balers 446, 447, 449, 456, 457, 459, 466, 467, 468, 546, 547, 556, 557, 559, 566, 567, 568
 • 40/24 Tooth, 60 Chain, 1.504" Bore
 • Replaces AE54302, AFH205819

HAE54302

IDLER, REAR GATE W/O NET WRAP, BELT STAGGERING & ARM ROLLER BEARING

Round Balers 335, 375, 430, 435, 446, 447, 449, 456, 457, 458, 458S, 459, 466, 467, 468, 468S, 469, 530, 535, 546, 547, 557, 558, 559, 566, 567, 568, 569
 • 1-1/4" Hex. 3.1496" OD
 • Replaces AE46606

HAE46606

SLIP CLUTCH FOR MEGA PICKUP

Round Balers 446, 447, 456, 457, 466, 467, 468, 468s, 546, 547, 556, 557, 566, 567, 568, 569
 • 33 Tooth, 50 Chain, 2.625" Bore, 4 Bolt, 3.307" Bolt Circle
 • Replaces E88455, FH304862

HE88455

PICKUP SUPPORT BEARING

Round Balers 330, 335, 375, 385, 430, 435, 446, 456, 466, 467, 468, 535, 555, 558, 565, 575, 580, 582, 490
 • 1-1/8" Hex. 2.8346" OD
 • Replaces AN102010

HAN102010

DRIVE SPROCKET FOR STANDARD PICKUP

Round Balers 447, 448, 449, 457, 458, 458S, 459, 467, 468, 468S, 469, 547, 567, 557, 558, 559, 568, 569
 • 40 Tooth, 50 Chain, 1.253" Bore
 • Replaces AE58632, AFH205822

HAE58632

SLIP CLUTCH SPROCKET FOR STANDARD PICKUP

Round Balers 447, 448, 457, 458, 458s, 467, 468, 468s, 547, 567, 557, 558, 568
 • 38 Tooth, 50 Chain, 2.625" Bore, 4 Bolt, 3.307" Bolt Circle
 • Replaces E96714, E131608

HE96714

PICKUP FRAME SUPPORT BEARING

Round Balers 385, 430, 435, 447, 456, 457, 458, 468, 468S, 530, 535, 567, 568
 • 1.0" Hex. 2.4409" OD
 • Replaces JD9313

HJD9313

UPPER DRIVE ROLLER SPROCKET #80

Round Balers 458, 468, 468s, 558, 568
 • 30 Tooth, 80 Chain
 • Replaces AE74596

HAE74596

STARTER & PICKUP DRIVE ROLLER

Round Balers 3335, 375, 430, 435, 446, 447, 449, 456, 457, 458, 458S, 459, 466, 467, 468, 468S, 469, 530, 535, 546, 547, 557, 558, 559, 566, 567, 568, 569
 • 1.0" Hex. 2.44" OD
 • Replaces JD8338

HJD9338

MAIN DRIVE SPROCKET GEAR BOX #80

Round Balers 458, 468, 468s, 558, 568
 • 13/13 Tooth, 80 Chain
 • Replaces AE74597

HAE74597

	G	
Guards.....		42
	O	
Overlap Kit.....		43
	S	
Sections.....		42
Sickle Assemblies.....		42 - 43
Sickle Heads.....		42
Splice Kits.....		43
Spliced Sickles		43

MACDON

SECTIONS

Replaces	Size	Description	Application	Rivet	Qty.	Order No	Price
16671	3" x 3-1/4"	XHUS	Windrowers. 1000, 2000, 3000 & 7000	5/8" OH	10	S20-5236	
16671 CR	3" x 3-1/4"	XHUSCR		5/8" OH	10	S20-6492	
22271 CR	3" x 3-1/4"	XHTSCR		5/8" OH	10	S20-4969	
23065	3" x 3-1/4"	XHTSCR-XHi Shoulder	7000 Draper & 960, 962 Header	5/8" OH	10	S20-4097	
34390CRTPCS	3" x 3-1/4"	XHTSCR-Overlap	All Double Drive Sickles	5/8" CS	10	S20-4390	
34390CR-CS	3" x 3-7/32"	XH7TSCR-CS	All Models, Overlap Area. Lo Shoulder,	5/8" CS	10	S20-4399	
129319		Tiger Shark™	Top Countersunk Holes			S20-8399	
34390CR-CS	3" x 3-7/32"	Tiger Shark™	Lo Shoulder, Bottom Countersunk Holes	5/8" CS	10	S20-8427	
	3" x 3-1/4"	Tiger Shark™	Used To Replace OEM Numbers Listed Below	5/8" OH	10	S20-8398	
102053, 158516	3" x 3-1/4"	XH7TSCR-Lo Shoulder	Mowers & Conditioners.	5/8" OH	10	S20-4398	
34390	3" x 3-1/4"	XHTS	960, 962, 963, 972, 973, 974, D50, D60, FD70, FD75 Headers	5/8" OH	10	S20-3283	
34390CR	3" x 3-1/4"	XHTSCR	922, 912, 933	5/8" OH	10	S20-4170	



SICKLE HEADS / WEAR PLATE / BUSHING

Replaces	Description	Application	Order No	Price
20388	Sickle Head	Windrowers	H15-0870	
7382	Wear Plate, 6"	Windrowers	P44-0417	
34388	Head L.H.	7000 Auger, 5000, 910, 920, 930, 940	H15-0132	
34895	Head R.H.	7000 Auger, 910, 920, 930, 940	H15-0133	

2 PRONG GUARDS - FORGED

Replaces	OEM #	Order No	Price
FS73-2, BU235, 8420, HA235	K84205, K16716-1	G81-0070	
FS 81-2, HA215	23064, 28013, 118344	G81-0155	
BU215DHC. Center Guard, Dbl Heat Treat	28013, 124338	G81-0093	
HA215M	23064, 28013, 118344.	G81-0097	
HA250, FS86-2	34359, 2-Prong	G81-0120	

Fits 3000, 3020, 4000, 5000, 5010, 5020, 7000, 8000, 9000 series windrowers and mower conditioners 960, 962, 963, 972, 973, 974, D50, D60, FD70 Drapers: 910, 912, 920, 922, 930, 942, A30S, A30D, A40D Auger Headers.

SICKLE ASSEMBLIES - BOLTED

Replaces	Description	Section	Head	Order No	Price
BN73304	18' XH TS CR (71)	23065	Less Head	S35-2023	
BN33746	25' XH TS CR (99)	23065	Less Head	S35-2025	
BN33747	30' XH TS CR (119)	23065	Less Head	S35-2026	
BN34393CR	14' XH TS CR (57)	34390CR	Less Head	S35-2028	
BN34394CR	16' XH TS CR (65)	34390CR	Less Head	S35-2029	
BN33718CR	7' RH XH TS CR (29)	34390CR	Less Head	S35-2032	
BN33715CR	7' LH XH TS CR (29)	34390CR	Less Head	S35-2031	
BN33719CR	8' RH XH TS CR (33)	34390CR	Less Head	S35-2034	
BN33716CR	8' LH XH TS CR (33)	34390CR	Less Head	S35-2033	

SICKLE ASSEMBLIES - BOLTED WITH SUPER 7 SECTIONS

• Full length and spliced sickles • Low shoulder • Super 7 top serrated chrome sections

Replaces	Size	Application	Section #	Head #	Order No	Price
36931	9'	4000 9' Single Drive	SS34390CR	Less Head	S35-2257	
34181	12'	5020, 5000, 7000 Auger Header, 12' Single Drive, 912	SS34390CR	Less Head	S35-2258	
34182	14'	5020, 5000, 7000 Auger Header, 14' Single Drive, 912	SS34390CR	Less Head	S35-2259	
34183	16'	5020, 5000, 7000 Auger Header, 16' Single Drive, 912	SS34390CR	Less Head	S35-2260	
33704	18'	7000, 18' Draper Header, Single Drive	SS34390CR	Less Head	S35-2262	
33705	21'	7000, 21' Draper Header, Sgl. Drive, Also Used on 25' & 30' Models	SS34390CR	Less Head	S35-2253	
43076	4' Ext.	7000, 25' Draper Header, Sgl. Drive, Sickle Extn., Use With S35-2253	SS34390CR	Less Head	S35-2254	
43077	9' Ext.	7000, 30' Draper Header, Sgl. Drive, Sickle Extn., Use With S35-2253	SS34390CR	Less Head	S35-2255	
34181	12'	910,920, 930, 12' Single Drive	SS34390CR	Less Head	S35-2258	
34182	14'	910,920, 930, 14' Single Drive	SS34390CR	Less Head	S35-2259	
34183	16'	910,920, 930, 16' Single Drive	SS34390CR	Less Head	S35-2260	
155063	7'RH	910,920,922, 930, 14' 7000 Auger Header, Dbl. Drive w/Std. Guards	SS34390CR	Less Head	S35-2241	
155062	7' LH	910,920,922, 930, 14' 7000 Auger Header, Dbl. Drive w/Std. Guards	SS34390CR	Less Head	S35-2240	
155065	8'RH	910,920,922, 930, 16' 7000 Auger Header, Dbl. Drive w/Std. Guards	SS34390CR	Less Head	S35-2243	
155063	8' LH	910,920,922, 930, 16' 7000 Auger Header, Dbl. Drive w/Std. Guards	SS34390CR	Less Head	S35-2242	
155069	7' LH	932 14' Dbl. Drive, Auger Header, 922, 933	SS34390CR	Less Head	S35-2281	
155064	7' RH	932 14' Dbl. Drive, Auger Header, 922, 933	SS34390CR	Less Head	S35-2282	
38633	15'	940 15' Single Drive	SS34390CR	Less Head	S35-2266	
38634	18'	940 18' Single Drive	SS34390CR	Less Head	S35-2249	
47783	8'RH	942 15' Double Drive	SS34390CR	Less Head	S35-2250	
34211	7' LH	942 15' Double Drive	SS34390CR	Less Head	S35-2240	
155067	9'RH	942 18' Double Drive	SS34390CR	Less Head	S35-2252	
155066	9' LH	942 18' Double Drive	SS34390CR	Less Head	S35-2251	
43074	21'	960, 21', Also used on 25', 30' & 36' Models. 962, 963, 3000, 3020	SS34390CR	Less Head	S35-2253	
43076	4' Ext.	960 25' Sickle Extension, Use w/ S35-2253, 962, 963, 3000, 3020	SS34390CR	Less Head	S35-2254	
43077	9' Ext.	960 30' Sickle Extension, Use w/ S35-2253, 962, 963, 3000, 3020	SS34390CR	Less Head	S35-2255	
43078	15' Ext.	960 36' Sickle Extension, Use w/ s35-2253, 962, 963, 3000, 3020	SS34390CR	Less Head	S35-2256	
118443	10.5' LH	972 21' Dbl. Drive	SS34390CR	Less Head	S35-2350	
118395	10.5' RH	972 21' Dbl. Drive	SS34390CR	Less Head	S35-2351	
118494	12.5' LH	972 25' Dbl. Drive	SS34390CR	Less Head	S35-2352	
118397	12.5' RH	972 25' Dbl. Drive	SS34390CR	Less Head	S35-2353	
118441	15' LH	972 30' Dbl. Drive	SS34390CR	Less Head	S35-2357	
118448	15' RH	972 30' Dbl. Drive	SS34390CR	Less Head	S35-2358	
124926	16' RH	D50, D6, Rigid Draper Head. 25', 30', 35' Same as IH 2142 & 2152	SS34390CR	Less Head	S35-2120	
124923	16" LH	FD70 Flex Draper Head. 30', 35', 40' Same as IH 2162. A40D Auger Head	SS34390CR	Less Head	S35-2121	
	20.5" LH	CNH 2162 Double Drive Grain Head. FD70 40' Sickle	SS34390CR	Less Head	S35-2130	
	20" RH	CNH 2162 Double Drive Grain Head. FD70 40' Sickle	SS34390CR	Less Head	S35-2131	

TOLL FREE ORDERS 1-800-247-2167

SICKLE ASSEMBLIES - RIVETED

Replaces Number	Size	Description Section / No. Used	Application	Section Number	Head Number	Order No	Price
15191	18'	XHTSCR (72)	Windrowers, 1000, Prairie-Mac	22271 CR	Less Head	S35-4048	
17662	21'	XHTSCR (84)		22271 CR	Less Head	S35-4049	
18132	25'	XHTSCR (100)		22271 CR	Less Head	S35-4928	
22262	15'	XHUSCR (59)	Windrowers, 2000, Hvdro-Mac	16671 CR	20388	S35-4876	
22258	15'	XH TSCR (59)		22268 CR	20388	S35-4737	
22263	18'	XHUSCR (71)		16671 CR	20388	S35-4877	
22259	18'	XHTSCR (71)		22271 CR	20388	S35-4058	
22264	21'	XHUSCR (83)	Windrowers 3000	16671 CR	20388	S35-4878	
22260	21'	XHTSCR (83)		22271 CR	20388	S35-4059	
33705	21'	XHUSCR (83)		16671 CR	Less Head	S35-4103	
33746	25'	XHUSCR (99)		16671 CR	Less Head	S35-4104	
33747	30'	XHUSCR (119)		16671 CR	Less Head	S35-4105	

SICKLE SPLICE KIT

For Spliced Sickles. 2-1/8" c-c holes. Includes Splice Bar, Bolts, & Nuts. Bolt kit includes 10 csk bolts and nuts.

Replaces Number	Order No	Price
43206	C83-0401	
Bolt Kit	B55-0049D	

KNIFE CLIP

Replaces 87458207. Used on D50, D60, FD70 & FD75 Headers



Bag of 20. Order No C45-0050

SPLICED COMBINE SICKLES

*Ships Via UPS

Model	Size	Drive	14-Tooth		Tiger Shark™	
			Order No.	Price	Order No.	Price
962/963	30	Single	S35-2181		S35-2879	
	36	Single	S35-2182		S35-2880	
972	21	Single	S35-2183		S35-2881	
	25	Single	S35-2184		S35-2882	
	30	Single	S35-2181		S35-2879	
	36	Single	S35-2182		S35-2880	
	21	Double	S35-2185		S35-2883	
	25	Double	S35-2186		S35-2884	
	30	Double	S35-2187		S35-2885	
	36	Double	S35-2188		S35-2886	
D50,D60,D65,FD70	20	Single	S35-2189		S35-2887	
	25	Single	S35-2184		S35-2882	
D50,D60,D65,FD70,FD75	30	Single	S35-2181		S35-2879	
	35	Single	S35-2190		S35-2888	
	40	Single	S35-2191		S35-2893	
D50,D60,D65,FD70	20	Double	S35-2192		S35-2894	
	25	Double	S35-2193		S35-2895	
D50,D60,D65,FD70,FD75	30	Double	S35-2194		S35-2896	
	35	Double	S35-2195		S35-2897	
	40	Double	S35-2196		S35-2898	
	45	Double	S35-2197		S35-2899	

All sickles are made bolted and headless with extra heavy chrome sections. All segments are less than 108" to ship UPS.

TIGER SHARK
Shredding The Competition



The first drastically new section tooth design in decades!

- Serrated Teeth Allows More Cutting Surface.
- Stays Sharper Longer
- Lasts Longer
- Cuts Faster
- Cuts Equally Well In Soybeans, Alfalfa, Grass Hay, Wheat, Etc.

MADE IN THE USA!

MACDON

WHY BUY ANYWHERE ELSE WHEN YOU CAN BUY FACTORY DIRECT!

We offer a complete line of harvesting parts and tillage tools that will help keep you in the field.

1-Year Guarantee On All Parts!

DISC MOWER KNIVES

See pages 105 - 109 for a complete listing of our disc mower knives.



- Meets or Exceeds ISO 5718 Standards.
- Edges Are Formed, Not Ground To Prevent Chipping or Breaking.
- Made From USA 10B38(Boron) Steel.
- Entire Blade Is Heat-Treated to a RC Hardness of 45-52.



B

Bale Counter.....	50
Baler Teeth.....	50
Bearings, Plastic Reel.....	50
Bolt-N-Clip Kit.....	47
Bolts, Section.....	47

C

Chains, Gathering.....	51
Clips, Hold Down.....	49
Combine Teeth.....	50
Corn Head Parts.....	50

D

Disc Mower Knives.....	49
------------------------	----

E

End Sections.....	47
-------------------	----

G

Gathering Chain.....	51
Gathering Chain Sprockets.....	51
Grass Board.....	50
Guard Bolts.....	49
Guards.....	49

H

Hammer Rivets.....	51
Hammer Rivet Tool.....	51
Hold Down Clips.....	49

K

Kits, Bolt-N-Clip.....	47
Kits, Poly Skid Shoe.....	50
Kits, Straw Chopper Knife.....	51

P

Pitman Woods.....	50
Plastic Reel Bearings.....	50
Poly Replacement Parts.....	50
Poly Skid Shoe Kits.....	50

R

Rake Teeth.....	50
Reel Tines.....	50
Replacement Parts, Poly.....	50
Rivets, Hammer.....	50
Rivets, Section.....	47

S

Sections.....	47
Section Bolts.....	47
Section Rivets.....	47
Sickle Assemblies.....	48 - 49
Sickle Heads.....	49
Skid Shoe Kits.....	50
Sprockets, Gathering Chain.....	51
Straw Chopper Knife Kit.....	51

T

Teeth, Baler.....	50
Teeth, Combine.....	50
Teeth, Rake.....	50
Tines, Reel.....	50

W

Wear Plate.....	49
-----------------	----

SECTION TYPE ABBREVIATIONS

Section Finish	Section Type	Section Thickness
CR = Chrome	7TS = Super 7 Top Serrated SM = Smooth US = Under Serrated TS = Top Serrated TT = Tiger Tooth TJ = Tiger Jaw	XH = Extra Heavy .116

All sections in packages of 10
*Sold in packages of 2

SECTIONS

Conventional / Tiger Jaws / Super 7

Replaces Number	Size	Description	Application	Section Design	Rivet Used	Order No.	Price
L 1262	3" x 3 1/4"	XHUS	Mowers 30, 31, 32, 51, 52,	C-	5/8 OH	S20-5236	
130356M1	3" x 3 1/4"	XHUS	71, 135, 238, M.H.5.6, 40,	C-	5/8 OH	S20-5743	
669807M1	3" x 3 1/4"	XHUSCR	41, 60,	C-	5/8 OH	S20-6710	
1036362M1	3" x 3 1/4"	XHUS	Mower/Cond	B-	5/8 OH	S20-5107	
1038969M1	3" x 3 1/4"	XHSM	Haytender 81, 725 & 925		5/8 OH	S20-1145	
683936M1	3" x 3 1/4"	XHTSCR	(Badger)	B	5/8 OH	S20-4277	
683937M1	3" x 3 1/4"	XHUSCR		B-	5/8 OH	S20-6339	
683938M1	3" x 3 1/4"	XHSMCR			5/8 OH	S20-2758	
1041472M1	3" x 3 1/4"	XHUSCR	Windrowers 655 & 35	C-	5/8 OH	S20-6492	
1046779M1	3" x 3 1/4"	XHTSCR	675,775, 875	C	5/8 OH	S20-4969	
1071707M1	3" x 3 1/4"	XHTS	Windrowers	C	5/8 OH	S20-3283	
1055090M1	3" x 3 1/4"	XHTS CR X-Hi Shoulder	Windrowers 785, 885	F	5/8 OH	S20-4097	
SS261431M1H	3" x 3 1/4"	XH7TSCR	All Combines	G+	5/8 OH	S20-4269	
1053209M1	3" x 2 1/2"	XHTSCR	Comb.Fl.Bar - Wob. Dr. Hd.	H	5/8 CS	S20-4462	
SS277444	3" x 2 1/2"	XH7TSCR	ALL Combines w/floating bar	H+	5/8 CS	S20-4322	
TJ6000	3" x 3 1/4"	XHTJCR	Combines w/Tiger Jaws	S	TJ 55BN	S20-4638	
SSTJ6000	3" x 3 1/4"	XH7TSCR	Tiger Jaw Combines	S+	TJ 55BN	S20-4316	
261431M1H	3" x 3 1/4"	XHTSCR	Windrowers 34, 36, 44	G	TJ 55BN	S20-4676	
160254M1							
146503M1							
3725570M1	3" x 3 1/4"	Tiger SharkTM	Swathers 200, 210			S20-8396	



MASSEY

UNIVERSAL END SECTIONS

HERSCHEL "End Sections" are made of heat-treated steel for rugged use. They are punched with an oblong hole to virtually fit any standard cutterbar mower in use today. To install our "End Section", simply take off the last section on the shoe end of your sickle assembly and replace it with an "End Section". The change-over takes only a couple of minutes to complete and you will notice a big difference in time saved from unclogging your mower. We recommend using R36-0523D oval head rivet or B55-0065D Bolt.

For All Mowers, Mower Conditioners & Windrowers w/Standard Cutterbar

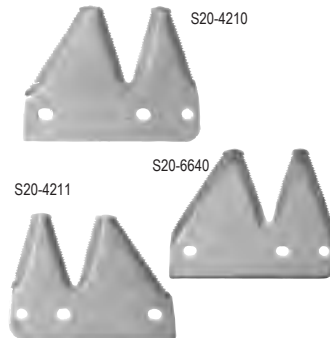

Description	Order No.	Price	Description	Order No.	Price
XH7TSCR (RH) 10/Box	S20-4403		XHTS CR (RH) 2/SP	S20-4210D	
XH7TSCR (RH) 2/SP	S20-4403D		XHTSCR (LH) 10/Box	S20-4211	
XH7TSCR (LH) 10/Box	S20-4445		XHTSCR (LH) 2/SP	S20-4211D	
XH7TSCR (LH) 2/SP	S20-4445D		XHUSCR (RH) 10/Box	S20-6640	
XHTS CR (RH) 10/Box	S20-4210		XHUSCR (RH) 2/SP	S20-6640D	

SECTION BOLTS WITH NUT

Description	Application	Qty. Pkg.	Qty. Ctn.	Order No.	Price
Section Bolt	Replaces 9/16" & 5/8" OH Rivets	50	300	B55-0065D	
Head Bolt	Replaces 1" & 1 1/16" OH Rivets	15	90	B55-0085D	
Head Bolt	Replaces 1-1/4" OH Rivets	12	72	B55-0095D	
Section Bolt	Bolts for 10' Sickle w/head bolts (80 -B55-0065D, 5 - B55-0085D 5-B55-0095D)	90	Each	B55-0500D	
Nut	Fits All Above Bolts	20	120	N83-0289D	

BOLT-N-CLIP KIT

For Most Sickles up to 10'. Converts most sickle bars to bolt-on sections.

Kit includes: Hold Down Clips, Section Bolts & Lock Nuts.

Order No. B55-0629 Price



DISPLAY PACK RIVETS - ZINC PLATED

Size/No. in Pkg.	Description	Application	Qty. Pkg.	Mstr. Ctn.	Order No.	Price
5/8" # 5-1/2 (56)	Oval Head Asst.	7' Heavy Mower Sections and Knife Heads	Asst.	6	R36-0523D	
1" # 5-1/2 (10)						
5/8" # 5-1/2 (72)	Oval Head Asst.	Mower Conditioners	Asst.	6	R36-0524D	
1" # 5-1/2 (5)						
1-1/4" # 5-1/2 (5)						
1/2" OH #5-1/2	Oval Head	Regular Gauge Sections	1#	6#	R36-0521D	
9/16" OH #5-1/2	Oval Head	Heavy Gauge Sections	1#	6#	R36-0461D	
5/8" OH #5-1/2	Oval Head	Heavy Gauge Sections	1#	6#	R36-0462D	
15/16" OH #5-1/2	Oval Head	Head Rivet	1/2#	3#	R36-0522D	
1" OH #5-1/2	Oval Head	Head Rivet	1/2#	3#	R36-0465D	
1-1/4" OH #5-1/2	Oval Head	Head Rivet	1/2#	3#	R36-0467D	
1/2" CS #5-1/2	Countersunk	Section Rivet	1#	6#	R36-0464D	
5/8" CS #5-1/2	Countersunk	Section Rivet	1#	6#	R36-0463D	
1" CS #5-1/2	Countersunk	Head Rivet	1/2#	3#	R36-0466D	
1-1/4" CS #5-1/2	Countersunk	Guard Plate Rivet	1/2#	3#	R36-0468D	



R36-0462D

MOWERS DYNA-BALANCE 30, 31, 51 S/N 226040755-EARLIER, 71, 135 FEO SERIES (CAST GEAR BOX)

OEM #	Length	No. Of Sections	Head	Head OEM #	Type	Section	Section OEM #	Riveted Order No	Riveted Price	Bolted Order No	Bolted Price
669791M93	7'	28	Headless	-	XHUSCR	S20-6710	669807M1	S35-3695		-	

MOWERS DYNA-BALANCE 41, 51 S/N 238040755-LATER, 135 (WELDED GEAR BOX)

OEM #	Length	No. Of Sections	Head	Head OEM #	Type	Section	Section OEM #	Riveted Order No	Riveted Price	Bolted Order No	Bolted Price
581177M92	7'	28	H15-0975	581387M1	XHUSCR	S20-6710	669807M1	S35-3887		-	

MOWER CONDITIONERS 725, 925, BADGER NORTHLAND BN1000, BN1005

OEM #	Length	No. Of Sections	Head	Head OEM #	Type	Section	Section OEM #	Riveted Order No	Riveted Price	Bolted Order No	Bolted Price
683583M91	9'	39	Headless	-	XHUSCR	S20-6339	683937M1	S35-3010		-	

MOWER CONDITIONER 81 HAYTENDER

OEM #	Length	No. Of Sections	Head	Head OEM #	Type	Section	Section OEM #	Riveted Order No	Riveted Price	Bolted Order No	Bolted Price
1038699M91	9'	35	Headless	-	XHUS	S20-5107	1036362M1	S35-3620		-	

WINDROWER 35 PULL-TYPE

OEM #	Length	No. Of Sections	Head	Head OEM #	Type	Section	Section OEM #	Riveted Order No	Riveted Price	Bolted Order No	Bolted Price
1042904M91	18'	72	Headless	-	XHTSCR	S20-4969	1046779M1	S35-4048		-	
1041471M91	21'	84	Headless	-	XHTSCR	S20-4969	1046779M1	S35-4049		-	
1041471M91	21'	84	Headless	-	XHTSCR	S20-4968	1046776M1	S35-4741		-	
1050779M91	25'	100	Headless	-	XHTSCR	S20-4969	1046779M1	S35-4928		-	

WINDROWER W/DRAPER HEAD 655, 675, 775, 785, NH 1090, WF 6200

OEM #	Length	No. Of Sections	Head	Head OEM #	Type	Section	Section OEM #	Riveted Order No	Riveted Price	Bolted Order No	Bolted Price
1046769M91H	15'	59	H15-0870	1043844M91	XHTSCR	S20-4398	1046776M1	S35-4737		-	
1043836M91	15'	59	H15-0870	1043844M91	XHUSCR	S20-4398	1041472M1	S35-4876		-	
1046770M91	18'	71	H15-0870	1043844M91	XHTSCR	S20-4398	1046779M1	S35-4058		-	
1043837M91	18'	71	H15-0870	1043844M91	XHUSCR	S20-4398	1041472M1	S35-4877		-	
1046771M91	21'	83	H15-0870	1043844M91	XHTSCR	S20-4398	1046779M1	S35-4059		-	
1043838M91	21'	83	H15-0870	1043844M91	XHUSCR	S20-4398	1041472M1	S35-4878		-	

WINDROWERS 775, 785, 885 USING DRAPER HEADER MAC DON 7000

OEM #	Length	No. Of Sections	Head	Head OEM #	Type	Section	Section OEM #	Riveted Order No	Riveted Price	Bolted Order No	Bolted Price
SS1057967M91	18'	71	Headless	-	XHTTSCR	S20-4398	SS1055090M1	-		S35-2262	
SS1057508M91	21'	83	Headless	-	XHTTSCR	S20-4398	SS1055090M1	-		S35-2253	
	4*	16	Headless	-	XHTTSCR	S20-4398	SS1055090M1	-		S35-2254	
	9*	36	Headless	-	XHTTSCR	S20-4398	SS1055090M1	-		S35-2255	
1057967M91	18'	71	Headless	-	XHTS	S20-3283	1071707M1	-		S35-2023	
1056739M91	25'	99	Headless	-	XHTS	S20-3283	1071707M1	-		S35-2025	
1057912M91	30'	119	Headless	-	XHTS	S20-3283	1071707M1	-		S35-2026	

WINDROWERS 885 USING AUGER HEADER SINGLE DRIVE MAC DON 7000

OEM #	Length	No. Of Sections	Head	Head OEM #	Type	Section	Section OEM #	Riveted Order No	Riveted Price	Bolted Order No	Bolted Price
SS1057934M91	12'	49	Headless	-	XHTSCR	S20-4398	SS1071707M1	-	-	S35-2258	-
1056866M91	14'	57	Headless	-	XHTSCR	S20-4170	1071707M1	-	-	S35-2028	-
SS1056866M91	14'	57	Headless	-	XH7TSCR	S20-4398	SS1071707M1	-	-	S35-2259	-
SSTT1056865M91	14'	59	-	TT1053768M91	XH7TSCR	S20-4418	SSTT1071707M1	-	-	S35-2361	-
1057538M91	16'	65	Headless	-	XHTSCR	S20-4170	1071707M1	-	-	S35-2029	-
SS1057538M91	16'	65	Headless	-	XH7TSCR	S20-4398	SS1071707M1	-	-	S35-2260	-

WINDROWERS 885 USING AUGER HEADER DOUBLE DRIVE MAC DON 7000 & 9000

OEM #	Length	No. Of Sections	Head	Head OEM #	Type	Section	Section OEM #	Riveted Order No	Riveted Price	Bolted Order No	Bolted Price
	7' LH	29	Headless	-	XHTSCR	S20-4170	1071707M1	-	-	S35-2031	-
	7' RH	29	Headless	-	XHTSCR	S20-4170	1071707M1	-	-	S35-2032	-
	7' LH	29	Headless	-	XH7TSCR	S20-4398	SS1071707M1	-	-	S35-2240	-
	7' RH	29	Headless	-	XH7TSCR	S20-4398	SS1071707M1	-	-	S35-2241	-
	8' LH	33	Headless	-	XHTSCR	S20-4170	1071707M1	-	-	S35-2033	-
	8' RH	33	Headless	-	XHTSCR	S20-4170	1071707M1	-	-	S35-2034	-
	8' LH	33	Headless	-	XH7TSCR	S20-4398	SS1071707M1	-	-	S35-2242	-
	8' RH	33	Headless	-	XH7TSCR	S20-4398	SS1071707M1	-	-	S35-2243	-

MOWER CONDITIONERS 34, 36, 44

OEM #	Length	No. Of Sections	Head	Head OEM #	Type	Section	Section OEM #	Riveted Order No	Riveted Price	Bolted Order No	Bolted Price
146469M91	12'	47	H15-0205	144306M91	XHTSCR	S20-4676	146503M2, 160254M1, 261431M1	S35-4373	-	-	-
146470M91	14'	55	H15-0205	144306M91	XHTSCR	S20-4676	146503M2, 160254M1, 261431M1	S35-4374	-	-	-
146471M91	16'	63	H15-0205	144306M91	XHTSCR	S20-4676	146503M2, 160254M1, 261431M1	S35-4375	-	-	-
146253M91	18'	71	H15-0205	144306M91	XHTSCR	S20-4676	146503M2, 160254M1, 261431M1	S35-4205	-	-	-

WINDROWERS 613, 625

OEM #	Length	No. Of Sections	Head	Head OEM #	Type	Section	Section OEM #	Riveted Order No	Riveted Price	Bolted Order No	Bolted Price
1043842M91	21'	83	Headless	-	XHUSCR	S20-6492	1041472M1	S35-4103	-	-	-
1065051M91	25'	99	Headless	-	XHUSCR	S20-6492	1041472M1	S35-4104	-	-	-
1065052M91	30'	119	Headless	-	XHUSCR	S20-6492	1041472M1	S35-4105	-	-	-
SS1069665M91	21'	83	Headless	-	XH7TSCR	S20-4398	SS34390CR	-	-	S35-2253	-
SS1065051M91	4*	16	Headless	-	XH7TSCR	S20-4398	SS34390CR	-	-	S35-2254	-
SS1065052M91	9*	36	Headless	-	XH7TSCR	S20-4398	SS34390CR	-	-	S35-2255	-
SS1069665M91	15*	60	Headless	-	XH7TSCR	S20-4398	SS34390CR	-	-	S35-2256	-

COMBINE 540, 550, 750, 760, 850, 860 USING FLOATING BAR OR WOBBLE DRIVE, 1859 USING FLEX HEADER

OEM #	Length	No. Of Sections	Head	Head OEM #	Type	Section	Section OEM #	Riveted Order No	Riveted Price	Bolted Order No	Bolted Price
SS1053193M92	15'	61	Headless	-	XH7TSCR	S20-4332P	SS1053209M1	S35-4280	-	-	-
SS1053196M92	20'	81	Headless	-	XH7TSCR	S20-4332P	SS1053209M1	S35-4282	-	-	-

COMBINE 410, 510, 540, 550, 750, 850, 760 & 860 W/RIGID 1859 HEAD 2381 & 9000 SERIES & HINIKER

OEM #	Length	No. Of Sections	Head	Head OEM #	Type	Section	Section OEM #	Riveted Order No	Riveted Price	Bolted Order No	Bolted Price
SS260629M94, SS147527M92	20'	80	Headless	-	XH7TSCR	S20-4269	SS146503M3	-	-	S35-2060	-
SS260632M94, SS282344M93	24'	95	Headless	-	XH7TSCR	S20-4269	SS146503M3	-	-	S35-2062	-

SICKLE HEADS AND BUSHINGS

Replaces

Number	Description	Application	Order No.	Price
1043844M91	Sickle Head	Windrowers 655 Hydro & 775, 785 Draper Header	H15-0870	
34388	Sickle Head LH	Windrower 885 Auger Header. Single and Double Drive	H15-0132	
34895	Sickle Head RH	Windrowers	H15-0133	
	Needle Bearing & Seal	Windrowers 885 For H15-0132, H15-0133	B15-0681B	
1041478M91	Head Bushing	Windrowers 655, 775, 785 For H15-0870	B82-0437B	



H15-0870

DISC MOWER KNIVES

OEM Number	Application	Length Inches	Hole Dia. Inches	Style	Shape	Bolt Order No	6 Blades Order No	Price	25 Blades Order No	Price
527749	1306, 1307, 1308, 1309, 1310, 1326, 1327,	4.76	.890"	5	RH Twisted	B55-0355D	B45-6563D		B45-6563	
527748	1328, 1329, 1330, 1339, 1359	4.76	.890"	5	LH Twisted	B55-0355D	B45-6564D		B45-6564	
700712888	1345, 1355, 1365, 1372, 1375, 9070, 9075,	4.21	.717"	4	RH Twisted	B55-0344D	B45-6568D		B45-6568	
700712889	9080, 9175, 9185	4.21	.717"	4	LH Twisted	B55-0344D	B45-6569D		B45-6569	
700711858		4.21	.728	5	RH Twisted	B55-0342D	B45-6560D		B45-6560	
700711857		4.21	.728	5	LH Twisted	B55-0342D	B45-6559D		B45-6559	
DM303	164, 166, 530	3.66	.640"	4	LH Twisted	B55-0358D	B45-6996D		B45-6996	
DM303		3.66	.640"	4	RH Twisted	B55-0358D	B45-6997D		B45-6997	

FORGED GUARDS

Replaces Number	Description	Application	Replaces OEM Number	Order No.	Price
679837M91*	Center-Malleable (Dyna Balance)	Mowers 30, 31, 51, 71,	679837M1	G81-0181	
FS 72-2, BU280	Two Prong	M/C MF 81 Haytender	1036339M1	G81-0065	
FS 81-DH, BU215H	Two Prong (Dbl. Heat Treat)	725 & 925, MF 885 Windrower	683476M1/994M1	G81-0098	
FS 73-2, BU235	Two Prong	Windrowers 655, 35, 675, 775, 785	1041468M1	G81-0070	
FC 62-2A, HA240A	Two Prong	Rigid Combines	228392M2	G81-0191	
FC 89-2, HA231	Two Prong (w/Groove)	Comb. 760, 750, 550, 540, 1859 Flex (HC)		G81-0125	



ADJUSTABLE HOLD DOWN CLIPS

Replaces	Type	Description	Application	Order No	Price
XL2000ADJ	Cast	Clip (Lo-Arch)	All Mowers, Conditioners & Swathers	C45-0006	
XH2000ADJ	Cast	Clip (Hi-Arch)		C45-0007	
XLA	Cast	Clip Only, Low		C45-0008	
RB100	N/A	Rubber Elastomer	Most Combines, Mowers, & Windrowers, Except Versatile, Hart-Carter, & Love	R36-0001	
L600ADJ	Steel	Lo-Arch, Adjustable		C45-0040	

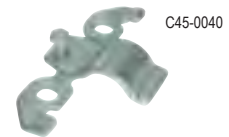

GUARD BOLTS FOR MOWERS AND CONDITIONERS

For cutter bars 7' or smaller.

Size/No. in Pkg.	Description	Order No.	Price
7/16"x 1-3/8" (12)	Universal No. 3 Head Bolt	B55-0700	
7/16"x 1-11/16" (18)	Universal No. 3 Head Bolt		
Z1005H (30)	Conical Nuts		
7/16" (5)	Conical Nut for Guards	N83-0593D	

6" WEAR PLATE

For all mowers and combines.

Replaces Number	Order No.	Price
206196M1	P44-0472	

BALE COUNTER

Bale counter, reads up to 99,999. 4 hole mounting plate, push button reset, adjustable side arm. Fits most balers.



Order No.	Price
T55-0002	

GRASS BOARD

Fits all mowers



Order No.	Price
B52-0615	

PITMAN WOOD

Universal

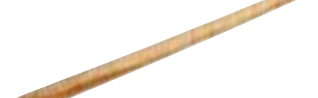

Order No.	Price
P38-0560	

RAKE / BALER / COMBINE TEETH

Replaces Number	Description	Application	Pkg. Qty.	Order No.	Price
667656M1	1 Prong Tooth, Spring	All Rakes to 1958, model 20 to (S/N)14449	100	T16-0367	
1053394M91	2 Prong Tooth, Spring	Round Balers, 1440, 1560	100	T16-0485	
4000-997	2 Prong Tooth, Spring	1440 (Rubber Mounted)	50	T16-0488	
HE1017004	2 Prong, Plastic Flex Tooth	Combine Pick-Up Tooth	500	T16-0050	
RMT-1	1 Prong Rubber Mt.	Rakes 640, 650, 660, 670, 671	100	T16-0182	
667530M0, 668364M1, DE03435A	1-Prong Tooth, Spring	Most All Rakes Including MH21, 25 (S/N 14450-), 36, 37	100	T16-0335	



FLEXIBLE REEL AND BAT TINES

Replaces Number	Application	Pkg. Qty.	Order No.	Price
782551, 1989438C1, AH136689, AH153175	2 pc. M/L Reel Tine w/clamps	100	T16-0720	
782226, 1989438C1, AH136689, AH153175	2 pc. M/L Reel Tine w/clamps	10/Bag	T16-0715	
HA100MLT	M/L Reel Tine Only, Less Clamps; For T16-0720 & T16-0715	100/Box	T16-0725	
HA20SC	Replacement Screw for T16-0720, T16-0715	20/BB	B55-0096D	



HERSCHEL 6" 2-PIECE POLY TINES FOR PIPE REELS



- PATENTED 2 PIECE DESIGN.
- SAVE MONEY! REPLACE ONLY THE TINE.

Description	Pkg. Qty.	Order No.	Price
Tine & Clamp	100/Box	T16-0740	
Tine & Clamp	10/Box	T16-0745	
Tine ONLY	100/Box	T16-0750	

**24-HOUR SHOPPING AT
HERSCHELPARTS.COM**

POLY SKID SHOE KITS - WHITE

- 1/4" ultra high molecular Polyethylene material is super slick and lightweight.
- The abrasion resistance of this plastic is 1.8 times greater than steel.
- Has nearly the exact same "sliding" properties as Teflon.
- Prevents losing valuable harvest days due to wet weather.
- Allows you to harvest in wet conditions or clay with no sticky build-up.
- Easy to install. Drill holes in steel plates & fasten with the furnished hammer rivets.
- Precut and formed. All Plates come with countersunk drilled holes.
- Protects your metal skid shoes so they never wear out.

Sickle Size	Application	Order No.	Price	Sickle Size	Application	Order No.	Price
15', 16'	MF 1859 & MF 9100	P44-1090		20'	MF 9300, 9500, 9750	P44-9320	
18'	MF 1859 & MF 9100	P44-1091		22'	MF 9300, 9500, 9750	P44-9322	
20'	MF 1859 & MF 9100	P44-1092		24'	MF 9300, 9500, 9750	P44-9324	
15'	MF 9300, 9500, 9750	P44-9315		25'	MF 9300, 9500, 9750	P44-9325	
16'	MF 9300, 9500, 9750	P44-9316		30'	MF 9300, 9500, 9750	P44-9330	
18'	MF 9300, 9500, 9750	P44-9318					

POLY REPLACEMENT PARTS FOR HERSCHEL SPECKLED POLY KITS

Fits Massey Ferguson 1859 & 9100 Flexhead

Replaces Number	Size Length x Width	Rivets Required	Qty. Required	Order No.	Price
HC3-18	7"x18"	8	3 4 4 5 6 8	P44-1121	
HC3-33	7"x33"	12	1 1 1 1 1 1	P44-1122	
HC3-44	7"x44"	16	1 1 1 1 1 1	P44-1123	

PLASTIC BEARINGS & HARDWARE FOR PIPE REEL KITS

Description	Order No.	Price
Outside Tine Bracket. Use with T16-0730 to replace LH or RH original steel reel end fingers. Fits Herschel-Adams Reel Conversion Kits. Sold individually.	B65-0120	
Plastic Bearing Kit. Includes 6 bases, 6 caps, 6 U-bolts, & 12 nuts. Fits reels with wood bats used on JD Quick-Tach & 200 series. Also fits reels with Tear Drop Bats used on JD 900 series prior to S/N 645300. Sold 6/box.	B15-0915	
Plastic Bearing Kit. Includes 12 bearing halves, 12 bolts, & 12 nuts. Fits reels with Tear Drop Bats & Rear Mounted Plastic Tines used on MF 9700 & 9750 series. Sold 6/box.	B15-0920	
Plastic Bearing Kit. Includes 12 bearing halves, 6 bolts & 6 nuts. Fits MF 9700, 9750. Pipe Reels. Sold 6/Box.	B15-0925	

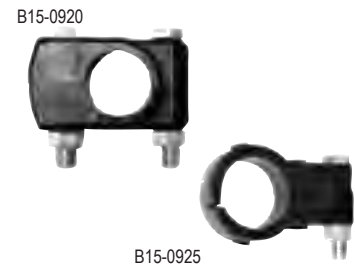

HAMMER RIVETS AND TOOL

Replaces Number	Size	Description	Application	Pkg. Qty.	Order No.	Price
SPK9	3/16" x 5/16"	Large Head Rivet	MF 1859 Flexhead	50/BB	R36-0655	
		Hammer Rivet Tool for Drive Rivets			T55-0812	



GATHERING CHAINS

Combine head application: 22, 222, 321, 322, 33, 421, 422, 43, 63, 621, 1143, 1153, 1163, 1183

Replaces Number	Replaces OEM No.	Chain Type & Quantity	Att.Lk. Type & Qty.	Offset Links	Conn. Links	Total Links	Wt. Each	Order No.	Price
12-0002	241090M91	CA2060H(55)	C6E(8)	None	1	64	9-1/4 #	C30-0145	



STRAW CHOPPER KNIFE KITS

Replaces Number	Set Includes	Order No.	Price
SCKK-100	3 Knives	C83-0601	
837030M93	3 Bushings		
	3 Lock Nuts		
	3 Bolts		

GATHERING CHAIN IDLER SPROCKETS

Replaces OEM Number	Model Application	Order No.	Price
263282M1	All Q.A. Heads except 1100 Series	S62-0742	
844076M1	1100 Series	S62-0743	



A	
Auger Fingers.....	60
B	
Bale Counter.....	59
Baler Teeth.....	59
Board, Grass.....	58
Bolt-N-Clip Kit.....	52
Bolts, Section.....	52
C	
Cover Plates, Poly.....	59
D	
Disc Mower Knives.....	57
E	
End Sections.....	52
G	
Grass Board.....	58
Guard Bolt Kit.....	58
Guards.....	58
H	
Hammer Rivet Tool.....	60
Hammer Rivets.....	60
Hold Down Clips.....	58
I	
Idler Pulleys.....	60
K	
Kit, Guard Bolt.....	58
Kits, Overlap Section.....	51
Kits, Poly Skid Shoe.....	60
O	
Overlap Sections.....	51
Overlap Section Kits.....	51
P	
Pitman Wood.....	58
Poly Cover Plates.....	59
Poly Replacement Parts.....	59
Poly Skid Shoe Kits.....	60
Pulleys, Idler.....	60
R	
Rake Teeth.....	59
Rake Wheels.....	59
Reel Teeth.....	59
Rivets, Hammer.....	60
Rivets, Section.....	52

S	
Sections.....	51 - 52
Section Bolts.....	52
Section Rivets.....	52
Sickle Heads.....	56
Sickles.....	53 - 56
Sickles, Versatile.....	57
Spliced Sickles.....	56
Straw Chopper Knife Set.....	59
T	
Teeth, Baler.....	59
Teeth, Rake.....	59
Teeth, Reel.....	59
V	
Versatile Sections.....	51
Versatile Sickles.....	57
W	
Wear Plates.....	58

SECTION TYPE ABBREVIATIONS

Section Finish	Section Type	Section Thickness
CR = Chrome	7TS = Super 7 Top Serrated SM = Smooth US = Under Serrated TS = Top Serrated TT = Tiger Tooth TJ = Tiger Jaw SRK = Tiger Shark	XH = Extra Heavy .116"

Replaces Number	Size	Description	Application	Rivet Used	Section Letter	Pkg. Qty.	Order No.	Price
26622	3" x 3-1/4"	XHSM	NH Mowers & Conditioners	5/8 OH		10	S20-1145	
29875	3" x 3-1/4"	XHUS	NH Mowers & Conditioners	5/8 OH B-		10	S20-5107	
706226	3" x 3-1/4"	XHUSCR	NH Mowers & Conditioners	5/8 OH B-		10	S20-6339	
67630	3" x 3-1/4"	XHUS	NH Mowers & Conditioners	1/2 OH B-		10	S20-5244	
67631	3" x 3-1/4"	XHTS	NH Mowers & Conditioners	1/2 OH B		10	S20-3412	
604800	3" x 3-1/4"	XHUSCR	NH Mowers & Conditioners	1/2 OH B-		10	S20-6332	
276617CR	3" x 3-1/4"	XHUSCR	NH 109 Pull-Type Windr. 1090 Windr.	1/2 OH C-		10	S20-6492	
275522	3" x 3-1/4"	XHTSCR	NH 109 Pull-Type Windr. 1090 Windr.	1/2 OH C		10	S20-4969	
694723	3" x 3-1/4"	XHTSCR	NH TR Series Combine, 970, 971, 972, 973	5/8 OH P		10	S20-4790	
134104	3" x 3-1/4"	XHTSCR	NH Combines w/Rigid Headers	5/8 OH N		10	S20-4719	
271981 CR	3" x 3"	XHTSCR	NH Combines w/Love Floating Headers	5/8 CS		10	S20-4608	
TT29875	3" x 3-1/4"	XHTTCR	Mowers, Mower Cond. w/Tiger Tooth Sickles	TJ55BN R		10	S20-4464	
TJ7000	3" x 3-1/4"	XHTTCR	Combines w/ Tiger Jaws	TJ55BN R		10	S20-4639	
TJ7000	3" x 3-1/4"	XHTTCR	Combines w/ Tiger Jaws	TJ55BN R+		10	S20-4317	
9622744, 826720C3, 86615988	3" x 3-1/4"	XHTS	NH Mowers & Conditioners and 71C, 72C, 73C, 74C Grain Heads	5/8 OH B		10	S20-3276	
9622744, 112074A1	3" x 3-1/4"	XH7TS		5/8 OH B+		10	S20-3325	
596321R4, 86616689	3" x 3-1/4"	XH7TSCR		5/8 OH B+		10	S20-4268	
700705300, 86616527	3" x 3-1/4"	XHTSCR		5/8 OH B		10	S20-4277	
	3" x 3-1/4"	Tiger Shark™	Used To Replace OEM Numbers Listed Below	TJ55BN		10	S20-8398	
87422066CR	3" x 3-1/4"	XH7TSCR	82C, 83C, 84C 86C Headers	TJ55BN R+		10	S20-4398	
1327448C1	3" x 3-1/4"	XHTS		TJ55BN		10	S20-3283	
137448C1CR	3" x 3-1/4"	XHTTCR		TJ55BN		10	S20-4170	
	3x3-1/4	Tiger Shark™	Used To Replace OEM Numbers Listed Below			10	S20-8549	
8728905	3x3-1/4	XH7TS	3020, 3162, 3152, NH740CH, NH880CF	B+		10	S20-3549	



FORD SECTIONS

Replaces Number	Size	Section Description	Application	Letter	Pkg. Qty.	Order No.	Price
141198	3" x 3-1/4"	XHUS	Mowers	A-	10	S20-5246	
141198 CR	3" x 3-1/4"	XHUSCR	Mowers	A-	10	S20-6344	
141113	3" x 3-1/4"	XHUS	Mowers	A-	10	S20-5110	
141197	3" x 3-1/4"	XHSM	Mowers		10	S20-1142	
M333-1/2	3" x 3-1/4"	XHSM	Mowers, Mower/Conditioner		10	S20-4445	
141197CR	3" x 3-1/4"	XHSMCR	Mowers, Mower/Conditioner		10	S20-2758	
	3" x 3-1/4"	XH7TS	Mowers, Windrowers, Swathers	A+	10	S20-3407	

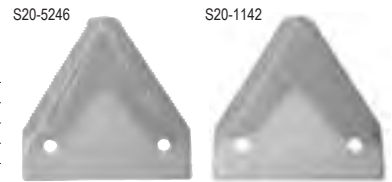

VERSATILE SECTIONS

2-1/16" Hole Spacing

Replaces Number	Size	Description	Application	Rivet/Bolt Used	Letter Code	Pkg Qty.	Order No.	Price
SW 1616 CR	3" x 3"	R TS CR (w/Low Shoulder)	Versatile-Wind. 10, 103, 400, 4400	1/2 CS	D	10	S20-4448	
SW 1616	3" x 3"	R TS (w/Low Shoulder)		1/2 CS	D	10	S20-3199	
SW 1776	3" x 3"	R TS (w/Hi Shoulder)		1/2 CS	E	10	S20-3203	
SW 1776 CR	3" x 3"	R TS CR (w/Hi Shoulder)		1/2 CS	E	10	S20-4450	
SSW1776	3" x 3"	R7TS (w/Hi Shoulder)		1/2 CS	E+	10	S20-3287	
SSW1616	3" x 3"	R7TS (w/Low Shoulder)		1/2 CS	D+	10	S20-3288	
VS 1616 BN	3" x 3"	H TS for Bolts (w/Low Shoulder)		B55-0065D	D	10	S20-3975	
SSVS1616BN	3" x 3"	H7TS (w/Low Shoulder)		B55-0065D	D+	10	S20-3425	



SECTIONS - OVERLAP

Replaces Number	Size	Description	Application	Rivet Used	Pkg. Qty.	Order No.	Price
706421	3" x 3 1/4"	XHUSCR	Windrowers 907, 909, 910, 912, 1100, 1112	(Btm. C.S.)	10	S20-6767	
706422	3" x 3 1/4"	XHUSCR	Windrowers 907, 909, 910, 912, 1100, 1112	(Top C.S.)	10	S20-6768	
706424	3" x 3 1/4"	XHTSCR	Hay Machines	(Btm. C.S.)	10	S20-4883	
706423	3" x 3 1/4"	XHUSCR	Hay Machines	(Top C.S.)	10	S20-4882	
694721	3" x 3 1/4"	XHTSCR	Combines w/Rigid Header	(Top C.S.)	10	S20-4721	
694722	3" x 3 1/4"	XHTSCR	Combines w/Rigid Header	(Btm. C.S.)	10	S20-4722	
635161	3" x 3 1/4"	XHUS	499 & 1499 Mower Conditioner	(Btm. C.S.)	10	S20-5126	
635162	3" x 3 1/4"	XHUS	499 & 1499 Mower Conditioner	(Top C.S.)	10	S20-5127	
SS635162	3" x 3 1/4"	XH7TSCR	All Double Drive Sickles	(Top C.S.)	10	S20-4308	
SS635161	3" x 3 1/4"	XH7TSCR	All Double Drive Sickles	(Btm. C.S.)	10	S20-4309	
635161	3" x 3 1/4"	XHTSCR	1112-1118	(Btm. C.S.)	10	S20-4371	
635162	3" x 3 1/4"	XHTSCR	1112-1118	(Top C.S.)	10	S20-4370	
N/A			HTSC Overlap 900, 1100 Series, 2450, 2550			S20-4005	

Section Kit Contains (2) S20-4308 Countersunk, (4) S20-4309 Countersunk Sections, (1) Wear Strip, (6) 5/8" CS Bolts, (6) 1/2" CS Bolts & Nuts

UNIVERSAL END SECTIONS

HERSCHEL "End Sections" are made of heat-treated steel for rugged use. They are punched with an oblong hole to virtually fit any standard cutterbar mower in use today. To install our "End Section", simply take off the last section on the shoe end of your sickle assembly and replace it with an "End Section". The change-over takes only a couple of minutes to complete and you will notice a big difference in time saved from unclogging your mower. We recommend using R36-0523D head rivet or B55-0065D Bolt.

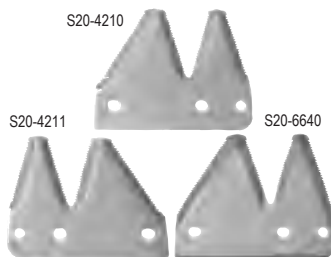

For all mowers, mower conditioners and windrowers with standard cutterbar.

Description	Order No.	Price	Description	Order No.	Price
XH7TSCR (RH) 10/Box	S20-4403		XHTS CR (RH) 2/SP	S20-4210D	
XH7TSCR (RH) 2/SP	S20-4403D		XHTSCR (LH) 10/Box	S20-4211	
XH7TSCR (LH) 10/Box	S20-4445		XHTSCR (LH) 2/SP	S20-4211D	
XH7TSCR (LH) 2/SP	S20-4445D		XHUSCR (RH) 10/Box	S20-6640	
XHTS CR (RH) 10/Box	S20-4210		XHUSCR (RH) 2/SP	S20-6640D	

SECTION - TIGER TOOTH / TIGER JAWS

3" x 3-1/4". 10 Per package.

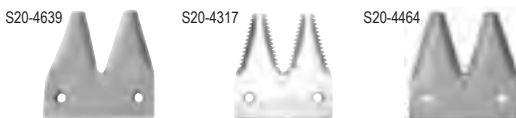

Replaces

Number	Description	Application	Order No.	Price
TJ7000	XHTTCR	Combines w/ Tiger Jaws	S20-4639	
SSTJ7000	XH7TSCR		S20-4317	
TT29875	XHTTCR	Mowers, Mowers Cond. & Windrowers	S20-4464	

NEW HOLLAND

SECTION BOLTS

- Quick and easy section changes are possible with bolts.
- No more cutting, chiseling, or grinding - simply unbolt the section, replace and tighten bolts.
- Bolts will not turn in Knife Back and are reusable. They will last thru the life of several sections.
- Bolts may be replaced easily if accidentally damaged or broken.
- No special tools are needed to change sections, only a 7/16" wrench or socket.
- Bolt and nuts hold better than rivets and they have a greater "clamp load" than rivets.
- Special lock nuts will not vibrate loose.

Description	Application	Qty. Pkg.	Qty. Mstr.	Order No.	Price
Section Bolt w/nut	Universal - Replaces 9/16" & 5/8" OH Rivets	50	300	B55-0065D	
Head Bolt w/nut	Universal - Replaces 1-1/2" & 1-1/16" OH Rivets	15	90	B55-0085D	
Head Bolt w/nut	Universal - 1-1/2" OH Rivets	12	72	B55-0095D	
Section Bolt w/nut	Universal - Bolts for 10' Sickle w/head Bolts Include (80) B55-0065, (5) B55-0085, (5) B55-0095	90	Each	B55-0500D	
Nut	Universal - Used On All Above Bolts	20	120	N83-0289D	
Conical Guard Bolt Nut	For 7/16" Bolt	5	30	N83-0593D	
Low Profile Nut	Double Drive Sickles for Overlap Bolts	20	120	N83-0295D	
5/8" Bolt & Nut, Oval Shoulder, For Sections	Versatile - Windrower 4400, 2400, 2800	20	120	B55-0955D	
7/8" Bolt & Nut, Oval Shoulder, For Heads	Versatile - Windrower 4400, 2400, 2800	10	60	B55-0975D	
Overlap Bolt w/low profile nut 1/2" CS	Double Drive Sickles (use with Allen Wrench)	10	60	B55-0059D	
9/16" CS Section Bolt & Nut	Countersunk Bolt. 60°	20	120	B55-0056D	
5/8" Section Bolt & Nut	Countersunk Bolt. 60°	20	120	B55-0057D	
1" CS Head Bolt & Nut	Versatile - Head Bolt	10	60	B55-0058D	
1" CS Ribbed Bolt & Nut	Versatile Bolted Sickles	25	150	B55-0971D	
5/8" CS Ribbed Bolt & Nut	Versatile Bolted Sickles	50	300	B55-0970D	



RIVETS

Size/No. in Pkg.	Description	Application	Qty. Pkg.	Mstr. Ctn.	Order No.	Price
5/8" # 5-1/2 (56)	OH Rivets Asst.	7' Heavy Mower Sections and Knife Heads	Asst.	6	R36-0523D	
1" # 5-1/2 (10)	Zinc Pltd.					
5/8" # 5-1/2 (72)	OH Rivets Asst.	Mower Conditioners	Asst.	6	R36-0524D	
1" # 5-1/2 (5)	Zinc Pltd.					
1-1/4" # 5-1/2 (5)						
1/4" # 5/8 OH	OH Rivets Zinc Plt.	Heavy Gauge Sections	1#	6#	R36-0480D	
1/2" OH #5-1/2	OH Rivets Zinc Plt.	Regular Gauge Sections	1#	6#	R36-0521D	
9/16" OH #5-1/2	OH Rivets Zinc Plt.	Heavy Gauge Sections	1#	6#	R36-0461D	
5/8" OH #5-1/2	OH Rivets Zinc Plt.	Heavy Gauge Sections	1#	6#	R36-0462D	
15/16" OH #5-1/2	OH Rivets Zinc Plt.	Head Rivet	1/2#	3#	R36-0522D	
1" OH #5-1/2	OH Rivets Zinc Plt.	Head Rivet	1/2#	3#	R36-0465D	
1-1/4" OH #5-1/2	OH Rivets Zinc Plt.	Head Rivet	1/2#	3#	R36-0467D	
1/2" CS #5-1/2	CS Rivets Zinc Plt.	Section Rivet	1#	6#	R36-0464D	
5/8" CS #5-1/2	CS Rivets Zinc Plt.	Section Rivet	1#	6#	R36-0463D	
1" CS #5-1/2	CS Rivets Zinc Plt.	Head Rivet	1/2#	3#	R36-0466D	
1-1/4" CS #5-1/2	CS Rivets Zinc Plt.	Guard Plate Rivet	1/2#	3#	R36-0468D	



BOLT-N-CLIP KIT

Bolts are Better Than Rivets

- Bolts will not turn in Knife Back and are reusable. • They will last thru the life of several sections.
- Bolts may be replaced easily if accidentally damaged or broken.
- No special tools are needed to change sections, only a 7/16" wrench or socket.
- Bolts and nuts hold better than rivets and they have a greater "clamp load" than rivets.

Size	Description	Application	Order No.	Price
10' Bar	Special Hi-Clearance Hold Down Clips, Over the head Clip, Section Bolts and Lock Nuts	Most Mowers, M/C & Combines up to 10'	B55-0629	



FORD MOWERS 515 SERIES

OEM #	Length	No. Of Sections	Head	Head OEM #	Type	Section	Section OEM #	Riveted Order No	Riveted Price	Bolted Order No	Bolted Price
241905	7'	(29)		242063	XHUS		141198	S35-3367		-	
241906	8'	(33)		242063	XHUS		141198	S35-3371		-	

FORD MOWERS 175, 176, 257, 258, 259, 260, 501 SERIES, 14-94, 95, 96, 97

OEM #	Length	No. Of Sections	Head	Head OEM #	Type	Section	Section OEM #	Riveted Order No	Riveted Price	Bolted Order No	Bolted Price
240890	7'	(28)		147874	XHSM		141197	S35-3658		-	
148119	7'	(28)		147874	XHUS		141113	S35-3654		-	
240891	7'	(28)		147874	XHUS		141198	S35-3659		-	

FORD MOWERS 505 SERIES AND 538

OEM #	Length	No. Of Sections	Head	Head OEM #	Type	Section	Section OEM #	Riveted Order No	Riveted Price	Bolted Order No	Bolted Price
462381R9	7'	(28)		56692C91	XHSM		26622	S35-3668		-	
462380R9	7'	(28)		56692C91	XHUS		29875	S35-3667		-	
463182R9	9'	(36)		56692C91	XHSM		26622	S35-3672		-	
463159R9	9'	(36)		56692C91	XHUS		29875	S35-3669		-	

FORD MOWERS 535

OEM #	Length	No. Of Sections	Head	Head OEM #	Type	Section	Section OEM #	Riveted Order No	Riveted Price	Bolted Order No	Bolted Price
290627S	9'	(35)	Less Head	-	XHUS		OU577HS	S35-3620		-	

FORD MOWERS 536 AND 537

OEM #	Length	No. Of Sections	Head	Head OEM #	Type	Section	Section OEM #	Riveted Order No	Riveted Price	Bolted Order No	Bolted Price
340-32056	9'	(35)	Less Head	-	XHUS		OU577HS	S35-3681		-	

FORD MOWER/CONDITIONER 538

OEM #	Length	No. Of Sections	Head	Head OEM #	Type	Section	Section OEM #	Riveted Order No	Riveted Price	Bolted Order No	Bolted Price
101988C91	9'	(37)		824594C91	XHUS		29875	S35-3292		-	

NEW HOLLAND MOWERS 44, 45, 46, 47

OEM #	Length	No. Of Sections	Head	Head OEM #	Type	Section	Section OEM #	Riveted Order No	Riveted Price	Bolted Order No	Bolted Price
MA22837	7'	(28)		MA999	XHUS		826722C1	S35-3630		-	

NEW HOLLAND MOWER PITMANLESS MODEL 450 PRIOR TO S/N 87765 AND 455 PRIOR TO S/N 88846

OEM #	Length	No. Of Sections	Head	Head OEM #	Type	Section	Section OEM #	Riveted Order No	Riveted Price	Bolted Order No	Bolted Price
64636	7'	(28)		64693	XHUS		29875	S35-3975		-	

NEW HOLLAND MOWER 450 AFTER S/N 87764 AND 455 AFTER S/N 88846 451 WITH SINGLE GUARDS

OEM #	Length	No. Of Sections	Head	Head OEM #	Type	Section	Section OEM #	Riveted Order No	Riveted Price	Bolted Order No	Bolted Price
143607	7'	(28)		858740	XHUS		29875	S35-3389		-	
143609	9'	(36)		858740	XHUS		29875	S35-3390		-	
143609	9'	(36)		858740	XHTS		29875	S35-3342		-	

NEW HOLLAND MOWERS 451 AND 456 WITH DOUBLE GUARDS

OEM #	Length	No. Of Sections	Head	Head OEM #	Type	Section	Section OEM #	Riveted Order No	Riveted Price	Bolted Order No	Bolted Price
SS228435	7'	(29)		858740	XH7TS		SS9622744	-		S35-1024	
SS858744	7'	(29)		858740	XH7TSCR		SS604921H	-		S35-2289	
TT228435	7'	(29)		TT143603	XHTTCR		9622744	-		S35-2566	
SST228435	7'	(29)		TT143603	XH7TTCR		SSTJ7000	-		S35-2362	
5228435	7'	(29)		143603	XHUS		29875	S35-3884		-	
858745	9'	(35)		858740	XHUS		29875	-		S35-2558	S35-1704
					Tiger Shark™						
					Tiger Shark™					S35-2552	
SS858745	9'	(35)		858740	XH7TSCR		SS29875	-		S35-2128	
228434	9'	(35)		858740	XH7TS		29875	S35-3006		-	
228434	9'	(35)		143603	XHUS		29875	S35-3885		-	

NEW HOLLAND MOWER CONDITIONER 460 AND 461

OEM #	Length	No. Of Sections	Head	Head OEM #	Type	Section	Section OEM #	Riveted Order No	Riveted Price	Bolted Order No	Bolted Price
134186	9'	(35)		86507377	XHUS		29875	S35-3282		-	

NEW HOLLAND MOWER CONDITIONER 467

OEM #	Length	No. Of Sections	Head	Head OEM #	Type	Section	Section OEM #	Riveted Order No	Riveted Price	Bolted Order No	Bolted Price
137214	7'	(29)		86507377	XHUS		29875	S35-3057		-	

NEW HOLLAND MOWER CONDITIONER 469, 1469

OEM #	Length	No. Of Sections	Head	Head OEM #	Type	Section	Section OEM #	Riveted Order No	Riveted Price	Bolted Order No	Bolted Price
648844	9'	(37)	-	86507377	XHUS	-	29875	S35-3055	-	S35-1705	-
SS86518678	9'	(37)	-	86507377	XH7TS	-	SS9622744	-	-	S35-3164	-
SSTT86518678	9'	(37)	-	TT86507377	XH7TTCR	-	SSTJ7000	-	-	S35-2053	-

NEW HOLLAND MOWER CONDITIONER MODEL 495 AND 1495

OEM #	Length	No. Of Sections	Head	Head OEM #	Type	Section	Section OEM #	Riveted Order No	Riveted Price	Bolted Order No	Bolted Price
648003	12'	(49)	-	86508155	XHUS	-	29875	S35-3128	-	-	-
858706	12'	(49)	-	86508155	XHUS	-	29875	-	-	S35-1708	-
SS9623572	12'	(49)	-	86508155	XH7TS	-	SS9622744	-	-	S35-1001	-
SSTT648003	12'	(49)	-	TT86508155	XH7TTCR	-	SSTJ7000	-	-	S35-2371	-

NEW HOLLAND MODEL 472, 477, 478

OEM #	Length	No. Of Sections	Head	Head OEM #	Type	Section	Section OEM #	Riveted Order No	Riveted Price	Bolted Order No	Bolted Price
648832	7'	(29)	-	577868	XHUS	-	29875	S35-3864	-	-	-
858708	7'	(29)	-	577868	XHUS	-	29875	-	-	S35-1280	-

NEW HOLLAND MOWER CONDITIONER 479, 488, 1469 AFTER S/N 220947

OEM #	Length	No. Of Sections	Head	Head OEM #	Type	Section	Section OEM #	Riveted Order No	Riveted Price	Bolted Order No	Bolted Price
648840	9'	(37)	-	577867	XHUS	-	29875	S35-3865	-	-	-
858700	9'	(37)	-	577867	XHUS Tiger Shark™	-	29875	-	-	S35-2560	-
SS9623570	9'	(37)	-	577867	XH7TS	-	SS9622744	-	-	S35-1706	-
SSTT648840	9'	(37)	-	TT577867	XH7TSCR	-	SSTJ7000	-	-	S35-3165	-
										S35-2052	-

NEW HOLLAND MOWER CONDITIONER 490 (S/N 259715 AND UP)

OEM #	Length	No. Of Sections	Head	Head OEM #	Type	Section	Section OEM #	Riveted Order No	Riveted Price	Bolted Order No	Bolted Price
579171	12'	(49)	-	86512652	XHUS	-	29875	S35-3076	-	-	-

NEW HOLLAND MOWER CONDITIONER 474, 489, 492 AND 1465

OEM #	Length	No. Of Sections	Head	Head OEM #	Type	Section	Section OEM #	Riveted Order No	Riveted Price	Bolted Order No	Bolted Price
648831	7'	(29)	-	289488	XHUS	-	29875	S35-3375	-	-	-
858702	9'	(37)	-	289488CS	XHUS	-	29875	-	-	S35-1707	-
SS86529232	9'	(37)	-	289488CS	SSTS Tiger Shark™	S20-8268	SS9622744	-	-	S35-3166	-
SSTT648835	9'	(37)	-	TT289488CS	XH7TTCR	-	SSTJ7000	-	-	S35-2561	-
648835	X9'	(37)	-	289488	XHUS	-	29875	S35-3283	-	-	-

NEW HOLLAND MOWER CONDITIONER 499, 1496, WINDROWER 1499

OEM #	Length	No. Of Sections	Head	Head OEM #	Type	Section	Section OEM #	Riveted Order No	Riveted Price	Bolted Order No	Bolted Price
635163	6' LH	(24)	-	86536346	XHUS	-	29875	S35-3798	-	-	-
9619698	6' LH	(24)	-	86536346	XHUS	-	29875	-	-	S35-1128	-
635279	6' RH	(25)	-	86536345	XHUS	-	29875	S35-3799	-	-	-
9619699	6' RH	(25)	-	86536345	XHUS	-	29875	-	-	S35-1129	-
SS9622712	6' LH	(24 or 25)	-	86536346	XH7TS	-	SS9622744	-	-	S35-1006	-
SS9622713	6' RH	(25)	-	86536345	XH7TS	-	SS9622744	-	-	S35-1007	-

*Sickle comes with 25 sections. Count sections on old sickle and take 1 off at head end if need 24.

NEW HOLLAND MODEL 109 PULL TYPE

OEM #	Length	No. Of Sections	Head	Head OEM #	Type	Section	Section OEM #	Riveted Order No	Riveted Price	Bolted Order No	Bolted Price
276614 CR	18'	(72)	-	Less Head	XHTSCR	-	275522	S35-4048	-	-	-
276625 CR	21'	(87)	-	Less Head	XHTSCR	-	275522	S35-4049	-	-	-
276639 CR	25'	(100)	-	Less Head	XHTSCR	-	275522	S35-4928	-	-	-

NEW HOLLAND WINDROWER 907, 909, 910, 912

OEM #	Length	No. Of Sections	Head	Head OEM #	Type	Section	Section OEM #	Riveted Order No	Riveted Price	Bolted Order No	Bolted Price
139179	6' LH	(25)	-	137635	XHUSCR	-	604800	S35-4394	-	-	-
139179	6' RH	(25)	-	137635	XHUSCR	-	604800	S35-4395	-	-	-
139185	7' LH	(28)	-	135822	XHUSCR	-	604800	S35-4396	-	-	-
139184	7' RH	(29)	-	137635	XHUSCR	-	604800	S35-4397	-	-	-

NEW HOLLAND WINDROWER 1090 SELF PROPELLED

OEM #	Length	No. Of Sections	Head	Head OEM #	Type	Section	Section OEM #	Riveted Order No	Riveted Price	Bolted Order No	Bolted Price
275503	15'	(59)	-	275506	XHTSCR	-	275521	S35-4737	-	-	-
275504	18'	(71)	-	275506	XHTSCR	-	275522	S35-4058	-	-	-
275505	21'	(83)	-	275506	XHTSCR	-	275522	S35-4059	-	-	-

NEW HOLLAND WINDROWER 1100 HIGH PERFORMANCE HEADER 1112,1114,1116,1118,116 (14' & 16')

OEM #	Length	No. Of Sections	Head	Head OEM #	Type	Section	Section OEM #	Riveted Order No	Riveted Price	Bolted Order No	Bolted Price
SSTT247987	7' LH	(28)		247989	XH7TTCR		SSTJ7000	-		S35-2363	
SSTT247988	7' RH	(29)		247970	XH7TTCR		SSTJ7000	-		S35-2364	
247987	7' LH	(28)		247989	XHUSCR		604800	S35-4029		-	
					<i>Tiger Shark™</i>					<i>S35-2521</i>	
9619696	7' LH	(28)		247989	XHUSCR		604800	-		S35-2702	
247988	7' RH	(29)		247990	XHUSCR		604800	S35-4033		-	
					<i>Tiger Shark™</i>					<i>S35-2523</i>	
9619697	7' RH	(29)		247990	XHUSCR		604800	-		S35-2700	
TS247987	7' LH	(28)		247989	XHTSCR		604921	S35-4037		-	
TS247988	7' RH	(29)		247990	XHTSCR		604921	S35-4040		-	
XH7TS247987	7' LH	(28)		247989	XHSTSCRS		604921H	-		S35-2005	
XH7TS247988	7' RH	(29)		247990	XHSTSCRS		604921H	-		S35-2006	
858724	7' LH	(28)		247990	XHTSCR		604921H	-		S35-2755	
858725	7' RH	(29)		247989	XHTSCR		604921H	-		S35-2756	
SSTT264987	8' LH	(32)		247990	XH7TTCR		SSTJ7000	-		S35-2365	
SSTT264985	8' RH	(33)		247989	XH7TTCR		SSTJ7000	-		S35-2366	
264987	8' LH	(32)		247990	XHUSCR		604800	S35-4030		-	
9619694	8' LH	(32)		247989	XHUSCR		604800	-		S35-2703	
264985	8' RH	(33)		247989	XHUSCR		604800	S35-4034		-	
9619695	8' RH	(33)		247990	XHUSCR		604800	-		S35-2701	
TS264987	8' LH	(32)		247989	XHTSCR		604921	S35-4036		-	
TS264985	8' RH	(33)		247990	XHTSCR		604921	S35-4041		-	
858722	8' LH	(32)		247989	XHTSCR		604921H	-		S35-2758	
858723	8' RH	(33)		247990	XHTSCR		604921H	-		S35-2759	

NEW HOLLAND WINDROWER 907, 909, 910, 912, 1112, 1114, 1116, 1118, 116, 114, 1100

OEM #	Length	No. Of Sections	Head	Head OEM #	Type	Section	Section OEM #	Riveted Order No	Riveted Price	Bolted Order No	Bolted Price	
264987	8' LH	(32)		858713	XH7TSCR		SS604921H	-		S35-2058		
264985	8' RH	(33)		858714	XH7TSCR		SS604921H	-		S35-2059		
HTS264987-S	8' LH	(32)	Less Head		XHTSCR		604921H	S35-4156		S35-2972		
HTS264985-S	8' RH	(33)	Less Head		XHTSCR		604921H	S35-4155		S35-2973		
HTS247987-S	7' LH	(28)	Less Head		XHTSCR		604921H	S35-4133		S35-2417		
HTS247988-S	7' RH	(29)	Less Head		XHTSCR		604921H	S35-4534		S35-2418		
706417	7' LH	(28)	Less Head		XHTSCR		604921	S35-4637		S35-2848		
706418	7' RH	(29)	Less Head		XHTSCR		604921	S35-4638		S35-2849		
706415	8' LH	(32)	Less Head		XHTSCR		604921	S35-4634		S35-2850		
706416	8' RH	(33)	Less Head		XHTSCR		604921	S35-4633		S35-2851		
SS706417	7' LH	(28)	Less Head		XH7TSCR		SS604921H	-		S35-2007		
SS706418	7' RH	(29)	Less Head		XH7TSCR		SS604921H	-		S35-2008		
SS706415	8' LH	(32)	Less Head		XH7TSCR		SS604921H	-		S35-2852		
SS706416	8' RH	(33)	Less Head		XH7TSCR		SS604921H	-		S35-2853		
139180	RH Knife Back Overlap Bar								S35-6075		-	

NEW HOLLAND WINDROWER MODELS 1475, 2200, 2300, 2450 AND 2550, HS SERIES HEADER 12HS, 14HS, 16HS

OEM #	Length	No. Of Sections	Head	Head OEM #	Type	Section	Section OEM #	Riveted Order No	Riveted Price	Bolted Order No	Bolted Price
86509304	7' LH	(29)	Headless		XH7TSCR		SS604921H	-		S35-2049	
86509305	7' RH	(29)	Headless		XH7TSCR		SS604921H	-		S35-2050	
86509302	8' LH	(33)	Headless		XH7TSCR		SS604921H	-		S35-2233	
86509303	8' RH	(33)	Headless		XH7TSCR		SS604921H	-		S35-2234	
9826391	9' RH	(37)		9622855, 186617752	XH7TSCR		SS604921H	-		S35-2914	
9826390	9' LH	(37)		9622854, 186617755	XH7TSCR		SS604921H	-		S35-2915	
85605851	9' LH	(37)	Headless		XH7TSCR		SS604921H	-		S35-2063	
86505852	9' RH	(37)	Headless		XH7TSCR		SS604921H	-		S35-2064	
86502118	7' LH	(29)	Yes	9622854	XH7TSCR		SS604921H	-		S35-2037	
					<i>Tiger Shark™</i>					<i>S35-2533</i>	
86502119	7' RH	(29)	Yes	9622855	XH7TSCR		SS604921H	-		S35-2038	
					<i>Tiger Shark™</i>					<i>S35-2534</i>	
86502116	8' LH	(33)	Yes	9622854	XH7TSCR		SS604921H	-		S35-2039	
					<i>Tiger Shark™</i>					<i>S35-2550</i>	
86502117	8' RH	(33)	Yes	9622855	XH7TSCR		SS604921H	-		S35-2040	
					<i>Tiger Shark™</i>					<i>S35-2551</i>	
86616720	9' LH				<i>Tiger Shark™</i>		SS604921H			S35-8000	
86616721	9' RH				<i>Tiger Shark™</i>		SS604921H			S35-8001	

UNIVERSAL SICKLES - NEW HOLLAND 2-1/16" SPACING

Application	Description	Head Number	Riveted Order No.	Riveted Price	Bolted Order No.	Bolted Price
Mowers 450, 451, 455, 456, M/C, 460, 461, 467, 469, 1469, 472, 477, 478, 479,	7' X 7TS Knf	Headless	-		S35-1038	
	9' X 7TS Knf	Headless	-		S35-1039	



NEW HOLLAND 960 FLEX COMBINE (J. E. LOVE)

OEM #	Section Type	No. Of Sections	Size	Section Number	Head Number	Riveted Order No	Riveted Price	Bolted Order No	Bolted Price
271979 CR	XHTSCR	(54)	13'	271981 CR	w/Studs	S35-4657			
271980 CR	XHTSCR	(62)	15'	271981 CR	w/Studs	S35-4660			
273851 CR	XHTSCR	(74)	18'	271981 CR	w/Studs	S35-4658			
273847 CR	XHTSCR	(82)	20'	271981 CR	w/Studs	S35-4659			

**SPLICED SICKLES - SINGLE DRIVE (LESS HEAD) - 3" SYSTEMS
COMBINES WITH 970, 971, 972, & 973 SINGLE DRIVE PLATFORMS**

Complete Sickle - Bolted, 14 Tooth

OEM Number	HTSCR Section Number	No. of Sections	Size	Segments			# Sections To Cut Off	Order No.	Price
				5' LH Head Seg. S35-2820	5' Ext. S35-2825	2' Ext. S35-2824			
851667	694723	59	15'	1	2	-	-	S35-2836	
851663	694723	63	16'	1	2	1	4	S35-2837	
851654	694723	71	18'	1	3	-	8	S35-2838	
851655	694723	79	20'	1	3	-	-	S35-2839	

Note: Use H15-0752 Head if needed.

**SPLICED SICKLES - DOUBLE DRIVE (LESS HEAD) - 1.5" SYSTEMS
COMBINES WITH 970, 971, 972, & 973 DOUBLE DRIVE PLATFORMS**

Complete Sickle

Section Number	No. of Sections	Size	Segments						Order No.	Price
			5' LH Head Seg. S35-2507	5' LH Overlap Seg. S35-2508	5' RH Head Seg. S35-2509	5' RH Overlap Seg. S35-2510	2.5' 2' Ext. Seg. S35-2511	5' 5' Ext. Seg. S35-2277		
SSTJ6700	40	20' LH	1	1	-	-	-	-	S35-2501	
SSTJ6700	38	20' RH	-	-	1	1	-	-	S35-2502	
SSTJ6700	50	25' LH	1	1	-	-	1	-	S35-2503	
SSTJ6700	48	25' RH	-	-	1	1	1	-	S35-2504	
SSTJ6700	60	30' LH	1	1	-	-	-	1	S35-2505	
SSTJ6700	58	30' RH	-	-	1	1	-	1	S35-2506	

Use H15-0060 LH Head, H15-0061 RH Head if needed. (For Tiger Jaw applications only.)

Use H15-0752 Head if needed. (For OEM 1.5" Systems only.)

FORD SICKLE HEADS

Replaces

Number	Description	Application	Order No.	Price
147874	Sickle Head	Ford Mowers 14-94, 95, 96, 97, 175, 176, 257, 258, 259, 260, 501 Series	H15-0297	
242063	Sickle Head	Ford Mowers 14-280, 1, 2, 3, 515 Series	H15-0204	
	Sickle Head	Ford Mower/Cond. 538	H15-0283	
462378R1	Sickle Head	Ford Mowers 505 Series	H15-0281	

NEW HOLLAND SICKLE HEADS

Replaces

Number	Description	Application	Order No.	Price
64693	Sickle Head	NH Mowers 450 (To S/N 87764) 455 (To S/N 88846)	H15-0391	
858740, 143603	Sickle Head	NH Mowers 450 (S/N 87765-) 455 (S/N 88847), 451 & 456	H15-0208	
86507377	Sickle Head	NH Mower/Cond. 460, 461, 467, 469, 490 (Up to S/N 259714)	H15-0866	
577868	Sickle Head	NH Mower/Cond. 472, 477 & 478	H15-0863	
577867	Sickle Head	NH Mower/Cond. 488 & 479 490 (S/N 259715-), 1469 (S/N 220947-)	H15-0862	
289488	Sickle Head	NH Mower/Cond. 474, 489, 492, 1465	H15-0488	
289488 CS	Sickle Head	NH Mower/Cond. Bolted 474, 489, 492, 1465	H15-0016	
TT289488CS	Sickle Head	NH Mower/Cond. Tiger Tooth 474, 489, 492, 1465	H15-0580	
TT143603	Sickle Head	NH Mower/Tiger Tooth 451 & 456	H15-0677	
TT577867	Sickle Head	NH Mower/Cond. Tiger Tooth 479, 488, 1469 (S/N 220947)	H15-0579	
137635	Sickle Head RH	NH 907, 909, 910, 912	H15-0398	
858713	Sickle Head LH	NH Windrowers 1100, 1112, 1118, 1114, 1116	H15-0027	
858714	Sickle Head RH	NH 1100, 1112, 1114, 1116, 1118	H15-0031	
86508155	Sickle Head	NH Windrowers 495 - 1495	H15-0127	
9622854	Sickle Head LH	NH 2450 & 2550	H15-0355	
9622855	Sickle Head RH	NH 2450 & 2550	H15-0356	
MA999		NH 44, 45, 46, 47	H15-0257	
86536345	Sickle Head LH	NH 499, 1496, 1499	H15-0124	
86536346	Sickle Head RH	NH 499, 1496, 1499	H15-0125	

Sickle heads include bushing.

HEAD BUSHINGS FOR NEW HOLLAND SICKLES



B82-0426B

Replaces

Number	Description	Application	Order No.	Price
63841	Head Bushing	Mowers 450 (To S/N 87764), 451 455 (To S/N 88846), 456	B82-0042B	
127610	Head Bushing	Mowers 450 (S/N 87764-) 455 (S/N 88846 & Up), 1496, Windrower 1499	B82-0062B	
134182	Head Bushing	Mower/Cond. 460, 461, 467, 469, 490 (S/N - 259714), 1469	B82-0381B	
254132	Head Bushing	Mower/Cond. 472, 477, 478, 479, 488, 490, 495, 1495	B82-0426B	
76417	Head Bushing	Mower/Cond. 905, 907, 909, 910, 912, 1100, 1112, 1114, 1116, 114, 116, 1118	B82-0068B	
612408A	Bushing Assembly	Mower/Cond. 474, 489, 492, 1465, Combine 972, 973	B82-0211B	

SPLICE KITS



Bolts & Nuts for splice. 12 each per package.

Order No. Price

B55-0049D

Splice Kit 2-1/16" hole spacing. Kit contains 2 straps along with the bolts & nuts.

Order No. Price

C83-0755

VERSATILE SICKLE ASSEMBLIES RIVETED AND BOLTED

S35-4551



LS = Low Shoulder
HS = High Shoulder

OEM #	Section Type	No. Of Sections	Size	Application	Section Number	Description	Head Number	Riveted Order No	Riveted Price	Bolted Order No	Bolted Price
SWA1622CR	R TS CR	(48)	12'	Windrowers	SW 1616 CR	LS	SWA 28253	S35-4551	-	-	-
SWA1783CR	R TS CR	(48)	12'	10, 103, 400	SW 1776 CR	HS	SWA 28253	S35-4869	-	-	-
SWA1786	R TS	(60)	15'	10 Pull Type	SW 1776	HS	SWA 28253	S35-3743	-	-	-
SWA1786CR	R TS CR	(60)	15'		SW 1776 CR	HS	SWA 28253	S35-4176	-	-	-
SWA25571CR	R TS CR	(60)	15'		SW 1616 CR	LS	SWA 28253	S35-4985	-	-	-
SWA25571	R TS	(60)	15'		SW 1616	LS	SWA 28253	S35-3450	-	-	-
SWA1789	R TS	(72)	18'		SW 1776	HS	SWA 28253	S35-3890	-	-	-
SWA1789CR	R TS CR	(72)	18'		SW 1776 CR	HS	SWA 28253	S35-4275	-	-	-
SWA25572CR	R TS CR	(72)	18'		SW 1616 CR	LS	SWA 28253	S35-4988	-	-	-
SWA25572	R TS	(72)	18'		SW 1616	LS	SWA 28253	S35-3926	-	-	-
SWA3311	R TS	(80)	20'		SW 1776	HS	SWA 28253	S35-3273	-	-	-
SWA3311CR	R TS CR	(80)	20'		SW 1776 CR	HS	SWA 28253	S35-4274	-	-	-
SWA25573CR	R TS CR	(80)	20'		SW 1616 CR	LS	SWA 28253	S35-4991	-	-	-
SWA35743	R TS	(96)	24'		SW 1776	HS	SWA 28253	S35-3373	-	-	-
SWA54834	R TS CR	(60)	15'	Windrowers 4400 Self Propelled	SW 1616 CR	LS	SWA 28509	S35-4492	-	-	-
SWA54840	R TS CR	(72)	18'		SW 1616 CR	LS	SWA 28509	S35-4493	-	-	-
SWA54846	R TS CR	(80)	20'		SW 1616 CR	LS	SWA 28509	S35-4494	-	-	-
SSVS4-SB	H7TS	(16)	4 'Ext.	Windrowers* 10, 103, 400. Pull Type 10, 4400	SSVS1616BN	LS	Less Head	-	-	S35-1088	-
SSVS15-SB	H7TS	(60)	15'		SSVS1616BN	LS	Less Head	-	-	S35-1084	-
SSVS18-SB	H7TS	(72)	18'		SSVS1616BN	LS	Less Head	-	-	S35-1085	-
SSVS20-SB	H7TS	(80)	20'		SSVS1616BN	LS	Less Head	-	-	S35-1086	-
SSVS22-SB	H7TS	(88)	22'		SSVS1616BN	LS	Less Head	-	-	S35-1087	-
*Note: Bolted sickles use B55-0955D 5/8" Oval CTSK Shoulder Bolts.											
6832174	H TS CR	(28)	7' LH	4814 Auger Header	700705300		6821078 LH	S35-4390	-	-	-
6832224	H TS CR	(29)	7' RH		700705300		6821136 RH	S35-4391	-	-	-
SSBN6832174	XH7TS CR	(28)	7' LH		SS700705300		6821078 LH	-	-	S35-2285	-
SS6832224	XH7TSCR	(28)	7' RH		SS700705300		6821136 RH	-	-	S35-2286	-

NEW HOLLAND

1-YEAR WARRANTY!

All items come with a

1-year warranty. Contact customer service with any questions.

VERSATILE SICKLE HEADS

Replaces

Number	Description	Application	Order No.	Price
SWA 28253	Sickle Head w/Bushing	Versatile - Windrower 10, 103, 400, Pull Type 10	H15-0308	
SWA 28509	Sickle Head w/Bushing	Versatile - Windrower 4400	H15-0458	
SW 1740	Head Bushing, Silent Block	Versatile - All Windrowers, 10, 103, 400, 4400	B82-0437B	
6821078	Sickle Head LH	Versatile - 4814 Auger Heads	H15-0390	
6821136	Sickle Head RH	Versatile - 4814 Auger Heads	H15-0301	

DISC MOWER KNIVES

OEM Number	Application	Hole Length Inches	Dia. Inches	Style	Shape	Bolt Order No	6 Blades Order No	Price	25 Blades Order No	Price
274230	All 442 & 462	3.70	.640"	1	Flat	B55-0358D	B45-6175D		B45-6175	
784220	411 to 711915, 453, 463	4.84	.717"	4	LH Twisted	B55-0344D	B45-6565D		B45-6565	
784221		4.84	.717"	4	RH Twisted	B55-0344D	B45-6566D		B45-6566	
274096	462 to 51121643	3.66	.640"	4	LH Twisted	B55-0358D	B45-6996D		B45-6996	
274097		3.66	.640"	4	RH Twisted	B55-0358D	B45-6997D		B45-6997	
766726	462 after 51121643, 452, 442	3.74	.640"	4	LH Twisted	B55-0358D	B45-6122D		B45-6122	
766727		3.74	.640"	4	RH Twisted	B55-0358D	B45-6123D		B45-6123	
853819	408, 411, 412, 415	4.21	.717"	4	RH Twisted	B55-0344D	B45-6568D		B45-6568	
853820		4.21	.717"	4	LH Twisted	B55-0344D	B45-6569D		B45-6569	
9847684	615, 616, 617, 720HD, 750HD, 1409, 1410, 1411, 1412, 1431, 1432, 1441, 1442, 2331, 232, 2353, 2355, 2358, DCX101, DCX131, DCX161, RDX161, H6730, H6740, H6750, H7220, H72230H H7320, H7330	4.21	.9"	5	LH Twisted	N/A	B45-6721D*		N/A	
9847683		4.21	.9"	5	RH Twisted	N/A	B45-6720D*		N/A	
113385A1	18° Top Bevel. 3204, 3205, 3260, 3309	4.76	.89	5	LH Twisted	B55-0355D	B45-6576D		N/A	
113384A1	18° Top Bevel. 3204, 3205, 3260, 3309	4.76	.89	5	RH Twisted	B55-0355D	B45-6577D		N/A	
700715575	18° Bottom Bevel. 725, 8850, DC515, 8309, 8312, 8315	4.21	.728		LH Twisted	B55-0344D	B45-6572D		B45-6572	
700715576	18° Bottom Bevel. 725, 8850, DC515, 8309, 8312, 8315	4.21	.728		RH Twisted	B55-0344D	B45-6573D		B45-6573	
700715575	18° Top Bevel. 725, 8850, DC515, 8309, 8312, 8315	4.21	.728	5	LH Twisted	B55-0344D	B45-6725D		B45-6725	
700715576	18° Top Bevel. 725, 8850, DC515, 8309, 8312, 8315	4.21	.728	5	RH Twisted	B55-0344D	B45-6726D		B45-6726	
84271023					RH Twisted		B45-6578D			
84271205					LH Twisted		B45-6579D			

*13° Angle Blade

HOLD DOWN CLIPS



C45-0503



C45-0006

Style	Description	Application	Order No.	Price
NON-ADJUSTABLE				
Steel	Lo-Arch	Used w/ G81-0120 Stub Guards	C45-0502	
Steel	Hi-Arch	Used w/ G81-0120 Stub Guards	C45-0503	
Cast	Lo (MA812)	Mowers All	C45-0020	
Steel	Lo-Arch	Bolted Sickles	C45-0692	
Steel	Hi-Arch	Bolted Sickles	C45-0693	
Steel	Lo-Arch Hardened	Versatile - For Rivets	C45-0419	
Steel	Lo-Arch Hardened	Versatile - For Bolts	C45-0951	

Style	Description	Application	Order No.	Price
ADJUSTABLE				
Cast	Lo-Arch	Most Mowers, Conditioners & Swathers except Versatile	C45-0006	
Cast	Hi-Arch		C45-0007	
Cast	Clip Arch Only, Low	For C45-0006	C45-0008	
	Rubber Elastomer	Use with C45-0006 & C45-0007	R36-0001	
Steel	Lo-Arch, Stamped	Most Combines, Mowers, & Windrowers Except Versatile, Hart-Carter, & Love	C45-0040	

WEAR AND GUARD PLATES

Replaces Number	Description	Application	Order No.	Price
142570	Guard Plate	Mowers All Ford Fits G81-0778, G81-0821, 10/Bx	P44-0603	
271967, 26616	Wear Plate, 6"	Combines Floating Bars New Holland	P44-0417	
W 50	Wear Plate, 5-7/8", 141021 Slotted Holes w/3" Spacing	Swathers, combines, all Ford mowers	P44-0591	
FLW 70	Wear Plate 7', Full Length	Mowers	P44-0412	
FLW 90	Wear Plate 9', Full Length	Mowers	P44-0413	
FLW24HT	Wear Plate 2', Heat Treated	Tiger Jaws	P44-0200	



GUARDS - FORD AND VERSATILE

Replaces Number	Description	Application	Order No.	Price
141009	Center-Malleable	Mowers Except 505	G81-0778	
FS 72-2, BU280, 290385	Two Prong-Forged	Mower/Cond. 535	G81-0065	
FS 92-2, BU206, 110-32327	Two Prong-Forged	Mower/Cond.	G81-0140	
FC 85-2, BU210, 483500R3	Two Prong-Forged	Mower/Cond. 538	G81-0183	
MC2041Z	Center -Malleable	Mower 505	G81-0830	
FS 67-2, BU290, SW 1605	Two Prong-Forged	All Versatile-Windrowers	G81-0197	



GUARDS - NEW HOLLAND



OEM Number	Replaces Number	Description	Application	Order No.	Price
219190	FS 93-2, BU218	Two Prong-Forged	NH Mowers	G81-0184	
219190	FS 93-DH	Two Prong, Double Heat Treated		G81-0144	
858778	FS 81-DH, BU215H	Two Prong-Forged, Double Heat Treated	Windrowers & M/C	G81-0098	
273846	FS 81-2, BU215A	Single Heat Treat	All Windrowers & M/C except 451	G81-0155	
	FC 90-2, BU275	Two Prong-Forged	NH Combines Floating Bars (Love)	G81-0196	
	FS 86-2, BU250	2 Prong-Forged (Stub Guard)	All NH Windrowers & M/C	G81-0120	
287459	BU251	Grd. Clip (Lo-Arch)	Use w/ G81-0120 Stub Guard	C45-0502	
288074	BU252	Grd. Clip (Hi-Arch)	Use w/ G81-0120 Stub Guard	C45-0503	
	BU260	2 Prong Forged Tie Guard		G81-0085	
	BU261	Grd. Clip (Lo-Arch)	Use w/ G81-0085 Tie Guard	C45-0500	
	BU262	Grd. Clip (Hi-Arch)	Use w/ G81-0085 Tie Guard	C45-0501	
110-32327, 110-32342			NH 536	G81-0197	
86615983, 87042360	215DH	Center Guard	971, 973, 71C, 73C, 74C Headers; All Windrowers & M/C	G81-0093	

MALLEABLE GUARDS

Replaces Number	Description	Application	Order No.	Price
FD 800	Center Guard	Ford Mowers	G81-0807	
FD 800-R	Outer Guard	Ford Mowers	G81-0808	
1-1/4 CSZP	Rivet, 1-1/4" #51/2 CS	Use with P44-0667 Guard Plate	R36-0468D	
141009	Center Guard	Ford Mowers Except 505	G81-0778	
MC2041Z	Center Guard	Ford 505	G81-0830	

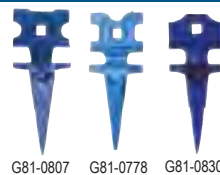

GRASS BOARD

For Mowers



Order No.	Price
B52-0615	

GUARD BOLT KIT

Universal No. 3 Head Guard Bolts and Conical Nuts for Cutter Bars 7' or Smaller

Size/No. In Package	Order No.	Price
7/16" x 1-3/8" (12)	B55-0700	
7/16" x 1-11/16" (18)		
7/16" Nuts (30)		



PITMAN WOODS AND STRAPS - FORD

Description	Application	Order No.	Price
37-11/16" Pitman Wood	Mower 14-92, 501	P38-0520	
46-7/16" Pitman Wood	Mower 14-93	P38-0525	
37-1/2" X 1-7/16" X 1-1/8"	Universal	P35-0560	



RAKE AND BALER TEETH

Number	Description	Application	Order No.	Price
146545	2 Prongs	Ford Rake	T16-0340	
64562	1 Prong Spring Tooth	NH 55, 56B, 57, 256, 258, 259, 260 Rakes	T16-0370	
792493	Tooth Clip	Used with T16-0370, 10 per Bag	C45-0493B	
40917, 33549				
65668 L	1 Prong Spring Tooth, LH	NH 56B, 57, Rakes 259, 216, 256, 258	T16-0154	
139041 R	1 Prong Spring Tooth, RH	260, 269 & 216 Rakes	T16-0166	
127566	2 Prong Spring Tooth	NH Balers 78 & Super 68, 273, 276	T16-0158	
131673, 86551419	2 Prong Spring Tooth	Fits pickup on Super Sweep Baler & Large Round Balers	T16-0162	
76517	Reel Tooth	NH 460, 461, 467, 468, 472, 474, 488, 492, 903, 907, 909, 912, 1100, 1112, 477, 479 479 Mower Conditioners & Windrowers	T16-0032	
RMT 1	1 Prong	Univ. Rubber Mount Tooth fits Round Bar Rakes	T16-0182	
850613D	1 Prong LH Rake Tooth	Allen and New Holland RolaBar Rakes, Made in USA	T16-0170	
850614D	1 Prong RH Rake Tooth	Allen and New Holland RolaBar Rakes, Made in USA	T16-0171	
RMT-1D	1 Prong Univ Rubber Rake Tooth	Universal all Round Bar & Parallel Bar Rakes, Made USA	T16-0186	

RAKE WHEELS AND TINE

Replaces Number	Description	Order No.	Price
210.621	Sitrex Wheel Rake Tine	T16-0820	
NH Rakes	HD .275" Diameter RH, Cream	W16-0801	
NH Rakes	HD .275" Diameter LH, Cream	W16-0802	

Replacement Tine Part Number T16-0815 or T16-0820

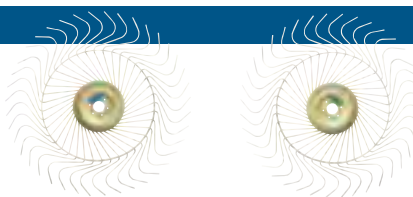

HUB ASSEMBLY



Order No.	Price
H16-1000	

COMBINE REEL TEETH - 1 PRONG

Replaces Number	Application	Pkg. Qty.	Order No.	Price
N66A	Reel-Bat-Tine with wood bats.	100	T16-0183	
N67A	Reel-Bat-Tine	100	T16-0767	
782551, 1989438C1, AH136689, AH153175	2 pc. M/L Reel Tine w/clamps	100	T16-0720	
782226, 1989438C1, AH136689, AH153175	2 pc. M/L Reel Tine w/clamps	10/Bag	T16-0715	
HA100MLT	M/L Reel Tine Only, Less Clamps; For T16-0720 & T16-0715	100/Box	T16-0725	
HA20SC	Replacement Screw for T16-0715 & T16-0725	20/BB	B55-0096D	



BALE COUNTER



Reads up to 99,999, 4 hole mounting plate, push button reset, adjustable side arm.

Order No.	Price
T55-0002	

HERSCHEL 6" 2-PIECE POLY TINES FOR COMBINE PIPE REELS



Description	Pkg. Qty.	Order No.	Price
Tine & Clamp	100/Box	T16-0740	
Tine & Clamp	10/Box	T16-0745	
Tine ONLY	100/Box	T16-0750	

PLASTIC BEARINGS AND HARDWARE FOR PIPE REEL



Description	Order No.	Price
Outside Tine Bracket. Use with T16-0730 to replace LH or RH original steel reel end fingers. Fits Herschel Reel Conversion Kits. Sold individually.	B65-0120	
Plastic Bearing Kit. 6/box. Includes 6 bases, 6 caps, 6 U-bolts, & 12 nuts. Fits reels with Wood Bats used on NH 960, 970, & 972 series. Fits reels with Tear Drop bats used on NH 971 & 973 series.	B15-0915	
Plastic Bearing Kit. 6/box. Includes 12 bearing halves, 6 bolts, & 6 nuts. Fits pipe reels with Plastic Tines used on NH 971 & 973 series.	B15-0925	

POLY REPLACEMENT PARTS FOR HERSCHEL SPECKLED POLY KITS

For New Holland / Ford New Holland - 972 Header

Replaces Number	Size Length x Width	Rivets Required	Qty. Required	Order No.	Price
NH972-29	23" x 29"	12	6 6	P44-1214	
NH972-23	23" X 23"	10	2	P44-1172	

POLY COVER PLATES FOR WINDROWERS

Fits 1112, 1114, 1116, 1118.
• 15" x 19-1/2".
• 8 Rivets required (not included)

Order No.	Price
P44-1794	

STRAW CHOPPER KNIFE SET FOR NH COMBINES



Set includes 3 knives, 3 bushings, 3 nuts, 3 bolts.

Replaces NH-277056, 88374

Order No.	Price
C83-0601	

NEW HOLLAND

POLY SKID SHOE KITS

- 1/4" ultra high molecular Polyethylene material is super slick & lightweight.
- Has nearly the exact same "sliding" properties as Teflon.
- Prevents losing valuable harvest days due to wet weather.
- Allows you to harvest in wet conditions or clay with no sticky build-up.
- Easy to install, just drill holes in steel plates and fasten with Hammer rivets furnished in all Kits.
- Precut and formed. All Plates come with countersunk drilled holes.
- Protects your metal skid shoes so they never wear out.
- Furnished with end plate, wobblebox plate.



P44-1134

Sickle

Size	Application	Color	Order No.	Price
20'	972 Combine	Speckled	P44-1119	
15'	CNH 973 & CIH 2020	Black	P44-2015	
18'	CNH 973 & CIH 2020	Black	P44-2018	
20'	CNH 973 & CIH 2020	Black	P44-2020	
22'	CNH 973 & CIH 2020	Black	P44-2022	
24'	CNH 973 & CIH 2020	Black	P44-2024	
25'	CNH 973 & CIH 2020	Black	P44-2025	
30'	CNH 974 & CIH 2062	Black	P44-2630	
36'	CNH 974 & CIH 2062	Black	P44-2636	

AUGER FINGERS



Durable and Flexible.

Replace the original metal fingers in combine augers.

Poly fingers are strong and resilient and will bend 10° past the breaking point of metal fingers. Broken metal fingers can do costly damage to rotors and cylinders by gouging or poking through the auger. A loose metal finger can cut an auger in half in 15 seconds. Poly fingers will disintegrate as they go through the combine. They are literally ground to a dust that will not damage internal working parts of the combine like rotors and cylinders.

Application	Pack Qty	Order No.	Price
NH Auger Finger Only	24 PK	P44-0109	
NH Auger Finger Kit w/hardware	1 Kit	P44-0111	
Universal Guide	Each	P44-0115	

HAMMER RIVETS AND TOOL

Size	Description	Application	Pkg Qty	Order No.	Price
3/16" x 5/16"	Large Head	NH 972, NH Windrower	50/BB	R36-0655	
1/4" x 3/8"	Large Head	NH Windrower Auger Liner	50/BB	R36-0653	
		Hammer Rivet Tool		T55-0812	



T55-0812

IDLER PULLEYS BY AETNA - FLAT FLANGED

B= Center Hole Diameter is 5/8"

Replaces Number	A Outside Dia.	C Overall Width	Order No.	Price
127645	7"	1-5/16"	P83-0623	



**24-HOUR SHOPPING
AVAILABLE AT
HERSHELPARTS.COM**

DISC MOWER KNIVES

See pages 105 - 109 for a complete listing of our disc mower knives.



- Meets or Exceeds ISO 5718 Standards.
- Edges Are Formed, Not Ground To Prevent Chipping or Breaking.
- Made From USA 10B38(Boron) Steel.
- Entire Blade Is Heat-Treated to a RC Hardness of 45-52.



BALE SPEARS

BETTER QUALITY. BETTER PRICE.

Assembling Advice For Square Tines



See Page 187 For A Complete Listing Of Our New Bale Spears!

- High Tensile Strength Heat Treated Steel
- Standard Duty 2500# 1-3/4" Diameter
- Heavy Duty 3500# 1-3/4" Diameter
- Threaded Spears Include Nut

Blackwelder.....	62	New Idea.....	67
Sections.....	62	Guards, Forged & Malleable.....	67
Sickle Assemblies, Riveted.....	62	Hold Down Clips.....	67
		Pitman Wood.....	67
Cereal.....	62	Rake Teeth.....	67
Section.....	62	Sections.....	67
Sickle Assemblies, Riveted.....	62	Sickle Assemblies, Riveted & Bolted.....	67
		Sickle Heads.....	67
Caterpillar.....	62	Universal Sickles - Bolted.....	67
Section.....	62		
Easy Ricer Kits.....	See Conv. Kit Tab	Owatonna.....	68
		Guard Bolts.....	68
Field Queen.....	62	Guards.....	68
Clips.....	62	Sections.....	68
Guards.....	62	Sickle Assemblies, Riveted & Bolted.....	68
Sections.....	62	Wear Plate.....	68
Sickle Assemblies, Riveted.....	62		
		Rowse.....	69
FMC.....	63	Guards.....	69
Sections.....	63	Sections.....	69
Sickle Assemblies, Riveted.....	63	Sickle Assemblies, Bolted.....	69
Sickle Head.....	63	Sickle Assemblies, Riveted.....	69
Gehl.....	63	Schumacher.....	69
Guards.....	63		
Hold Down Clips and Straps.....	63	Triumph.....	70
Rake Teeth.....	63	Guards, Malleable & Bolts.....	70
Sections.....	63	Hold Down Clip.....	70
Sickle Assemblies, Riveted.....	63	Pitman Straps, Spring, Latch Fork.....	70
Universal Sickles.....	63	Sections.....	70
Windrower Teeth.....	63	Sickle Assemblies, Riveted & Bolted.....	70
		Sickle Head.....	70
Hart Carter.....	64	Wear Plate.....	70
Flexible Reel Tines.....	64		
Forged Guards.....	64	Vermeer.....	70
Guard Bolts.....	64		
Hammer Rivet Tool.....	64	White.....	71
Hammer Rivets.....	64	Forged Guards.....	71
Hold Down Clips.....	64	Head Adapter Bar for White.....	71
Poly Replacement Parts.....	64	Kwik Cut System for White.....	71
Poly Skid Shoe Kits.....	64	Plastic Bearings for Pipe Reel Kits.....	71
Poly Tine.....	64	Rake Teeth.....	71
Sections & Bolts.....	64	Reel Tines.....	71
Sickle Assemblies, Riveted.....	64	Sickle Assemblies, Bolted.....	71
Sickle Heads.....	64		
Wear Plates.....	64		
J.E. Love.....	65		
Forged Guards & Bolts.....	65		
Poly Skid Shoe Plate.....	65		
Sections & Bolts.....	65		
Sickle Assemblies, Riveted.....	65		
Tiger Jaw Replacement Sickles.....	65		
Wear Plates & Hold Down Clips.....	65		
Johnson.....	66		
Hold Down Clip.....	66		
Sections.....	66		
Sickle Assemblies, Riveted.....	66		
Sickle Head.....	66		
Kosch.....	66		
Guards & bolts.....	66		
Hold Down Clips.....	66		
Pitman Woods.....	66		
Plates - Guard, Wear, Shoe.....	66		
Sections.....	66		
Sickle Assemblies - Riveted.....	66		
Sickle Head.....	66		
Universal Mower Sickles.....	66		

BLACKWELDER TOMATO HARVESTERS

SICKLE ASSEMBLIES - RIVETED

Replaces Number	Size	Description Section / No. Used	Section Number	Head Number	Order No	Price
49399	5.5'	XHSM (22)	49152	Less Head	S35-3399	

SECTIONS

Replaces Number	Size	Description	Rivet Used	Pkg. Qty.	Order No	Price
49152	3" x 3 1/4"	XHSM Btm. Ctsk. 5/8" CS	5/8" CS	10	S20-1152	

CEREAL (CCIL)

SICKLE ASSEMBLIES - RIVETED

Cereal Swathers, 500 Series
Less Head, Section Number 1145

Replaces Number	Size	Description Section / No. Used	Order No	Price
14021, 10813	15'	XHUS (59)	S35-3156	
14022, 10816	18'	XHUS (71)	S35-3158	

SECTIONS

Cereal Swathers

S20-5244



Replaces Number	Size	Description	Rivet Used	Pkg. Qty.	Order No	Price
1145	3" x 3-1/4"	XHUS	1/2 OH	10	S20-5244	
1146	3" x 3-1/4"	XHUS w/1/4" Hole	1/4" x 5/8" OH	10	S20-5098	

CATERPILLAR

SECTIONS

Lexion Combines With "F" Series Platform
3" x 3.2" long. 1/4" bolt holes. 2" spacing.



Replaces Number	Description	Order No	Price
149-3303	XHTS	S20-3478	
149-3303	XH7TS	S20-4517	

GUARDS

G81-0199



G81-0200



Fits/Description	Replaces OEM No.	Replaces Order No	Price
Caterpillar-Claas Combines	676235N	HA207	G81-0198
Caterpillar-Claas Combines	676295N	HA208H	G81-0199
Double Heat Treat			
Caterpillar-Lexion Combines	767265.1	HA209	G81-0200

FIELD QUEEN

SICKLE ASSEMBLIES - RIVETED

Hay Harvester 420, 620



Replaces Number	Size	Description Section / No. Used	Section Number	Head Number	Order No	Price
6272959	12'	H TS CR (49)	049254	6193577	S35-4881	
6272967	14'	H TS CR (57)	049254	6193577	S35-4879	

SECTIONS

Hay Harvester 420, 620

S20-4013



S20-6339



Replaces Number	Size	Description	Rivet Used	Pkg. Qty.	Order No	Price
457607R2	3" x 3-1/4"	XHUSCR	9/16 OH	10	S20-6339	
049213	3" x 3-1/4"	XHTSCR	1/2 OH	10	S20-4013	
049254	3" x 3-1/4"	XHTSCR	9/16 OH	10	S20-4564	

GUARDS, SICKLE HEAD, AND CLIPS



Replaces Number	Description	Application	Order No	Price
FS 65-2	Two Prong-Forged	Hay Harvester All	G81-0035	
FT 77-2, HA260	Two Piece Center-Forged (Tie Guard)	Windrowers 420, 620	G81-0085	
FS 66-2, HA245	Center-Forged	Windrowers 420, 620	G81-0192	
BSL600, 241216	Clip (Lo-Arch)	M/C. All Windrowers	C45-0692	
FT78-2, BT261	Clip (Lo-Arch)	M/C. Windrowers all w/2-Piece Guard	C45-0500	
FT79-2, BT262	Clip (Hi-Arch)	M/C. Windrowers all w/2-Piece Guard	C45-0501	
L600ADJ	Clip (Lo-Arch), Adjustable Stamped Steel	Most Mowers & Windrowers	C45-0040	

FMC TOMATO HARVESTERS

SICKLE ASSEMBLIES - RIVETED

Replaces Number	Size	Description Section / No. Used	Section Number	Section Number	Order No	Price
5751487-S	5'	XH SM (20)	5751132	Less Head	S35-3064	
5751487	5'	XH SM (20)	5751132	2368964	S35-3063	



SECTIONS

Replaces Number	Size	Description	Rivet Used	Pkg. Qty.	Order No	Price
5751132	3" x 3-1/4"	XH SM	5/8" CS	10	S20-1152	



GEHL

SICKLE ASSEMBLIES - RIVETED

Replaces Number	Size	Description Section No/Used	Application	Section Number	Head Number	Order No	Price
060969	9' 3"	XH US CR (38)	Mower/Cond. 880 & 1090	060635	Head Excluded	S35-4203	
6582522	9'	XH TS CR (37)	Mower/Cond. 2160	049254	6582530	S35-4318	
6272959	12'	XH TS CR (49)	M/C 2230 Swing Frame	049254	6193577	S35-4881	
6832174	14' LH	XH TS CR (28)	M/C 2262 Swing Frame	049254	6821078	S35-4390	
6832224	14' RH	XH TS CR (29)	M/C 2262 Swing Frame	049254	6821136	S35-4391	

UNIVERSAL SICKLES - BOLTED

Fits 880, 1090, 2130, 2160

Description	Head Number	Order No	Price
7' XH7TS Knf	Headless	S35-1038	
9' XH7TS Knf	Headless	S35-1039	

SECTIONS

- 5/8" OH Rivet
- 10 per package

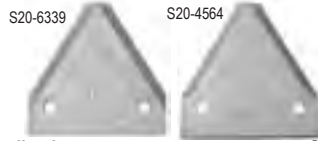

Replaces Number	Size	Description	Application	Order No	Price
060635	3" x 3-3/16"	XHUSCR	M/C 770, 880, 1070, 1090	S20-6339	
050056	3" x 3-3/16"	XHTSCR	M/C HK440 2230 & 2262 Swing Frame	S20-4564	

WINDROWER / RAKE TEETH

Fits Hesston Rake Models 207, 208, 216, 217, 218.

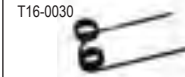

Replaces Number	No. Of Prongs	Pkg Qty	Order No	Price
611181	2	100	T16-0030	

GUARDS



Replaces Number	Replaces OEM No.	Description	Application	Order No	Price
MC 2041Z	H 7540, MA188	One Prong-Malleable	Mower/Cond. MA188	G81-0830	
FS 65-2, HA270	044779	Two Prong-Forged	MA206A	G81-0035	
FS 86-2, HA250	049312, 060494	Stub 2 Prong-Forged	HK108, HK440, 770, 880, 1070, & 1090	G81-0120	
FS 82-2, HA220	059827, 072057	Two Prong-Forged	770, 880, 1070, 1090	G81-0185	
FS 66-2, HA245	748178, 611179, 611902	Two Prong-Forged	M/C 2230, 2240 & 2262 Swing Frame	G81-0192	
HA206	110-32342			G81-0140	

HOLD DOWN CLIPS

Used w/G81-0120 Stub Guard



Replaces Number	Description	Order No	Price
FT 87-2	Clip (Lo-Arch)	C45-0502	
FT 88-2	Clip (Hi-Arch)	C45-0503	

Note: FT 87-2 & FT 88-2 Clips used on Guard No. FS 86-2

HART CARTER

POLY SKID SHOE KITS

- 1/4" ultra high molecular Polyethylene material is super slick and lightweight.
- The abrasion resistance of this plastic is 1.8 times greater than steel.
- Allows you to harvest in wet conditions or clay with no sticky build-up.
- Easy to install, just drill holes in steel plates and fasten with Hammer rivets furnished in all Kits.
- Precut and formed. All Plates come with countersunk drilled holes.

Sickle

Size	Application	Color	Order No	Price
15', 16'	HC Generation III	White	P44-1090	
18'	HC Generation III	White	P44-1091	
20'	HC Generation III	White	P44-1092	
15'	Hart Carter	White	P44-1090	
18'	Hart Carter	White	P44-1091	
20'	Hart Carter	White	P44-1092	
22'	Hart Carter	White	P44-1093	
24'	Hart Carter	White	P44-1094	

POLY REPLACEMENT PLATES FOR HERSCHEL SPECKLED POLY KITS

Hart Carter - Generation III

Replaces Number	Size Length x Width	Rivets Required	Qty. Required				Order No	Price
			13'	15'	16'	20'		
HC3-18	7" x 18"	8	3	4	4	6	8	P44-1121
HC3-33	7" x 33"	12	1	1	1	1	1	P44-1122
HC3-44	7" x 44"	16	1	1	1	1	1	P44-1123

HAMMER RIVETS

50/BB

Replaces Number	Size	Order No	Price
SPK9	3/16"x5/16"	R36-0655	

HAMMER RIVET TOOL

Order No	Price
T55-0812	

SICKLE ASSEMBLIES - RIVETED



Hart Carter Generation III and AC Series 2 Floating Bar (Wobble Drive Hd.)

880644	XHTSCR 53	13'	277444	880662	S35-4230
880645	XHTSCR 61	15'	277444	880662	S35-4231
880649	XHTSCR 65	16'	277444	880662	S35-4232
880646	XHTSCR 73	18'	277444	880662	S35-4233
880647	XHTSCR 81	20'	277444	880662	S35-4234
880726	XHTSCR 97	24'	277444	880662	S35-4236

SICKLE HEAD

Combines Floating Bar Newest Style Wobble Drive Head Gen. III



Replaces Number	Order No	Price
880662	H15-0194	

6" WEAR PLATE

For All Combines with Floating Bar



Replaces Number	Order No	Price
MC 468	P44-0417	

SECTIONS AND BOLTS

Replaces Number	Size	Description	Application	Rivet Used	Pkg. Qty.	Order No	Price
277444	3" x 2-1/2"	XHTSCR	ALL Combines, Floating Bar	5/8 CS	10	S20-4462	
SS277444	3" x 2-1/2"	XH7TSCR	ALL Combines, Floating Bar	5/8 CS	10	S20-4322	
9/16" CS	9/16" CS	Section Bolt	Replaces rivets for Bolt-On convenience		20	B55-0056D	
1" CS	1" CS	Head Bolt	Replaces rivets for Bolt-On convenience		10	B55-0058D	



HONEY BEE

SECTIONS

Replaces Number	Description	Application	Pkg. Qty.	Order No	Price
26208	XH7TSCR	Honey Bee Heads With	10	S20-4498	
26208	XH7TS	Schumacher Easy Cut System	10	S20-3513	
26208	XHSRKCRCR		10	S20-8498	

BOLTS

Replaces No.	Description	Pkg. Qty.	Order No	Price
420100012, 61711	Section Bolt & Nut M6-1.0x16	50/bb	B55-0075D	
011006018, 61521 01106001, 62758	Head Bolt Kit. (6) M6-1.0x18 & (3) M6-10.x28	9/bb	B55-0079D	

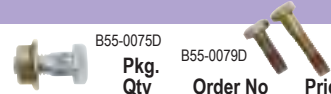

JE LOVE

TIGER JAWS II
SPliced REPLACEMENT SICKLES

BOLTED - Less Head
Fits Both the Original Tiger Jaws and the Tiger Jaws 2000 Series, now all with Super 7 Sections.

Size	Order No	Price
1-Piece Universal		
16'	S35-2153	
20'	S35-2155	

Size	Order No	Price
Spliced Universal		
4'	S35-2860	
5'	S35-2276	
8'	S35-2861	
8.5' Drive Head Segment	S35-2862	

SICKLE ASSEMBLIES - RIVETED

Combines, Floating Bar (Soy Beans)



Replaces Number	Size	Description Section / No.	Section Number	Head Number	Order No	Price
CF 13C2	13'	XH TS CR (54)	L192D CR	w/Studs	S35-4657	
CF 15C2	15'	XH TS CR (62)	L192D CR	w/Studs	S35-4660	
CF 16C2	16'	XH TS CR (66)	L192D CR	w/Studs	S35-4882	
CF 18C2	18'	XH TS CR (74)	L192D CR	w/Studs	S35-4658	
CF 20C2	20'	XH TS CR (82)	L192D CR	w/Studs	S35-4659	
CF 22C2	22'	XH TS CR (90)	L192D CR	w/Studs	S35-4252	
CF 24C2	24'	XH TS CR (98)	L192D CR	w/Studs	S35-4253	

6" WEAR PLATE

Standard and Adjustable.
Replaces L220.



Order No	Price
P44-0417	

SHORT LINES

POLY SKID SHOE PLATE

- 1/4" ultra high molecular Polyethylene material is super slick and lightweight.
- The abrasion resistance of this plastic is 1.8 times greater than steel.
- Has nearly the exact same "sliding" properties as Teflon.
- Prevents losing valuable harvest days due to wet weather.
- Allows you to harvest in wet conditions or clay with no sticky build-up.
- Easy to install, just drill holes in steel plates and fasten with Hammer rivets.
- All Plates come with countersunk drilled holes.
- Protects your metal skid shoes so they never wear out.

Replaces Number	Description	No. Rivets Required	Order No	Price
SPK9	3/16" x 5/16" Hammer Rivet (50/Bag)		R36-0655	

* Some cutting required. No rivets included.

FORGED GUARDS AND BOLTS

Replaces Number	Description	Size	Pkg. Qty.	Order No	Price
FC90-2, BU275, LB208, LB214, HA275	2-Prong Forged		Ea.	G81-0196	
TJ44-4A, LB 216	4-Prong Tiger Jaw System		Ea.	G81-0581	
L1316, 17	#3 Guard Bolt	7/16" x 1-1/2"	50	B55-0260	
LB318	#3 Guard Bolt	7/16" x 1-3/4"	50	B55-0265	



SECTIONS AND BOLTS

Replaces Number	Size	Description	Application	Rivet Used	Pkg. Qty.	Order No	Price
L 191	3" x 3-3/16"	XHUS	Green Pea Windrowers	9/16 OH	10	S20-5246	
L192DS7	3" x 3"	XH7TS	TR 308, TR 310	5/8"	10	S20-3370	
L 192 D CR	3" x 3"	XHTSCR	TR 409, TR 510	5/8 CS	10	S20-4608	
TJ6000	3" x 3-1/4"	XHTJCR	Combine w/Tiger Jaws, King Kut		1	S20-4638	
SSTJ6000	3" x 3-1/4"	XH7TJCR			10	S20-4316	
Section Bolt	5/8" CS	Bolt w/Nut	CS Section Bolt (To Replaces Rivets)	N/A	20	B55-0057D	
Head Bolt	1" CS	Bolt w/Nut	CS Head Bolt (To Replace Rivets)	N/A	10	B55-0058D	

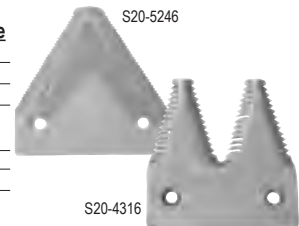

JOHNSON TOMATO HARVESTERS

SICKLE ASSEMBLIES - RIVETED

Replaces Number	Size	Description Section / Qty	Section Number	Head Number	Order No	Price
707510	5'	XHSM (20)	49152	Less Head	S35-3023	
713610	5'	XHSM (20)	49152	70711	S35-3024	

HOLD DOWN CLIP

Cast hold down clip. Replaces 575-1362.

Order No. C45-0469

SECTION

10 Per Package. 3" x 3-1/4"

Replaces Number	Description	Rivet Used	Order No	Price
49152	XHSM Btm. Ctsk.	5/8" CS	S20-1152	



KOSCH

SECTIONS

For All Mowers.
3" x 3-1/4".

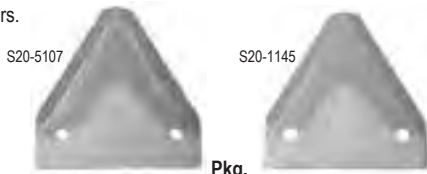

Replaces Number	Description	Rivet Used	Pkg. Qty.	Order No	Price
K 164	XHSM	9/16 OH	10	S20-1145	
K 164 CR	XHSMCR	9/16 OH	10	S20-2758	
K 165	XHUS	9/16 OH	10	S20-5107	
K 165 CR	XHUSCR	9/16 OH	10	S20-6339	
826720C2	XHTS	9/16 OH	10	S20-3276	

SICKLE ASSEMBLIES

For All Mowers.

S35-3329



Bolted

Replaces Number	Size	Description Section / Qty	Section Number	Head Number	Order No	Price
KA 192	7'	XH US (28)	K 165	K 066A	S35-3329	
KA 1790	9'	XH US (36)	K 165	K 066A	S35-3333	
KA436DS	9'	XH US	K 165		S35-1330**	

Riveted

Replaces Number	Size	Description Section / Qty	Section Number	Head Number	Order No	Price
KA 192	7'	XH US (28)	K 165	K 066A	S35-3329	
KA 1790	9'	XH US (36)	K 165	K 066A	S35-3333	
KA1790	9'	X HTS (36)	826720C2	K066A	S35-3018*	

*Special order item - Minimum quantity may be required.

UNIVERSAL MOWER SICKLES

For All Mowers

Description	Head Number	Order No	Price
7" XH7TS Knf	Headless	S35-1038	
9" XH7TS Knf	Headless	S35-1039	

SICKLE HEADS



Replaces Number	Order No	Price
K 066A	H15-0328	
707110	H15-0429	

PITMAN - WOODS

Our pitman woods are made from highly selected and thoroughly seasoned, straight grained hickory for strength and durability. They are finished and bored BUT do not include separate straps, bolts or boxes. To be used ONLY as specified.

Replaces

Number	Size	Order No	Price
M 222184, K120	35-11/16"	P38-0535	

PLATES - GUARD / WEAR / SHOE

P44-0417



Replaces Number	Description	Application	Order No	Price
K 162	Wear Plate (Center Guard)	All Mowers	P44-0417	
K 163	Shoe Plate (Outer Guard)	All Mowers	P44-0617	

GUARDS AND BOLTS



Replaces Number	Description	Application	Order No	Price
MC 2041Z, K167	Center-Malleable	Mowers All	G81-0830	
592722R1, M805X	7/16 x 1-1/2 Bolt	613838R1 Guard, 50/Box	B55-0260	
K256	7/16 x 1-3/4 Bolt	FS65-2 Guard, 50/Box	B55-0265	

HOLD DOWN CLIPS

STANDARD CLIPS

Replaces Number	Description	Application	Order No	Price
K 183B	Cast, Lo-Arch	All Mowers (New Style)	C45-0693	

C45-0693



ADJUSTABLE CLIPS

XL2000ADJ	Cast, Lo-Arch	Most Mowers & Conditioners	C45-0006	
XH2000ADJ	Cast, Hi-Arch	Most Mowers & Conditioners	C45-0007	
XLA	Cast, Clip Arch Only, Low	Most Mowers & Conditioners	C45-0008	
RB100	Rubber Elastomer	Most Mowers & Conditioners	R36-0001	
L600ADJ	Steel, Lo-Arch, Adjustable	Most Mowers & Windrowers	C45-0040	

C45-0040

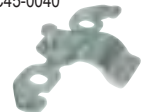

SHORT LINES

SECTIONS FOR ALL MOWERS & CONDITIONERS

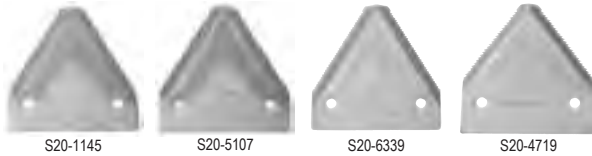

Section Number	Size	Description	Rivet Used	Pkg. Qty.	Order No	Price
0577HS	3" x 3-1/4"	XHSM	9/16" OH	10	S20-1145	
OU577HS	3" x 3-1/4"	XHUS	9/16" OH	10	S20-5107	
01188HS	3" x 3-1/4"	XHUSCR	9/16" OH	10	S20-6339	
714604	3" x 3-1/4"	XHTSCR	5/8" OH	10	S20-4719	
M333-1/2	3" x 3-1/4"	XHSM	9/16" OH	10	S20-1145	

RAKE TEETH



Replaces Number	Description	Application	Order No	Price
048ME	2 Prong Spring	Rakes 4 Bar, 4, 44, 45G	T16-0380	
400033, 0633ME, 782ME	1 Prong Spring	Rakes 49, 400, 402, 403	T16-0370	
400341	2 Prong Spring	Rake 404 Wheel Type	T16-0368	

SICKLE ASSEMBLIES - RIVETED



Replaces Number	Size	Description	Application	Section Number	Head Number	Order No	Price
OU286HSA	7'	XH US (28)	Mowers 10, 20, 30, 40, 41, 250, 251, 252, 253, 254, 255	OU577HS	045H	S35-3536	
290627S	9'	XH US (35)	Mower/Cond. 290	OU577HS	None	S35-3620	
101987C91	7'	XH US (28)	Mower/Cond. 507, 5107	OU577HS	824594C91	S35-3293	
101988C91	9'	XH US (36)	509, 5109	OU577HS	824594C91	S35-3292	
462381R93	7'	XH SM (28) Tiger Shark™	Mowers 521 & 522	826724C2	56692C91	S35-3668 S35-2500	
462380R93	7'	XH US (28) Tiger Shark™		826724C2	56692C91	S35-3667 S35-2500	
463182R93	9'	XH SM (36)		826724C2	56692C91	S35-3672	
463159R93	9'	XH US (36) Tiger Shark™		826724C2	56692C91	S35-3669 S35-2512	

SICKLE HEADS



Replaces Number	Application	Order No	Price
045H	Mowers 10, 20, 30, 40	H15-0253	
ZA502562	M/C 512, 514	H15-0292	
462378R11	Mowers 521, 522	H15-0281	

SICKLE ASSEMBLIES - BOLTED

Replaces Number	Size	Description	Application	Section Number	Head Number	Order No	Price
BN502825	12-1/4'	XH US CR (48)	Mower/Cond. 512	O1188HS	ZA502562	S35-2293	
BN502826	14-1/4'	XH US CR (56)	Mower/Cond. 514	O1188HS	ZA502562	S35-2294	

PITMAN WOOD

Fits all Mowers except 253.
35-7/8"

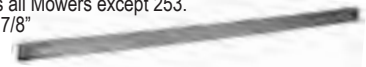

Order No. P38-0550

GUARDS - FORGED AND MALLEABLE AND HOLD DOWN CLIP

Replaces Number	Description	Application	Order No	Price
DM 700, 25314	Center-Malleable	Most Mowers	G81-0803	
MC 2041Z	Center-Malleable	Mowers 521 & 522	G81-0830	
FS 65-2, HA270	Two Prong-Forged		G81-0035	
FS 66-2	Two Prong-Forged		G81-0191	
HA240A, 714611				
FS66-DH	Two Prong-Double	Combine Uni Harvester	G81-0042	
HA245DH	Heat Treat	Header No. 815 thru 820		
FS72-2, HA280, 290835	Two Prong-Forged	290 Mower Conditioner	G81-0065	
FC90-2, HA240A, 714611	Two Prong-Forged	71, 713, 715 Combine	G81-0192	
HA245				



OWATONNA/PRAIRIE STAR

SECTIONS - 3" x 3-1/4"

Sections are sold in packages of 10.



S20-4013



S20-3325



S20-4268



S20-5107



S20-6339



S20-4464

Replaces Number	Description	Application	Section Design	Rivet Used	Order No	Price
340-16457	XHTSCR	Windrowers 180, 196, 197, 200, 206,	B	1/2 OH	S20-4013	
SS340-32015	XH7TS	262, 265, 270, 275, 280, 282, 281, 285	B+	9/16 OH	S20-3325	
SS340-32015CR	XH7TSCR		B+	9/16 OH	S20-4268	
340-32049	XHUS		B-	9/16 OH	S20-5107	
340-32049 CR	XHUSCR		B-	9/16 OH	S20-6339	
TT 049254	XHTTCR		R	9/16 OH	S20-4464	
340-32041	XHTS	X-HI Shoulder 1-5/8, Fits All Above		9/16 OH	S20-3148	

GUARDS

Raised Trash Bar. Fits Windrowers and Mower Conditioners. Replaces OEM 110-32327, 110-32342, FS92-2.



Order No. G81-0140

GUARD BOLTS

No. 3 Head (N/C Black) Gr. 5 Hardened (With Nuts)



Carriage Head (Plated) Gr. 5 Hardened (With Flange Lock Nuts)



Size	Application (Guard No.)	Replaces OEM Bolt No.	Pkg. Qty.	Order No	Price
1/2" x 1-1/2"	110-10657	030-10659, 030-10642	50	B55-0295	

Size	Application (Guard No.)	Replaces OEM Bolt No.	Pkg. Qty.	Order No	Price
7/16" x 2"	110-10657	030-31517	25	B55-0200	

SICKLE ASSEMBLIES

Less Head



S35-2262

Replaces Number	Size	Description/ # Sections	Section Number	Application	Riveted Order No	Riveted Price	Bolted Order No	Bolted Price
340-32019	12'	XH TS (49)	340-32015	Windrowers 208, 216, 229, 235, 255,	S35-3742		S35-1161	
340-32020	14'	XH TS (57)	340-32015	260, 265, 270, 275, 280, 282, 285, 281,	S35-3741		S35-1162	
340-32021S	16'	XH TS (65)	340-32015	800, 900, 2650, 2240, 2270	S35-3744		S35-1165	
340-32056	9'	XH US (34)	340-32049	M/C 180, 196, 197, 200, 206, 207, 208, 216, 217	S35-3681			
340-32046S	14'	XH TS (57)	340-32041	260D, 270D, 275, 280, 281, 262, 265	S35-3150			
340-32047S	16'	XH TS (65)	340-32041		S35-3151			
340-32048S	20'	XH TS (81)	340-32041		S35-3152			
33704	18'	XH7TSCR	SS34390CR	Windrowers & Drapers Made By MacDon			S35-2262	
43074	21'	XH7TSCR	SS34390CR				S35-2253	
43076	4' Ext., use w/S35-2253	XH7TSCR	SS34390CR				S35-2254	
43077	9' Ext., use w/S35-2253	XH7TSCR	SS34390CR				S35-2255	

ROWSE

SECTIONS

Fits All Mowers. 3" x 3-1/4"



S20-5107



S20-1145

Replaces Number	Description	Rivet Used	Pkg. Qty.	Order No	Price
M22831, 29875	XH US	9/16 OH	10	S20-5107	
M3331/2	XH SM	9/16 OH	10	S20-1145	

GUARDS - FORGED



G81-0184



G81-0144



G81-0035

Replaces Number	Description	Application	Replaces OEM No	Order No	Price
FS93-2	Two Prong	Current Mowers	219190	G81-0184	
HA216	Double Heat Treat	Current Mowers	219190	G81-0144	
FS93DH					
HA216DH					
FS65-2	Two Prong	Older Mowers	613838R1	G81-0035	
HA270					

SICKLE ASSEMBLIES



S35-3668

Replaces Number	Size	Description/ Section No.	Application	Section Number	Head Number	Riveted Order No	Riveted Price	Bolted Order No	Bolted Price
228435	7'	XH US (29)	Current Mowers	29875	143603	S35-3884			
228434	9'	XH US (35)	Current Mowers	29875	143603	S35-3885		S35-1704	
4BN228434		Tiger Shark™						S35-2552	
462381R91	7'	XH SM (28)	Older Mower	M3331/2	462378R11	S35-3668		S35-2500	
		Tiger Shark™						S35-1281	
462380R91,	7'	XH US (28)	Older Mower	M22831	462378R11	S35-3667		S35-2500	
BN462380R91		Tiger Shark™							
463182R91	9'	XH SM (35)	Older Mower	M3331/2	462378R11	S35-3672			
463159R91,	9'	XH US (35)	Older Mower	M22831	462378R11	S35-3669		S35-1714	
BN463159R91		Tiger Shark™						S35-2512	

SICKLE HEADS

Replaces Number	Application	Order No	Price
143603	Current Mowers	H15-0208	
462378R11	Older Mowers	H15-0281	

DUMP RAKE TEETH

Replaces RC216U(7/16)



Order No	Price
T16-0060	

SHORT LINES

SCHUMACHER

SECTIONS FOR EASY CUT SYSTEM

S20-4498



Description	OEM#	Order No	Price
HSRKCR	CAN BE USED TO REPLACE OEM	S20-8498	
Tiger Shark™	NUMBERS LISTED BELOW		
XH7TSCR	420-100-058, 26208CR	S20-4498	
XH7TS	420-100-058	S20-3513	

BOLTS & NUTS FOR EASY CUT SYSTEM

C83-0500



B55-0075D



B55-0079D



Replaces No.	Description	Pkg. Qty	Order No	Price
01106001, 61713	Section Flange Nut	20/bb	N83-0075D	
420100012, 61711	Section Bolt & Nut M6-1.0x16	50/bb	B55-0075D	
011006018, 61521	Head Bolt Kit. (6) M6-1.0x18	9/bb	B55-0079D	
01106001, 62758	& (3) M6-10.x28 Schumacher Splice Kit		C83-0500	

SPLICED SICKLES FOR EASY CUT SYSTEMS

Sickles Are Headless
• Super 7® Section
• Chrome



Section Type	Size	No. Of Sections	Order No	Price
XH7TSCR	20	82	S35-2520	
XH7TSCR	25	102	S35-2525	
XH7TSCR	30	122	S35-2531	
XH7TSCR	35	142	S35-2535	
XH7TSCR	36	146	S35-2544	
XH7TSCR	40	146	S35-2546	

GUARDS

Replaces Number	Description	Application	Order No	Price
10616.10, 16500.10	12mm Guard	AGCO-Gleaner Series 3, 300-8200; Challenger, JD Quik-Tack, 200, 900, 900 R&F, Honey Bee, New Holland, 88C, 92C, 94C	G81-0201	
10618.10, 16502.10	17mm Guard	Case IH 820, 1020	G81-0202	

TRIUMPH

SECTIONS - 3" x 3-1/4"

Fits All Mowers

S20-5246

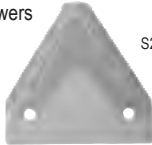

S20-1142



S20-4286



Replaces Number	Description	Application	Rivet Used	Pkg. Qty.	Order No	Price
646	XH US	All Mowers	9/16 OH	10	S20-5246	
1227	XH SM		9/16 OH	10	S20-1142	
SSBKE45996	XH7TS		9/16 OH	10	S20-3407	
SSE45996	XH7TS CR		9/16 OH	10	S20-4286	

SICKLE HEAD

Fits Mowers and Hydro-Clipper

Replaces Number	Order No	Price
1874	H15-0288	

WEAR PLATES

Fits All Mowers

Replaces Number	Order No	Price
FLW 70, 1317	P44-0412	

PITMAN STRAPS & LATCH FORK

Replaces Number	Description	Order No	Price
1911 (MA 1577)	Pitman Strap	S78-0834	
1912 (M 1578)	Pitman Strap	S78-0835	
1915 (MC 1579A)	Latch Fork Assembly	L02-0723	

GUARD BOLTS - 7/16"

50/Box

B55-0260



Replaces Number	Description	Order No	Price
464	1-1/2" #3	B55-0260	
465	1-5/8" #3	B55-0265	

SICKLE ASSEMBLIES - 6'

Fits Mowers and Hydro-Clipper

S35-3062



Replaces Number	Description	Section	Head	Riveted	Riveted	Bolted	Bolted
Number	Section # Used	Number	Number	Order No	Price	Order No	Price
1876	XH US (24)	M646	1874	S35-3062			
SS1876BN	XH7TS (24)	SSBKE45996	1874			S35-1077	
BN1876CRSS	XH7TSCR (24)	SSE45996	1874			S35-2924*	

* Note: Special Order Item. Minimum quantities may be required

HOLD DOWN CLIPS

Replaces Number	Description	Application	Order No	Price
L600ADJ	Lo-Arch, Adjustable, Stamped Steel	Most Mowers	C45-0040	

VERMEER

BALER BEARINGS & SPROCKET

H4052001



S62-0807



OEM#	Bore Size/Shape	Description	Fits	Order No	Price
1718-001	1" Cylindrical w/collar	Rubber Idler Roller	I, K, L, XL Series	H1718001	
4051-001	1-1/2" Cylindrical w/collar	Hay Saver Wheels and Net Wrap Idler	G, H, I, J, K, L, XL, M Rebel Series	H4051001	
215-003, 510502547	1-1/2" Cylindrical w/collar	Idler & Upper Roller	F, G, H, I, J, K, L, XL, M, Rebel Series	H215003	
4047-001	1-1/4" Spherical w/collar	Pick Up Drive, Power Feed Rollers, Belt Tightener Assembly	I, K, L, XL, M, Rebel Series	H4047001	
4052-001, 502289-001	1-1/4" Spherical w/collar	Cross Drive Shaft, Pick up, Lower Drive Roller	I, J, K, L, XL, M, Rebel Series	H4052001	
212-001	1-1/2" Spherical w/collar	Starter, Drive, Idler, Lower Drum Rollers, Pick up, Cross Drive Shaft	C, F, G, H, I, J, K, L, XL, Rebel Series	H212001	
110457-003	1-15/16" Spherical 4 Bolt	Upper Belt Drive Rollers	K, L, XL Series	H110457003	
1813-001	60 Chain,.5" Bore Size.	Idler Sprocket. 3/4 Pitch. 15 Tooth	C, D, E, F, G, H, I, J, K, L, XL, Rebel Series	S62-0807	

SICKLE ASSEMBLIES - BOLTED

Fits White 6400 Windrower with Draper Header
Headless



Replaces Number	Section Type	Size	Section Number	Order No	Price
33704	XH7TSCR	18'	SS34390CR	S35-2262	
43074	XH7TSCR	21'	SS34390CR	S35-2253	
43076	XH7TSCR	4' Ext., use w/S35-2253	SS34390CR	S35-2254	
43077	XH7TSCR	9' Ext., use w/S35-2253	SS34390CR	S35-2255	

SICKLES - COMBINES WITH KWIK CUT SYSTEM

Headless

Section Type	Size	Description	Order No	Price
XHTSCR	13' & 15'	Universal 2-point Tiger Jaw sickle	S35-2154	
XHTSCR	18' & 20'	Universal 2-point Tiger Jaw sickle	S35-2156	
XHTSCR	4'	4' Extension, use with S35-2156	S35-2271	

FORGED GUARDS

OEM Number	Replaces Number	Description	Application	Order No	Price
895744 L	FS 73-2, HA235	Two Prong	Windrowers 501, 502, 503	G81-0070	
31-2749417	FC 89-2, HA231	Two Prong	Combine Floating Bars (w/Groove)	G81-0125	
9510220	BU240, HA240		Combines Rigid Bars	G81-0191	

RAKE TOOTH - 1-PRONG

Fits No. 5 Rake. Replaces 64562.
Mfr: Minnesota.

T16-0370

DRIVE ADAPTER BAR FOR KWIK CUT

H15-0219



G81-0188

REEL TINES

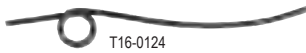

T16-0124

Number	Replaces Application	Qty.	Pkg. Order No	Price
N66A	Front Side of Wood Bats	100	T16-0183	
N67A	Rear Side of Tear Drop Bat	100	T16-0767	
1127204	1 Prong, Steel. Used on Hume Reels.	Each	T16-0124	
782551, 1989438C1, AH136689, AH153175	2 pc. M/L Reel Tine w/clamps	100	T16-0720	
782226, 1989438C1, AH136689, AH153175	2 pc. M/L Reel Tine w/clamps	10/Bag	T16-0715	
HA100MLT	M/L Reel Tine Only, Less Clamps; For T16-0720 & T16-0715	100/Box	T16-0725	
HA20SC	Replacement Screw for T16-0715, T16-0720	20/BB	B55-0096D	



Plastic Tine Only

2-Piece Plastic Reel Tine

PLASTIC BEARINGS & HARDWARE FOR PIPE REEL KITS

Outside Tine Bracket. Use with T16-0730 to replace LH or RH original steel reel end fingers. Fits Herschel Reel Conversion Kits. Sold individually.

Order No. B65-0120

Outside Reel Tine for LH or RH applications on Herschel Reel Conversion Kits. Sold 12/Bag. Sold 6/Box.

Order No. T16-0730

Plastic Bearing Kit. Includes 6 bases, 6 caps, 6 U-bolts, & 12 nuts. Fits reels with wood bats used on White Heavy Duty Platforms.



Order No. B15-0915

B	
Bale Spears	73
Baler Shear Bolts	71
Bolts, Section	71
Bolt-N-Clip Kit	71
E	
End Sections	72
G	
Grass Board	72
H	
Hammer Rivet Tool	71
Hammer Rivets	71
Hold Down Clips	73
P	
Pitman Woods	72
R	
Rake Wheels	73
Rivet Tool	72
Rivets	71
S	
Sections, End	72
Sickles	72
W	
Wear Plates	72

SECTION BOLTS

- Quick and easy section changes are possible with bolts.
- No more cutting, chiseling, or grinding. Simply unbolt the section, replace and tighten bolts.
- Bolts will not turn in Knife Back and are reusable. They will last thru the life of several sections.
- Bolts may be replaced easily if accidentally damaged or broken.
- No special tools are needed to change sections, only 7/16" wrench or socket.
- Bolt and nuts hold better than rivets and they have a greater "clamp load" than rivets.
- Special lock nuts will not vibrate loose.
- Torque to 8-10 foot pounds.

Description	Application	Pkg. Qty.	Mstr. Ctn.	Order No	Price
Section Bolt w/nut	Universal - Repl. 9/16" & 5/8" OH Rivets	50	300	B55-0065D	
Head Bolt w/nut	Universal - Repl.s 1" & 1 1/16" OH Rivets	15	90	B55-0085D	
Head Bolt w/nut	Universal - Repl. 1 1/4" OH Rivets	12	72	B55-0095D	
Section Bolt w/nut	Universal - Bolts for 10' Sickles w/Head Bolts (80 -B55-0065D,5-B55-0085D,5-B55-0095D)	90	Each	B55-0500D	
Nut	Universal - Used on all the above bolts	20	120	N83-0289D	
Low Profile Nut	Overlap Area on Dbl. Drives & Case/IH 1020 1-1/2" Systems	20	120	N83-0295D	
5/8" Section Bolt w/nuts 90° CSK, Oval Shoulder	Versatile, Windrower 4400, 2400, 2800	20	120	B55-0955D	
7/8" Head Bolt w/nuts; 90° CSK, Oval Shoulder	Versatile, Windrower 4400, 2400, 2800	10	60	B55-0975D	
5/8" Ribbed Bolts & Nuts; 60° CSK	Ford & Versatile	50	300	B55-0970D	
1" Ribbed Bolts & Nuts; 60° CSK	Versatile	25	150	B55-0971D	
1/2" Overlap Bolt w/low profile nut	Double Drive Sickles	10	60	B55-0059D	
9/16" Overlap Bolt	Versatile,Bolted Countersunk	20	120	B55-0056D	
Full Height Nut, 60° CSK					
5/8" 60° CSK Bolt w/Nut	Versatile, Bolted Countersunk	20	120	B55-0057D	
1" Head Bolt & Nuts, 60° CSK	Versatile Head Bolt/MacDon Splices	10	60	B55-0058D	



BALER SHEARBOLTS

Designed to meet OEM specifications. All bolts are grade 5, plain finish except where noted. Pkg. of 10 bolts with nuts.

Description	Order No.	Price
John Deere 1/4"-20 x 2-1/4" Hex Head.	B55-0550D	
New Holland 5/16-18 x 2" Hex Head.	B55-0551D	
1/4"-20 x 1-1/2" Hex Head.	B55-0552D	



BOLT-N-CLIP KIT

For Conversion of Most Sickle Bars from Rivets to Bolt-On Sections. Includes Section Bolts & Lock Nuts, Special Hi-Clearance Hold Down Clips for Over Lock Nuts & Hi-Arch Clip for Over Drive Head. Replaces BAS800.

Size	Order No	Price
10' Bar	B55-0629	



RIVETS

Assortments, Display Pack

Size / No. in Pkg.	Description	Application	Qty. Pkg.	Qty. Mstr.	Order No	Price
5/8" # 5-1/2 (56)	OH Rivets Asst.	7' Heavy Mower Sections & Knife Heads	Asst.	6	R36-0523D	
1" # 5-1/2 (10)	Zinc Plated					
5/8" # 5-1/2 (72)	OH Rivets Asst.	New Holland 9' Haybines, John Deere, Inter. Harvester & Most	Asst.	6	R36-0524D	
1" # 5-1/2 (5)	Zinc Plated					
1-1/4" # 5-1/2 (5)		Other Mower Conditioners				
1/4" x 5/8" OH	OH Rivets Zinc Plt.	For Sections H21527H, P49650	1#	6#	R36-0480D	
1/2" OH	OH Rivets Zinc Plt.	Regular Gauge Sections	1#	6#	R36-0521D	
9/16" OH	OH Rivets Zinc Plt.	Heavy Gauge Sections	1#	6#	R36-0461D	
5/8" OH	OH Rivets Zinc Plt.	Heavy Gauge Sections	1#	6#	R36-0462D	
15/16" OH	OH Rivets Zinc Plt.	Head Rivet	1/2#	3#	R36-0522D	
1" OH	OH Rivets Zinc Plt.	Head Rivet	1/2#	3#	R36-0465D	
1-1/4" OH	OH Rivets Zinc Plt.	Head Rivet	1/2#	3#	R36-0467D	
1/2" CS	CS Rivets Zinc Plt.	Section Rivet	1#	6#	R36-0464D	
5/8" CS	CS Rivets Zinc Plt.	Section Rivet	1#	6#	R36-0463D	
1" CS	CS Rivets Zinc Plt.	Head Rivet	1/2#	3#	R36-0466D	
1-1/4" CS	CS Rivets Zinc Plt.	Guard Plate Rivet	1/2#	3#	R36-0468D	
9/16" (1 lb./BB)	CS Rivets Zinc Plt.	Primarily used on Rice Cutterbars	1#	6#	R36-0469D	



R36-0462D

R36-0467D

HAMMER RIVETS & HAMMER RIVET TOOL

Replaces Number	Size	Description	Application	Pkg. Qty.	Order No	Price
SPK6	3/16" x 5/16"	Small Head	Case-IH 1020	50/BB	R36-0652	
SPK5	1/4" x 3/8"	Large Head	JD 900 Series	50/BB	R36-0653	
SPK7	1/4" x 5/16"	Large Head	JD 900Series	20/BB	R36-0654	
SPK9	3/16" x 5/16"	Large Head	All models except JD 900 Case-IH 1020	50/BB	R36-0655	

Hammer Rivet Tool For Drive Rivets

T55-0812



UNIVERSAL END SECTIONS

HERSCHEL "End Sections" are made of heat-treated steel for rugged use. They are punched with an oblong hole to virtually fit any standard cutterbar mower in use today. To install our "End Section", simply take off the last section on the shoe end of your sickle assembly and replace it with an "End Section". The change-over takes only a couple of minutes to complete and you will notice a big difference in time saved from unclogging your mower. We recommend using R36-0523D oval head rivet or TJ55BN Bolt.

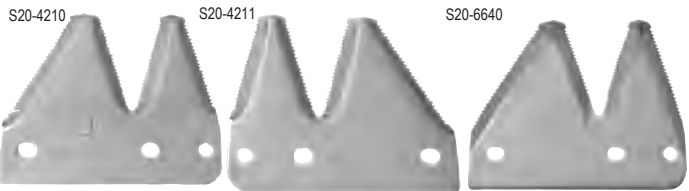

For all mowers, mower conditioners & windrowers w/standard cutterbar.

Replaces Number	Description	Order No	Price
3TS-7	XH7TSCR (RH) 10/Box	S20-4403	
3TS-7-SP	XH7TSCR (RH) 2/SP	S20-4403D	
3TS-7	Tiger Shark™ (RH) 10/Box	S20-8403	
3TS-7-SP	Tiger Shark™ (RH) 2/SP	S20-8403D	
3TS-7-LH	XH7TSCR (LH) 10/Box	S20-4445	
3TS-7-LH-SP	XH7TSCR (LH) 2/SP	S20-4445D	
3TS-7-LH	Tiger Shark™ (LH) 10/Box	S20-8445	

Replaces Number	Description	Order No	Price
3TS-7-LH-SP	Tiger Shark™ (RH) 2/SP	S20-8445D	
3 TS	XHTS CR (RH) 10/Box	S20-4210	
3 TS-SP	XHTS CR (RH) 2/SP	S20-4210D	
3TSLH	XHTSCR (LH) 10/Box	S20-4211	
3TSLH-SP	XHTSCR (LH) 2/SP	S20-4211D	
2 US	XHUSCR (RH) 10/Box	S20-6640	
2US	XHUSCR (RH) 2/SP	S20-6640D	

SECTION TOOLS

COMBINATION RIVET VISE

Combination rivet punch and riveter. Changes sections in the field without removing the knife.



Replaces Number	Description	Order No	Price
R-TOW100TJ	Rivet Tool Complete	T55-0584	

PARTS FOR RIVET TOOLS

R5002	Punch (5/16" Dia.)	T55-0590
-------	--------------------	----------

KNOCK-OUT REPAIR KIT

Includes knockout screw assembly, roll pin, knockout punch and steel ball.

Order No. T55-0585

RIVET REPAIR KIT

Includes rivet setting screw, spring, cup & retainer ring.

Order No. T55-0586



STEEL GRASS BOARD

The "Clean Sweep" grass board steel rods are adjustable according to the cutting conditions. Will not dig into the ground on turns nor while backing up. For Mowers

Order No. B52-0615



STRAW CHOPPER AND TUB GRINDER SECTIONS



Description	Application	Order No	Price
XH US - (2) 1/4" Holes (2-1/16" ctr. to ctr.) 10/Box Hardfaced, 5/16" Holes (2-1/16" ctr. to ctr.) 10/Box	Most "Barn Straw Choppers" Rotomix Grinders	S20-5169 S20-1275	

WEAR PLATES

The "FLW" Series Wear Plate is a full length cutterbar plate with an unbroken surface. The "W 50" Wear Plate is 5-7/8" long and can be used to replace any standard wear plate.



Replaces Number	Size	Description	Application	Order No	Price
W 50	5-7/8"	Slotted Holes w/3" Spacing	Mowers, Swathers & Combines	P44-0591	
FLW 24	2'	24" w/1-1/2" Spacing, Heat Treated	Tiger Jaws 2000 & Original	P44-0200	
FLW 70	7'	Full Length	Mowers	P44-0412	
FLW 90	9'	Full Length	Mowers	P44-0413	

UNIVERSAL BOLTED SICKLES - HEADLESS

Fits IH Mowers & 990, 1190 M/C; Ford 505, 535, 536, 537 Mowers & 538 M/C; Gehl 880, 1090, 2130, 2160 M/C; Hesston all single drive M/C and Windrowers; New Holland 450, 451, 455, 456 Mowers & 460, 461, 467, 469, 1469, 472, 477, 478, 479, 488, 489, 490, 492, 1469 M/C; New Idea 10, 20, 30, 40, 41, 521, 522 Mowers & 290 M/C; Owatonna 180, 196, 197, 200, 206, 207, 208, 216, 217, 2140, 2170 M/C.

Hole Size	Spacing	Section Type	No. Of Sections	Order No	Price
7"	2-1/16"	XH7TS	30	S35-1038	
9"	2-1/16"	XH7TS	38	S35-1039	
2"	2-1/16"	XH7TS	9	S35-1040	

Fits AC 7, 80; John Deere 5, 8, 9, 11, 37, 38, 39, 47, 50, 250, 350, 450, 3700 Mowers, 480, 483, 485, 1207, 1209, 1217, 1219 M/C; Ford 50, 51, 62, 63, 64, 65, 66, 175, 176, 234, 257, 258, 259, 260, 501, 502, 515, 14-3, 14-4, 14-15, 14-16, 14-94, 95, 96, 97, 14-280, 1, 2, 3

Hole Size	Spacing	Section Type	No. Of Sections	Order No	Price
7"	2"	XHUS	30	S35-1035	
9"	2"	XHUS	38	S35-1036	

Use All With Splice Kit C83-0755

PITMAN WOODS

Our universal pitman wood is designed in such a manner, it can be shaped by the purchaser to fit almost any pitman application. 37-1/2" x 1-7/16" x 1-1/8"

Order No. P38-0560

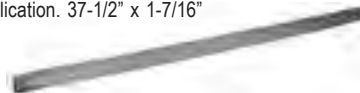

BALE COUNTER

Fits most balers. Reads up to 99,999. 4-Hole Mounting Plate. Push Button Reset Adjustable Side Arm

Order No. T55-0002 Price



HOLD DOWN CLIPS NON-ADJUSTABLE

No matter what type of cutting condition you might encounter, we have a universal knife clip for you. The clips listed below are designed to adapt to virtually any standard cutter bar on mowers, swathers, windrowers, and even combines.

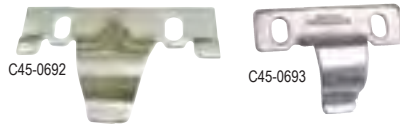

Description	Application	Order No	Price
Steel, Lo-Arch	Bolted Sickles	C45-0692	
Steel, Lo-Arch	Bolted Sickles, 2/PK	C45-0692D	
Steel, Hi-Arch	Bolted Sickles with Head Clearance	C45-0693	
Steel, Hi-Arch	Bolted Sickles with Head Clearance, 1/PK	C45-0693D	

HOLD DOWN CLIPS ADJUSTABLE



Description	Application	Order No	Price
Cast, Lo-Arch	Universal, Most Hay Machines & Combines	C45-0006	
Cast, Hi-Arch	Universal, Most Hay Machines & Combines	C45-0007	
Cast, Low Clip Arch Only,	For C45-0001 and C46-0006	C45-0008	
Rubber Elastomer	For C45-0006 & C45-0007	R36-0001	
Steel, Lo-Arch	Universal, Most Hay Machines & Combines	C45-0040	
Steel, Lo-Arch	Universal, Most Hay Machines & Combines pkgd. in display box of 24	C45-0040X	

BALE SPEARS

Bolt On Spears

Nut included. Order Sleeve Separately.



Description	Length	Capacity	Order No	Price
Threaded Standard Duty	32"	2500 lbs	BS39WN	
Threaded Standard Duty	43"	2500 lbs	BS43WN	
Threaded Standard Duty	49"	2500 lbs	BS49WN	
Threaded Heavy Duty	32"	3500 lbs	BS39WNHD	
Threaded Heavy Duty	43"	3500 lbs	BS43WNHD	
Threaded Heavy Duty	49"	3500 lbs	BS49WNHD	

Pin On Spears Order Bushing/Sleeve Separately.



Description	Length	Capacity	Order No	Price
Cross Bolt Standard Duty	43"	2500 lbs	BS43CB	
Cross Bolt Standard Duty	49"	2500 lbs	BS49CB	

Hardware

Description	Length	Order No	Price
Nut - For All Bolt On Spears Above	1.18" dia.	BSNUT	
Sleeve Standard Duty	4.72"	BSSLEEVE	
Sleeve Heavy Duty	5.71"	BSSLEEVEHD	
Bushing For Pin On	5.71"	BSSLEEVECB	



RAKE WHEELS AND HUB

Heavy Duty, .275. Fits Sitrex, Case, H&S, M&W, New Holland, Westward & Others. Overall diameter: 56"

Description	Order No	Price
Right Hand	W16-0801	
Left Hand	W16-0802	
Replacement Tine Part Number T16-0815D.		

Heavy Duty, .276" (7mm). Fits Tonutti/National/Walton, John Deere/Frontier, Vermeer, Kuhn, Miller Pro/Arts Way, Gehl. Replacement Tine: T16-0489.

Description	Order No	Price
Right Hand. P20BG003	W16-0805	
Left Hand. P20BG004	W16-0806	

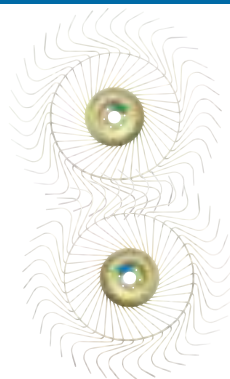

.295". Fits Sitrex, H&S, New Holland & Others. Overall diameter: 60". Black.

Description	Order No	Price
Right Hand	W16-0808	
Left Hand	W16-0807	
Replacement Tine Part Number T16-0815D.		

HUB ASSEMBLY

With bearing for all wheels listed at left. Pilot: 3.21". Bolt circle: 5.12". 13mm bolt required

Order No.	Price
H16-1000	

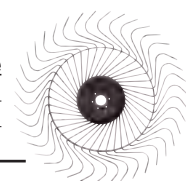

UNIVERSAL

	F	
Flail Knives		76
Finish Mower Parts		75
	R	
Rotary Tail Wheels		75

ROTARY MOWER TAIL WHEELS

OEM Quality. Fits Most major Brands
Including: Bush Hog, John Deere, LandPride, Rhino and More.

• Forged Yokes for added strength. • All parts zinc or powder coated.

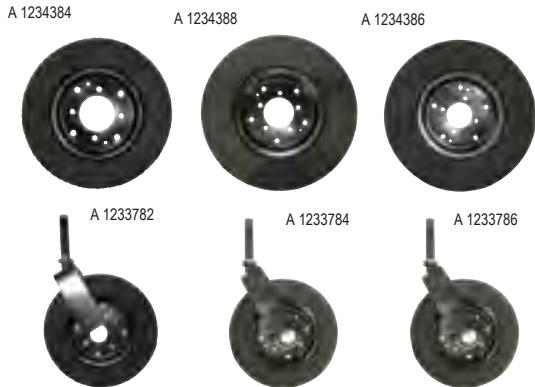

Description	Order No.	Price
4x8 4 Bolt Rim w/15 x 4 Laminated Tire	A 1234384	
6x9 4 Bolt Rim w/21 x 5.5 Laminated Tire	A 1234386	
6x9 5 Bolt Rim w/21 x 5.5 Laminated Tire	A 1234388	
Complete Tail Wheel Assembly. 4" x 8". 1-1/4"	A 1233782	
Diameter Yoke w/Cast Hub & Bushings		
Complete Tail Wheel Assembly. 4" x 8". 1-1/4"	A 1233784	
Diameter Yoke w/Cast Hub & Bearings		
Complete Tail Wheel Assembly. 6" x 9". 1-1/2"	A 1233786	
Diameter Yoke w/Cast Hub & Bearings		

ROTARY MOWER WHEEL PARTS

OEM Quality. Fits Most major Brands Including: Bush Hog, John Deere, LandPride, Rhino and More. All parts zinc or powder coated.



Type	Description	Used On	Order No.	Price
Axle Bolt	3/4 x 8" Clipped Head Axle Bolt w/Castle Nut	A 1233782, A 1233784 & A 1233786	A 1234370	
Bushing	3/4". For cast and fabricated hubs		A 1234377	
Bushing	1". For cast and fabricated hubs		A 1234379	
Hub	Cast Hub w/1" I.D. Bushings		A 1234371	
Hub	Cast Hub w/3/4" I.D. Bushings	A 1233782	A 1234372	
Hub	Cast Hub w/3/4" Bearings & Weed Guards. 510	A 1233784 & A 1233786	A 1234373	
Hub	Fabricated Hub w/1" I.D. Bushings		A 1234374	
Hub	Fabricated Hub w/3/4" I.D. Bushings.		A 1234375	
Rebuild Kit	Includes 2 caps, 2 bearing/races, 2 step bushings and 2 seals		A 1234385	
Yoke	1-1/2" Yoke diameter. For 3/4" axles		A 1234382	
Yoke	1-1/4" Yoke diameter. For 3/4" axles		A 1234383	

All Hubs Include Lug Bolts.

FINISH MOWER PARTS

OEM Quality. Fits Most Major Brands.

Description	Order No.	Price
3.25" x 10" Finish Mower Assembly 1" Diameter Yoke. 8.5" Long	A 1233781	
Solid Molded Finish Mower Tire w/rim	A 1234378	



NEEDLE BEARING
3/4" I.D. bearing for finish mower wheel.

Order No.	Price
A 1234380	



5 PC. FINISH MOWER ASSEMBLY SPACERS
Includes (4) 1" and (1) 1/2" spacers.

Order No.	Price
A 1234381	



3 PC. STEP DOWN BUSHING
3/4" x 1/2". Includes 2 bushings and 1 sleeve.

Order No.	Price
A 1234369	



ROTARY/FLAIL

ALLOWAY - 2" WIDE, 5/8" HOLE. 8-1/4" LENGTH. 1/4" THICK

Replaces Number	Description	Order No.	Price
505-3-0001	Side Knife	HA50530001	
505-3-0008	D-Ring	HA65142	
505-3-0014	U-Bar	HA65227	
505-3-0445			

BALZER - .635" HOLE. 6.625" LENGTH. 1/4" THICK. 2" WIDE.

Replaces Number	Description	Order No.	Price
12357, 11040039	Side Knife, 2" Wide	HA65143	
12356	D-Ring	HA65142	
12355	Pivot Bracket	HA65141	
12297	Cup Knife, 2-1/2" Wide	HA16940	
12295	Square Ring	HA65144	
12296	U-Bar	HA65227	

**BRENT - 6-1/4" LENGTH ALONG BACSIDE CURVE. 1/4" THICK
13/16" HOLE. 5" LONG. 2-1/2" WIDE.**

Replaces Number	Description	Order No.	Price
9001192	Side Knife, 2-1/2" Wide	HAE48308	
9001191	D-Ring	HAE48307	
5841006	U-Bar	HAE48305	

BRILLION - 11/16" HOLE. 5-1/4" LENGTH.

Replaces Number	Description	Order No.	Price
5D53	Side Knife, 2" Wide	HA4725130273	
5D52	D-Ring	HAE48307	

BUFFALO - .635" HOLE. 6.625" LENGTH.

Replaces Number	Description	Order No.	Price
11040039	Side Knife, 2" Wide	HA65143	
18020019	D-Ring	HA65142	
02070278	Pivot Bracket	HA65141	
11040041	Cup Knife, 2-1/2" Wide	HA16940	
18022020	Square Ring	HA65144	
08020007	U-Bar	HA65227	

BUSH HOG - 11/16" HOLE. 5-1/4" LENGTH.

Replaces Number	Description	Order No.	Price
4725130273	Side Knife, 2" Wide	HA4725130273	
4725130272	D-Ring	HAE48307	

Note: Also fits Long, Owattonna and Stan Hoist Applications

DANDL, BEFCO, REARS

Replaces Number	Description	Order No.	Price
S2042	Cup Knife	HA2042*	
40			
FL920			

FLORY

Replaces Number	Description	Order No.	Price
MR6002	D-Ring, 7/16" Dia.	HAE31903	
S2042, 6022709	Cup Knife	HA2042	

HINIKER/FOX-BRADY - .635" HOLE. 6.625" LENGTH. 2" WIDE.

Replaces Number	Description	Order No.	Price
65143	Side Knife, 2" Wide	HA65143	
65142	D-Ring	HA65142	
65141	Pivot Bracket	HA65141	
65317	Pivot Adapter	HA65317	
16940	Cup Knife, 2-1/2" Wide	HA16940	
65144	Square Ring	HA65144	
65227	U-Bar	HA65227	

Note: Also fits some Case, Hiniker, Massey, and Schultz applications.

JOHN DEERE



Replaces Number	Description	Order No.	Price
E48308	Side Knife, 2-1/2" W	HAE48308	
E48308, P58586	HF Coating on Back	HAE48308H	
E48307	D-Ring	HAE48307	
E48305	U-Bar	HAE48305	
E31903	D-Ring, 7/16" Diam.	HAE31903	
P66945, E31900	Cup Knife	HA2042	

LOFTNESS

Replaces Number	Description	Order No.	Price
8023, S330050V	Side Knife, 2-1/2" Wide	HAE48308	
3007, S330070V	D-Ring	HAE48307	
3003, S330060V	U-Bar	HA3003	

RHINO

Replaces Number	Description	Order No.	Price
ORC15	Cup Knife	HA2042	

VRISIMO

Replaces Number	Description	Order No.	Price
CD2135	D-Ring, 7/16" Diam.	HAE31903	
CD2110	Cup Knife	HA2042	

	B	
Bolts.....		88
	F	
Forged Guards		78 - 87
	G	
Guard Bolts.....		88
	M	
Malleable Guards		88

HA200A (G81-0231)



OEM	OEM PN#	Buchanan PN	Order No.	Price
Case IH	700707147	BU200A	G81-0231	
Hesston	700716292	BU200A		

Fits **Case-IH** Mower Conditioners – 8320, 8330, 8340, 8350, 8360, 8370, 8380, SC412, SC414, SC416. Windrowers – 8210, 8220, 8230, 8240, 8830, 8840. **Hesston** Mower Conditioners – 1110, 1120, 1130, 1150, 1160, 1170,

Weight: 1.69 lb (766.57 g)

HA206 (G81-0140)



OEM	OEM PN#	Buchanan PN	Order No.	Price
Ford	110-32342	BU-206	G81-0140	
Gehl	110-32342	BU-206		
	110-10327	BU-206		
Owatonna	110-32327	BU-206		

Fits **Ford** Windrower – Series - 537. **Ford-NH** Mower Conditioners – Series - 536. **Gehl** Mower Conditioners – 2140, 2170, 2175, 2240, 2245, 2270, 2275; Windrowers – Series – All After 1979. **Owatonna** Mower Conditioners – Series – All After 1979.

Weight: 1.77 lb (802.86 g)

HA208DH (G81-0199)



OEM	OEM PN#	Buchanan PN	Order No.	Price
CAT	676295N	N/A	G81-0199	

Fits **Claas-Cat Challenger** Combines.

HA209 (G81-0200)



OEM	OEM PN#	Buchanan PN	Order No.	Price
CAT/Lexion	767265-1	N/A	G81-0200	

Fits **Lexion** Combines - All

Weight: 1.72 lb (780.18 g)

HA210 (G81-0183)



OEM	OEM PN#	Buchanan PN	Order No.	Price
Case IH	483500R3	BU-210	G81-0183	
Ford	BU210	BU-210		
IH		BU-210		
New Idea	H483500R3	FS 85-2		
Rowse	670600			

Fits **Case IH** Mowers – Series – 200, 230, 1000, 1100, 1200, 1300, 3110; Forage Harvesters – Series – 650, 655; Mower Conditioners – Series – 170, 175, 200, 225, 816, 990. **Ford** Mower Conditioner – 538. **International Harvester** Combines – 820, 1010, 1020. **New Idea** Mowers – 521, 522. **Rowse** mowers using IH guards.

Weight: 1.78 lb (807.39 g)

HA215DM (G81-0097)



OEM	OEM PN#	Buchanan PN	Order No.	Price
Case-IH	87560324, 87421451	NA	G81-0097	
MacDon	23064, 28013, 118344, 118484	NA		

Fits **Case-IH** 1042, 1052, 2042, 2052, 2062, 2142, 2152, 2162. **MacDon** 960, 962, 963, 972, 973, 974, D50, D60, FD70, FD75. **New Holland** All.

Weight: 1.70 lb (771.11 g)

CENTER GUARD For models above: G81-0093

HA215 (G81-0155) & HA215DH (G81-0098)



OEM	OEM PN#	Buchanan PN	Order No.	Price
Badger Northland	683994M1	BU-215A	G81-0155	
Case IH	700707147	BU-215A	G81-0098*	
	88615982	BU-215A		
Hesston	700707147	BU-215A		
	700716292	BU-215A		
MacDon	23064	BU-215A		
	28013	BU-215A		
Massey Ferguson	683476M1	BU-215A		
	683994M1	BU-215A		
New Holland	219191	BU-215A		
	858778	BU-215A		
	86521587	BU-215A		
	86553340	BU-215A		
	86615892	BU-215A		

Fits **Badger Northland** Mower Conditioners – All 1978. **Case IH** Mower Conditioners – 8230, 8330, 8340, 8350, 8360, 8370, 8380, SC412, SC414, SC416. Windrowers – 8210, 8220, 8230, 8820, 8830, HDX121, HDX122, HDC141, HDX142, HDX161, HDX162, HDX181, HDX182, SCX100, SMX9. Auger – 8840. Draper Header – 1042. **Hesston** Mower Conditioners – 1110, 1120, 1130, 1150, 1170, 1260, 1270, 1275. Headers – 8010, 8020, 8100, 8200, 8400. 2010, 2020 Headers prior to S/N CBJ02000. **MacDon** headers – 960, 962, 972. **Massey Ferguson** Mower Conditioners – Series - 665, 675, 775. **New Holland** Headers – 971, 973, 71C, 73C, 74C. Windrowers – All Mower Conditioners and Windrowers

*Double Heat Treated. Can be used in place of G81-0155.

Weight: 1.70 lb (771.11 g)

GUARDS

HA218 (G81-0184)



OEM	OEM PN#	Buchanan PN	Order No.	Price
New Holland	219190	BU-218	G81-0184	

Fits **New Holland** Mowers – All

Weight: 1.70 lb (771.11 g)

HA218DH (G81-0144)



OEM	OEM PN#	Buchanan PN	Order No.	Price
New Holland	219190	BU-218H	G81-0144	

Fits **New Holland** Mowers – All

Weight: 1.72 lb (780.18 g)

GUARDS

HA220 (G81-0185)



OEM	OEM PN#	Buchanan PN	Order No.	Price
Gehl	072057	BU-220	G81-0185	
John Deere	E48093	BU-220		
	E52667	BU-220		
	E82559	BU-220		

Fits **Gehl** Mower Conditioners – 770, 880, 1070, 1090. **John Deere** Mowers – 37, 38, 39, 250, 350, 450. Mower Conditioners – 480, 483, 485. Windrowers – 215, 215A, 780, 800, 880. Platform Augers – 18, 19, 183, 188, 220 & 230 prior to s/n 425000. Draper Platforms – 78, 88, 120, 130, 135

Weight: 1.61 lb (730.28 g)

HA221 (G81-0186)



OEM	OEM PN#	Buchanan PN	Order No.	Price
John Deere	E52667	BU-221	G81-0186	
John Deere	E62000	BU-221		

Fits **John Deere** Mower Conditioners – 1207, 1209, 1214; 1217, 1219 prior to s/n 710000; 1380, 1424. Platform Augers – 230 s/n 425001 and up; 240

Weight: 1.79 lb (811.93 g)

HA222DH (G81-0147)



OEM	OEM PN#	Buchanan PN	Order No.	Price
John Deere	E72428	BU-222H	G81-0147	

Fits **John Deere** Mower Conditioners and Windrowers with Platforms – 300, 300A prior to s/n 943000; Mower Conditioners – 1217, 1218 s/n 71001 & later; 1600.

Weight: 1.79 lb (811.93 g)

HA225 (G81-0187)



OEM	OEM PN#	Buchanan PN	Order No.	Price
Allis-Chalmers	1116504	BC-225	G81-0187	
Deutz-Allis	1116504	FC-225		
Gleaner	1116504	BC-225		

Fits All **Allis-Chalmers** GLEANER Combines – 1955 and later. All **Deutz-Allis** GLEANER Combines. GLEANER Headers

Weight: 1.06 lb (480.81 g)

HA231 (G81-0125)



OEM	OEM PN#	Buchanan PN	Order No.	Price
Allis-Chalmers	1176532	BU-231	G81-0125	
Hart-Carter	232155	BU-231		
	234006	BU-231		
	234239	BU-231		
	273846	BU-231		

International Harvester	179755C1	BU-231		
Deutz-Allis	1320143	BU-231		
Massey Ferguson	71320143	BU-231		
	1053174M1	BU-231		
White Farm	31-2749417	BU-231		

Fits **Allis-Chalmers** Combines – All Floating Head. **Deutz-Allis** GLEANER Combines – All Floating Head. **Hart-Carter** – All Floating Cutterbars. **International Harvester** – Combines – 810 Flex Head. **Massey Ferguson** Combines – Floating Platforms (except 9110 Flex). **White Farm** – Combines – All Floating Head.

Weight: 1.43 lb (648.64 g)

HA235 (G81-0070)



OEM	OEM PN#	Buchanan PN	Order No.	Price
Cockshutt	895744L	BU-235	G81-0070	
International Harvester	K8420S	BU-235		
Kilberry	K8420S	BU-235		
MacDon	K16716-1	BU-235		
	K8420S	BU-235		
Massey Ferguson	1041468M1	BU-235		
Oliver-White Farm	895744L	BU-235		

Fits **Cockshutt** Windrowers – All. **International Harvester** Windrower – 75. **Kilberry** Windrower. **MacDon** Windrowers – 1000 Series. **Massey Ferguson** Windrowers – 35, 665, 675, 775, 785. **Oliver White Farm** Windrowers – 501, 503.

Weight: 1.64 lb (743.89 g)

HA240 (G81-0191)



OEM	OEM PN#	Buchanan PN	Order No.	Price
John Deere	H61954	BC-240-A	G81-0191	
	H75386	BC-240-A		
	H145791	BC-240-A		
Massey Ferguson	228392M1	BC-240-A		
	228392M2	BC-240-A		
New Holland	134024	BC-240-A		
New Idea	714611	BC-240-A		
White	9510220	BC-240-A		

Fits John Deere Combine – 2-Prong, All Models. **Massey Ferguson** Combines – 2-Prong, All Models. **New Holland** Combines – Rigid Bar. **New Idea** Combines – Uni-Harvest, 71, 711, 715. **White**

Weight: 1.14 lb (517.01 g)

HA240S (G81-0021)



OEM	OEM PN#	Buchanan PN	Order No.	Price
John Deere	H145791	BC-240-S	G81-0021	

Fits **John Deere** Combines – All John Deere Platforms. **Massey Ferguson** Combines – All Rigid Bar Platforms. **New Holland** Combines – All New Holland Rigid Bar Platforms. **New Idea** Combines – 711, 713, 715. **White Farm** Combines – Fixed Cutter Bars

Weight: 1.14 lb (517.01 g)

HA245 (G81-0192)



OEM	OEM PN#	Buchanan PN	Order No.	Price
Case IH	700700845	BU-245	G81-0192	
Gehl	611179	BU-245		
	611902	BU-245		
Hesston	49239	BU-245		
	700700845	BU-245		
	748178	BU-245		
New Holland	65327	BU-245		
New Idea	BU245	BU-245		
Versatile	V94711	BU-245		
	65327	BU-245		

Fits **Case IH** Mower Conditioners – 8320, 8330, 8340, 8350, 8360, 8370, 8830. Windrowers – 8210, 8220, 8230, 8240, 8820, 8830. Auger Header – 8840. **Field Queen**. **Gehl** Mower Conditioners – 2130, 2160. Windrowers – 2230, 2262. **Hesston** Mower Conditioners – 1010, 1071, 1085, 1090, 1091, 1110, 1120, 1150, 1160. Windrowers – 310, 420, 500, 600, 620, 6200, 6400, 6610, PT10, PT12, PT7, 1014+2. Headers – 6450, 6465, 6566, 6665, 8050, 8100, 8200, 8400. **New Holland** – 970, 972. **New Idea** Combines – 815 through 820. **Versatile** – 4812, 4814

Weight: 1.72 lb (780.18 g)

HA245DH (G81-0042)



OEM	OEM PN#	Buchanan PN	Order No.	Price
Hesston	700700845	BU-245H	G81-0042	
	700707147	BU-245H		
	700716292	BU-245H		

Fits **Hesston** Mower Conditioner – All Models

Weight: 1.72 lb (780.18 g)

HA246 (G81-0246)



OEM	OEM PN#	Buchanan PN	Order No.	Price
Hesston	66603		G81-0246	

Fits **Hesston** Mower Conditioner – All Models

Weight: 1.71 lb (775.64 g)

HA250 (G81-0120)

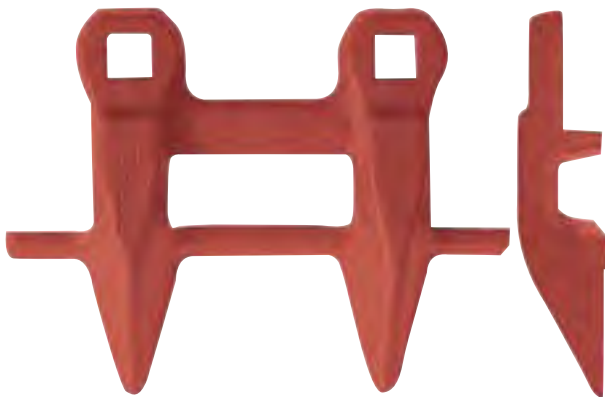

OEM	OEM PN#	Buchanan PN	Order No.	Price
Badger Northland	699020M1	BU-250	G81-0120	
Gehl	049312	BU-250		
	060494	BU-250		
Hesston	049320	BU-250		
International Harvester	472717R1	BU-250		
J.I. Case	049312	BU-250		
John Deere	E71880	BU-250		
Massey Ferguson	669020M1	BU-250		
New Holland	257635	BU-250		
	86617061	BU-250		

Fits **Badger Northland** Mowers – 1978 and Later. **Gehl** Mower Conditioners. **Hesston** Mower Conditioners. **J.I. Case** Windrowers. **John Deere** Mowers. **International Harvester** Forage Harvesters. **Massey Ferguson** Windrowers. **New Holland** Mower Conditioners

All Stub Guard Applications

Weight: 1.15 lb (521.63 g)

HA254DH (G81-0102)



OEM	OEM PN#	Buchanan PN	Order No.	Price
Hesston	700702736	BU-254-H	G81-0102	
John Deere	E59625	BU-254-H		

Fits **John Deere** Mower Conditioner – 1974 - 1978 All. Mowers 1973-2001 – All Sickle Bar. Combines – Series 200, 1976 - 1990

Weight: .96 lb (435.45 g)

HA260 (G81-0085)



OEM	OEM PN#	Buchanan PN	Order No.	Price
Field Queen	049270	BT-260	G81-0085	
Gehl	049270	BT-260		
Hesston	049270	BT-260		
International Harvester	823025C1	BT-260		
J.I. Case	049270	BT-260		
New Holland		BT-260		

Fits **Field Queen** Windrowers – 420, 620. **Gehl** Windrowers. **Hesston** Mower Conditioners – All Models, Tie Guards. **International Harvester** Windrowers – All, except – 75. **J.I. Case** Windrowers – Same as FQ245 using Tie Guards. **New Holland** Windrowers.

Weight: 1.39 lb (630.49 g)

HA265 (G81-0055)



OEM	OEM PN#	Buchanan PN	Order No.	Price
Case IH	633098R1	BC-265	G81-0055	

Fits **Case IH** Combine – 810, 815, 915 Headers

Weight: 1.38 lb (625.96 g)

HA270 (G81-0035)



OEM	OEM PN#	Buchanan PN	Order No.	Price
Case IH	613838R2	BU-270	G81-0035	
Field Queen	788278	BU-270		
Gehl	044779	BU-270		
International Harvester	613838R2	BU-270		
Kosch	K101	BU-270		
New Idea	H613838R2	BU-270		

Fits **Case IH** Mowers – 100, 110, 115, 120. Mower Conditioners – 1190, 1290, 1490, 1590. Windrowers – 75, 210, 230, 275, 375, 4000, 5000, 5500. Platforms – All 820 Platforms – Fit 110 and 1020 Platforms with Guards equipped with Cross Bar. **Field Queen** Hay Harvesters – All. **Gehl** Mower Conditioners – MA206A, HK108, HK440. **International Harvester** Windrowers – 175, 200. Mowers – All. **Kosch** Mowers – All

Weight: 2.02 lb (916.26 g)

HA275 (G81-0196)



OEM	OEM PN#	Buchanan PN	Order No.	Price
J.E. Love	LB208	BU-275	G81-0196	
	LB214	BU-275		
New Holland	273846	BU-275		
	271971	BU-275		

Fits **J.E. Love** Combines – All floating heads. **New Holland** Combines – All floating heads.

Weight: 1.30 lb (589.69 g)

HA280 (G81-0065)



OEM	OEM PN#	Buchanan PN	Order No.	Price
Ford	290385	BU-280	G81-0065	
Massey Ferguson	1036339M1	BU-280		
	320423E1	BU-250		
New Idea	290385	BU-280		

Fits **Ford** Mower Conditioner – 535. **Massey Ferguson** Hay Tender (or Tedder) – 81. **New Idea** Mower Conditioners – 290, 299. Combine – 7135

Weight: 1.63 lb (739.39 g)

HA290 (G81-0197)



OEM	OEM PN#	Buchanan PN	Order No.	Price
Versatile	9705050	BU-290	G81-0197	
	SW-1605	BU-290		

Fits **Versatile** Windrowers – 10V, 400V, 440V, 1400V, 1950V, 2400V, 4400V

Weight: 1.40 lb (635.03 g)

HA299 (G81-0037)



OEM	OEM PN#	Buchanan PN	Order No.	Price
Case IH	1307299C1	BU-299	G81-0037	

Fits **Case IH** Combine – 1020

Weight: 1.87 lb (848.22 g)

HA340 (G81-0026)



OEM	OEM PN#	Buchanan PN	Order No.	Price
John Deere	H25603	BC-340	G81-0026	
	H153855	BC-340		
Massey Ferguson	1053174M1	BC-340		

Fits **John Deere** combines – All 3-prong applications. **Massey Ferguson** Combines – All 3-prong applications

Weight: 1.50 lb (680.39 g)

HA610 (G81-0398)



OEM	OEM PN#	Buchanan PN	Order No.	Price
John Deere	H213507 H20547 H213400	BU610	G81-0398	

Fits John Deere 600 series flex heads.

HA615 (G81-0399)



OEM	OEM PN#	Buchanan PN	Order No.	Price
John Deere	H205448 H213398	BU615	G81-0399	

Fits John Deere 600 series flex heads.

HA630 (G81-0397)



OEM	OEM PN#	Buchanan PN	Order No.	Price
John Deere	H213408	BU630	G81-0397	

Fits John Deere 600 series rigid and draper headers. 900 series draper heads.

HA635 (G81-0396)



OEM	OEM PN#	Buchanan PN	Order No.	Price
John Deere	H213405	BU635	G81-0396	

Fits John Deere 600 series rigid and draper headers. 900 series draper heads.

HA641 (G81-0092)



OEM	OEM PN#	Buchanan PN	Order No.	Price
Case-IH	118301	NA	G81-0092	
MacDon	118301	NA		

Fits **Case-IH** 1042, 1052, 2042, 2052, 2062, 2142, 2152, 2162. **MacDon** 972, D50, D60, D65, FD70, FD75. **New Holland** 84C, 86C.

Left hand overlap guard for double drive heads. 1 used per machine.

HA642 (G81-0096)



OEM	OEM PN#	Buchanan PN	Order No.	Price
Case-IH	118302	NA	G81-0096	
MacDon	118302	NA		

Fits **Case-IH** 1042, 1052, 2042, 2052, 2062, 2142, 2152, 2162. **MacDon** 972, D50, D60, D65, FD70, FD75. **New Holland** 84C, 86C.

Right hand overlap guard for double drive heads. 1 used per machine.

HA643 (G81-0094)



OEM	OEM PN#	Buchanan PN	Order No.	Price
Case-IH	87422041	NA	G81-0094	
MacDon	118345	NA		

Fits **Case-IH** 1042, 1052, 2042, 2052, 2062, 2142, 2152, 2162. **MacDon** 972, D50, D60, D65, FD70, FD75. **New Holland** 84C, 86C.

Guard for drive head areas. 2-6 used per machine.

GUARDS MALLEABLE

Order Number	Replaces Number	Description	Application	Price
G81-0803	DM 700	Center Guard	7/16" Bars.	
G81-0805	DM 700-R	Outer Guard	All Except Ford	
R36-0468D	1 1/4" x 6 CS	Rivet, 1/2 lb./bx	G81-0803, G81-0805, G81-0807, G81-0808, G81-0778	
G81-0807	FD 800	Center Guard	1/2" Bars,	
G81-0778	141009	Center Guard	Ford Mowers Except 505	
G81-0181	679837M91	Center Guard	Massey Ferguson Dyna Balance Mowers	
G81-0830	MC2041Z	Center Guard	All IH	



G81-0803 G81-0830

GUARD BOLTS ASSORTMENT

For most cutter bars 7' or smaller

Size	Description	Order No	Price
7/16" X 1-3/8" (12)	No. 3 Head Guard Bolt	B55-0700	
7/16" X 1-11/16" (18)	No. 3 Head Guard Bolt		
Z10005H (30)	Conical Nuts		

GUARD BOLTS

NO. 3 HEAD (N/C BLACK)

GR. 5 HARDENED (WITH NUTS)



B55-0260

Size	Name	Mfr. Description	Pkg. Qty.	Order No	Price
7/16" x 1-1/2"	Fox	Nut & Bolt	50	B55-0260	
7/16" x 1-1/2"	Fox	Nut & Bolt	10	B55-0260D	
7/16" x 1-3/4"	Universal	Nut & Bolt	50	B55-0265	
7/16" x 1-3/4"	Universal	Nut & Bolt	10	B55-0265D	
7/16"	Universal	For 7/16" Guard Bolts	5	N83-0593D	

CARRIAGE BOLTS AND NUTS

GR. 5 PLATED (WITH NUTS)

Size	Pkg. Qty.	Order No	Price
7/16" x 1-1/2"	50	B55-0150	
7/16" x 1-3/4"	50	B55-0145	

B	
Baler Teeth.....	90, 97 - 100
C	
Combine Teeth.....	90
F	
Forage Harvester Teeth.....	97 - 100
H	
Harrow Tines.....	102 - 104
P	
Peanut Teeth.....	91
R	
Rake Teeth.....	91, 92 - 96
Rake Wheels.....	92
T	
Tedder Teeth.....	91, 92 - 96
W	
Wheel Rake Teeth.....	91

BALER TEETH

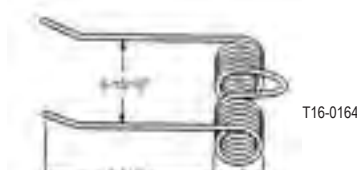

Replaces Number	Mfr. Name	No. of Prongs	Application	Order No	Price
F1226	Freeman	2, Steel	All Balers	T16-0226	
7893746	Freeman	2, Steel	1 ton Freeman, 4800 Hesston Baler	T16-0164	
7894751	Hesston	2, Steel		T16-0012	
2700222	Hesston	2, Steel		HE-6	
1710102					
7751621	Hesston	2, Steel	5600 and 5800 Balers	T16-0040	
7894306	Hesston	2, Steel		HE-5	
700706128	Hesston	2, Steel	4460 and 4650 Baler	T16-0163	
210614-C	IH	2, Steel		IH-2A	
700709210	IH	2, Steel	IH 8440 and Hesston 514	IH-2D	
700714459					
MA-74528	IH	2, Steel	45, 45T, 46, 55T, 55W, 435, 445 Balers.	IH-2B	
ZA103012	IH	2, Steel	3650	NI-3	
E81295	John Deere	2, Steel	410, 430, 500, 510 and 530	T16-0025	
E87038					
E41833	John Deere	2, Steel	327, 336, 346, 337, 347, 467 Round Balers	T16-0024	
E-79475	John Deere	2, Steel	Round Balers, 535 Baler	JD-1D-2	
276-SE	John Deere	2, Steel	14T, 24T, 214T	T16-0022	
268-SE	John Deere	2, Steel	8F with pick-up attachment	JD-2D	
P-45961	John Deere	2, Steel	Model used on belt. Pickup attachment for all combines	JD-2K	
151075M2	Massey	2, Steel	Balers up to 1958	MF-2B	
665929M1	Massey	2, Steel	3, 9, 10, 12. Balers up to 1958	MF-2C	
127566	New Holland	2, Steel	78, 67, Super 68, 69, 268, 269, 270 balers	T16-0158	
131673	New Holland	2, Steel	680, 845, 846, 847, 850, 851, 852 Super Sweep. Large round balers.	T16-0162	
683310	New Holland	2, Steel	855 up to series 733, 139	NH-1D-1	
28286	New Holland	2, Steel		NH-2C	
788853	New Holland	2, Steel	855 round, series 733, 140 to 786, 144	NH-1D-2	
103012	New Idea	2, Steel	465, 480, 485, 486, 484, 483	NI-3	
11032347	Owatonna	2, Steel	590, 595, 596	OW-2	
4059-001	Vermeer	2, Steel	Round balers E, F, & G	T16-0485	
4000-997	Vermeer	2, Rubber	Round balers Super F G, H, I, J, K, L, XL, & Rebel Series. 150, 1450 504, 505/5410, 5410, 5500.	T16-0488	
27997-001			MF 1440, 1455, 1550, 1565. Double Prong 7".		
F-413	Vermeer	2, Steel	B and C Balers	V-1	
48893001					
F-1326	Vermeer	2, Steel	D Series Baler	V-2	
29-001					

TEETH

COMBINE TEETH

Replaces Number	Mfr. Name	Description	Application	Pkg. Qty.	Order No	Price
H1611	Hume	1 Prong. Steel	Combines, Pickup Reels	100	T16-0124	
N66A	Universal	1 Prong. Flex	Nylon Flex Tine. Mounts to front of Bat		T16-0183	
N67A	Universal	1 Prong. Flex	Nylon Flex Tine. Mounts to rear of Bat	100	T16-0767	
HE1017004	Melroe	2 Prong. Flex	Combine Pickup Tooth (Plastic Flex Tooth)	100 500	T16-0050	
782551, 1989438C1, AH136689, AH153175	Pipe Reel	1 Prong. Flex	2 pc. M/L Reel Tine w/clamps & screws for 4.5" spacing	100	T16-0720	
782226, 1989438C1, AH136689, AH153175	Pipe Reel	1 Prong. Flex	2 pc. M/L Reel Tine w/clamps & screws for 4.5" spacing	10/Bag	T16-0715	
HA100MLT	Pipe Reel	1 Prong. Flex	M/L Reel Tine Only, Less Clamps; For T16-0720 & T16-0715	100/Box	T16-0725	
HA20SC	12-14 x 1"		Replacement Screw for T16-0720 or T16-0715	20/BB	B55-0096D	



PEANUT COMBINE TEETH

Replaces Number	Mfr. Name	Type	No. of Prongs	Wire Gauge	A Length	B Width	C Coil OD	Pkg. Qty.	Order No.	Price
FOR 6000 PEANUT COMBINE										
15-50-002	Lilliston	Stripper	2	.283"	4-3/4"	2-1/2"	2-1/4"	100	T16-0540	
15-50-003	Lilliston	Cylinder	2	.312"	4-3/4"	3-1/16"	2-1/4"	100	T16-0452	
60-50-226	Lilliston	Pickup	2	.177"	5-3/8"	2-1/2"	1-11/16"	100	T16-0144	
15-50-286	Lilliston	Square Bar	2	.312"	4-3/8"	2-3/4"	2-1/4"	100	T16-0458	
FOR ALL PEANUT COMBINES										
6589, 1080	Long/G-Roanoke	Breast	2	.262"	5-1/8"	2-3/4"	2-5/16"	100	T16-0470	
33-050-117	KMC	Pickup	2					100	T16-0049	
33-050-004	KMC	Cylinder	2					50	T16-0051	
33-050-005A	KMC	Stripper	2					100	T16-0053A	
33-050-095	KMC	Pickup	2					100	T16-0055	
7008	Hobbs-Adams	Cylinder	2		3.156"		1.187"	100	T16-0056	
7028	Hobbs-Adams	Stripper	2		5.65"		1-3/8"	100	T16-0057	

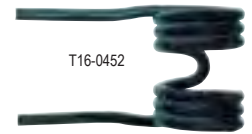

TEDDER RAKE TEETH

Replaces Number	OEM	Application	US #	Wire Color	Wire Gauge	A Length	B Width	C Coil OD	Pkg. Qty.	Order No	Price
1-043-030-10700	Fahr		FT-1	Black	.344"	12-3/4"		2-1/4"	25	FT-1	
10370000	Galfre	New Models	GS-1	Red	.375"	15-1/4"	3-1/2"	2-11/16"	20	T16-0814	
278687	New Holland	156,158,162	KT-2	Yellow	.375"	13.875"	3-5/8"	2-3/4"	25	T16-0801	
585-619-00	Kuhn	GF440, GF4000M									
585-052-10	Kuhn		KT-1	Yellow	.375"	13"		2-3/4"	25	T16-0802	
576-090-00	Kuhn	GF22N, GF5000, GF6001	KT-3	Yellow	.375"	14.125"	3-5/8"	2-3/4"	25	T16-0803	
10521R	Niemeyer		NM-1	Red	.375"	13"		2-5/16"	25	T16-0812	
10520L	Niemeyer		NM-2	Yellow	.375"	13"		2-5/16"	25	NM-2*	
PZ106	PZ Zweegers		PZ-1	Cream	.343"	11-1/8"	5-1/16"		20	PZ-1*	
PZ110	PZ Zweegers		PZ-3	Cream	.343"	9-1/4"	7-1/16"		20	PZ-3*	

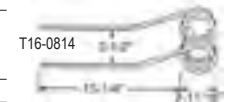
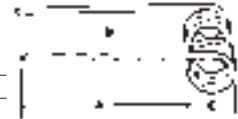

*Special Order Only. Minimum Required.

WHEEL RAKE TEETH

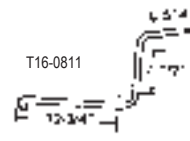
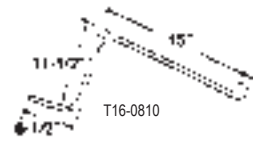
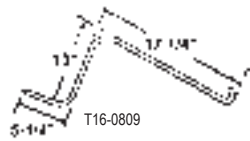
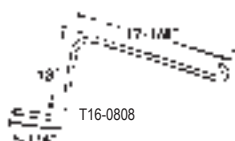

Replaces Number	OEM	Description	US #	Wire Color	Wire Gauge	Pkg. Qty.	Order No	Price
PR015	Tonutti	Right Hand	T-1	Cream	.244"	10/Pack	T16-0808D	
PL015	Tonutti	Left Hand	T-1A	Cream	.244"	10/Pack	T16-0809D	
203055	OTMA	H&S, Sitrex, Atlas, Koehn & M&W	OT-1	Cream	.262"	10/Pack	T16-0810D	
203055	OTMA	H&S, Sitrex, Atlas, Koehn & M&W	OT-1A	Cream	.281"	10/Pack	T16-0815D	
6087-54	Rossi	Rossi, Durabuilt	R-1	Cream	.262"	10/Pack	T16-0811D	
VI-1, 36133	Vicon, Kuhn	Short 10", 6 Wheel, Tonutti	VI-1	Cream	.262"	10/Pack	T16-0489D	
VI-2, 93611	Vicon	Long 12-1/2", 5 Wheel	VI-2	Cream	.262"	10/Pack	T16-0490D	



Now Sold In Convenient Packs of 10!

TEETH, SPRING - RAKES, RUBBER MOUNT

Replaces Number	No. of Prongs / Description	Application	Pkg. Qty.	Order No	Price
65668 L	1 Prong Spring Tooth, LH	NH 56B, 57, Rakes 259,216, 256, 258		T16-0154	
139041 R	1 Prong Spring Tooth, RH	260, 269 & 216 Rakes		T16-0166	
2888-001	1 Prong, LH& RH, 1-5/8" inside saddle width,	Hesston Rakes 3700, 3800, 3810, 3900, 3950. JD Rakes 700, 705. MF Rakes 585, 588. Vermeer R9, R21, R23, R23A, R24, R24A, R2300.	100	T16-0185	
AE56204					
1703743					
1058730M1					
RMT 1	1 Prong, 1-11/16" inside saddle width, offset mounting holes	Round Bar Rakes, Universal. All JD. NH 55, 56, 57, 256. AGCO, NI, IHC etc	100	T16-0182	
NH# 65609 & 850612					
RMT 2, 2117RH, 400341 & 491478	2 Prong, Rubber Mount	Fits Morrill, Farmhand, NI, Darf Rola Rake, Others	10	T16-0190	
850613D. Single	LH Rake Tooth	Allen and New Holland RolaBar Rakes	80	T16-0170	
850614D. Single	RH Rake Tooth	Allen and New Holland RolaBar Rakes	80	T16-0171	
RMT-1D. Single	1 Prong, Univ Rubber Rake Tooth, Domestic	Round Bar, Rakes Universal	80	T16-0186	
H-60003. Single	Bean Windrower Tooth	Replace Lockwood-Innes Part #504-055, Henry #H-6003	100	T16-0016	
801-0001. Single	Bean Tooth	Heath Bean Windrowers		T16-0017	
	8" From Hole To Center. 1-1/4" you, 5/16" hole, 1/4" Diameter.				

T16-0017 T16-0182



HERSCHEL 6" 2-PIECE POLY TINES FOR PIPE REELS

Fits: Agco-Gleaner 700, 800, 7000 & 8000 Series; Case-IH: 1010 & 1020 Series (2001 & Up), 2020; JD: 900 F & R Series s/n 685101 & Up, 600 Series; Massey Ferguson: 9800 & 9850 Series; New Holland: 71C, 73C, 972 & 973



- PATENTED 2 PIECE DESIGN.
- SAVE MONEY!
REPLACE ONLY THE TINE.



Description	Pkg. Qty.	Order No	Price
Tine & Clamp	100/Box	T16-0740	
Tine & Clamp	10/Box	T16-0745	
Tine ONLY	100/Box	T16-0750	

TRU-TUBE® TOOL



Auger Size	Order No	Price
12"	T55-1012	
14"	T55-1014	
16"	T55-1016	

Save down time by making in-field repairs! Allows you to straighten damaged auger tubes on grain platforms in the field.

Fits easily in your toolbox. No need for torches or pry bars to repair augers damaged by field debris.

RAKE WHEELS AND HUB

Heavy Duty, .275. Fits Sitrex, Case, H&S, M&W, New Holland, Westward & Others. Overall diameter: 56"

Description	Order No	Price
Right Hand	W16-0801	
Left Hand	W16-0802	

Replacement Tine Part Number T16-0815D.

Heavy Duty, .276" (7mm). Fits Tonutti/National/Walton, John Deere/Frontier, Vermeer, Kuhn, Miller Pro/Arts Way, Gehl. Replacement Tine: T16-0489.

Description	Order No	Price
Right Hand. P20BG003	W16-0805	
Left Hand. P20BG004	W16-0806	

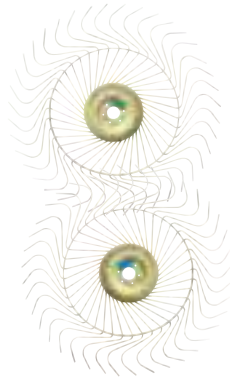

.295". Fits Sitrex, H&S, New Holland & Others. Overall diameter: 60". Black.

Description	Order No	Price
Right Hand	W16-0808	
Left Hand	W16-0807	

Replacement Tine Part Number T16-0815D.

HUB ASSEMBLY

With bearing for all wheels listed at left. Pilot: 3.21". Bolt circle: 5.12". 13mm bolt required

Order No.	Price
H16-1000	



TEETH

ALLIS CHALMERS

Order No. AC-1
531727
U.S. No. AC-1
Rake .244 Wire, Red
0.43 Lbs. 100/Case

CASE

Order No. C-1
T-1735D
U.S. No. C-1, Model 281
Rake (1960 on)
.244 Wire, Black
0.42 Lbs. 100/Case

ALLIS CHALMERS

Order No. AC-2
511506
U.S. No. AC-2
Rake .244 Wire, Black
0.74 Lbs. 100/Case

CASE

Order No. C-2
208-EB
U.S. No. C-2
Rake .244 Wire, Black
0.7 Lbs. 100/Case

CASE

Order No. T16-0305
R-740S
U.S. No. C-2A
Rake .225 Wire, Black
0.5 Lbs. 100/Case

FAHR

Order No. FT-1
 1-043-030-10700
 U.S. No. FT-1
 Tedder .344 Wire, Black
 2.0 Lbs. 25/Case

GALFRE

Order No. T16-0814
 10370000
 U.S. No. GS-1
 Tedder .375 Wire, Black
 2.8 Lbs. 20/Case

INTERNATIONAL HARVESTER

Order No. T16-0126
 457374R1 / 462978R1
 U.S. No. IH-1, IH-1A, IH-1B
 Models 3, 4, 5, 8, 9, 11, 14, 15,
 16, 30, 35, 86, 96, 97 Rakes
 .225 Wire, Red
 0.3 Lbs. 100/Case

FARMHAND

Order No. T16-0368
 L2117/FH (ID-4803R)
 U.S. FH-2
 Model F-76
 Rake
 .262 Wire, Black
 0.9 Lbs. 50/Case

FORD

Order No. T16-0340
 146545
 U.S. No. F-2
 Model 503 Rake .244 Wire, Black
 0.8 Lbs. 50/Case

INTERNATIONAL HARVESTER

Order No. IH-22-2
 455185R1
 U.S. No. IH-22-2
 Model 5, 1952 & up
 Rake .244 Wire, Red
 0.9 Lbs. 50/Case

FORD

Order No. F-2B
 143049
 U.S. No. F-2B
 Rake .244 Wire, Black
 0.82 Lbs. 50/Case

INTERNATIONAL HARVESTER

Order No. IH-22A*
 R15080
 U.S. No. IH-22A
 Model 5, 1952 & up
 Rake .244 Wire, Red
 0.9 Lbs. 50/Case

*Special Order Only. Minimum Order Required

TEETH

JOHN DEERE

Order No. T16-0330
 257-SE
 U.S. No. JD-1
 Model 350, 851, 858, 894, 896
 Rakes 24T, 216T Balers
 .244 Wire, Green
 0.4 Lbs. 100/Case

JOHN DEERE

Order No. T16-0320
 186SE
 U.S. No. JD-2G
 Models 553, 594
 Side Delivery Rake
 .244 Wire, Black
 0.7 Lbs. 100/Case

KUHN

Order No. T16-0802
 585-052-10
 U.S. No. KT-1
 Tedder
 .375 Wire, Yellow
 2.5 Lbs. 25/Case

JOHN DEERE

Order No. T16-0315
 E35277
 U.S. No. JD-1A
 Model 567 Wheel Rake
 .282 Wire, Black
 0.9 Lbs. 50/Case

KELLY RYAN

Order No. KR-2L*
 RR14L
 U.S. No. KR-2L
 Rake .244 Wire, Black
 0.7 Lbs. 100/Case

KUHN

Order No. T16-0801
 585-619-00
 U.S. No. KT-2
 Tedder Model GF440,
 GF4000M
 .375 Wire, Yellow
 2.5 Lbs. 25/Case

JOHN DEERE

Order No. T16-0325
 194SE / 237SE
 U.S. No. JD-2
 Model 14, 596, 597, 714 Rakes
 .226 Wire, Black
 0.6 Lbs. 100/Case

KUHN

Order No. T16-0803
 576-090-00
 U.S. No. KT-3
 Tedder Models GF22N,
 GF5000, GF8001
 .375 Wire, Yellow
 2.5 Lbs. 25/Case

*Special Order Only. Minimum Order Required

MASSEY FERGUSON

Order No. T16-0335
 667530M0 / 668364M1
 DE03435A
 U.S. No. MF-1, MF-1C, MF-1D
 Models 25, 36, 37
 Rakes .262 Wire, Black
 0.4 Lbs. 100/Case

NEW HOLLAND

Order No. T16-0370
 64562 / 46993
 U.S. No. NH-1A
 Model 55, 56B & 57 Rakes
 256, 258, 259, 260
 Rotobar .262 Wire, Yellow
 0.5 Lbs. 100/Case

NIEMEYER

Order No. T16-0812
 10521R
 U.S. No. NM-1
 Tedder .375 Wire, Red
 2.5 Lbs. 25/Case

MASSEY FERGUSON

Order No. T16-0367
 667656M1
 U.S. No. MF-1A
 All Rakes to 1958
 .244 Wire, Black
 0.3 Lbs. 100/Case

NEW IDEA

Order No. NI-1
 0782ME1
 U.S. No. NI-1
 Rakes 1957 on
 .244 Wire, Green
 0.4 Lbs. 100/Case

NEW HOLLAND

Order No. NH-1
 40917
 U.S. No. NH-1
 Model 55 Rake 1950
 .244 Wire, Yellow
 0.4 Lbs. 100/Case

NEW IDEA

Order No. T16-0380
 048ME & ME
 U.S. No. NI-2
 Model (4 Bar) 4, 44, 45G,
 1948 & up
 .244 Wire, Green
 0.7 Lbs. 100/Case

OLIVER

Order No. O-1
 500629E
 U.S. No. O-1
 Model 107 (5 Bar)
 Side Del. Rake, A1 Roto Bar
 .262 Wire, Black
 0.4 Lbs. 100/Case

*Special Order Only. Minimum Order Required

TEETH

FREEMAN

Order No. T16-0226

F1226
U.S. No. FR-1
Baler .187 Wire, Black
0.4 Lbs. 100/Case

HESSTON

Order No. T16-0012

7894751
U.S. No. HE-3
Baler .187 Wire, Red
0.4 Lbs. 100/Case

HESSTON

Order No. HE-6

2700222/1710102
U.S. No. HE-6
Baler .187 Wire, Red
0.4 Lbs. 100/Case

HESSTON

Order No. T16-0040

7751021
U.S. No. HE-1
Models 5600 & 5800 Balers
.187 Wire, Red
0.4 Lbs. 100/Case

HESSTON

Order No. HE-5

7894306
U.S. No. HE-5
Baler .225 Wire, Red
0.6 Lbs. 100/Case

HESSTON

Order No. T16-0164

7893746
U.S. No. HE-7
4800 Baler .207 Wire, Red
0.7 Lbs. 100/Case

HESSTON

Order No. T16-0163

700706128
U.S. No. HE-8
Baler .207 Wire, Red
Models 4460 & 4650
0.7 Lbs. 100/Case

TEETH

INTERNATIONAL HARVESTER

Order No. IH-2A
210614-C1
U.S. No. IH-2A
Baler .177 Wire, Black
0.5 Lbs. 100/Case

INTERNATIONAL HARVESTER

Order No. IH-2D
700709210 / 700714459
U.S. No. IH-2D
Models Case IH 8440
Hesston 514
Balers .193 Wire, Black
.7 Lbs. 100/Case

JOHN DEERE

Order No. T16-0025
E61295 / E67036
U.S. No. JD-1D
Models 410, 430, 500, 510, 530,
Round Balers .187 Wire, Yellow
0.43 Lbs. 100/Case

INTERNATIONAL HARVESTER

Order No. IH-2B
MA-74529
U.S. No. IH-2B
Models 45, 45T, 46, 55T, 55W, 435,
445, Balers
Models 15, 16, 55, 350, 550,
850, 200, 36, Forage Harvester
Model 122, 123, 125, 127,
141, 151, 161
Combines .177 Wire, Red
0.5 Lbs. 100/Case

INTERNATIONAL HARVESTER

Order No. NI-3
ZA103012
U.S. No. NI-3 Model 3650
Baler .193 Wire, Black
0.44 Lbs. 100/Case

JOHN DEERE

Order No. T16-0024
E11833
U.S. No. JD-1C
Models 327, 330, 346, 337, 347, 467
Round Balers .177 Wire, Yellow
0.45 Lbs. 100/Case

JOHN DEERE

Order No. JD-1D-2
E-78475
U.S. No. JD-1D-2
Round Balers, 535 Baler
.187 Wire, Green
0.52 Lbs. 100/Case

*Special Order Only. Minimum Order Required

JOHN DEERE

Order No. T16-0022
 276-SE
 U.S. No. JD-2B
 Models 14T, 24T, 214T Balers
 .187 Wire, Green
 0.4 Lbs. 100/Case

MASSEY FERGUSON

Order No. MF-2B
 151075M2
 U.S. No. MF-2B
 Balers up to 1958
 .187 Wire, Black
 0.4 Lbs. Packed 100/Case

NEW HOLLAND

Order No. T16-0158
 127566
 U.S. No. NH-1B
 Model 78, 87, Super 68, 89,
 268, 269, 270 Balers
 .187 Wire, Yellow
 0.4 Lbs. 100/Case

JOHN DEERE

Order No. JD-2D
 268-5E
 U.S. No. JD-2D
 Model 8F with Pick-up Attachment
 .177 Wire, Yellow
 0.3 Lbs. 100/Case

MASSEY FERGUSON

Order No. MF-2C
 665929M1
 U.S. No. MF-2C
 Models 3, 9, 10, 12 Balers up to 1958
 .207 Wire, Black
 0.6 Lbs. Packed 100/Case

NEW HOLLAND

Order No. T16-0162
 131673
 U.S. No. NH-1D Replaces 6651415
 Models 660, 845, 846, 847, 650, 651, 852
 Supersweep & Lg. Round Balers
 .187 Wire, Yellow
 0.5 Lbs. 100/Case

JOHN DEERE

Order No. JD-2K
 P-45961
 U.S. No. JD-2K
 Model used on belt
 Pick-up attachment for all combines
 .135 Wire, Green
 0.1 Lbs. 100/Case

TEETH

NEW HOLLAND

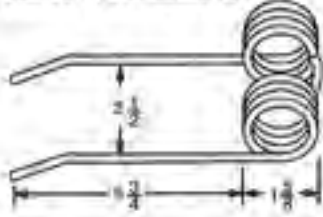

Order No. NH-1D-1

683310
U.S. No. NH-1D-1
Model 855 Round Baler
up to series 733, 139
.187 Wire, Yellow
0.5 Lbs. 100/Case

NEW HOLLAND

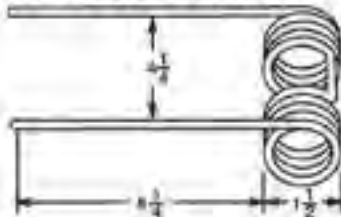

Order No. NH-2C

28286
U.S. No. NH-2C
Baler .187 Wire, Yellow
0.4 Lbs. 100/Case

VERMEER

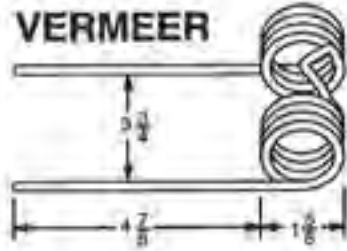

Order No. V-1

F-413 / 48893001
U.S. No. V-1
B & C Series Balers
.187 Wire, Yellow
0.5 Lbs. 100/Case

NEW HOLLAND

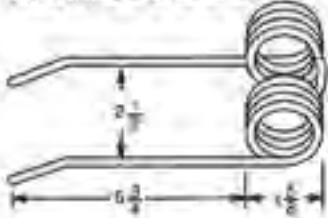

Order No. NH-1D-2

788853
U.S. No. NH-1D-2
Model 855 Round Baler
Series 733, 140 to 786, 144
.187 Wire, Yellow
0.5 Lbs. 100/Case

NEW IDEA

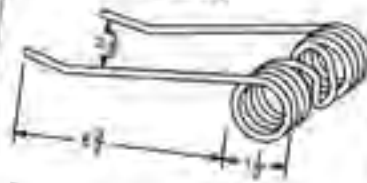

Order No. NI-3

103012
U.S. No. NI-3
Model 465 and 480, 485, 486,
484, 483
Round Baler .193 Wire, Black
0.44 Lbs. 100/Case

VERMEER

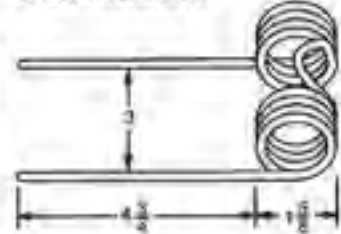

Order No. V-2

F-1326/29-001
U.S. No. V-2
D Series Baler .187 Wire,
Yellow, 0.5 Lbs. 100/Case

OWATONNA/OMC

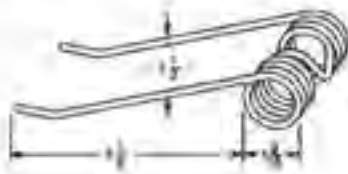

Order No. OW-2

11032347
U.S. No. OW-2
Models 590, 595, 596
Round Balers .230 Wire, Black
5 Lbs. 100/Case

VERMEER

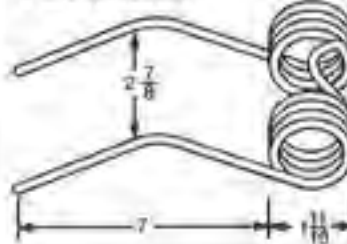

Order No. T16-0485

4059-001
U.S. No. V-3
E, F, & G Series Balers
.207 Wire, Black
0.6 Lbs. 100/Case

CASE

Order No. T16-0030
 750075
 U.S. No. HE-2
 Made by Hesston
 .225 Wire, Red
 0.75 Lbs. 100/Case

INTERNATIONAL HARVESTER

Order No. T16-0128
 540565R1
 U.S. No. IH-2G
 Model 9901 190
 .225 Wire, Red
 0.6 Lbs. 100/Case

NEW HOLLAND

Order No. T16-0032
 76517
 U.S. No. NH-2E
 Haybine Models 460, 461, 467,
 468, 472, 474, 488, 492, 903,
 907, 909, 912, 1100, 1112, 1114,
 Self Propelled model 1118
 .225 Wire, Yellow
 0.65 Lbs. 50/Case

JOHN DEERE

Order No. JD-2E
 E37596
 U.S. No. JD-2E
 Models 480, 483, 485,
 old models 1207, 1209, 1214
 .225 Wire, Yellow
 0.58 Lbs. 100/Case

HESSTON

Order No. T16-0030
 750075
 U.S. No. HE-2
 Models PT-7, PT-10, PT-12, 1012,
 1014, 1070, 1090, 420, 520, 6600
 .225 Wire, Red
 0.7 Lbs. 100/Case

JOHN DEERE

Order No. T16-0332
 E-10711
 U.S. No. JD-2E-1
 Models 1207, 1209, 1217, 1210,
 1380, 230 new models
 .244 Wire, Yellow
 0.7 Lbs. 100/Case

UNIVERSAL

Order No. UH-1
 C5-6R
 MF No. 1005399M1
 #B4 Snap Lock Finger
 U.S. No. UH-1
 Reel Tine .187 Wire, Black
 0.2 Lbs. 100/Case

TEETH

DEGELMAN

Order No. T30-0001
143101
U.S. No. DN-1
Mounted Harrow
.375 Wire, Black 3.0 Lbs.
Coil I.D. 1.85" 20/Case

FLEXICOIL

Order No. T30-0004
4341
U.S. No. FX-3
Mounted Harrow
.375 Wire, Black 2.5 Lbs.
Coil I.D. 1.84" 25/Case

HERMAN

Order No. T30-0007
8H-1110
U.S. No. HS-1
Harrow Draw Bar
.375 Wire, Black 3.5 Lbs.
Coil I.D. 2.1" 15/Case

FLEXICOIL

Order No. T30-0003
1334
U.S. No. FX-2
Harrow Draw Bar
.375 Wire, Black 2.5 Lbs.
Coil I.D. 1.75" 25/Case

GLENCOE

Order No. T30-0006
P1546
U.S. No. GL-2
Harrow
.375 Wire, Black
1.3 Lbs.
Coil I.D. 2.15" 100/Case

HERMAN

Order No. T30-0008
H-1140
U.S. No. HS-2
Mounted Harrow
.375 Wire, Black 3.5 Lbs.
Coil I.D. 2.1" 15/Case

JOHN DEERE

Order No. T30-0010
U.S. No. JD-1B-1 136767
Harrows built between 1975 & 1981
.375 Wire, Green 2.5 Lbs.
Coil I.D. 1.67" 25/Case

JOHN DEERE

Order No. T30-0011
U.S. No. JD-1B-2 181162
Harrows built between 1982 & 1985
.375 Wire, Green 2.5 Lbs.
Coil I.D. 1.75" 25/Case

JOHN DEERE

Order No. JD-1B-5
232353
U.S. No. JD-1B-5
Harrow
.412 Wire, Black 6.5 Lbs.
Coil I.D. 1.75" 15/Case

JOHN DEERE

Order No. T30-0014
135002
U.S. No. JD-1B
Harrow built prior to 1974
.375 Wire, Green 2.5 Lbs.
Coil I.D. 1.75" 25/Case

JOHN DEERE

Order No. JD-1B-3
188805
U.S. No. JD-1B-3
Harrows built after 1986
.375 Wire, Green 3.0 Lbs.
Coil I.D. 1.75" 20/Case

*Special Order Only. Minimum Order Required

KRAUSE

Order No. KS-2
76-156
U.S. No. KS-2
Mounted Harrow
.437 Wire, Black 3.5 Lbs.
Coil I.D. 2.125" 15/Case

LINDSAY

Order No. T30-0018
L-14-04760
U.S. No. LN-3
.375 Wire, Green 1.3 Lbs.
Coil I.D. 1.8" 50/Case

KOVAR

Order No. T30-0012
1238
U.S. No. K-2
Harrow
.375 Wire, Yellow 1.2 Lbs.
Coil I.D. 2.25" 50/Case

LINDSAY

Order No. T30-0016
L-14-0472B
U.S. No. LN-1
.312 Wire, Green .75 Lbs.
Coil I.D. 1.5" 100/Case

LINDSAY

Order No. T30-0017
R-14-04752
U.S. No. LN-4
.375 Wire, Black 1.3 Lbs.
Coil I.D. 1.8" 50/Case

KRAUSE

Order No. KS-1
76-126
U.S. No. KS-1
Mounted Harrow
.375 Wire, Black 2.5 Lbs.
Coil I.D. 1.75" 25/Case

LINDSAY

Order No. T30-0015
R-14-04710
U.S. No. LN-2
.312 Wire, Black .75 Lbs.
Coil I.D. 1.5" 100/Case

MATTSON

Order No. T30-0019
U.S. No. M-1
Harrow
.312 Wire, Black 1.8 Lbs.
Coil I.D. 1.62" 50/Case

*Special Order Only. Minimum Order Required

MELROE

Order No. T30-0021
6524795
U.S. No. ME-1
Harrow
.375 Wire, Black 3.5 Lbs.
Coil I.D. 1.188" 25/Case

MELROE

Order No. T16-0002
6502210
U.S. No. ME-2
Harrow
.312 Wire, Black 2.0 Lbs
Coil I.D. 1.32" 25/Case

MIDWEST

Order No. T30-0023
CH-113A
U.S. No. MW-1
Harrow
.375 Wire, Black 2.5 Lbs.
Coil I.D. 1.5" 25/Case

MORRIS

Order No. T30-0024
H-1791
U.S. No. MS-3
Mounted Harrow
.375 Wire, Black 2.9 Lbs.
Coil I.D. 1.695" 20/Case

MORRIS

Order No. T30-0025
H-4087
U.S. No. MS-2
Mounted Harrow
.375 Wire, Black 2.9 Lbs.
Coil I.D. 1.695" 20/Case

NOBLE

Order No. N-1A
U.S. No. N-1A
Harrow
.375 Wire, Black 2.6 Lbs.
Coil I.D. 1.75" 20/Case

NOBLE

Order No. T30-0009
148781
U.S. No. N-1
Mounted Harrow
.375 Wire, Black 2.5 Lbs.
Coil I.D. 1.8125" 25/Case

NOBLE

Order No. N-3
41410
U.S. No. N-3
Mounted Harrow
.375 Wire, Black 2.8 Lbs.
Coil I.D. 1.8125" 20/Case

WILRICH

Order No. T30-0027
13419
U.S. No. WR-1
Mounted Harrow
.375 Wire, Black 2.2 Lbs.
Coil I.D. 1.625" 25/Case

WILRICH

Order No. T30-0028
16429
U.S. No. WR-2
Mounted Harrow
.375 Wire, Black 2.5 Lbs.
Coil I.D. 1.625" 20/Case

	B	
Bush Hog.....		106
	C	
Case-IH.....		106
Challenger.....		106
Claas.....		106
	F	
Fahr.....		106
Fella.....		106
	G	
Gehl.....		106
	H	
Hesston.....		107
	J	
John Deere.....		107
	K	
Krone.....		107
Kuhn.....		107
	L	
Lely.....		107
	M	
M&W/Sitrex.....		107
Massey Ferguson.....		108
Mortl.....		107
	N	
New Holland.....		108
New Idea.....		108
	P	
Pottinger.....		108
PZ Zweegers.....		108
	V	
Vermeer.....		108

DISC MOWER SPECIFICATIONS

Application	Shape	Degree Of Twist	Length	Width	Thickness	Hole Diameter	Center Of Hole To Back Edge	Order No.	
Gehl, John Deere, Kuhn, NH	LH	Twisted	13	3.75	1.78	0.140	0.64	0.75	B45-6122D
Gehl, John Deere, Kuhn, NH	RH	Twisted	13	3.76	1.72	0.130	0.64	0.78	B45-6123D
New Holland, Kuhn	Both	Flat	0	3.78	1.55	0.110	0.64	0.71	B45-6175D
CIH, Gehl, MF, New Idea, Vicon	LH	Twisted	13	4.21	1.86	0.175	0.73	0.78	B45-6559D
CIH, Gehl, MF, New Idea, Vicon	RH	Twisted	13	4.21	1.86	0.175	0.73	0.78	B45-6560D
Bush Hog, Hesston	RH	Twisted	13	4.76	1.88	0.165	0.89	0.78	B45-6563D
Bush Hog, Hesston	LH	Twisted	13	4.76	1.88	0.165	0.89	0.78	B45-6564D
Kuhn, Gehl, John Deere, NH	LH	Twisted	13	4.72	1.79	0.170	0.73	0.78	B45-6565D
Kuhn, Gehl, John Deere, NH	RH	Twisted	13	4.72	1.79	0.170	0.73	0.78	B45-6566D
Hesston, Kuhn, Gehl, John Deere, NH	RH	Twisted	13	4.21	1.78	0.169	0.72	0.80	B45-6568D
Hesston, Kuhn, Gehl, John Deere, NH	LH	Twisted	13	4.21	1.78	0.169	0.72	0.80	B45-6569D
CNH, Hesston	LH	Twisted	18	4.21	1.88	0.163	0.73	0.78	B45-6572D
CNH, Hesston	RH	Twisted	18	4.21	1.88	0.163	0.73	0.78	B45-6573D
CNH, Bush Hog, New Idea, MF	LH	Twisted	18	4.76	1.88	0.165	0.89	0.78	B45-6576D
CNH, Bush Hog, New Idea, MF	RH	Twisted	18	4.76	1.88	0.165	0.89	0.78	B45-6577D
CNH, Bush Hog, New Idea, MF	RH	Twisted	18	4.44	1.88	0.157	0.89	0.80	B45-6578D
CNH, Bush Hog, New Idea, MF	LH	Twisted	18	4.44	1.88	0.157	0.89	0.80	B45-6579D
Kuhn	Both	Flat	0	3.27	1.58	0.118	0.75	0.62	B45-6702D
Fella	LH	Twisted	13	3.86	1.86	0.160	0.75	0.83	B45-6703D
Fella	RH	Twisted	13	3.86	1.86	0.160	0.75	0.83	B45-6704D
CNH, New Holland	RH	Twisted	13	4.21	1.90	0.160	0.90	0.75	B45-6720D
CNH, New Holland	LH	Twisted	13	4.21	1.90	0.160	0.90	0.75	B45-6721D
Krone	LH	Twisted	13	4.41	1.90	0.166	0.75	0.76	B45-6722D
Krone	RH	Twisted	13	4.41	1.90	0.166	0.75	0.76	B45-6723D
CNH, Hesston	LH	Twisted	18	4.21	1.89	0.157	0.73	0.75	B45-6725D
CNH, Hesston	RH	Twisted	18	4.21	1.89	0.157	0.73	0.75	B45-6726D
M&W, Sitrex	LH	Twisted	13	3.88	1.75	0.145	0.80	0.78	B45-6737D
M&W, Sitrex	RH	Twisted	13	3.88	1.75	0.145	0.80	0.78	B45-6738D
Mortl	RH	Twisted	13	3.65	1.88	0.116	0.92	0.80	B45-6760D
Mortl	LH	Twisted	13	3.65	1.88	0.116	0.92	0.80	B45-6761D
Bush Hog, Beal, CIH, Fella, Gehl, Lely, MF, New Idea, Vicon,	LH	Twisted	13	4.72	1.86	0.163	0.73	0.78	B45-6992D
Bush Hog, Beal, CIH, Fella, Gehl, Lely, MF, New Idea, Vicon,	RH	Twisted	13	4.72	1.86	0.163	0.73	0.78	B45-6993D
Hesston, Kuhn, John Deere, NH	LH	Twisted	13	3.66	1.58	0.120	0.64	0.70	B45-6996D
Hesston, Kuhn, John Deere, NH	RH	Twisted	13	3.66	1.60	0.129	0.64	0.67	B45-6997D
Krone, Fahr, Fella, PZ Zweegers, Welger	Both	Flat	0	3.78	1.64	0.125	0.75	0.75	B45-6998D

DISC MOWER KNIVES

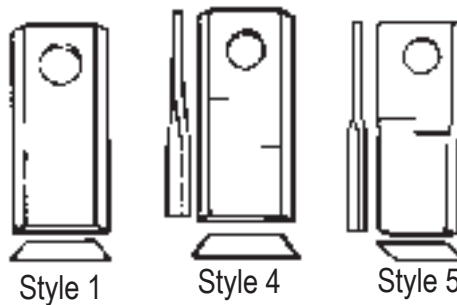

OEM Number	Application	Length Inches	Hole Dia. Inches	Style	Shape	Bolt Order No	6 Blades Order No	Price	25 Blades Order No	Price
BUSH HOG										
526216	HM5, HM7, HM8, DM7, DM8, DM9,	4.72	.728"	5	LH Twisted	B55-0357D	B45-6992D		B45-6992	
526215	DM18, DM19, 526, 527, 528	4.72	.728"	5	RH Twisted	B55-0357D	B45-6993D		B45-6993	
527746, 527749	5406, 5407, 5408, 5409, DM70	4.76	.890"	5	RH Twisted	B55-0355D	B45-6563D		B45-6563	
527747, 527748	DM80 & DM90, DM180, DM190	4.76	.890"	5	LH Twisted	B55-0355D	B45-6564D		B45-6564	
527749, 113385A1							B45-6576D		N/A	
527748, 113384A1							B45-6577D		N/A	

OEM Number	Application	Length Inches	Hole Dia. Inches	Style	Shape	Bolt Order No	6 Blades Order No	Price	25 Blades Order No	Price
CASE/IH										
700712888	725, 8309, 8312, 8315, 8850, DC515	4.21	.717"	4	RH Twisted	B55-0344D	B45-6568D		B45-6568	
700712889		4.21	.717"	4	LH Twisted	B55-0344D	B45-6569D		B45-6569	
700711857		4.21	.728"	5	RH Twisted	B55-0342D	B45-6559D		B45-6559	
700711858		4.21	.728"	5	LH Twisted	B55-0342D	B45-6560D		B45-6560	
ZA526216	306, 307, 308, 3204, 3205, 3206, 3309	4.72	.728"	5	LH Twisted	B55-0357D	B45-6992D		B45-6992	
ZA526215		4.72	.728"	5	RH Twisted	B55-0357D	B45-6993D		B45-6993	
113385A1	3204, 3205, 3206	4.76	.890"	5	RH Twisted	B55-0355D	B45-6563D		B45-6563	
113384A1		4.76	.890"	5	LH Twisted	B55-0355D	B45-6564D		B45-6564	
9847684	MD72, MD82, MD92, RD132, MDX71, MDX81, MDX91, RD162, DCX91, DCX101, DCS131, DCX161, RDX131, RDX161, RDX181	4.21	.9"	5	LH Twisted	N/A	B45-6721D		N/A	
9847683		4.21	.9"	5	RH Twisted	N/A	B45-6720D		N/A	
527749, 113385A1	18° Top Bevel. 3204, 3205, 3260, 3309	4.76"	.89"	5	LHTwisted	B55-0355D	B45-6576D		N/A	
527748, 113384A1	18° Top Bevel. 3204, 3205, 3260, 3309	4.76"	.89"	5	RHTwisted	B55-0355D	B45-6577D		N/A	
700715575, 700715576	18° Bottom Bevel. 725, 8850, DC515, 8309, 8312, 8315	4.21"	.728"		LHTwisted	B55-0342D	B45-6572D		B45-6572	
86625673, 86625674	18° Bottom Bevel 725, 8850, DC515, 8309, 8312, 8315	4.21"	.728"		RHTwisted	B55-0342D	B45-6573D		B45-6573	
	18° Top Bevel. 725, 8850, DC515, 8309, 8312, 8315	4.21"	.728"	5	LHTwisted	B55-0342D	B45-6725D		B45-6725	
	18° Top Bevel. 725, 8850, DC515, 8309, 8312, 8315	4.21"	.728"	5	RHTwisted	B55-0342D	B45-6726D		B45-6726	
*13° ANGLE										
CHALLENGER										
527749	HTD7, HTD8, HTD9, PTD9	4.76	.890"	5	RH Twisted	B55-0355D	B45-6563D		B45-6563	
527748		4.76	.890"	5	LH Twisted	B55-0355D	B45-6564D		B45-6564	
700712888	DKH12, DKH15, DKHB, DKHC, DKHCT, PTD10, PTD12, PTD15	4.21	.717"	4	RH Twisted	B55-0344D	B45-6568D		B45-6568	
700712889		4.21	.717"	4	LH Twisted	B55-0344D	B45-6569D		B45-6569	
700711857		4.21	.728"	5	RH Twisted	B55-0342D	B45-6559D		B45-6559	
700711858		4.21	.728"	5	LH Twisted	B55-0342D	B45-6560D		B45-6560	
CLAAS										
978 241.4		3.78	.748"	1	Flat	N/A	B45-6998D		N/A	
FAHR										
1-1012-030-115.00	KM20, KM22, KM24, KM25,	3.78	.748"	1	Flat	N/A	B45-6568D		B45-6568	
0656 1542	KM2.17, KM2.19, KM2.33	3.78	.748"	1	Flat	N/A	B45-6998D		B45-6998	
1101901028220.83		3.27	.75"	1	Flat	N/A	B45-6702D			
FELLA										
477 740	SM, 165, SM240	3.78	.748"	1	Flat	N/A	B45-6998D		B45-6998	
478 640	SM120 Old & SM240 Old	4.72	.728"	4	LH Twisted	B55-0344D	B45-6565D		B45-6565	
111 724		4.72	.728"	5	LH Twisted	B55-0342D	B45-6992D		B45-6992	
111 725		4.72	.728"	5	RH Twisted	B55-0342D	B45-6993D		B45-6993	
121712LH	SM165, SM240 Prior to 1989	3.86	.75"	5	LH Twisted	N/A	B45-6703D		N/A	
121713RH		3.86	.75"	5	RH Twisted	N/A	B45-6704D		N/A	
GEHL										
604658	1080, 2350, 2330, 2310, 140, 160, DC1080, DC2350, DM140, DM160	4.72	.728"	5	RH Twisted	B55-0342D	B45-6992D		B45-6992	
604659		4.72	.728"	5	LH Twisted	B55-0342D	B45-6993D		B45-6993	
613727	162	3.76	.640"	4	LH Twisted	B55-0358D	B45-6122D		B45-6122	
613728		3.76	.640"	4	RH Twisted	B55-0358D	B45-6123D		B45-6123	
90261559	CM216, 2330 s/n 2227 & up	4.21	.728"	5	RH Twisted	B55-0342D	B45-6559D		B45-6559	
90261560		4.21	.728"	5	LH Twisted	B55-0342D	B45-6560D		B45-6560	
113269	1162, 1165, 2345, 2365, 2412, 2415, 2418	4.21	.717"	4	RH Twisted	B55-0344D	B45-6568D		B45-6568	
113268		4.21	.717"	4	LH Twisted	B55-0344D	B45-6569D		B45-6569	
HESSTON										
700713983	1320, 1340, 1345, 1355, 1360, 1365, 1375	4.21	.717"	4	RH Twisted	B55-0344D	B45-6568D		B45-6568	
700713984	3312, 3315, 8070, 8500, 9070, 9075, 9080, 9190, 9192	4.21	.717"	4	LH Twisted	B55-0344D	B45-6569D		B45-6569	
527746	1004, 1005, 1006, 1007, 1008, 3006,	4.76	.890"	5	RH Twisted	B55-0355D	B45-6563D		B45-6563	
527747	3007, 3008, 3009, 3010, 3309	4.76	.890"	5	LH Twisted	B55-0355D	B45-6564D		B45-6564	
DM303	1030, 1035, 1040, 1050, 1060	3.66	.640"	4	LH Twisted	B55-0358D	B45-6996D		B45-6996	
DM304		3.66	.640"	4	RH Twisted	B55-0358D	B45-6997D		B45-6997	
700715576	8500	4.21	.728"	5	RH Twisted	B55-0342D	B45-6559D		B45-6559	
700715575		4.21	.728"	5	LH Twisted	B55-0342D	B45-6560D		B45-6560	
86625673	18° Bottom Bevel. 8070, 1320, 1340, 1360, 1365	4.21	.728"		LH Twisted	B55-0342D	B45-6572D		B45-6572	
86625674		4.21	.728"		RH Twisted	B55-0342D	B45-6573D		B45-6573	
86625673	18° Top Bevel. 8070, 1320, 1340, 1360, 1365	4.21	.728"	5	LH Twisted	B55-0342D	B45-6725D		B45-6725	
86625674		4.21	.728"	5	RH Twisted	B55-0342D	B45-6726D		B45-6726	
JOHN DEERE										
CC19336	1314, 1315	3.66	.640"	4	LH Twisted	B55-0358D	B45-6996D		B45-6996	
CC19333		3.66	.640"	4	RH Twisted	B55-0358D	B45-6997D		B45-6997	
CC20500, CC44005	1320, 1326, 1327, 240, 260	3.76	.640"	4	LH Twisted	B55-0358D	B45-6122D		B45-6122	
CC20501, CC44006		3.76	.640"	4	RH Twisted	B55-0358D	B45-6123D		B45-6123	
CC21780	1320, 1326, 1327, 265, 270, 275, 285	4.82	.717"	4	LH Twisted	B55-0344D	B45-6565D		B45-6565	
CC21781		4.82	.717"	4	RH Twisted	B55-0344D	B45-6566D		B45-6566	
E80208	525, 530, 535, 625, 630, 635, 730, 735	4.21	.717"	4	RH Twisted	N/A	B45-6568D		B45-6568	
E80206	830, 835, 910, 915, 916, 920, 925, 926, 930, 935, 936, 945, 946, 955, 956, 990, 994, 995, 1340, 1350, 1360, 1460, 1470	4.21	.717"	4	LH Twisted	N/A	B45-6569D		B45-6569	



Style 1



Style 4



Style 5

OEM Number	Application	Hole Dia.		Style		Bolt Order No	6 Blades		25 Blades	
		Length Inches	Inches	Style	Shape		Order No	Price	Order No	Price
KRONE										
143 698.0		3.78	.748"	1	Flat	N/A		B45-6998D		B45-6998
1372-24-27		3.27	.75"	1	Flat	N/A		B45-6702D		N/A
1398880	323 Shaft Drive	4.41	.75"	5	LH Twisted	N/A		B45-6722D		N/A
1398890		4.41	.75"	5	RH Twisted	N/A		B45-6723D		N/A
138880, 1398883								B45-6723		N/A
138890, 1398893								B45-6722		N/A
KUHN										
561.500.00	GMD 41, 55, 66	3.78	.640"	1	Flat	B55-0358D				B45-6175
561.512.00	GMD Std Mowers before 1976	3.66	.640"	4	LH Twisted	B55-0358D	B45-6996D			B45-6996
561.513.00		3.66	.640"	4	RH Twisted	B55-0358D	B45-6997D			B45-6997
561.512.10	GMD Std after 1976	3.76	.640"	4	LH Twisted	B55-0358D	B45-6122D			B45-6122
561.513.10	240, 260, 452, GMD44, GMD55, GMD66	3.76	.640"	4	RH Twisted	B55-0358D	B45-6123D			B45-6123
564.512.00	HD or GMD 44, 55,	4.82	.717"	4	LH Twisted	B55-0344D	B45-6565D			B45-6565
564.513.00	66 & 77	4.82	.717"	4	RH Twisted	B55-0344D	B45-6566D			B45-6566
559.033.10	GMD 283TG, 400, 500, 600, 700, 800, 801,	4.21	.717"	4	RH Twisted	B55-0344D	B45-6568D			B45-6568
559.032.10	600GII, 700GII, 800GII, FC 243, 250, 283, 300, 302, 303, 313, 350, 352, 353, 813, 883, 4000, Alterna 400, 500	4.21	.717"	4	LH Twisted	B55-0344D	B45-6569D			B45-6569
LELY										
		4.72	.728	5	RH Twisted	B55-0357D	B45-6993D			B45-6993
		4.72	.728	5	LH Twisted	B55-0357D	B45-6992D			B45-6992
M&W/SITREX										
3238726					LH Twisted		B45-6737D			
3238725					RH Twisted		B45-6738D			
MORTL										
T673R					RH Twisted		B45-6760D			
T673L					LH Twisted		B45-6761D			
MASSEY FERGUSON										
527749	1306, 1307, 1308, 1309, 1310, 1326, 1327,	4.76	.890"	5	RH Twisted	B55-0355D	B45-6563D			B45-6563
527748	1328, 1329, 1330, 1339, 1359	4.76	.890"	5	LH Twisted	B55-0355D	B45-6564D			B45-6564
700712888	1345, 1355, 1365, 1372, 1375, 9070, 9075,	4.21	.717"	4	RH Twisted	B55-0344D	B45-6568D			B45-6568
700712889	9080, 9175, 9185	4.21	.717"	4	LH Twisted	B55-0344D	B45-6569D			B45-6569
700711858		4.21	.728	5	RH Twisted	B55-0342D	B45-6560D			B45-6560
700711857		4.21	.728	5	LH Twisted	B55-0342D	B45-6559D			B45-6559
DM303	164, 166, 530	3.66	.640"	4	LH Twisted	B55-0358D	B45-6996D			B45-6996
DM303		3.66	.640"	4	RH Twisted	B55-0358D	B45-6997D			B45-6997
NEW HOLLAND										
274230	All 442 & 462	3.70	.640"	1	Flat	B55-0358D	B45-6175D			B45-6175
784220	411 to 711915, 453, 463	4.84	.717"	4	LH Twisted	B55-0344D	B45-6565D			B45-6565
784221		4.84	.717"	4	RH Twisted	B55-0344D	B45-6566D			B45-6566
274096	462 to 51121643	3.66	.640"	4	LH Twisted	B55-0358D	B45-6996D			B45-6996
274097		3.66	.640"	4	RH Twisted	B55-0358D	B45-6997D			B45-6997
766726	462 after 51121643, 452, 442	3.74	.640"	4	LH Twisted	B55-0358D	B45-6122D			B45-6122
766727		3.74	.640"	4	RH Twisted	B55-0358D	B45-6123D			B45-6123
853819	408, 411, 412, 415	4.21	.717"	4	RH Twisted	B55-0344D	B45-6568D			B45-6568
853820		4.21	.717"	4	LH Twisted	B55-0344D	B45-6569D			B45-6569
9847684	615, 616, 617, 720HD, 750HD, 1409, 1410,	4.21	.9"	5	LH Twisted	N/A	B45-6721D*			N/A
9847683	1411, 1412, 1431, 1432, 1441, 1442, 2331, 232, 2353, 2355, 2358, DCX101, DCX131, DCX161, RDX161, H6730, H6740, H6750, H7220, H72230H H7320, H7330	4.21	.9"	5	RH Twisted	N/A	B45-6720D*			N/A
113385A1	18° Top Bevel. 3204, 3205, 3260, 3309	4.76	.89	5	LH Twisted	B55-0355D	B45-6576D			N/A
113384A1	18° Top Bevel. 3204, 3205, 3260, 3309	4.76	.89	5	RH Twisted	B55-0355D	B45-6577D			N/A
700715575	18° Bottom Bevel. 725, 8850, DC515, 8309, 8312, 8315	4.21	.728		LH Twisted	B55-0344D	B45-6572D			B45-6572
700715576	18° Bottom Bevel. 725, 8850, DC515, 8309, 8312, 8315	4.21	.728		RH Twisted	B55-0344D	B45-6573D			B45-6573
700715575	18° Top Bevel. 725, 8850, DC515, 8309, 8312, 8315	4.21	.728	5	LH Twisted	B55-0344D	B45-6725D			B45-6725
700715576	18° Top Bevel. 725, 8850, DC515, 8309, 8312, 8315	4.21	.728	5	RH Twisted	B55-0344D	B45-6726D			B45-6726
84271023					RH Twisted		B45-6578D			
84271205					LH Twisted		B45-6579D			

*13° Angle Blade

DISC MOWER KNIVES & BOLTS/NUTS

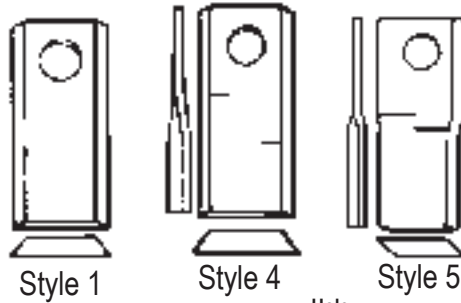

OEM Number	Application	Length Inches	Hole Dia. Inches	Style	Shape	Bolt Order No	6 Blades Order No	Price	25 Blades Order No	Price
NEW IDEA										
527746	5209, 5212, 5312, 5406, 5407, 5408,	4.76	.890"	5	RH Twisted	B55-0355D	B45-6563D		B45-6563	
527747	5409, 5410,	4.76	.890"	5	LH Twisted	B55-0355D	B45-6564D		B45-6564	
526216	5209, 5212, 5406, 5407, 5408, 5409, 5410,	4.72	.728"	5	LH Twisted	B55-0357D	B45-6992D		B45-6992	
526215	526, 527, 528	4.72	.728"	5	RH Twisted	B55-0357D	B45-6993D		B45-6993	
	5070, 5512, 5515, 6070	4.21	.728"	5	LH Twisted	B55-0342D	B45-6560D		B45-6560	
		4.21	.728"	5	RH Twisted	B55-0342D	B45-6559D		B45-6559	
700712888		4.21	.717"	4	RH Twisted	B55-0344D	B45-6568D		B45-6568	
700712889		4.21	.717"	4	LH Twisted	B55-0344D	B45-6569D		B45-6569	
POTTINGER										
700.06.1650		3.78	.748"	1	Flat	N/A	B45-6998D		B45-6998	
PZ ZWEEGERS										
DM155, DM303	230, 265, 275, 320	3.66	.640"	4	LH Twisted	B55-0358D	B45-6996D		B45-6996	
DM160, DM304		3.66	.640"	4	RH Twisted	B55-0358D	B45-6997D		B45-6997	
MT452S		3.78	.748"	1	Flat	N/A	B45-6998D		B45-6998	
VERMEER										
DM303	230, 275, 320	3.66	.640"	4	LH Twisted	B55-0358D	B45-6996D		B45-6996	
DM304		3.66	.640"	4	RH Twisted	B55-0358D	B45-6997D		B45-6997	
VICON										
902-58699	AM3200, CM165, CM167, CM240, CM247,	4.72	.728"	5	LH Twisted	B55-0357D	B45-6992D		B45-6992	
902-58700	CM1700, KM240, KM241, KM281, KM321,	4.72	.728"	5	RH Twisted	B55-0357D	B45-6993D		B45-6993	
	CM2400, DMP2400, DMP3200, KM3200,									
	KM4000, KMR3800, KMT3001									
902-61559	CM216, CM217, OM216, OM281, KM216,	4.21	.728"	5	LH Twisted	B55-0342D	B45-6559D		B45-6559	
902-61560	KM281, KM391LP, GMR2800, CM2200,	4.21	.728"	5	RH Twisted	B55-0342D	B45-6560D		B45-6560	
	AM2800									
902-61559	CM2800, DMP2800, KM2800	4.21	.717"	4	RH Twisted	B55-0344D	B45-6568D		B45-6568	
WELGER										
0982.15.06.00		3.78	.748"	1	Flat	N/A	B45-6998D		B45-6998	
3208.01.03.44		3.78	.748"	1	Flat	N/A	B45-6998D		B45-6998	

DISC MOWER SKID SHOES

Fits White, NI, Bush Hog, Case/IH-240, S/N14022-14039. Replaces 526875.

Order No.	Price
P44-0950	

DISC MOWER KNIFE BOLTS

6 bolts & 6 nuts per blister box

Replaces Number	Mfr. Name	Description / Application	Order No	Price
527745K	Bush Hog, Case/IH, NI		B55-0355D	
527733K	Bush Hog	DM7, 8, 9, 18, 19, HM5, HM7, HM8	B55-0357D	
526903	Case/IH	3204, 3205, 3206, 3309	B55-0357D	
122181-Bolt	Fella		B55-0368D	
122187-Nut				
	Hesston	1006, 1007	B55-0357D	
CC19929K	John Deere	1320, 1326, 1327, 240, 260	B55-0358D	
1377.26.6K	Krone	Includes 141.053.4 Bolt & 909.602.1 Nut	B55-0356D	
561.501.00K	Kuhn	For GMD41, 44, 55, 66, 240, 260, 452.	B55-0340D	
561.158.00K	Kuhn	Heavy Duty, for CMD 500, 600, 801,	B55-0344D	
00772647	Rhino	FC250, 300, GMD66HD, GMD77HD, DC19765, CC1934, CC19989		
562.101.00K	Kuhn	GMD44, 55, 66	B55-0358D	
	New Idea	5209, 5212, 5406, 5407, 5408, 5409, 5410	B55-0357D	
81160K	Vicon	Fits all models	B55-0342D	



B55-0358D

DISC MOWER KNIVES

E
Easy Ricer Parts..... 111

R
Razor Cat Parts..... 111

S
Silver Tiger Cutting Parts For Combines 112
Silver Tiger Cutting Parts For Hay Machines 112

T
Tiger Jaws Conversion Kits..... 113
Tiger Jaws Replacement Sickles..... 113
Tiger Jaws Splice Kits 114
Tiger Jaws Spliced Sickles..... 113
Tiger Jaws Replacement Parts..... 113
Tiger Jaw Update Kits 114

EASY RICER CUTTERBAR KITS & PARTS

Replaces

Number	Size	Description	Application	Order No	Price
ER1600	16'	Complete Easy Ricer Kit	AC, Case IH, JD, MF	C83-0529	
ER1800	18'	Complete Easy Ricer Kit	AC, Case IH, JD, MF	C83-0518	
ER2000	20'	Complete Easy Ricer Kit	AC, Case IH, JD, MF	C83-0531	
ER2200	22'	Complete Easy Ricer Kit	AC, Case IH, JD, MF	C83-0532	
ER2400	24'	Complete Easy Ricer Kit	AC, Case IH, JD, MF	C83-0085	
ER 2500	25'	Complete Easy Ricer Kit	AC, Case IH, JD, MF	C83-0525	
MRK960	25'	Mac Don 960 Kit	Mac Don 960	C83-0535	
ERLS2-14S	2'	2' Lower Segment (Bolt-On)14 Serr.	All Easy Ricer Applications	S35-3013	
ERLS2	2'	2' Lower Segment (Bolt-On), Super 7	All Easy Ricer Applications	S35-3524	
ERS 16	16'	XH7 TS-Sickle (Less Head)	AC, Case IH, JD, MF	S35-3116	
ERS 18	18'	XH7 TS-Sickle (Less Head)	AC, Case IH, JD, MF	S35-3118	
ERS 22	22'	XH7 TS-Sickle (Less Head)	AC, Case IH, JD, MF	S35-3122	
ERS 24	24'	XH7 TS-Sickle (Less Head)	AC, Case IH, JD, MF	S35-3124	
ERS 25	25'	XH7 TS-Sickle (Less Head)	AC, Case IH, JD, MF	S35-3125	
ERS 25	30'	XH7 TS-Sickle (Less Head)	AC, Case IH, JD, MF	S35-3130	
MC468		Wear Plate	All Easy Ricer Applications	P44-0417	
		Adjustable Clip-Lo Arch	All Easy Ricer Applications	C45-0041	
232135		Hold Down Clip - Hi	All Easy Ricer Applications	C45-0052	
2TC-14S	25/Box	XHTS Miniature Section. 2". 1-1/4" Hole Spacing. 2-3/4" Long. With Slot		S20-3404P	
2TC	25/Box	XH7TS-Miniature Section. 2". 1-1/4" Hole Spacing. 2-3/4" Long. With Slot	All Easy Ricer Kits Lower Seg.	S20-3521P	
SSL192D	10/Box	XH7 TS-Rice Section. No Slot	All Easy Ricers Except Mac Don	S20-3370	
L192DCR	10/Box	XH TS CR Section. No Slot		S20-4608	
0922CB	10/Box	XH TS Section. No Slot		S20-3364	
H300	10/Box	XHTS Section, 3" x 2-3/4". No Slot		S20-3405	
H400	10/Box	XHTS Section, 4" x 2-7/8". No Slot		S20-3458	
9/16 CSZP	1#	9/16" Rivet, 1 lb./BB	All	R36-0469D	



- Simple bolt-on conversion
- Time and money savings
- Faster ground speed, especially in down and tangled rice.

Easy Ricer packages are complete cutterbar conversion kits. Kits include: Full length riveted sickle (less drive head) with black 14-tooth sections, lower segments (to replace guards), adjustable hold down clips, wear plates, and hardware.

RAZOR CAT REPLACEMENT PARTS

All Razor Cat Parts Are Subject to Availability

Description	Application	Order No	Price
1" Head Bolt w/Nut, 15/BB	As Required	B55-0085D	
1-1/4" Head Bolt w/Nut, 12/BB	As Required	B55-0095D	
Section Nut, 20/Bag	As Required	N83-0289D	
3/8" x 1 3/8". Special Bolt w/Nut, 25/Bag	As Required - AC, JD, MF, & Hiniker	B55-0139	
3/8" Flange Nut, 50/Bag	As Required - AC, JD, MF, & Hiniker	N83-0334	
7/16" x 1-3/8", Carriage Bolt w/Nut, 25/Bag	As Required - Case IH, NH, & All Hay	B55-0138	
7/16" x 2", Carriage Bolt w/Nut, 25/Bag	As Required - Case IH, NH, & All Hay	B55-0200	
7/16" Flange Nut, 50/Bag	As Required - Case IH, NH, & All Hay	N83-0333	
Spacer, 1/16" x 1-1/8" Wide	As Required	S60-0331	
Spacer, 1/8" x 1-1/8" Wide	As Required	S60-0272	
Clip, High	All - Over Drive Head	C45-0693	



C45-0032

COMBINE CONVERSION KITS

HERSCHEL REPLACEMENT PARTS FOR SILVER TIGER

Description	Order No	Price
Guard, RH 4 Point (JD & IH)	G81-0004	
Overlap Section Kit	S20-4004	
Overlap Strap	S78-0466	
Replacement Sickle Head for Case-IH 820 Series	H15-0431	
Replacement Sickle Head for Case-IH 1020 Series	H15-0432	
Replacement Sickle Head for AC II,300,400,500 Series	H15-0433	
Splice Kit	C83-0760	
Adjustable Hold Down Clip - Combines	C45-0036	
Adjustable Hold Down Clip - Hay Machines	C45-0037	
Section Bolts, 12 - 24 x 5/8" Carriage Bolt, 50/BB	B55-0035D	
Section Head Bolt Pkg., (10) 7/8" x (15) 1-1/8" /BB	B55-0036D	
Guard Bolt, 7/16" x 1-3/8", w/Lock Nut, 25/Bag	B55-0138	
Guard Bolt, 3/8" x 1-3/8", w/Lock Nut, 25/Bag	B55-0139	

SILVER TIGER SICKLE DRIVE HEADS FOR HAY MACHINES

Application	Order No	Price
Hesston 420, 520, 620, 6200, 6400, 6450, 6465, 6600, 6610, 1014. Also Gehl 2230, Case 1275	H15-0439	
New Holland 1475, 2300, 2450, 2550	H15-0462 (LH)	

TIGER JAWS 2000

UNIVERSAL CONVERSION KITS

A Complete Cutterbar Conversion for Floating & Rigid Combines

- Newly designed adjustable hold down clips! No Shims Required.
- New Super 7 sections with seven teeth per inch for a more aggressive, sharper bite!
- New rugged heat-treated 2-foot wear plate!
- Proven original 1.5" cutting system!
- Low maintenance and easy installation!
- Two-prong sections and four-prong guards make four times more cuts per cycle!
- Increased ground speed for faster cutting!
- Reduced shatter loss for up to 5% yield increase!
- Can pay for itself in just one harvest!

MADE IN THE USA

New Adjustable Hold Down Clip

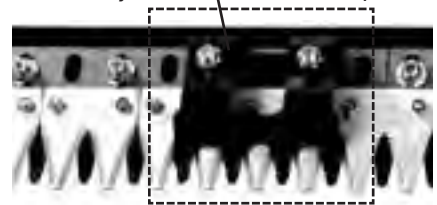

Ordering Information: Conversion Component Kits include everything you need to convert your machine to a Tiger Jaws System. Conversion Kit. Components such as Base Kits, Spliced Sickles, Hardware Kits and any Extras Required may be ordered separately to eliminate duplicate inventory or to Complete Conversion Kits. For headers over 20', order 5' Extension Kits as required. Heads must be ordered separately.

Complete Conversion Kit: Includes adjustable hold down clips, UPS shippable spliced sickle, slotted 2-point Super 7 sections, 2' heat treated wear plates, 4-prong guards, all hardware and detailed instructions.

Base Kit: Includes all 4-prong guards, all adjustable hold down clips, all 2' heat treated wear plates, one 6-prong guard, and one high arch clip for the head.

Spliced Sickle: UPS shippable spliced sickle with Super 7 sections.

Hardware Kit: Includes all standard length and extra long carriage bolts, all locking flange nuts, and all required spacers.

Extras Required: Items such as shims, 3-prong guards, and specialty hardware and clips are included in Complete Conversion Kits, but will need to be ordered separately if Conversion Kit Components are ordered individually.

5' Extension Kit: Order as required for headers over 20' in length. Some applications may require cutting the knife back.

Application	Base Size	Hardware Kit	Spliced Sickle	Extras Kit	5' Extn. Kit Required	(Order as Req.)	Complete Kit Order No	Price
AC III, 500 800	16'	C83-0846	S35-2889	C83-0449	(2)S60-0272		C83-2007*	
	20'	C83-0847	S35-2890	C83-0450	(2)S60-0272	C83-2021	C83-2016**	
AC Rigid 300	16'	C83-0846	S35-2889	C83-0449	(2)S60-0331, (1)G81-0769		C83-2027	
	20'	C83-0847	S35-2890	C83-0450	(2)S60-0331, (1)G81-0769	C83-2021	C83-2028	
HC I, II, III	16'	C83-0846	S35-2889	C83-0449	(2)S60-0285, (1) S60-0651		C83-2004	
	20'	C83-0847	S35-2890	C83-0450	(2)S60-0285, (1) S60-0651	C83-2021	C83-2013	
H 820	16.5'	C83-0846	S35-2891	C83-0449	(34)S31-0999, (1)G81-0581		C83-2008	
	20'	C83-0847	S35-2892	C83-0450	(41)S31-0999	C83-2022	C83-2017	
H1020	17.5'	C83-0849	S35-2910	C83-0449			C83-2024	
	20'	C83-0850	S35-2892	C83-0450		C83-2023	C83-2025	
JD 200, 900, Hiniker	16'	C83-0846	S35-2891	C83-0447			C83-2003	
	20'	C83-0847	S35-2892	C83-0448		C83-2020	C83-2012	
Love	16'	C83-0846	S35-2889	C83-0449	(1)C45-0693, (2) S60-0284		C83-2006	
	20'	C83-0847	S35-2890	C83-0450	(1)C45-0693, (2) S60-0284	C83-2021	C83-2015	
MF 9000	16'	C83-0846	S35-2889	C83-0447	(1) B55-0472, (1) B55-0473		C83-2001	
	20'	C83-0847	S35-2890	C83-0448	(1) B55-0472, (1) B55-0473	C83-2019	C83-2010	
MF 1859	16'	C83-0846	S35-2889	C83-0449	(2)S60-0272		C83-2005	
	20'	C83-0847	S35-2890	C83-0450	(2)S60-0272	C83-2021	C83-2014	
MF Hiniker	16'	C83-0846	S35-2889	C83-0447			C83-2002	
	20'	C83-0847	S35-2890	C83-0448		C83-2019	C83-2011	
N.H. 972, 973	16' Sgl	C83-0846	S35-2891	C83-0449	(1)S60-0272, (1)G81-0769	C83-2022	C83-2009	
	20' Dbl	C83-0847	S35-2501* S35-2502*	C83-0450	(1)S60-0272, (1)G81-0769 (1)C45-0693, (1)G81-0770	(1) C83-2026/25' (2) C83-2022/30'	C83-2018	
Tiger Jaw Display							C83-0142	

Tiger Jaw Display

* 1 Each Required for 20

**Use Rear Position On Guards

SPLICED SICKLES - DOUBLE DRIVE (LESS HEAD) - 1.5" SYSTEMS

Bolted Super 7

OEM Number	Section Number	H7TSCR No. Of Sections	Size	Segments				2.5' Ext. Seg.	5' Ext. Seg.	Complete Sickle Order No	Price
				5'LH Head Seg.	5'LH Overlap Seg.	5'RH Head Seg.	5'RH Overlap Seg.				
851663	SSTJ6700	40	20'LH	1	1	-	-	-	-	S35-2501	
851662	SSTJ6700	38	20'RH	-	-	1	1	-	-	S35-2502	
9842587	SSTJ6700	50	25'LH	1	1	-	-	1	-	S35-2503	
9842536	SSTJ6700	48	25'RH	-	-	1	1	1	-	S35-2504	
9850456	SSTJ6700	60	30'LH	1	1	-	-	-	1	S35-2505	
9820457	SSTJ6700	58	30'RH	-	-	1	1	-	1	S35-2506	

Use H15-0060 LH Head, H15-0061 RH Head if needed. (For Tiger Jaw applications only.) Use H15-0752 Head if needed. (For OEM 1.5" Systems only.)

REPLACEMENT SICKLES - Bolted with Super 7 Sections

Replaces Number	Size	Application	Order No	Price	Replaces Number	Size	Application	Order No	Price
1-Piece Universal with Super 7 sections					Spliced Universal with Super 7 sections				
TJ4-U2000	4'	All TJ Kits - Less Head	S35-2860		TJ4-U2000	4'	All TJ Kits - Less Head	S35-2860	
TJ5-U2000	5'	w/2" Hole Spacing	S35-2276		TJ5-U2000	5'	w/2" Hole Spacing	S35-2276	
TJS16-U2000	16'	In Knife Back	S35-2153		TJ8-U2000	8'	In Knife Back	S35-2861	
TJS20-U2000	20'		S35-2155		TJ8.5-U2000	8.5'	Head Segment	S35-2862	
TJ4-U2116	4'	All TJ Kits- Less Head	S35-2271		TJ4-U2116	4'	All TJ Kits - Less Head	S35-2271	
TJ5-U2116	5'	w/2-1/16" Hole Spacing	S35-2277		TJ5-U2116	5'	w/2-1/16" Hole Spacing	S35-2277	
TJS16-U2116	16'	In Knife Back	S35-2154		TJ8-U2116	8'	In Knife Back	S35-2858	
TJS20-U2116	20'		S35-2156		TJ8.5-U2116	8.5'	Head Segment	S35-2859	

For both the original Tiger Jaws and Tiger Jaws 2000 series.

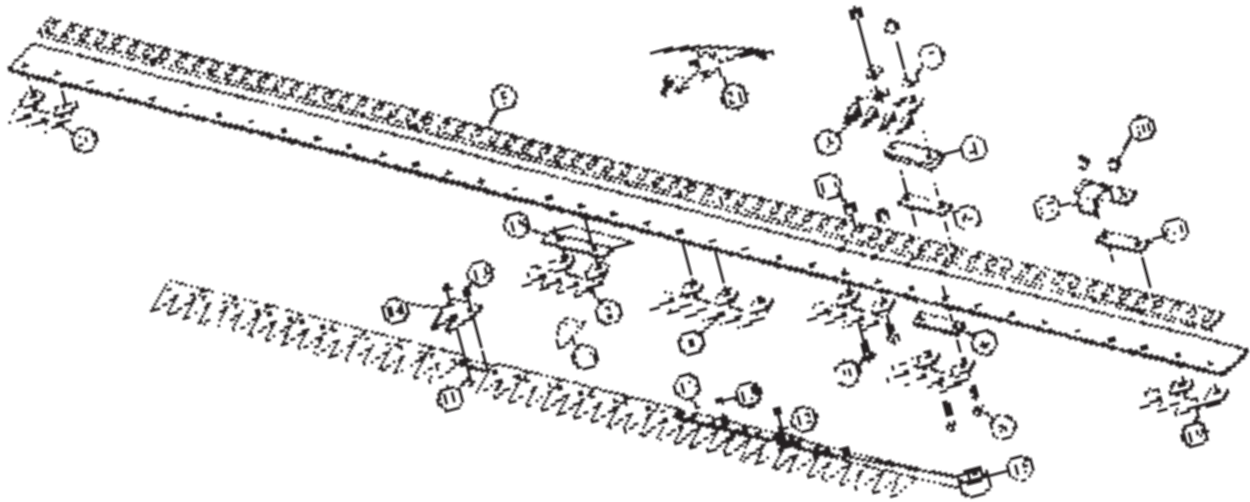

COMBINE CONVERSION KITS

Key Code Number	OEM Number	Description	Pkg Qty	Order No	Price
1	TJ44 - 6A	Guard, 6 Point All Except IHC 1020	Each	G81-0446	
1	TJ66-6W	Guard, 6 Point Wide Slot IHC 1020 Only	Each	G81-0788	
2	TJ44 - 4A	Guard, 4 Point All Except IHC 1020	Each	G81-0581	
2	TJ66-4	Guard, 4 Point IHC 1020 Only	Each	G81-0826	
2	TJ44-4W	Guard, 4 Point IHC 1020 Positions 2, 3, & 4. Wide Flange Nut	Each	G81-0827	
NI	N/A	Clip Kit, Adjustable, 3/8" Hardware (New Style). Lock Nut	Each	C45-0003	
NI	N/A	Clip Kit, Adjustable, 7/16" Hardware (New Style)	Each	C45-0004	
NI	N/A	Clip Adjuster, 2 Used per Clip (New Style)	Each	C45-0001	
NI	N/A	Clip, Steel, Adjustable Hold Down (New Style)	Each	C45-0002	
4	TJ460	Spacer, 1/16", 2 Hole, AC Rigid Only	20/Bag	S60-0331	
5	FLW24HT	2 Ft. Wear Plate, Heat Treated	Each	P44-0200	
5	TJ11WP	Wear Plate, 1 Foot, Heat Treated, IHC 1020 Only	Each	P44-0660	
6	TJ4116	Spacer, 1/8"	20/Bag	S60-0272	
6A	TJ417	Shim, .017", 2 Hole	20/Bag	S60-0328	
7	TJ45K	Retainer, 7/16"; not required w/TJ2000	10/Bag	R34-0154	
8	TJ214SBN	Carriage Bolt, Special 3/8" x 2-1/4" w/7/16" Head w/Nut - JD	25/Bag	B55-0203	
8	TJ200BN	Carriage Bolt, 7/16" x 2" w/Nut - Case-IH, H-C, NH, JE Love, AC, MF	25/Bag	B55-0200	
9	TJ138SBN	Carriage Bolt, Special 3/8" x 1-3/8" w/7/16" Head w/Nut - JD	25/Bag	B55-0139	
9	TJ138BN	Carriage Bolt, 7/16" x 1-3/8" w/Nut - Case-IH, H-C, NH, JE Love, AC, MF 1859	25/Bag	B55-0138	
10	TJ38WFN	Flange Nut, 3/8" - JD, MF 9000 Series	50/Bag	N83-0334	
10	TJ716FN	Flange Nut, 7/16" - Case-IH, H-C, NH, JE Love, AC, MF 1859	50/Bag	N83-0333	
11	TJ55BN50	Section Bolt & Nut, 5/8"	50/BB	B55-0065D	
12	TJ85BN	Head Bolt & Nut, 1"	15/BB	B55-0085D	
12	TJ95BN	Head Bolt & Nut, 1 -1/4"	12/BB	B55-0095D	
14	SSTJ6700	Section, Universal, Fits 2" & 2-1/16" Hole Spacing - Super Seven	10/BB	S20-4409	
14	SSTJ6000	Section, 2" Hole Spacing - Super Seven	10/BB	S20-4316	
14	TJ6000	Section, 2" Hole Spacing	10/BB	S20-4638	
14	SSTJ7000	Section, 2-1/16" Hole Spacing - Super Seven	10/BB	S20-4317	
14	TJ7000	Section, 2-1/16" Hole Spacing	10/BB	S20-4639	
14A	TJ1200	Half Section	10/BB	S20-0297	
15	71358960	Sickle Head AC Series 3 & 300	Each	H15-0228	
15	180859C91	Sickle Head, (AC, IH, MR) w/Hart Carter Gen III Floating Cutterbar	Each	H15-0194	
15	TJAH89498HD	Sickle Head, John Deere 200 & 900 Series Prior to 1996	Each	H15-0952	
15	AH89498	Sickle Head, John Deere 900 Series After 1996	Each	H15-0004	
15	AH75308	Sickle Head JD Hiniker & Quick Tach	Each	H15-0395	
16	TJ122KR	Reinforcement Strap 2" Hole Spacing	Each	S78-0052	
16	TJ121KR	Reinforcement Strap 2-1/16" Hole Spacing	Each	S78-0051	
17	BSH500	High Arch Hold Down	Each	C45-0693	
18	TJ6SS	Skid Shoe, IHC 820 Only	Each	S31-0999	
19	TJ44-3L	Guard, 3 Point LH, NH 972 & AC III, 500, 800 Rigid 4300	Each	G81-0769	
20	TJ44-3R	Guard, 3 Point RH, NH 972, Double Drive	Each	G81-0770	
NI*		IH 820 Head	Each	H15-0640	
NI*		IH 810 Head (not floating)	Each	H15-0294	
NI*		810 Flex Head	Each	H15-0194	

NI* - Not Illustrated N/A - Not Applicable

SPLICE KITS

Description	Order No	Price
Splice Kit w/bolts & nuts, 2" Spacing	C83-0750	
Splice Kit w/bolts & nuts, 2-1/16" Spacing	C83-0755	
Bolt & Nut Kit for Spliced Sickles, 12/BB	B55-0049D	

UPDATE KITS

Converts Original Tiger Jaw Systems to the All New Tiger Jaw 2000 System. Includes Adjustable Hold Down Clips w/Hardware & Heat Treated Wear Plates.

Ordering Instructions:

To Convert your existing machine, order kits below as required, (i.e.) Order 5 Kits for a 20' Machine.

Size	Application	Order No	Price
4'	All TJ Systems w/3/8" Guard Bolts	C83-0740	

B

Baler Chain..... 117
Belting..... 116 - 117
 Allis..... 116
 Case-IH..... 116
 Ford..... 116
 Gehl..... 116
 Hesston..... 116
 John Deere..... 116
 Massey 116 - 117
 New Idea..... 117
 Vicon 117
 Vermeer 117

R

Repair Kits..... 117

FREE SHIPPING ON BALER BELTS ORDERS OVER \$150.00!

Keys to Successful Baler Belt Replacement

1. Replace all belts at the same time.
2. If you do decide to replace a few select belts, resize the old ones to match the new ones.
3. All belts should be the same ply. Two and three-ply belts will not carry the same tension and will not operate properly when mixed.
4. Three-ply texture belts work great for heavy-duty applications such as high density bales and silage bales due to their reduced slippage.
5. Eliminate catch points such as weld splatters, sharp edges and debris.
6. Check for bent or broken rollers.
7. Check all bearings.

Smooth/Textured

Rough

Mini Rough

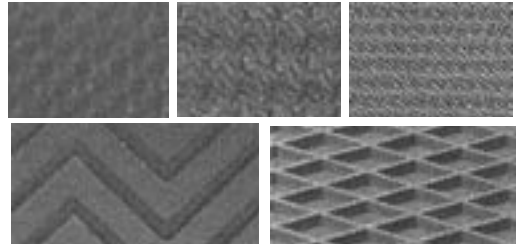

Chevron

Diamond

We Carry Many Additional Models And Styles Not Listed Here. Please Call for Price and Availability.

2-PLY BELTS

3-PLY BELTS

Mfg.	Model	Position	Belts Per Baler	Belt Size	Type	Order No.	Price	Type	Order No.	Price
AC	Roto Baler	Upper	6	5.5" x 72"	Textured	AC750AF2		Textured	AC750AN2	
		Lower	6	5.5" x 102"	Textured	AC700AF2		Textured	AC700AN2	
Case/IH	241, 2400	Upper	9	4" x 431"	Textured	UN714AF2		Textured	UN714AN2	
		Lower (No V Guide)	1	60" x 120"	Textured	IH700AF2				
Case/IH	3450	Upper (Early)	30	4.75" x 73.25"	Textured	UN776AF2		Textured	UN776AN2	
		Upper (Newer)	15	11" x 73.25"	Textured	UN768AF2		Textured	UN768ANC2	
		Lower	5	11" x 103.5"	Textured	UN772AF2		Textured	UN772AN2	
Case/IH	3640	Upper	20	11" x 73.25"	Textured	UN768AF2		Textured	UN768ANC2	
		Lower	4	11" x 121.25"	Textured	UN774AF2				
Case/IH	3650	Upper (Early)	55	4.75" x 73.25"	Textured	UN776AF2		Textured	UN776AN2	
		Upper (Newer)	25	11" x 73.25"	Textured	UN768AF2		Textured	UN768ANC2	
		Lower	5	11" x 121.25"	Textured	UN774AF2				
Case/IH	8420	Upper	5	4.8" x 364"	Textured	UN710AF2		Chevron	UN710ANC2	
Case/IH	8440	Upper	9	4" x 452"				Chevron	UN712ANC2	
Case/IH	8480	Upper	25	11" x 73.25"	Textured	UN768AF2		Chevron	UN768ANC2	
		Lower	5	11" x 121.25"	Textured	UN774AF2				
Ford	551	Upper (Inner)	3	5" x 450"	Textured	UN726AF2		Textured	UN726AN2	
		Upper (Outer)	2	6" x 450"	Textured	UN725AF2		Textured	UN725AN2	
		Lower (Newer)	1	44.25" x 56.5"	Textured	UN703AF2				
		Lower (Early)	1	44.25" x 69.5"	Textured	UN701AF2				
Ford	552	Upper	6	6" x 466"	Textured	UN775AF2		Textured	UN775AN2	
		Lower	1	60" x 96"	Textured	UN702AF2				
Gehl	1400	Upper (Inner)	3	5" x 450"	Textured	UN726AF2		Textured	UN726AN2	
		Upper (Outer)	2	6" x 450"	Textured	UN725AF2		Textured	UN725AN2	
		Lower (Newer)	1	44.25" x 56.5"	Textured	UN703AF2				
Gehl	1450, 1460	Upper	5	6" x 462.5"	Textured	GB760AF2		Textured	GB760AN2	
		Lower	1	44.25" x 56.5"	Textured	UN703AF2				
Gehl	1465, 1470	Upper	6	6" x 462.5"	Textured	GB760AF2		Textured	GB760AN2	
		Lower	1	44.25" x 56.5"	Textured	UN703AF2				
Gehl	1500	Upper	9	4" x 466"	Textured	GB750AF2		Textured	GB750AN2	
		Lower	1	60" x 96"	Textured	UN702AF2				
Gehl	1500A, 1600	Upper	6	6" x 466"	Textured	UN775AF2		Textured	UN775AN2	
		Lower	1	60" x 96"	Textured	UN702AF2				
Gehl	1850, 1860	Upper	7	6" x 546"	Textured	GB765AF2		Textured	GB765AN2	
		Lower	1	60" x 56.5"	Textured	GB705AF2				
Gehl	1865, 1870	Upper	8	6" x 546"	Textured	GB765AF2		Textured	GB765AN2	
Hesston	514	Upper	25	11" x 73.25"	Textured	UN768AF2		Chevron	UN768ANC2	
		Lower	5	11" x 121.25"	Textured	UN774AF2				
Hesston	530, 5530	Upper	5	4.8" x 364"	Textured	UN710AF2		Chevron	UN710ANC2	
Hesston	540	Upper	6	7" x 366"				Chevron	UN796ANC2	
Hesston	5400	Upper (not punched)	9	4" x 127"	Textured	HE725AF2		Chevron	HE725ANC2	
Hesston	5500, 5510	Upper	9	4" x 452"	Textured			Chevron	UN712ANC2	
Hesston	5540	Upper	6	5.3" x 470"	Textured			Chevron	UN740ANC2	
Hesston	5580	Upper	8	5.3" x 470"	Textured			Chevron	UN740ANC2	
Hesston	5600	Lower	1	60" x 120"	Textured	UN700AF2				
Hesston	5800	Upper	9	4" x 480"	Textured	HE775AF2		Chevron	HE775AF2	
John Deere	410	Upper	6	4" x 415"	Textured	LJD725AF2		Textured	LJD725AN2	
		Upper	Optional	10" x 415"	Textured	LJD726AF2		Textured	LJD726AN2	
		Upper	Optional	12" x 415"	Textured	LJD727AF2		Textured	LJD727AN2	
John Deere	430, 435	Upper	4	7" x 525"				Diamond	LJD735AND2	
		Upper	4	7" x 525"				Textured	LJD735AN2	
John Deere	500	Upper	9	4" x 422"	Textured	LJD750AF2		Textured	LJD750AN2	
		Lower	1	60" x 138"	Textured	LJD700AF2				
John Deere	510	Upper	9	4" x 484"	Textured	LJD775AF2		Textured	LJD775AN2	
John Deere	530, 535	Upper	4	7" x 525"				Diamond	LJD735AND2	
		Upper	4	7" x 525"				Textured	LJD735AN2	
		Upper	4	7" x 531"				Diamond	LJD736AND2	
		Upper	4	7" x 531"				Textured	LJD736AN2	
Massey	450	Upper	8	4" x 388"	Textured	UN715AF2		Textured	UN715AN2	
		Upper	Optional	9" x 388"	Textured	UN716AF2		Textured	UN716AN2	
		Lower	1	60" x 120"	Textured	UN700AF2				

Belts			2-PLY BELTS				3-PLY BELTS			
Mfg.	Model	Position	Per Baler	Belt Size	Type	Order No.	Price	Type	Order No.	Price
Massey	560	Upper	9	4" x 440"	Textured	UN735AF2		Textured	UN736AN2	
		Upper	Optional	10" x 440"	Textured	UN736AF2		Textured	UN736AN2	
Massey	645	Upper	6	6.5" x 528"	Textured	UN795AF2		Textured	UN795AN2	
Massey	1440, 1450, 1455	Upper	3	4" x 436"	Textured	UN780AF2		Textured	UN780AN2	
Massey	1455	Upper	2	9" x 436"	Textured	UN781AF2		Textured	UN781AN2	
Massey	1565	Upper	6	4" x 512"	Textured	UN745AF2		Textured	UN745AN2	
		Upper (inner Optional)	2	10" x 512"	Textured	UN746AF2		Textured	UN746AN2	
New Idea	483, 484	Upper (Early)	30	4.75" x 73.25"	Textured	UN776AF2		Textured	UN776AN2	
		Upper (Newer)	15	11" x 73.25"	Textured	UN768AF2		Textured	UN768ANC2	
		Lower	5	11" x 103.5"	Textured	UN772AF2		Textured	UN772AN2	
New Idea	485	Upper	15	11" x 73.25"	Textured	UN768AF2		Textured	UN768ANC2	
		Lower	5	11" x 121.25"	Textured	UN772AF2		Textured	UN772AN2	
Vicon	560	Upper	25	11" x 73.25"	Textured	UN768AF2		Textured	UN768ANC2	
		Lower	5	11" x 121.25"	Textured	UN774AF2		Textured	UN774AN2	
Vicon	RP1510	Upper	55	4.75" x 73.25"	Textured	UN776AF2		Textured	UN776AN2	
		Upper (Newer)	25	11" x 73.25"	Textured	UN768AF2		Textured	UN768ANC2	
		Lower	5	11" x 121.25"	Textured	UN774AF2		Textured	UN774AN2	
Vermeer	403F, 403G	Upper	6	4" x 358"	Textured	VR710AF2		Textured	VR710AN2	
Vermeer	504C	Upper	8	4" x 388"	Textured	UN715AF2		Textured	UN715AN2	
		Upper	Optional	9" x 388"	Textured	UN716AF2		Textured	UN716AN2	
Vermeer	504F, 504G, 504H	Upper	8	4" x 436"	Textured	UN780AF2		Textured	UN780AN2	
		Upper	Optional	9" x 436"	Textured	UN781AF2		Textured	UN781AN2	
		Upper	Optional	10" x 436"	Textured	UN782AF2		Textured	UN782AN2	
Vermeer	504I, 504IS	Upper	6	6" x 428"	Textured	VR750AF2		Textured	VR750AN2	
Vermeer	505I, 505 super I	Upper	8	6" x 424"	Textured	VR750AF2		Textured	VR750AN2	
Vermeer	605B	Upper	9	4" x 388"	Textured	UN715AF2		Textured	UN715AN2	
Vermeer	605A, 605B	Lower	1	60" x 120"	Textured	UN700AF2				
Vermeer	605C	Upper	9	4" x 440"	Textured	UN735AF2		Textured	UN736AN2	
		Upper	Optional	10" x 440"	Textured	UN736AF2		Textured	UN736AN2	
Vermeer	605D	Upper	9	4" x 450"	Textured	VR725AF2		Textured	VR725AN2	
		Upper	Optional	10" x 450"	Textured	VR726AN2		Textured	VR726AN2	
Vermeer	605E	Upper (Modification)	5	4" x 440"	Textured	UN735AF2		Textured	UN736AN2	
		Upper (Modification)	2	10" x 440"	Textured	UN736AF2		Textured	UN736AN2	
Vermeer	605F, 605G, 605H	Upper	6	4" x 512"	Textured	UN745AF2		Textured	UN745AN2	
		Upper	3	9" x 512"	Textured	UN743AF2		Textured	UN743AN2	
		Upper (Inside)	Optional 2	10" x 512"	Textured	UN746AF2		Textured	UN746AN2	
Vermeer	605J, 605 Super J	Upper	8	6.5" x 528"	Textured	UN795AF2		Textured	UN795AN2	
Vermeer	605K	Upper	2	6.5" x 528"	Textured	UN795AF2		Textured	UN795AN2	

BALER CHAIN FOR NEW HOLLAND

Model	Type	Description	Replaces OEM No.	Quantity Required	Standard Links	Special Links	Order No.	Price
850	Floor	CA550-78-C5EB-19	710395	8	78	19	770446	
851, 852	Floor	CA550-65-C5EB-16	718096	8	65	16	770586	
850, 851, 852	Floor Repair Section	CA550-3-C5EB-1		-	3	1	770818	
845	Upper	CA557-180-U16-60	404545	Matched Pair	180	60	770826	
846, 847	Upper	CA557-192-U16-64	634335	Matched Pair	192	64	770834	
848 (s/n 714629-later)	Upper	CA557-228-U16-57	855594	Matched Pair	228	57	770842	
849	Upper	CA557-240-U16-80	679303	Matched Pair	240	80	770859	
850	Upper	CA557-216-U16-72	273260	Matched Pair	216	72	770966	
851, 852	Upper	CA557-234-U16-78	679768	Matched Pair	234	78	770974	
853	Upper	CA557-248-U16-62		Matched Pair	248	62	770982	
All	Upper Repair Section		639219	Matched Pair			771014	

UNIVERSAL SPLICE ACCESSORIES

Description	Order No.	Price
Clipper .109 dia connecting pin. 15'	B22-5001	
4 - 7" Clipper 3-4-1/2 HT splices per card	B22-5003	
8 - 4" Clipper 4-1/2 RHTX splices per card	B22-7004	
4 - 7" Clipper 4-182 RHTX splices per card	B22-7007	
4 - 7" Alligator rivet laces strips per card	B22-7009	
8 Alligator corrugated pins per card	B22-7010	
7" vise for clipper lacing	CVICE7	



GATHERING WHEELS

Unique blend of rubber compounds offering durability and performance. The tough rubber fingers resist breakage and provide a longer service life.

Make/Model	Description	Order No.	Price
CASE-IH			
8450 & 8455	24" x 9" Hub & Wheel 24" x 9" Gathering Wheel	W29-0400 W29-0405	
GEHL			
1500, 1600, 1850, 1860	28" x 12 Gathering Wheel	W29-0415	
HESSTON			
530, 540, 745	24" x 9" Hub & Wheel Replacement Wheel	W29-0400 W29-0405	
550, 555, 560, 565	Wheel Wedge (3 per wheel)	W29-0410	
5540 & 5545	Wheel Wedge (3 per wheel)	W29-0410	
5580 & 5585	Wheel Wedge (3 per wheel)	W29-0410	
JOHN DEERE			
430, 435, 466, 467	Wheel Wedge (3 per wheel)	W29-0410	
MASSEY FERGUSON			
1560, 1745	24" x 9" Gathering Wheel	W29-0405	
NEW HOLLAND			
640, 648, 660, 688	28" x 12 Gathering Wheel	W29-0415	
VERMEER			
504 I, 504 L, 504 SI, 505 I, 504 SI, 554 XL, 555 XL, 604 J, 604 K, 605 J, 605 K, 604 L, 605L, 605 SJ, 604 SJ, 604 XL, 605 XL, 5400 Rebel, 5410 Rebel, 5420 Rebel, 5500 Rebel, 5520 Rebel, 540 M Classic, 664 Rancher, 665 Rancher, 6640 Rancher, 6650 Rancher	24" x 9" Gathering Wheel	W29-0405	
504 F, 504 G, 504 H, 605 F, 605G, 605H	28" x 12" Gathering Wheel	W29-0415	



HUB AND GATHERING WHEEL ASSEMBLY

Gathering wheel hub and wheel assemblies are available to replace older syle wheels commonly found on many earlier baler models. Wheel assembly can be mounted on either side by simply loosening the bolts and reversing the hub assembly. Bearings not included.



GATHERING WHEEL

Wheels provide the reliable performance you expect from OEM quality gathering wheel. Bolt holes are pre-punched for ease of installation and offered pattern fits most balers equipped for this wheel style.



WHEEL WEDGE

Die-cut from 4-ply 440 1/4" x 1/16" grade 2 industrial conveyor belt, three segments can be combined to make a single wheel. Segments provide a durable and economical wheel option and is ideal for certain older model balers.

POPULAR ITEMS!

ROUND BALER BELTS

- Nylon fabric reinforcement in the outer ply to help the belt stretch under heavy loads.
- Polyester center ply helps lace retention and stablase belt
- Belt & lacing meet or exceed OEM specifications
- 3-Ply belt offers increased durability saving downtime.

Make/Model	Description	Order No.	Price
CASE-IH			
RBX461,561, 562 NH, 650, 654, BR750, 660, 664, 668, 780, BR780	7" X 420.5" 3-Ply Mini Rough Top With Clipper	CNH7X420MC	
JOHN DEERE			
430, 435, 466, 467, 530, 535, 566, 567	7" x 531" 3-Ply Diamond Top With Alligator Lacing 7" x 525" 3-Ply Diamond Top With Alligator Lacing	JD7X531DA JD7X525DA	
VERMEER			
504 I (older model), 504-IS(silage), 505 Super I, 504 Super I, 5400 Rebel, 504L, 505-I (older model)	6" x 424" 3-Ply LMP Top With Clipper Lace	VER6X424IMC	



Mini Rough Top



Diamond Top

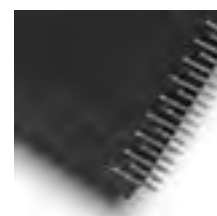

LMP Top

MOWER CONDITIONER

Model	Description	RPM	Tractor Yoke	Implement End	Order No.	Price
AGCO, Hesston 1340, 1345	Complete Driveline	1000	1-3/8 x 21 Spline	1-1/2 Round w/3/8" Keway	H14656849	
CIH 8312, Massey Ferguson PTD12, New Idea 5512	Tractor Half Implement Half				H8314656849 H8214656849	
CIH DC132, CNH 1431	Complete Driveline	1000	1-3/8 x 21 Spline	1-1/2" 23 Spline	H14656853	
	Tractor Half Implement Half				H8314656853 H8214656853	
CIH DC132, CNH 1431	Complete Driveline	1000	1-3/4 x 20 Spline	1-1/2" 23 Spline	H14756853	
	Tractor Half Implement Half				H8314756853 H8214656853	



ROUND BALER

Model	Description	RPM	Tractor Yoke	Implement End	Order No.	Price
John Deere 430, 435, 466, 467, 530, 535, 566, 567	Complete Driveline w/Clutch	540 1000	1-3/8 x 6 Spline 1-3/8 x 21 Spline	1-3/8" 6 Spline 1-3/8" 6 Spline	H14503500 H14603500	
John Deere 430, 435, 466, 467, 530, 535, 566, 567	Complete Driveline w/CV-No Clutch	540	1-3/8 x 6 Spline		H14503558	
John Deere 435, 466, 467, 535, 566, 567	Tractor Half Tube End W/CV	540	1-3/8 x 6 Spline	1-11/16" x 20 Spline	H19503506	
John Deere 430, 435, 466, 467, 530, 535, 566, 567	Complete Driveline w/CV-No Clutch Tractor Half Tube End W/CV	1000	1-3/8 x 21 Spline	1-11/16" x 20 Spline	H14603558 H19603521	
John Deere 447, 449, 457, 458, 458S, 459, 467, 468, 469, 547, 557, 558, 559, 567, 568, 569 w/CAT 4	Tractor Half Tube End W/CV	540	1-3/8 x 6 Spline	1-5/16" x 20 Spline	H9214558659	
John Deere 447, 457, 468, 468S, 469, 547, 557, 568, 569 W/CAT 4	Tractor Half Tube End W/CV	1000	1-3/8 x 6 Spline	1-5/16" x 20 Spline	H9214658659	
John Deere 447, 448, 457, 467, 547, 567 W/CAT 5	Tractor Half Tube End W/CV	540	1-3/8 x 6 Spline	1-11/16" x 20 Spline	H9214503559	
John Deere 467, 468, 468S, 567, 568 W/CAT 5	Tractor Half Tube End W/CV	1000	1-3/8 x 21 Spline	1-11/16" x 20 Spline	H9214603559	

A	
Air Seeder Spoons.....	155
Alabama Sweeps.....	154
Alfalfa Spikes.....	157
Ammonia Knives.....	161
Anhydrous Knives.....	161
Application Charts, Tillage.....	135

B	
Bearing, Disc.....	144
Bearing, Drill Disc.....	144
Bearings, Gauge Wheel.....	149
Beet Hoes.....	158
Blades, Disc.....	142 - 143
Blades, Drill Disc.....	163
Blades, Harrow.....	142 - 143
Blades, Peanut.....	154
Bolts, Plow.....	136
Bubble Coulters.....	141

C	
Caps, Ripper.....	159
Caps, Subsoiler.....	159
Chain, Covering.....	136
Chisel Plow Sweeps.....	156, 157
Chisel Points.....	157 - 158
Chisel Sweeps.....	156, 157
Chrome Plated Plow Bolts.....	136
Clipped Head Bolt.....	136
Clips, Hammer Lock.....	136, 155
Concave Coulters.....	141
Cone Style Disc Blades.....	142
Conservation Points.....	159
Cotton Stalk Puller Blade.....	141
Coulters.....	141
Covering Chain.....	136
Crescent Hoes.....	158
Cultivator Gauge Tires.....	149
Cultivator Gauge Wheel Bearings.....	149
Cut Out Disc Blades.....	141 - 142

D	
Danish Bolts.....	136
Danish Sweeps.....	156
Danish Tine Clamps.....	156
Danish Tines.....	156
Disc Axles.....	143
Disc Bearings.....	144 - 147
Disc Blade Application Charts.....	134
Disc Blade Terminology.....	133
Disc Blade Warranty Policy.....	133
Disc Blades.....	142 - 143
Disc Blades, Cone Style.....	142
Disc Blades, Flat Center.....	143
Disc Blades, Special Concavity.....	143
Disc Replacement Parts.....	147 - 148
Double Disc Openers.....	162 - 163
Drill Disc Assemblies.....	162 - 163
Drill Disc Bearings.....	163
Drill Disc Blades.....	163
Drill Disc Parts.....	162 - 164
Drill Points.....	161
Dust Caps, Drill Disc.....	164
Dust Caps, Grain Drill.....	164

E	
Elliptical Head Bolts.....	136

F	
Fertilizer Knives.....	161
Fertilizer Tubes.....	161
Field Cultivator Sweeps.....	154
Flat Center Disc Blades.....	143
Flat Coulters.....	141
Flat Center Disc Blades.....	143
Fluted Coulters.....	141
Furrowers.....	155

G	
Gauge Wheel Bearings.....	149
Gauge Wheel Halves.....	149
Gauge Wheel Tires.....	149
Gauge Wheels.....	149
Grain Drill Covering Chains.....	136
Grain Drill Disc Assemblies.....	162 - 163

G continued	
Grain Drill Parts.....	162 - 163
Grain Drill Points.....	161
Graphite.....	153
Grass Knife, NH3.....	161
Ground Hog Knife.....	161

H	
Hammer-Lock Sweeps.....	155
Hardware.....	136
Hardware, Drill Disc.....	164
Harrow Blades.....	142 - 143
Harrow Shoes.....	160
Harrow Tines.....	160
Hoe Wheels.....	159
Hoes, Beet.....	158
Hoes, Crescent.....	158
Hoes, Tender Plant.....	158
Hoes, Vegetable.....	158

J	
Joyce Sweeps.....	154

K	
Knives, Ammonia.....	161
Knives, Anhydrous.....	161
Knives, Fertilizer.....	161
Knock On Sweeps.....	155

L	
Landsides.....	122 - 124, 138
Lister Shares.....	155
Lister Style Furrowers.....	155

M	
Modular Knife, NH3.....	161
Moldboard Plow Parts.....	137
Moldboard Plow Information.....	121, 130 - 131
Moldboards, Chisel Plow.....	158
Moldboards, Plow.....	137
Mounting Clips, Hammer-Lock.....	136
Mounting Clips, Knock-On.....	136

N	
Neoprene Tubes.....	161
NH3 Knife.....	161
Noble Sweeps.....	156
Notched Edge Disc Blades.....	142 - 143

P	
Peanut Blades.....	154
Planter Gauge Wheel Bearings.....	149
Planter Gauge Wheel Tires.....	149
Planter Gauge Wheels.....	149
Plow Bolts.....	136
Plow Coulters.....	141
Plow Landsides.....	138
Plow Moldboards.....	137
Plow Parts, Moldboard.....	137
Plow Shares.....	138 - 141
Plow Shins.....	137
Plow Wear Pads.....	138
Points, Chisel.....	157 - 158
Points, Drill.....	161
Points, Ripper.....	159
Points, Slash.....	158
Points, Spring Tooth.....	157
Points, Subsoiler.....	159
Points, Wing Sweep.....	156
Poly Shank Savers.....	160
Press Wheel Tires.....	149
Protective Coating Spray.....	136

R	
Ripper Caps.....	159
Ripper Points.....	159
Rippled Coulters.....	141
Rotary Hoe Wheel Bearing.....	159
Rotary Hoe Wheels.....	159
Row Crop Sweeps.....	154

S	
S-Tine Clamps.....	156
S-Tines.....	156
Scrapers, Drill Disc.....	155
Seals, Drill Disc.....	164
Seed Disc Openers.....	162 - 163
Seed Openers.....	162 - 163

S Continued	
Seed Tubes.....	161
Shank Savers.....	136
Shares, Lister.....	155
Shares, Plow.....	138 - 140
Shares, Ribbed.....	138 - 139
Shares, Upset Forged.....	140
Shares, Wing.....	140
Shims, Drill Disc.....	164
Shins.....	132, 137
Shoes, Harrow.....	160
Single Disc Openers.....	163
Slash Points.....	158
Smooth Edge Disc Blades.....	142 - 143
Spacers, Drill Disc.....	164
Special Concavity Disc Blades.....	143
Special Plow Bolts.....	136
Spikes, Alfalfa.....	157
Spikes, Swedged.....	158
Spoons, Air Seeder.....	155
Spring Tooth Points.....	157
Spring Tooth Sweeps.....	157
Steels, Cultivator.....	158
Subsoiler Caps.....	159
Subsoiler Coulters.....	141
Subsoiler Points.....	159
Swedged Spikes.....	158
Sweep Application Charts.....	135
Sweep Terminology.....	133
Sweeps, Alabama.....	154
Sweeps, Chisel.....	156, 157
Sweeps, Chisel Plow.....	156, 157
Sweeps, Danish.....	156
Sweeps, Field Cultivator.....	154
Sweeps, Hammer-Lock.....	155
Sweeps, Joyce.....	154
Sweeps, Knock-On.....	155
Sweeps, Noble.....	154
Sweeps, Row Crop.....	154
Sweeps, Spring Tooth.....	157
Sweeps, Terminator.....	155
Sweeps, Wheatland.....	156, 157
Sweeps, Wing.....	154

T	
Talc Powder.....	153
Technical Information.....	121 - 134
Tender Plant Hoes.....	158
Terminator Sweeps.....	155
Terminology, Disc Blades.....	133
Terminology, Moldboard Plow.....	121 - 132
Terminology, Plow.....	121 - 132
Terminology, Sweeps.....	133
Tines, Danish.....	156
Tines, Rotary Hoe Wheel.....	159
Tires, Gauge Wheel.....	149
Trash Shields, Drill Disc.....	164
Trash Shields, Grain Drill.....	164
Tubes, Fertilizer.....	161
Tubes, Neoprene.....	161
Tubes, Seed.....	161

V	
V-Sweeps.....	154
Vegetable Tools.....	158
Vertical Tillage.....	143

W	
Warranty Policy, Disc Blade.....	133
Washers, Drill Disc.....	164
Wavy Coulters.....	141
Wear Pads.....	138
Wheatland Sweeps.....	156, 157
Wheel Halves, Gauge.....	149
Wheels, Gauge.....	149
Wheels, Hoe.....	159
Wheels, Rotary Hoe.....	159
Wing Shares.....	154
Wing Sweep Points.....	154
Wing Sweeps.....	154

Moldboard Plow Information

Moldboard Plow

The primary purpose of the moldboard plow is to completely turn the soil to a depth of from 5 to 14 inches. This places the residue which was on top of the soil either under the soil or mixed with the soil.

There are two basic types of moldboard plows:

- 1) One way moldboard plow — the original and still most popular plow. Soil is always turned to the right hand side.
- 2) Two way or rollover plow — has two sets of bottoms, $\frac{1}{2}$ being right hand and the other $\frac{1}{2}$ being left hand.

All moldboard plows have three parts in common. The frame, the beam, and the frog. The beam attaches to the frame of the plow and the frog attaches to the beam. The frog and its attached components, the share, shin, landside and moldboard, is the part that engages the soil.

Moldboard Plow Terms

Deep Suck — Penetration point of the plow share that enables the share to "pull" itself into the soil.

Flat-Blade Type Share — Has no deep suck penetration point.

Full Cut Share — Cutting edge extends outwards at both ends of plow share to cut full width that share was designed for.

Narrow Cut Share — Back, or rear cutting edge of plow share cut off "shorter" to cut less than full cut plow was designed for.

Shin — A replaceable extension for the front of the moldboard where the most wear is encountered.

Landside — Heavy steel or cast iron plate bolted to the frog assembly to counteract the natural tendency of the plow to constantly run into the land.

Wear Pad — A piece of steel bolted to the landside wear face that can be reversed and then replaced at less cost than the entire landside assembly.

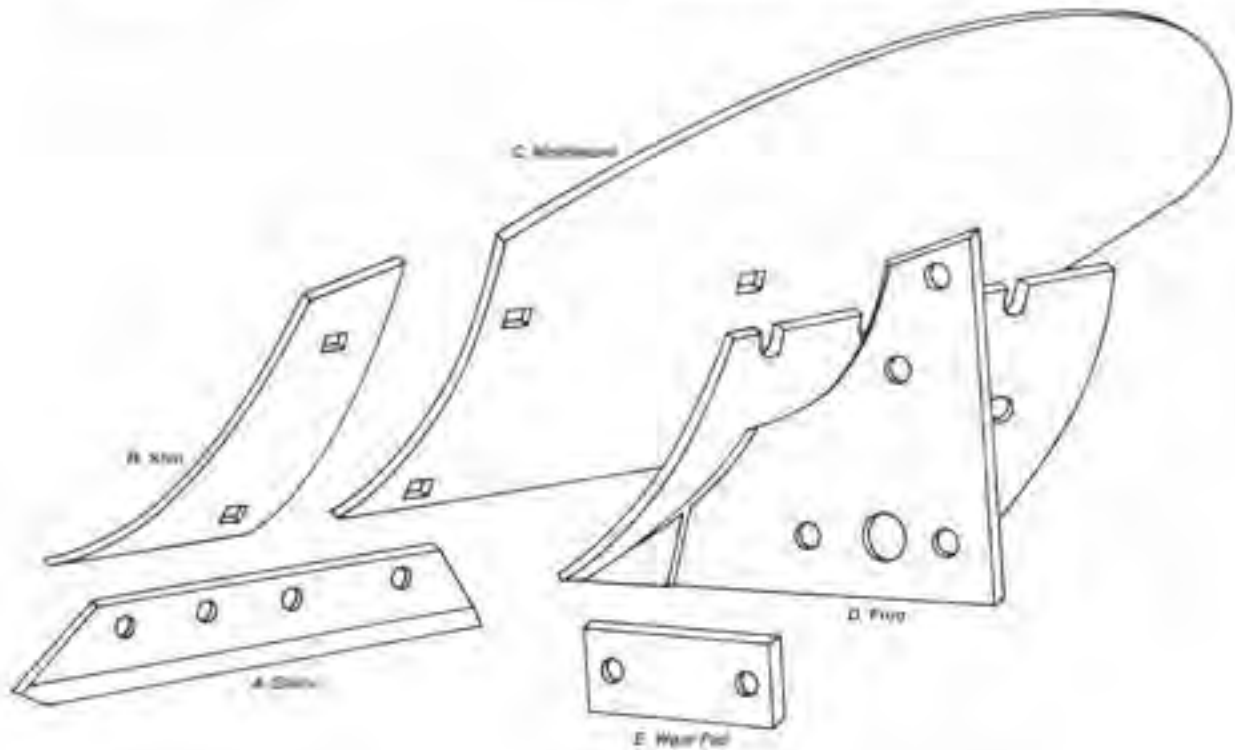

107980 Landside – FORD – Front Landside
 107980 R.H. Shown
 108427 L.H. Opposite
 General Purpose
 Bottom

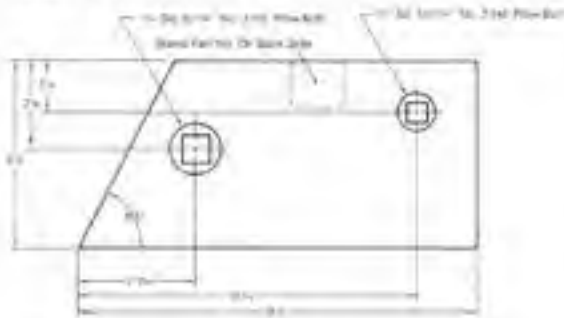

T10856 Landside – CASE PLOWS – Front or Rear
 Landside for EX
 Series Bottoms

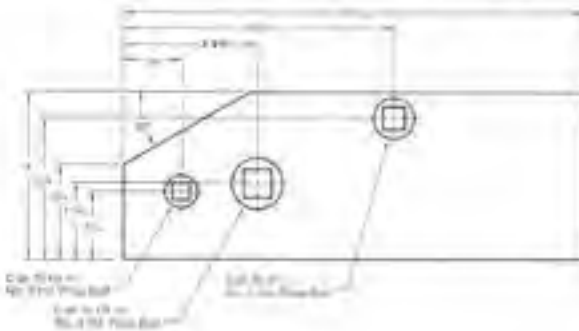

107981 Landside – FORD – Rear Landside
 107981 R.H. Shown
 108429 L.H. Opposite
 General Purpose
 Bottom

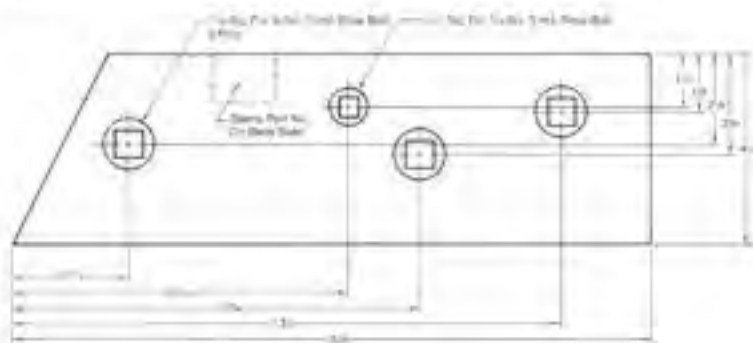

522342 Landside – IHC – "Front" Landside
 Right Hand Shown
 Left Hand Opposite
 Super Chief
 Bottom



522343 Landside – IHC – "Rear" Landside
 Right Hand Shown
 Left Hand Opposite
 Super Chief
 Bottom

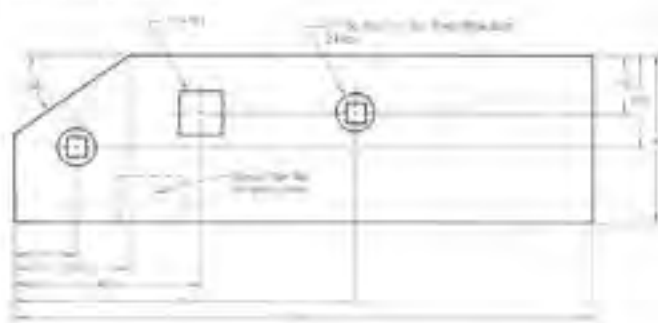

TILLAGE

A16493 Landside – JOHN DEERE
 Front or Rear Landside for all "HS" or "NU" Series
 Plow Bottoms. Use with AA 15262 Wear Pad.
 A16493 R.H. Shown
 A16494 L.H. Opposite

AA15262 Wear Pad/Heel - JOHN DEERE HS & NU
 AA15262 R.H. Shown
 AA15263 L.H. Opposite

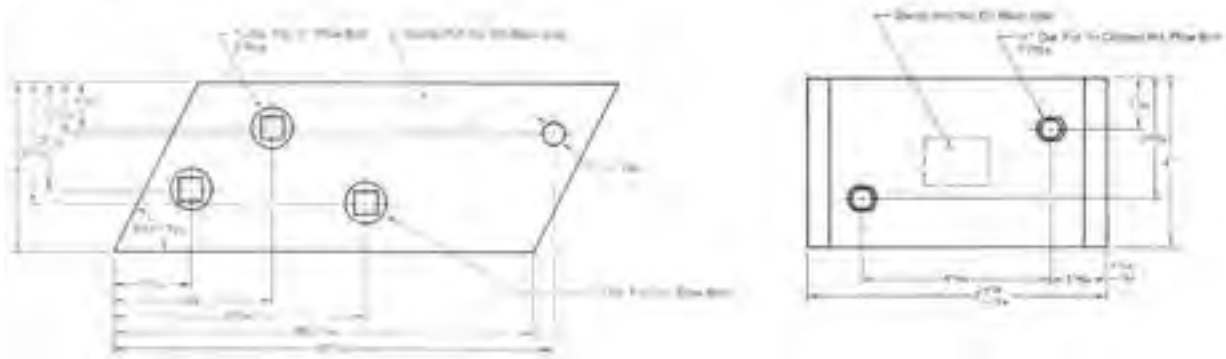

660003 Landside – MASSEY-FERGUSON – "Rear" Landside for "N" – "N-Heavy Duty" Bottom

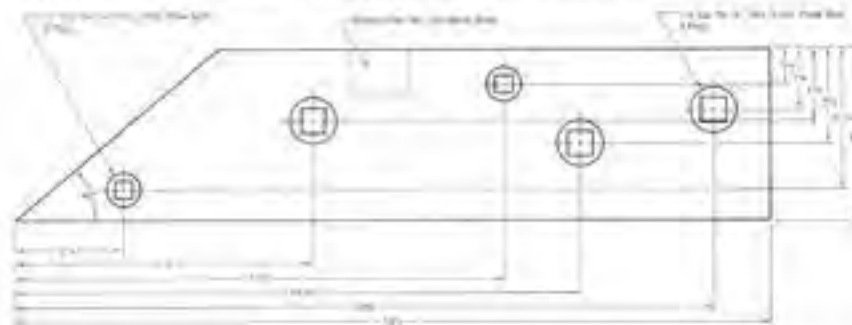

495937 Landside – MASSEY-FERGUSON – Front or Rear Landside for "N" Heavy Duty & High Speed use in conjunction with Deere AA 15262 wear pad

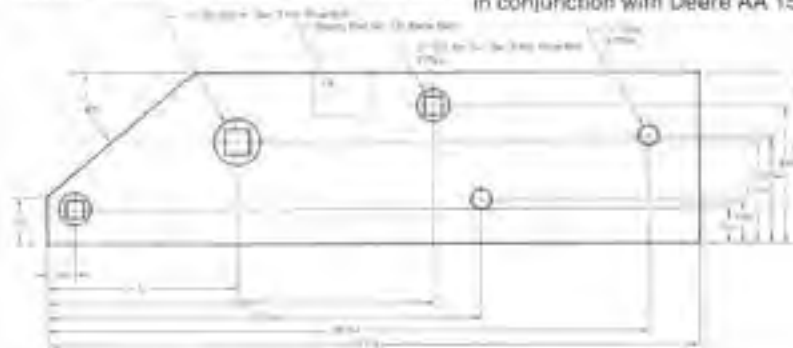

660002 Landside – MASSEY FERGUSON – Front Landside for "N" and "N-Heavy Duty" Bottom.

660002 R.H. Shown
 661560 L.H. Opposite

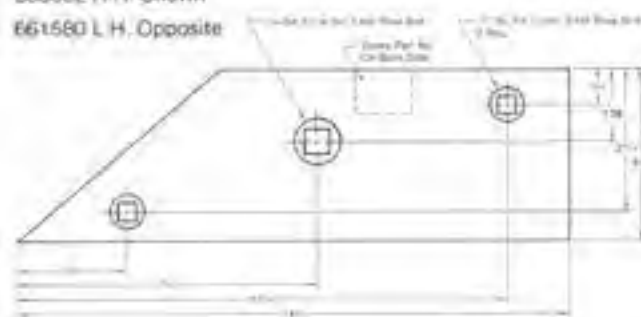

TILLAGE

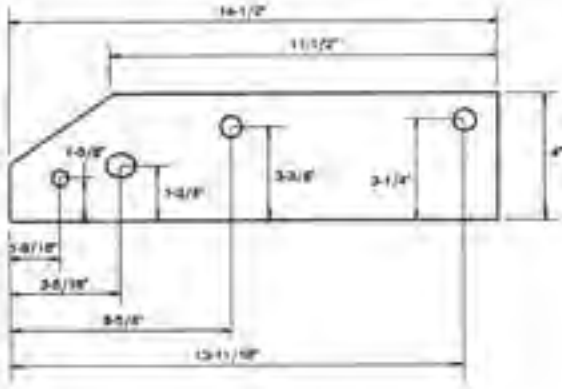

T51968 OFFSET LANDSIDE
 3/8 X 1-1/2-5/8 X 2-1/2 - 1/2 X 2-1/4-7/16 X 1-1/2

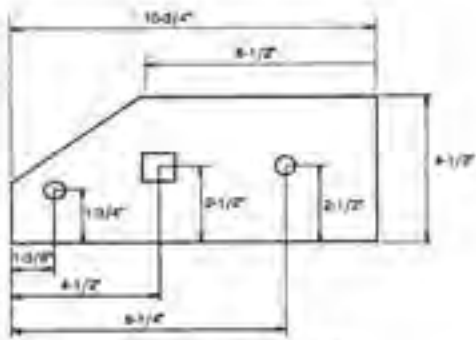

489465 RH LANDSIDE
542417 LH LANDSIDE
 7/16 X 1-3/4 - 7/16 X 1-3/4

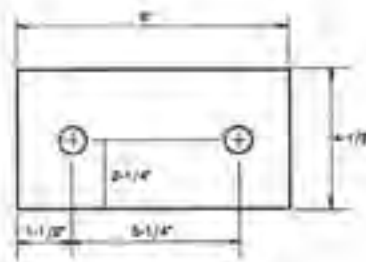

A27862 LANDSIDE
 5/8 X 3-1/2-5/8 X 3-1/2

ALLIS CHALMERS

FORD

AM16-4RS

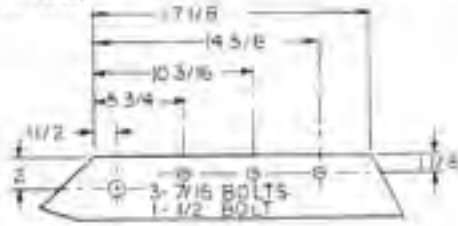

AM18-4RS

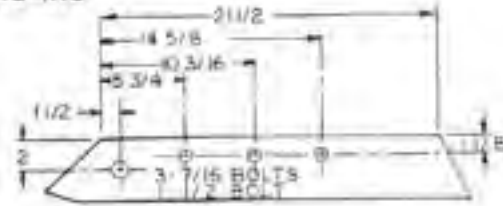

FF14-3RS

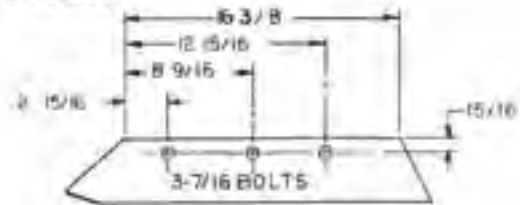

FF16-3RS

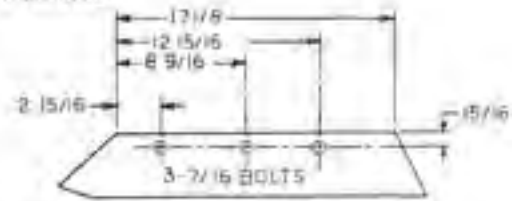

FF14-4RS

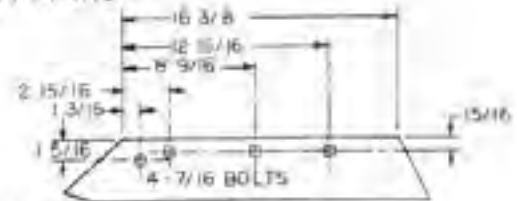

FF16-4RS
FF16-4LRS

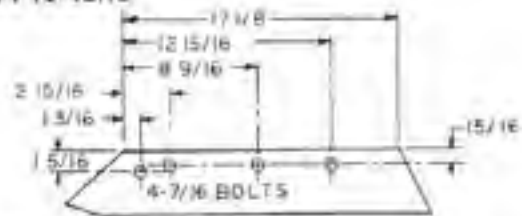

FF18-5RS

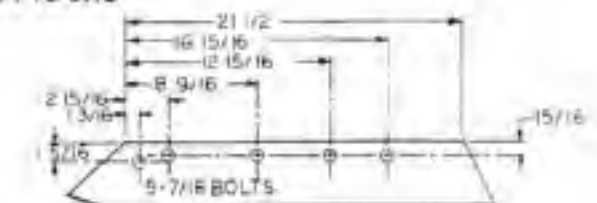

TILLAGE

IHC

MI14-3RS

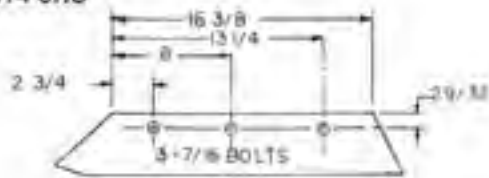

MI16-3RS

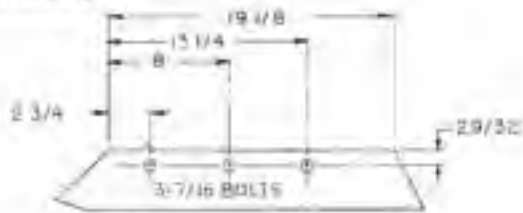

IH14-4RS

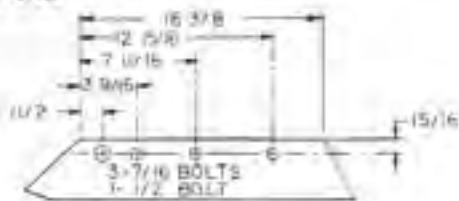

IH16-4RS
IH16-4LRS

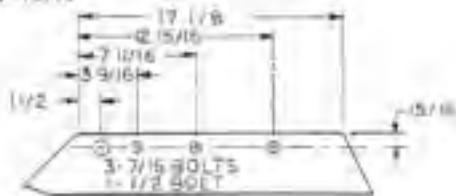

IH18-4RS
IH18-4LRS

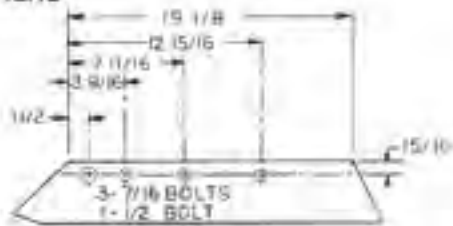

J. I. CASE

CA16-3RS

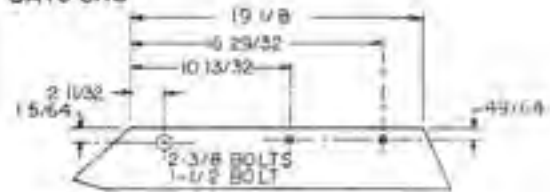

CA16-4RS
CA16-4LRS

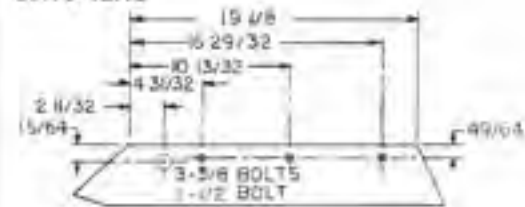

JOHN DEERE

JD14-3RS

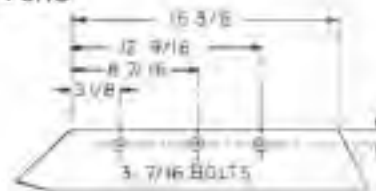

JD16-3RS



JD14-4RS

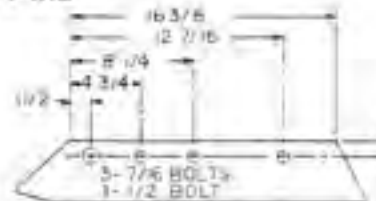

JOHN DEERE

JD16-4RS
JD16-4LRS

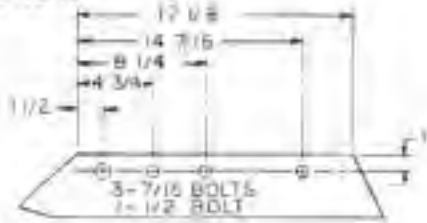

JD18-5RS
JD18-5LRS

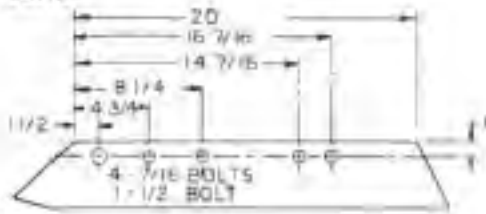

JD18-3RS

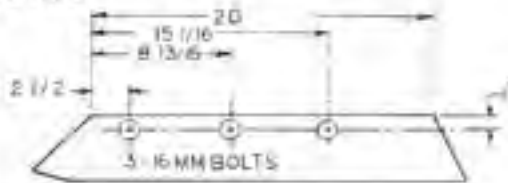

MASSEY FERGUSON

MI14-3RS

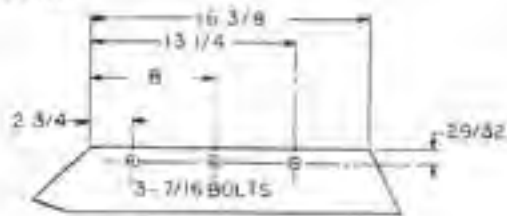

MI16-3RS

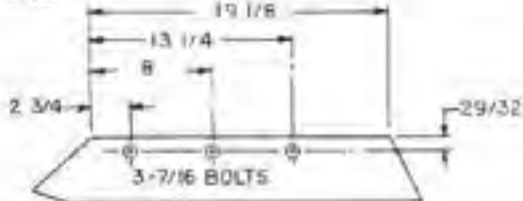

MF14-4RS

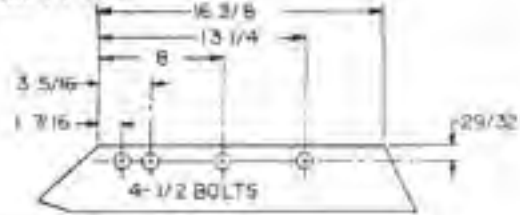

MF16-4RS
MF16-4LRS

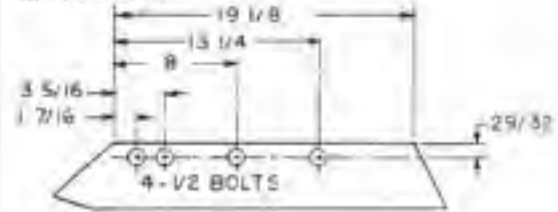

MF18-4RS
MF18-4LRS

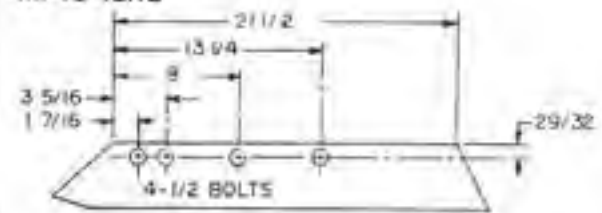

MELROE

MM14-4RS

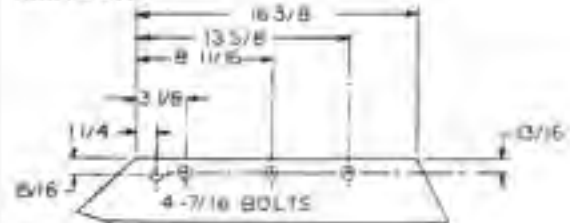

MM16-4RS

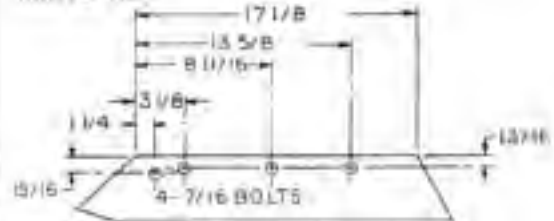

TILLAGE

MM18-4RS

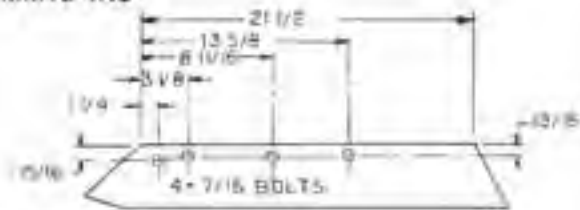

MR16-4RS

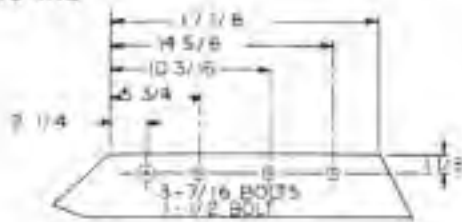

MR18-4RS

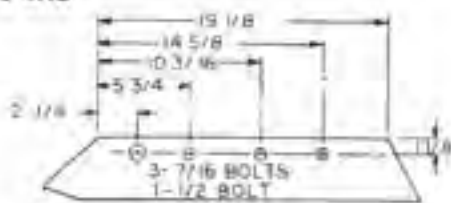

OLIVER-WHITE-M&M

OM14-4RS

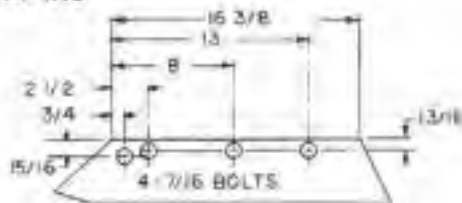

OM16-4RS
OM16-4LRS

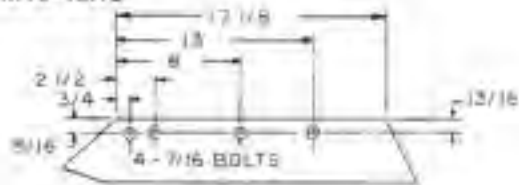

OM18-5RS
OM18-5LRS

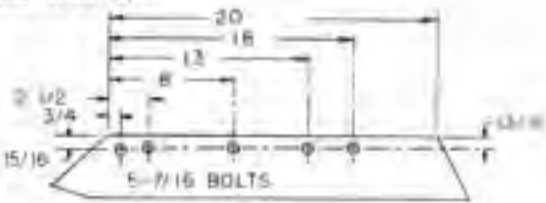

OC16-4RS
OC16-4LRS

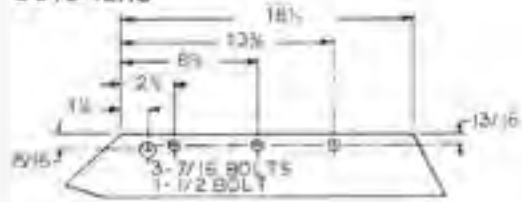

OC18-5RS
OC18-5LRS

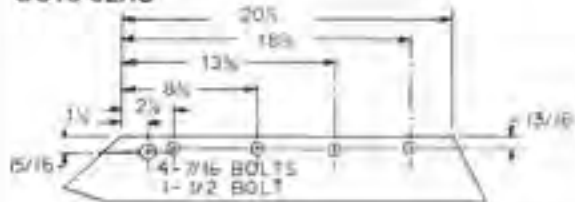

OC20-5RS

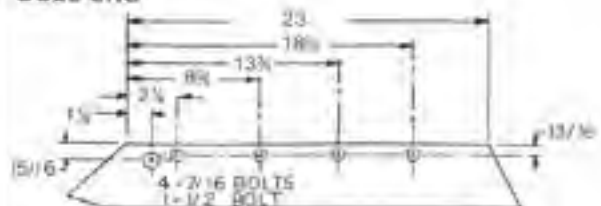

OD18-5RS

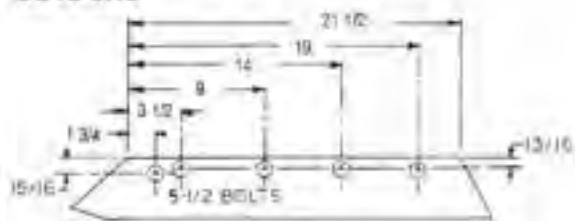

TILLAGE

WATTS

WA18-4RS

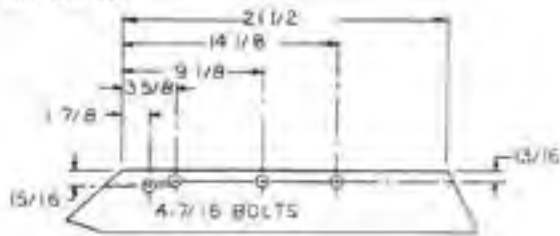

WIL-RICH

WR18-4RS

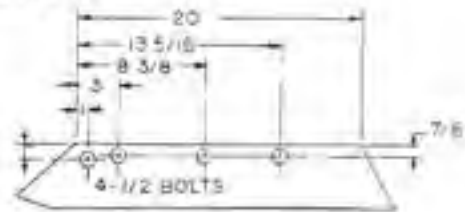

BAKER

BA25-6RS



HARRELL

HA24-5RS

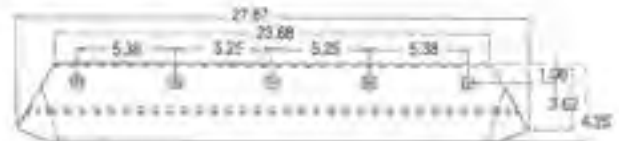

JOHN DEERE

JD24-4RS

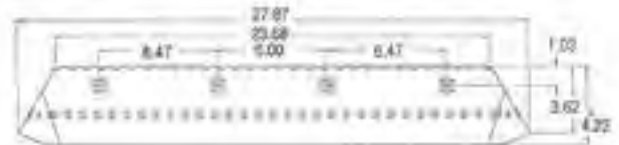

ALLIS CHALMERS

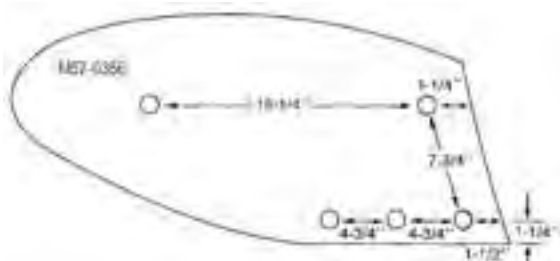

FORD

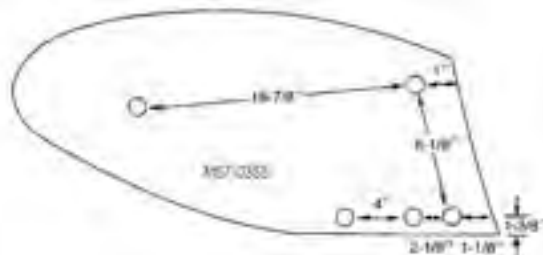

JOHN DEERE

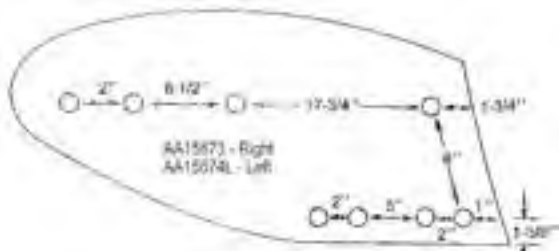
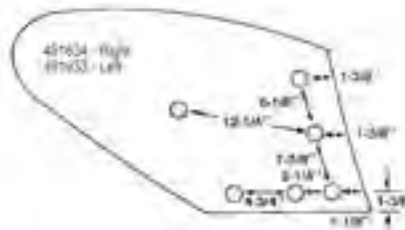
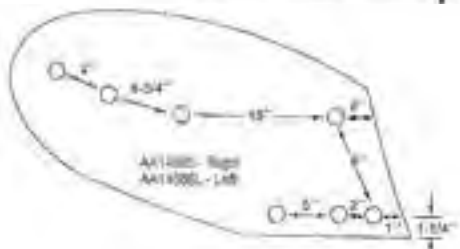
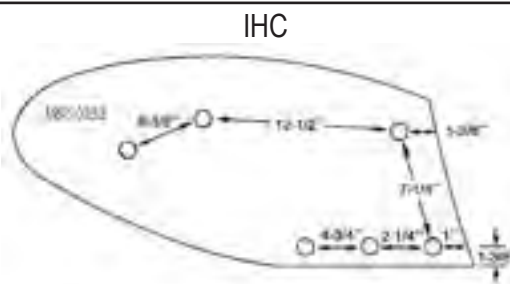
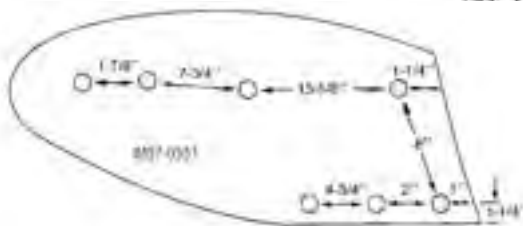
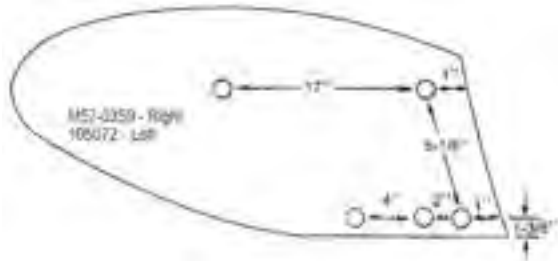
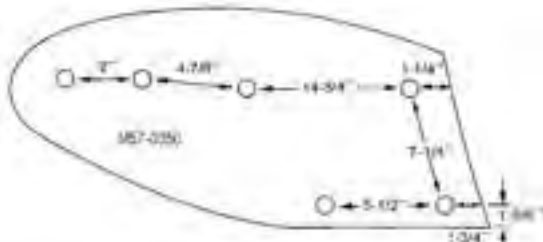

MASSEY FERGUSON

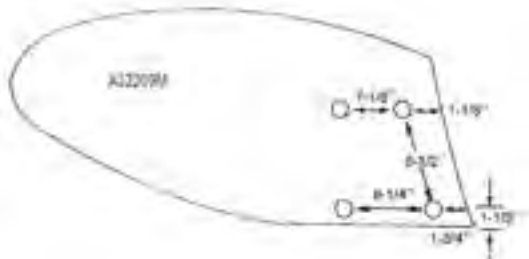
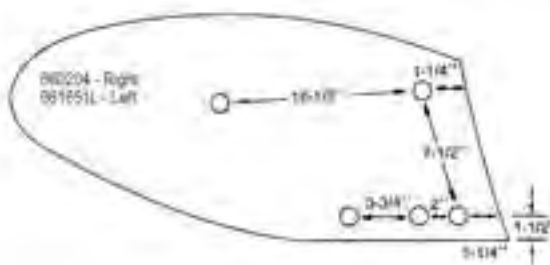

TILLAGE

OLIVER/WHITE

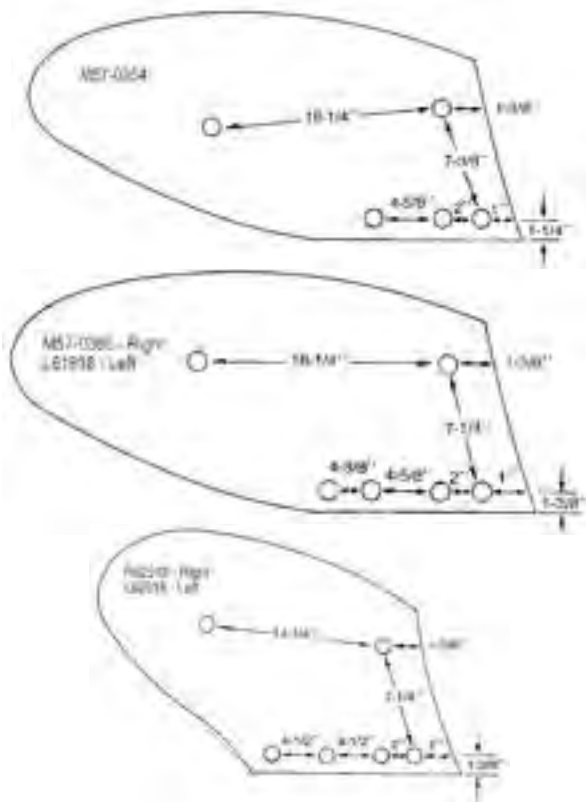

JOHN DEERE

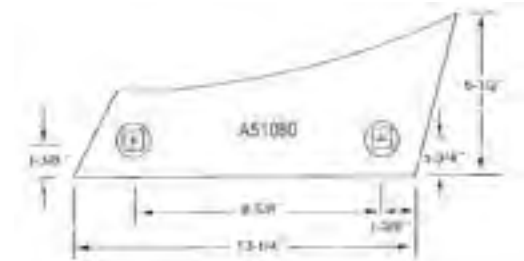
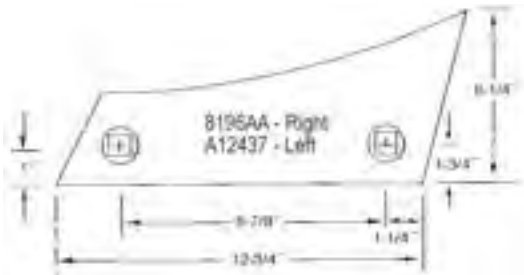
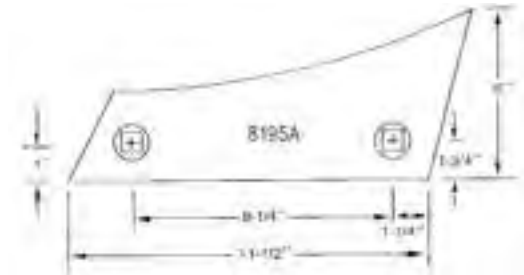
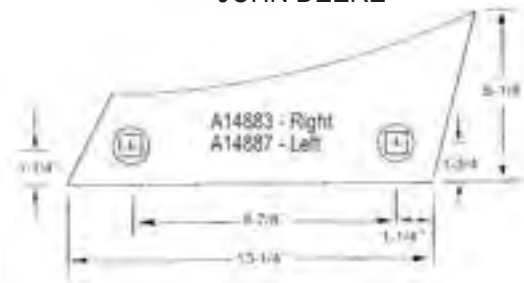

SHINS

ALLIS CHALMERS

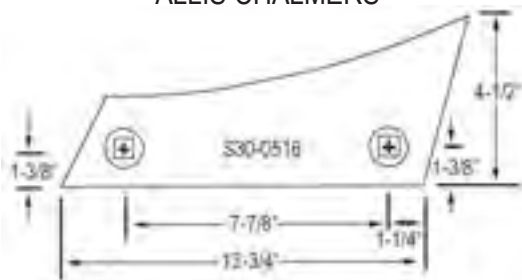

CASE

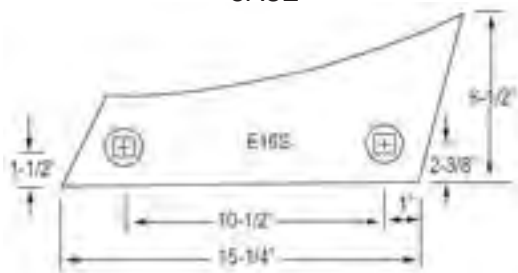

FORD

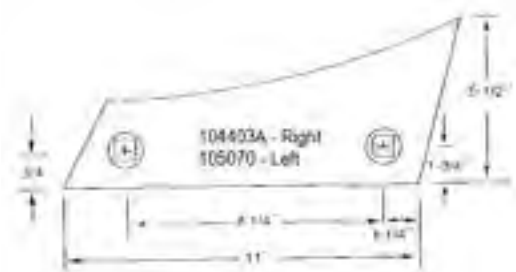

TILLAGE

IHC

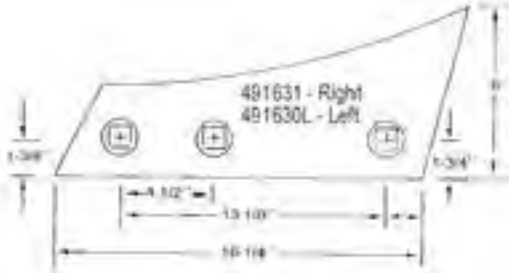
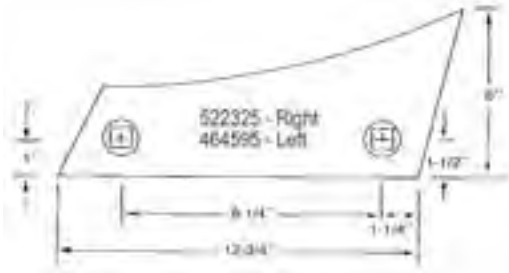

MASSEY FERGUSON

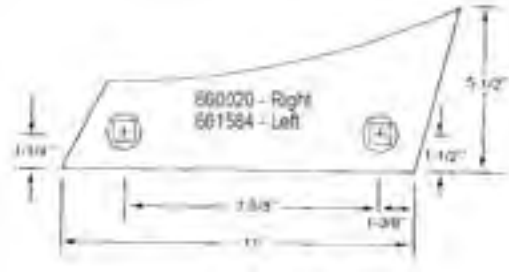

OLIVER/WHITE

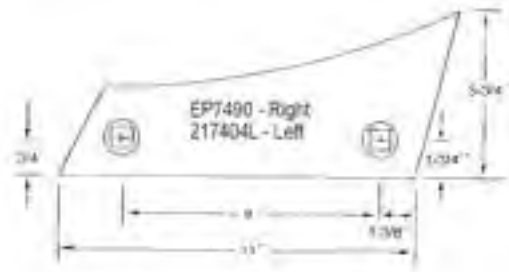

TILLAGE

SWEEP TERMINOLOGY

- A. **Point Suck** - Concentrated soil penetration point of the sweep. Manufactured on a lower horizontal plane than the wings to provide increased soil penetration.
- B. **Bevel** - Edges of wings are forged in a press so the sweep self-sharpens with field use.
- C. **Stem Angle** - Refers to the angle the sweep shank forms with the horizontal plane of the ground. Determines the depth of soil penetration.
- D. **Size** - Refers to the distance between the two outside edges of the wings of a sweep.
- E. **Crown** - The distance from the ground to the tip of the wing and lower bolt hole measured on a level plane. These measurements determine the volume of dirt that the sweep will go through. We offer low and medium crown sweeps.

DISC BLADE TERMINOLOGY

Normal Concave

Recommended in light soils and in rocky fields to control soil movement. In rocky conditions, they reduce stress loads on the frame and gang components. In other soil types, especially with 7 1/4 to 9 inch blade spacing, concave blades also may be your choice for general purpose disking and chemical incorporation.

John Deere Design Conical

Recommended for medium and heavy soils for more aggressive cutting and mixing action. May also penetrate better than spherical blades.

Case - IH Design Flat Back

Offered as replacement for O.E.M. blade. Same cutting and soil movement action as a normal concave disc.

Miller (New Holland) Design Special

Offered as replacement for O.E.M. blade. These blades feature a special shallow concavity.

Plain Disc

Recommended for most tillage applications.

Notched Disc

Improves penetration in hard ground and slicing action in heavy residue.

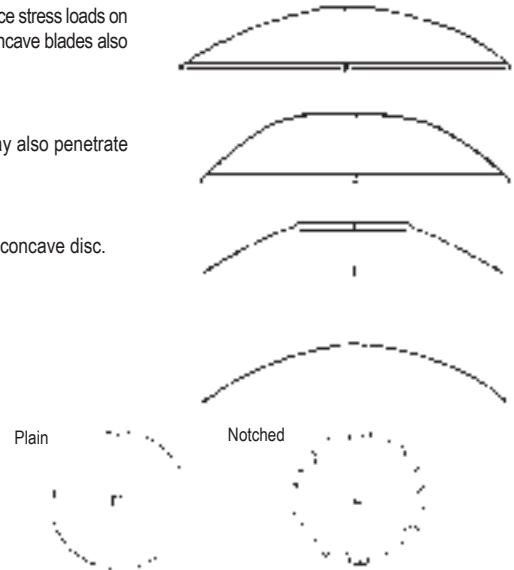

DISC BLADE WARRANTY POLICY

Note: Disc Blades carry 100% warranty on edge breakage or bending up to 1" in diameter wear.



No Credit

Irregular breaks or disc blade fracture resulting from overloading in rock or stump conditions or other solid objects.



Full Credit

Straight directional break due to defective material.



No Credit

Irregular breaks or disc blade fracture resulting from overloading in rock or stump conditions or other solid objects.



Full Credit

Laminated or split, caused by defective material.



No Credit

Center broken out caused by either implement design fault, excessive draft, excessive flexing of disc or loose gang bolts in rock or stump conditions.

Disc Model No.	Axle Size
Allis Chalmers	
2100-2300	1 1/2 Square
3400	1 1/2 Round
Amco	
WOD, WTD	1 1/8 Square
WOE	1 3/8 Round
WOR, WOJ	1 1/2 Square
WTF, WTJ	1 1/2 Square
48, 85, 148, 185, 248, 258	
F15B & F15	1 1/2 Square
Athens	
48	1 Square
62	1 1/8 Square
126	1 1/2 Square
131	1 1/2 Square
Binkley	
700 Series	1 1/2 Round
Blanton	
4500	1 1/2 Square
B900	1 1/8 Square
B1000	1 1/8 Square
3000H	1 1/2 Square
Burch	
Kwik-Set	1 1/8 Square
209	1 1/8 Square
208 BW	1 1/2 Round
Tru-Cut	7/8 Square
Bush-Hog	
245	1 1/4 or 1 1/2 Square
1440	1 1/8 Square
1445	1 1/8 or 1 1/4 Square
1450	1 1/8 or 1 1/4 Square
145	1 1/4 Square
146 Reg	1 1/4 Square
146 HD	1 1/2 Square
1422	1 or 1 1/8 Square
1424	1 1/8 Square
1432	1 1/8 Square
1436	1 1/8 Square
1437	1 1/8 or 1 1/2 Square
1438 & 1439	1 1/8 Square
1444	1 1/8 Square
Rolling Bedder	1 1/8 Square
Dunham Lehr	
GC	1 1/8 Square
Ford	
201	1 Round
202	1 Round
204	1 Round
219	1 1/2 Square
220	1 1/8 Square
221	15/16 Round
222	1 1/8 Square
236	1 1/2 Square
243	1 1/2 Round
Hesston	
2410	1 3/4 Round

Disc Model No.	Axle Size
International Harvester	
122, 132, 350, 370	1 1/8 Square
400, 470	1 1/8 Square
490	1 1/8 Square
500	1 1/2 Square
610	1 1/2 Square
630	1 1/2 Round
John Deere	
105	1 Round
115	1 1/8 Round
225	1 1/2 Round
425	1 1/2 Round
1630	1 1/2 Square
100	1 1/8 Square
110	1 1/8 Square
200 & 210	1 1/8 Square
215	1 1/2 Round
220	1 1/8 Square
225	1 1/2 Round
230 (Cone Disc)	1 1/8 Square
235	1 1/8 & 1 1/2 Round
310	1 1/4 Square
425	1 1/2 Round
525	1 1/2 Round
1630 & 1635	1 1/2 Square
1640	1 1/2 Square
2620 (Cone Disc)	1 1/2 Square
2621	1 1/2 Square
2650	1 3/4 Square
2651	1 3/4 Square
2700	2 1/4 Square
BWA	1 1/4 Square
BWF	1 1/4 Square
Kewanee	
800	1 1/8 Square
1000	1 1/8 Square
Krause	
1952-1956-60-70	1 1/2 Round
1959-63-73	
1968-1969-1979	1 1/2 Round
1965-1966-1976	1 1/2 Round
2100 Series	1 1/2 Round
2200 Series	1 1/2 Round
2400 Series	1 1/2 Round
2400 Series	1 3/4 Round
3100 Series	1 1/2 Round
3200 Series	1 3/4 Round
1498 & 1499	1 1/2 Round
1465-1470	1 3/4 Round
1580-1480	1 1/2 Round
1710-1769	1 3/7 Round
1912-1915-1918	1 1/2 Round
1901-1904-1907	1 1/2 Round
1922-1925-1928	1 1/2 Round
1921-1924-1927	1 1/2 Round
1959-1963-1973	1 1/2 Round
Long	
953	7/8 Square
1080	1 1/2 Square
1087, 88, 89	1 1/2 Square

Disc Model No.	Axle Size
Massey Ferguson	
MF520, 620, 820	1 1/4 Square
MF21	1 Square
MF30, 720	1 1/2 Square
MF25, 39	1 Round
MF40	1 1/2 Square
MF52	1 1/8 Square
MF72	1 1/8 Round
Miller	
Series I	1 3/4 Round
Series II	1 3/4 Round
New Holland	
OD100	1 3/4 Round
OD200	1 3/4 Round
OD300	2 Round
TD100	1 3/4 Round
TD200	1 3/4 Round
Rhino	
177	1 1/2 Square
Flex 90	1 1/8 Square
Flex 90B	1 1/4 Square
Sunflower	
1210	1 1/2 Round
1211	1 3/4 Round
1230	1 1/2 Round
1231	1 3/4 Round
1320 & 1330	1 3/4 Round
1321 & 1331	1 3/4 Round
1430 & 1440	1 3/4 Round
H-3 & H-4	1 3/4 Round
1431-1441	1 3/4 Round
1541	
Schafer	
355	1 3/4 Round
555	2 Round
Taylor Way	
200251 thru 200268	1 1/2 Square
200108 thru 200118	1 1/8 Square
20023	1 1/8 Square
20024	1 1/8 Square
200196-200199	1 1/8 Square
2000051-2000068	1 1/8 Square
200284-200291	1 1/2 Square
200310-200315	1 1/2 Square
2001 Series	1 1/8 Square
200011	7/8 Square
200013	7/8 Square
200035	1 1/8 Square
200036	1 1/8 Square
200037	1 1/8 Square
200048	1 1/8 Square
200049	1 1/8 Square
2000165	7/8 Square
2000166	7/8 Square
2000167	7/8 Square
Vasser	
Disc-Ezy	1 1/8 Square
White	
251	1 1/8 Square
252	1 1/8 Square
253	1 1/8 Square
263	1 1/8 Square
265	1 1/8 Square
271,272	1 1/8 Square
281	1 1/2 Square

CHISEL PLOW (WHEATLAND) SWEEPS

Application	Bolt Size *	Hole Spacing	Stem Angle
Allis Chalmers 22" - 32" (now Deutz-Allis)	7/16" R	2 1/4" - 2 1/2"	43°
Anderson	7/16" R	2 1/4" - 2 1/2"	50°
Brady	7/16" R	2 1/4" - 2 1/2"	50°
Case (Later Models)	7/16" R	2 1/4" - 2 1/2"	50°
Case-IH	7/16"	2 1/4" - 2 1/2"	43°
C.C.I.L. 1" Thick Shank	7/16" R	2 1/4" - 2 1/2"	50°
C.C.I.L. 1 1/4" Thick Shank	1/2"	2 1/4" - 2 1/2"	43°
Cockshutt 240, 246, 247, 476, 249	7/16" R	2 1/4" - 2 1/2"	50°
Crown	1/2"	2 1/4" - 2 1/2"	50°
DMI	1/2"	2 1/4" - 2 1/2"	50°
Dengelmen	7/16" R	2 1/4" - 2 1/2"	50°
Edwards	7/16" R	2 1/4" - 2 1/2"	50°
Flexi-Coil (2" x 1" Shank)	1/2"	2 1/4" - 2 1/2"	50°
Ford 131	7/16" R	2 1/4" - 2 1/2"	50°
Friggstad	7/16" R	2 1/4" - 2 1/2"	50°
Glencoe (High Clearance)	7/16" R	2 1/4" - 2 1/2"	50°
Graham (High Clearance)	7/16" R	2 1/4" - 2 1/2"	50°
Hiniker	1/2"	2 1/4" - 2 1/2"	50°
IHC 10, 50, 55, 75, 64 S	7/16" R	2 1/4" - 2 1/2"	43°
Ingham	1/2"	2 1/4" - 2 1/2"	43°
Jeoffery 16"	7/16" R	2 1/4" - 2 1/2"	50°
Jeoffery 22" - 32"	7/16" R	2 1/4" - 2 1/2"	43°
John Deere	7/16" R	2 1/4" - 2 1/2"	50°
Kewanee	7/16" R	2 1/4" - 2 1/2"	50°
Killbery	7/16" R	2 1/4" - 2 1/2"	50°
Krause (High Clearance)	7/16" R	2 1/4" - 2 1/2"	50°
Leon	1/2"	2 1/4" - 2 1/2"	50°
Massey Harris	7/16" R	2 1/4" - 2 1/2"	43°
Massey "Trash King"	7/16" R	2 1/4" - 2 1/2"	50°
Mel-Cam	7/16" R	2 1/4" - 2 1/2"	50°
Mel-Cam Cultivator	7/16" R	2 1/4" - 2 1/2"	43°
Minneapolis Moline T600, 1500, 1800	7/16" R	2 1/4" - 2 1/2"	50°
Minn-Toba 120, 176	7/16" R	2 1/4" - 2 1/2"	50°
Minn-Toba 3 Point Hitch	7/16" R	2 1/4" - 2 1/2"	43°
Mohawk	1/2" R	2 1/4" - 2 1/2"	43°
Morris 220	7/16" R	2 1/4" - 2 1/2"	43°
Morris MP 912 & Magnum	1/2"	2 1/4" - 2 1/2"	50°
Noble XR-20	7/16" R	2 1/4" - 2 1/2"	50°
Oliver	7/16" R	2 1/4" - 2 1/2"	43°
Robin/Nodwell	7/16" R	2 1/4" - 2 1/2"	50°
Rogin	7/16" R	2 1/4" - 2 1/2"	50°
Roll-O-Cone	1/2"	2 1/4" - 2 1/2"	50°
Roll-O-Flex	7/16" R	2 1/4" - 2 1/2"	50°
Schulte 300	1/2"	2 1/4" - 2 1/2"	50°
Sunflower	7/16" R	2 1/4" - 2 1/2"	50°
Versatile	7/16" R	2 1/4" - 2 1/2"	50°
Victory	7/16" R	2 1/4" - 2 1/2"	50°
Wil Rich	1/2"	2 1/4" - 2 1/2"	43°

* (R) In some instances our inventory reducer bolt (7/16" bolt w/1/2" head) is required.

FIELD CULTIVATOR SWEEPS

Application	Bolt Size	Hole Spacing	Stem Angle
Allis Chalmers (now Deutz-Allis)	(2) 7/16"	2"	54°
Allis Chalmers 1200, 1300	3/8"	N/A	N/A
Anderson	(2) 3/8"	1- 3/4"	47°
Baker	(2) 3/8"	1- 3/4"	41°
Becker/ATI	3/8"	N/A	N/A
Ber-Vac	3/8"	N/A	N/A
Bourgault	(2) 7/16"	1- 3/4"	47°
Brady (Prior to '70-'71)	(2) 3/8"	1- 3/4"	47°
Brady (After '70-'71)	7/16"	1- 3/4"	47°
Buckeye	3/8"	N/A	N/A
Bush Hog	(2) 3/8"	1- 3/4"	47°
Calkins	(2) 3/8"	1- 3/4"	47°
Case F.C., F.C.M., F.C.S.W.	(2) 3/8"	1- 3/4"	47°
C.C.I.L.	(2) 3/8"	1- 3/4"	47°
Cockshutt 285, 485	(2) 3/8"	1- 3/4"	47°
Crustbuster	(2) 7/16"	1- 3/4"	47°
Flexi-Coil 200, 400 Series	(2) 7/16"	1- 3/4"	47°
Ford 208	(2) 3/8"	1- 3/4"	47°
Frontier	(2) 7/16"	1- 3/4"	47°
Glencoe, F.C., M.F.C., F.C.S.W.	(2) 3/8"	1- 3/4"	47°
Note: Row Crop Cultivator Uses Same Sweep			
Glencoe Soil Finisher	3/8"	N/A	N/A
Hesston	(2) 7/16"	1- 3/4"	47°
Hiniker	(2) 7/16"	1- 3/4"	47°
IHC & Case IH	(2) 7/16"	1- 3/4"	47°
Deere 1000 Series	(2) 3/8"	1- 5/8"	41°
Deere CCA, C10, C20	3/8"	1- 3/4"	41°
Deere 960-FC	(2) 7/16"	1- 3/4"	47°
Kent	(2) 7/16"	1- 3/4"	47°
Kewanee	(2) 7/16"	1- 3/4"	47°
Koehn	3/8"	N/A	N/A
Kongskilde	3/8"	N/A	N/A
Krause 600/900	(2) 3/8"	1- 3/4"	47°
Landoll	(2) 7/16"	1- 3/4"	47°
Massey Ferguson 160	(2) 3/8"	1- 3/4"	47°
Minneapolis Moline FT200	(2) 3/8"	1- 3/4"	47°
Morris L240, L320	(2) 3/8"	1- 3/4"	47°
Noble Mix-N-Till	3/8"	N/A	N/A
Oliver 245, 345	(2) 3/8"	1- 3/4"	41°
Oliver 285, 385, 485	(2) 3/8"	1- 3/4"	47°
Rhino/Athens	(2) 7/16"	1- 3/4"	47°
Sunflower	7/16"	1-3/4"	47°
Taylor	(2) 3/8"	1- 3/4"	47°
Unverferth Culti-System	3/8"	N/A	N/A
Vicon/McKee	3/8"	N/A	N/A
Wil Rich	(2) 7/16"	1- 3/4"	47°
Win Power 1500	(2) 7/16"	1- 3/4"	47°
White Farm Equipment	(2) 3/8"	1- 3/4"	47°
Glencoe (old) 1250 "Double Shank"	(2) 3/8"	1- 3/4"	41°

#3 HEAD PLOW BOLT WITH NUT

- Right Hand, #3 • Grade 5

B55-0220



Size	Pkg. Qty.	Order No	Price
3/8" x 1"	50	B55-0220	
3/8" x 1-1/4"	50	B55-0225	
3/8" x 1-1/2"	50	B55-0230	
3/8" x 1-3/4"	50	B55-0235	
3/8" x 2"	50	B55-0240	
3/8" x 2-1/2"	50	B55-0245	
7/16" x 1"	50	B55-0250	
7/16" x 1-1/4"	50	B55-0255	
7/16" x 1-1/2"	50	B55-0260	
7/16" x 1-3/4"	50	B55-0265	
7/16" x 2"	50	B55-0270	
7/16" x 2-1/4"	50	B55-0274	
7/16" x 2-1/2"	50	B55-0280	
7/16" x 3"	50	B55-0285	
1/2" x 1-1/4"	25	B55-0290	
1/2" x 1-1/2"	25	B55-0295	
1/2" x 2"	25	B55-0300	
1/2" x 2-1/2"	25	B55-0305	
1/2" x 3"	25	B55-0310	
5/8" x 2"	25	B55-0315	
5/8" x 2-1/2"	25	B55-0320	
5/8" x 3"	25	B55-0325	
5/8" x 3-1/2"	25	B55-0330	

• Sold in package quantities only.

INDIVIDUAL BOLTS/NUTS

Size	Order No.	Price
3/8" x 1"	A 484121	
3/8" x 1-1/4"	A 527846	
3/8" x 1-1/2"	A 484154	
3/8" x 1-1/2" with 7/16" head	A 486449	
3/8" x 2"	A 486498	
7/16" x 1-1/4"	A 484089	
7/16" x 1-1/2"	A 527853	
7/16" x 1-3/4"	A 527812	
7/16" x 2"	A 527796	
7/16" x 3"	A 486225	
1/2" x 2-1/2"	A 483719	
1/2" x 3"	A 527838	
5/8" x 3-1/2"	A 486258	

SPECIAL PLOW BOLTS

- Right Hand
- Inventory Reducing
- Right hand, #3
- Grade 5
- Nuts Included



Used on Plowshares, Landsides and More!

Size	Pkg. Qty.	Order No	Price
3/8" x 1-1/2" w/7/16" Head	50	716381550P	
7/16" x 2-1/2" w/1/2" Head	50	127162550P	

CLIPPED HEAD BOLTS

- Right hand or left hand
- Grade 5
- Nuts included



B55-0505

Size	Pkg. Qty.	Order No	Price
3/8" x 1-3/16, RH	50	B55-0505	
7/16" x 1-1/4", RH	50	7161450C	
7/16" x 1-1/4" LH	50	B55-0560	
7/16" x 1-1/2", RH	50	B55-0515	
7/16" x 1-3/4", RH	50	B55-0520	
1/2" x 1-1/4", RH	25	B55-0525	
1/2" x 1-3/8" LH	25	B55-0565	
1/2" x 1-1/2", RH	25	B55-0530	
16 mm x 35 mm Metric, RH	50	MI6350C	

INDIVIDUAL CLIPPED HEAD BOLTS

Size With Nuts	Order No.	Price
3/8" x 1-1/4"	A 527770	
7/16" x 1-1/4"	A 527788	
1/2" x 1-1/4"	A 483610	

Front Bolt For Rock Share	Order No.	Price
3/8" x 1-1/2"	A 483677	
7/16" x 1-1/2"	A 527843	
1/2" x 1-1/2"	A 527861	

UNIVERSAL COVERING CHAIN

Made of heavy gauge steel. Welded 3-ring construction.



Order No	Price
C30-0050	

PROTECTIVE PLOW COAT

A non-drying, low-gloss coating for use as temporary protection over tillage tools. Use on plow bottoms, disk blades, sweeps and shovels for protection against rust and corrosion. The soft coating will scour clean quickly when the implement is put into service. 12 oz. aerosol can.



Order No	Price
A 972509	

ELLIPTICAL HEAD BOLTS

- Right Hand H10
- Grade 5
- Nuts Included



Size	Pkg. Qty.	Order No	Price
3/8" x 1-1/2"	50	381550E	

CHROME PLATED PLOW BOLTS

- Right Hand



Size	Pkg. Qty.	Order No	Price
1/2" x 1-1/2"	25	B55-0198	
1/2" x 2"	25	B55-0199	

TILLAGE

MOUNTING CLIPS FOR HAMMER-LOCK SWEEPS

Install Clip Only Once When Using Hammer-Lock Designed Sweeps. Use #3 Plow Bolt.

C45-0407



Replaces Number	Bolt Size	Hole Spacing	Order No	Price
LKM-6	3/8"	1-5/8" to 1-3/4" Slotted	C45-0407	
LKM-7	7/16"	1-3/4" to 2" Slotted	C45-0408	

SHANK SAVERS - POLY



Size/ Application	Hole Spacing	Bolt Size	Box Qty.	Order No	Price
1-3/4" x 9" x 1/4"	1-5/8" to 2"	3/8"-7/16"	100	P44-0360	
Field Cultivators					
2" x 10" x 1/4"	2-1/4" to 2-1/2"	7/16"-1/2"	100	P44-0361	
Chisel Plows					
V-Blade Guard			Each	20010085	

MOLDBOARDS Made In The USA



- Heat-Treated
- Sold Individually
- Painted Black Finish
- 1080 High Carbon Steel
- Solid Construction, 5/16" thick
- Moldboards Require:
(5) Grade 5 #3 Plow Bolts
7/16" Dia. x 1" or 1-1/2 Long

Manufacturer	Models	Size	Mfg. No.	Order No.	Price
Allis Chalmers	387 Series	14, 16", 18"	347966	M57-0356	
DMI	Hydrawide	16", 18"	33111601	M57-0353	
Ford	General Purpose	14"	104409	M57-0358	
Ford	General Purpose	16"	104412-HB	M57-0359	
Ford	General Purpose	18"	R619-18HB	M57-0360	
Harrell	Switch Plow	24"	7921736	A7901236	
International	Super Chief (High Speed). Right Hand	16", 18"	462314R, 488265R, 58996C	M57-0352	
International	Super Chief (High Speed). Left Hand	16", 18"	464603	464603	
John Deere	HS314, HS324, HS354, HS434, HS444	14"	A20700	M57-0350	
John Deere	HS316, HS326, HS356, HS436, HS446	16"	A20702	M57-0351	
John Deere	NU-1036, NU-1046	16"	A15596	AA14885	
John Deere	NU-1048	18"	A17431	AA15673	
John Deere	NU-1048. Left.	18"	A17432	AA15674L	
John Deere	NU-450 (metric)	18", 20"	32209	A32209M	
John Deere	Switch Plow	24"	P57264	A57264	
Massey	"N", "N" Heavy Duty	16", 18"	660204M1, 660206M	660204	
Melroe/Morris	General Purpose. Oliver Bottom	16", 18"	6522185-HB	M57-0353	
Melroe/Morris	General Purpose. Left	16"	35A1221	L61916	
Minneapolis	Nife line	16", 18"	20P42	M57-0353	
Oliver/White	419-619 Series	16"	R419-16	M57-0353	
Oliver/White	619 Series. Left	16"	HR21800B	L61916	
Oliver/White	619 Series	18"	R619-18	M57-0360	
Oliver/White	625 Series	18"	217531BS	R62518	
Wilrich	General Purpose	16", 18"	6522185-HB, 215177, A4258	M57-0353	

PLOW SHINS - Bolts not included. See listing below for bolt ordering information.

Note:

All Shins are right hand unless otherwise noted in the "Size" column. Hardware not included. Shins require (2) Grade 5, #3 Plow Bolts 7/16" x 1-1/4" or 1-1/2" long.

- Heat-Treated
- Sold Individually
- Painted Black Finish
- 1080 High Carbon Steel
- Hardware Not Included
- Solid Construction, 5/16" thick



Manufacturer	Models	Size	Bolt	Order No	Price	Manufacturer's No.	Order No.	Price
Allis Chalmers	387 Series	14, 16, 18"	3/8"	A 527846		347649	S30-0516	
Baker	Switch Plow	18"	7/16"	A 484089		SB101	ASB101	
Case	EXB16, EXC16	16"	3/8"	A 527846		T60002, T60003	E16S	
DMI	Hydrawide - All	16", 18"	7/16"	A 484089		33111602	EP7490	
Ford	General Purpose. Left.	12", 14", 16"				201345, 100368, 251436	105070	
Harrel	Switch Plow, Lower	18"				7920736	86CC	
Harrel	Switch Plow, Upper	18"				9820736	A9820736	
International	Super Chief. High Speed.	14, 16, 18"	7/16"	A 484089		488266R, 522325R	522325	
International	Super Chief. High Speed. Left	14, 16, 18"	7/16"	A 484089		55075C	464595	
John Deere	HS314, HS324, HS354, HS434, HS444, HS534, HS544	14"	7/16"	A 484089		A14700	8195A	
John Deere	HS316, HS326, HS356, HS436, HS446, HS536, HS546, SD546	16"	7/16"	A 484089		A14702	8196AA	
John Deere	NU-1036, NU-1046, NU-1048	16", 18"	7/16"	A 484089		A15594	A14883	
John Deere	NU-1036, NU-1046, NU-1048. Left	16", 18"	7/16"	A 484089		A15606, A51082	A14887	
John Deere	NU-400, NU-450 (metric)	All	7/16"	A 484089		A30129	A51080	
John Deere	Switch Plow. Right	24"	7/16"			P57266	A57266	
John Deere	Switch Plow. Left	24"	7/16"			P57265	A57265	
Massey Ferguson	"N", "N" Heavy Duty	12, 14, 16, 18"	7/16"	A 484089		660008M91, 660020M1	660020	
Massey Ferguson	"N", "N" Heavy Duty. Left	12, 14, 16, 18"	7/16"	A 484089		661584	661584	
Melroe/Morris/Wilrich	General Purpose	16", 18"	7/16"	A 484089		6522182, 213032, A4257	EP7490	
Melroe/Morris/Wilrich	General Purpose. Left	14", 16", 18"	7/16"	A 484089		6522182, 213032, A4257	217404L	
Minneapolis Moline	Nife Line	14", 16"	7/16"	A 484089		7490	EP7490	
National/David Brown	General Purpose	12", 14", 16"	7/16"	A 484089		7490, HS105	EP7490	
Oliver, Minneapolis	225, 425, 625, Nife line	12, 14, 16, 18"	7/16"	A 484089		EP7488C	EP7488	
Oliver	219, 419, 519, 619, 719	12, 14, 16, 18"	7/16"	A 484089		EP7490C	EP7490	
Oliver	219, 419, 519, 619, 719. Left	12, 14, 16, 18"	7/16"	A 484089		217404BS	217404L	
Oliver	549, 588, 598, 619 (deep till bottom)	18, 20"	7/16"	A 484089		230381B	220381B	

TILLAGE

LANDSIDES AND WEAR PADS



- 1/2" Thick
- Heat-Treated
- Sold Individually
- Painted Black Finish
- 1080 High Carbon Steel

Manufacturer	Model	Position	Type	Manufacturer's No.	Order No.	Price
Allis Chalmers	386, 387, 370, 392	Offset	LS	349819	A 489107	
Allis Chalmers	386, 387, 370, 392	-	WP	for 489107	A 489108	
Baker	Switch Plow		LS	5B-102	ASB102	
Baker	Short Switch Plow		LS	5B-103	ASB103	
Ford	General Purpose (after 1958)	Front	LS	107980	107980	
Ford	General Purpose (after 1958)	Rear	LS	107981	107981	
Harrel	Switch Plow. Front. 2-Hole	Small (4" x 6")	LS	79-010-36	A7920436	
Harrel	Switch Plow. Rear. 4-Hole	Med (4" x 12")	LS	79-205-36	A7920536	
International	Super Chief. 12-5/8" x 4-1/2" x 1/2"	Inner	-	59057, 1980672C2	L01-0100	
International	Super Chief. 6" x 4-1/2" x 1/2"	Outer	WP	59058C2	L01-0102	
International	Super Chief. 6" x 4-1/2" x 1/2"	RH & LH. Outer	WP	59058C1L	L01-0103	
International	Super Chief & Terra Flo	Front		522342R	522342	
International	Super Chief & Terra Flo	Front. LH		522342L	522342L	
International	Super Chief & Terra Flo	Rear. LH		522343L	522343L	
John Deere	HS300, 400, 500, SDT, NU	Right	WP	AA15262, A16495 for 918011	AA15262	
John Deere	HS300, 400, 500, SDT, NU	Left	WP	AA15263, A16496 for 1229565	AA15263L	
John Deere	NU-400, NU-450 (metric)	-	WP	A27862, A45226	A27862	
John Deere	Switch Plow. 2-Hole	RH & LH Short	WP	A27862, A45226	A27862	
John Deere	Switch Plow. Front. 2-Hole	Front 1/2" x 4" x 6-1/2"	WP	P57046	A57046	
John Deere			LS		A57052	
John Deere	Switch Plow. Rear. 4-Hole.	.5" x 8" x 11.5"	LS	P57522	A57522	
John Deere	Switch Plow. Rear. 3-Hole. 995 & 975	Rear. Large	LS	P60071	A60071	
Massey Ferguson	"N" Heavy Duty, High Speed	Front	Inner	475153M1	495937	
Melroe	General Purpose	Medium. 15"	LS	6526000	L01-0151	
Melroe	6252600	Reversible	WP	6526852	L01-0152	
Oliver	419, 425, 619, 619 slat, 625	Old offset	LS	218270B	L01-0180	
Wilrich	General Purpose. Solid Inner Plate	15-7/16"x4-1/2"x9/16"	LS	215111, A4253	L01-0250	
Wilrich	General Purpose. 2-Hole	4-1/2" x 5-7/8"	WP	215225, A4256	L01-0251	

Bolts not included. Plow shares are guaranteed against breakage for 1/2" of wear through the width of the plow share. Bolts are listed on page 139.

Made In The USA

Got the Adams Edge.



- 3/8" Thick
- Heat-Treated
- Painted Black Finish
- 1080 High Carbon Steel
- Hardware Not Included
- Sold In Cartons of 6 Only, except Baker

TILLAGE

Manufacturer	Model	Size	Bolt Size	Mfg. No.	Order No.	Price
Allis Chalmers	387 Series 4-hole	14, 16"	(1)1/2", (3)7/16"	347749, 347750, 347751, 572181, 572183, 572184	AM164RS AM164RSH*	
Allis Chalmers	387 Series 4-hole	18"	(1)1/2", (3)7/16"	573307, 347752	AM184RS AM184RSH*	
Baker	Switch Plow	18"	(6) 1/2"	SB100	BA256RS	
Baker	Switch Plow. Hardfaced Front Side	18"	(6) 1/2"	SB100	BA256RSHFS	
Case	EXA, B, C, D, E 3 & 4-hole	16"	(1)1/2", (3)3/8"	EE16A, T39128 CA163RSH*	CA163RS	
Case	EXA, B, C, D, E 3 & 4-hole. Left Hand	14"	(1)1/2", (3)3/8"	T39134, T39135, T39136	CA164LRS	
Case	EXA, B, C, D, E 3 & 4-hole	14"	(1)1/2", (3)3/8"	T39134, T39135, T39136	CA164RS	
Case	EXA, B, C, D, E 3 & 4-hole	16"	(1)1/2", (3)3/8"	T39134, T39135, T39136	CA164RSH*	
Case	EXA, B, C, D, E 4-hole	16"	7/16"	T63194, T63195, RCase6R	OM164RS	
Case	EXA, B, C, D, E 5-hole	18"	7/16"	RCase8R, T89974, T63097, T63133, T63206-RA18R	OM185RS	
Ford	General Purpose 3-hole	12"	7/16"	105203A	FF123RS	
Ford	General Purpose 3-hole short	14"	7/16"	7100369, 201573, 201579, 201585, 201586	FF143RS	
Ford	Heavy Duty 3 & 4-hole	14"	7/16"	7100369, 201573, 201579, 201585, 201586	FF144RS	
Ford	Heavy Duty 3-hole	16"	(3)7/16"	105207, 104413	FF163RS	
Ford	Heavy Duty 3 & 4-hole. Left Hand	16"	(4)7/16"	201581, 251426, 7100370	FF164LRS	
Ford	Heavy Duty 3 & 4-hole	16"	7/16"	7100370, 201575, 201581, 201587, 201588	FF164RS	
Ford	Heavy Duty 3 & 4-hole	16"	7/16"	201581, 251426, 7100370	FF164RSH*	
Ford	Heavy Duty 5 hole	18"	7/16"	7101980, 201589, 201596	FF185RS	
Ford	Heavy Duty 5 hole. Left Hand	18"	7/16"	7101980, 201589, 201596	FF185LRS	
Ford	150, 151, 152, 154 4-hole	16"	7/16"	SBP219627BF, 215427DS	OM164RS	
Ford	150, 151, 152, 154 4-hole short	16"	7/16"	SBP219627BF, 215427DS	OM164RS	
Ford	150, 151, 152, 154 5-hole	18"	7/16"	SBP219629BF, 251565DS	OM185RS	
Harrell	Switch Plow	18"	(5)7/16"	7900636	HA245RS	
Harrell	Switch Plow. Hardfaced Back Side	18"	(5)7/16"	7900636	HA245RSHBS	
Harrell	Switch Plow. Hardfaced Front Side	18"	(5)7/16"	7900636	HA245RSHFS	
International	Super Chief 3-hole	14"	7/16"	463228R, 463244R, 523835R51, 463248R1, 524173R31, 526773R3, 463228R1, 463244R1	MI143RS	
International	Super Chief 4-hole	14"	(1)1/2", (3)7/16"	463240R, 463236R, 462222R11, 4632401, 462226R11, 463252R1, 463232R2, 470955R1, 463236R1, 481959R1	IH144RS IH144RSH*	

*Hardfaced

Bolts not included. Plow shares are guaranteed against breakage for 1/2" of wear through the width of the plow share. Bolts are listed on page 139.

Made In The USA

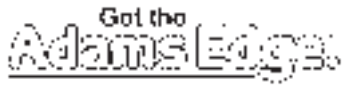

- 3/8" Thick
- Heat-Treated
- Painted Black Finish
- 1080 High Carbon Steel
- Hardware Not Included
- Sold In Cartons of 6 Only, except Baker

Manufacturer	Model	Size	Bolt Size	Mfg. No.	Order No.	Price
International	Super Chief 3-hole short	14"	(1)1/2", (2)7/16"	463228R, 463244R, 523835R51, 463248R1, 524173R31, 526773R3, 463228R1, 463244R1	MI143RS	
International	Super Chief 4-hole short	14"	(1)1/2", (3)7/16"	463240R, 463236R, 462222R11, 4632401, 462226R11, 463252R1, 463232R2, 470955R1, 463236R1, 481959R1	IH144RS IH144RSH*	
International	Super Chief 4 hole short. Left hand	16"	(1)1/2", (3)7/16"	143241R1, 462223R11, 462227R11, 463241R1, 463233R1, 463253R1, 463237R1, 470957R1	IH164LRSH*	
International	Super Chief 4 hole short	16"	(1)1/2", (3)7/16"	143241R1, 462223R11, 462227R11, 463241R1, 463233R1, 463253R1, 463237R1, 470957R1	IH164RS IH164RSH*	
International	Super Chief 3-hole	16"	7/16"	463245R, 463229R, 523836R51, 524174R31, 463246R1, 526774R3	MI163RS	
International	Super Chief 4-hole	16"	(1)1/2", (3)7/16"	462223R11, 462227R11, 463241R1, 463233R1, 463253R1, 463237R1, 470957R1	IH164RS IH164RSH*	
International	Super Chief 4-hole. Left Hand.	18", 20"	(1)1/2", (3)7/16"	463254R, 463238R, 481960R1, 481964R1, 492081R1, 481961R1, 481965R1	IH184LRS IH184LRSH* IH184LRSH76	
International	Super Chief 4-hole	18", 20"	(1)1/2", (3)7/16"	463254R, 463238R, 481960R1, 481964R1, 492081R1, 481961R1, 481965R1	IH184RS IH184RSH*	
John Deere	HS350, 400, 500 3-hole	14"	7/16"	A10005A, BC452, BC454, A10001A, A10101A, A10002A, A10102A, A10105A, A10006A, A10106A, CY102A	JD143RS	
John Deere	HS350, 400, 500, NU 4-hole	14"	(1)1/2", (3)7/16"	A10225, A10222, A10226, A14221, A14222, A14225, A14226, A14321, A14322, A14025, A10325, A10326, A51498, A10221	JD144RS	
John Deere	HS350, 400, 500, NU 4-hole short	14"	(1)1/2", (3)7/16"	A10225, A10222, A10226, A14221, A14222, A14225, A14226, A14321, A14322, A14025, A10325, A10326, A51498, A10221	JD144RS	
John Deere	HS350, 400, 500 3 hole	16"	7/16"	BC472, A10004, A10008, A10108, A20894, A32218, A32221, A32222, A40407, A40407, A42806, A10103, A10007, A10003	JD163RS	
John Deere	HS356, 400, 500, SDT, NU 4-hole. Left Hand.	16"	(1)1/2", (3)7/16"	A10227, A10224, A10228, A10327, A10323, A10324, A10328, A14027, A51500, A10223	JD164LRS JD164LRSH*	
John Deere	HS356, 400, 500, SDT, NU 4-hole	16"	(1)1/2", (3)7/16"	A10227, A10224, A10228, A10327, A10323, A10324, A10328, A14027, A51500, A10223	JD164RS JD164RSH*	
John Deere	HS356, 400, 500, SDT, NU 4-hole short	16"	(1)1/2", (3)7/16"	A10227, A10224, A10228, A10327, A10323, A10324, A10328, A14027, A51500, A10223	JD164RS JD164RSH*	
John Deere	NU-1048 5-hole. Left Hand.	18, 20"		A14243, A14244, A14344, A51504, A14343, A14044	JD185LRS JD185LRSH*	
John Deere	NU-1048 5-hole	18, 20"		A14243, A14244, A14344, A51504, A14343, A14044	JD185RS JD185RSH*	
John Deere	NU 450 (metric) 3-hole	18"	7/16"	A42808, A30951, A42807, A32222, A40408, A32221, A42806, A40407, A32217	JD183RS JD183RSH*	
John Deere	Switch Plow	18"	(4)7/16"	P57042, P57270, P59129	JD244RS	
John Deere	Switch Plow. Hardfaced Back Side	18"	(4)7/16"	P59130	JD244RSHBS	
John Deere	Switch Plow. Hardfaced Front Side	18"	(4)7/16"	P59130	JD244RSHFS	
Long	Switch Plow	18"	(5)7/16"	792800	LO245RS	
Long	Switch Plow. Hardfaced Back Side	18"	(5)7/16"	792800	LO245RSHBS	
Massey	"N" Heavy Duty 3-hole	14"	7/16"	660005, 463244M1	MI143RS	
Massey	"N" Heavy Duty 3-hole	16"	7/16"	463245M1	MI163RS	
Massey	"N" Heavy Duty 4-hole	16"	1/2"	475716M1, 475161M1	MF164RS MF164RSH*	
Massey	"N" Heavy Duty 4-hole. Left Hand.	16"	1/2"	475716M1, 475161M1	MF164LRS	
Massey	"N" Heavy Duty 4-hole. Left Hand.	18"	1/2"	475823M1	MF184LRS MF184LRSH*	
Massey	"N" Heavy Duty 4-hole.	18"	1/2"	475823M1	MF184RS MF184RSH*	
Melroe/Morris	387 Series. Drop Front Hole. 4-hole.	16"	(1) 1/2", (3)7/16"	347749, 572184	AM164RS AM164RSH*	
Melroe/Morris	387 Series. Inline Hole. 4-hole.	16"	(1) 1/2", (3)7/16"	6527052	MR164RS	
Melroe/Morris	387 Series. Drop Front Hole. 4-hole.	18"	(1) 1/2", (3)7/16"	573307	AM184RS AM184RSH*	
Melroe/Morris	387 Series. Inline Hole. 4-hole.	18"	(1) 1/2", (3)7/16"	6527054	MR184RS	
Melroe/Morris	Star GP. 4-hole.	14"	(1) 1/2", (3)7/16"	6526827	MM144RS	
Melroe/Morris	Star GP. 4-hole.	16"	(1) 1/2", (3)7/16"	6526832	MM164RS	
Melroe/Morris	Star GP. 4-hole.	18"	(1) 1/2", (3)7/16"	6526829	MM184RS MM184RSH*	
Oliver/White Case	619, 625, 719, 819, 434 3 & 4-hole. Left Hand.	16"	(1) 1/2", (3)7/16"	RCA6R, 219617BS	OC164LRS OC164LRSH*	

*Hardfaced **Special Order

Bolts not included. Plow shares are guaranteed against breakage for 1/2" of wear through the width of the plow share. Bolts are listed on page 139.

Made In The USA

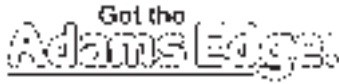

- 3/8" Thick
- Heat-Treated
- Painted Black Finish
- 1080 High Carbon Steel
- Hardware Not Included
- Sold In Cartons of 6 Only, except Baker

Manufacturer	Model	Size	Bolt Size	Mfg. No.	Order No.	Price
Oliver/White Case	619, 625, 719, 819, 434 3 & 4-hole.	16"	(1) 1/2", (3) 7/16"	RCA6R, 219617BS	OC164RS OC164RSH*	
Oliver/White Case	619, 625, 719, 819, 434 3 & 4-hole. Left Hand.	18"	(1) 1/2", (4) 7/16"	RCA8R, 219619BS	OC185LRS OC185LRSH*	
Oliver/White Case	619, 625, 719, 819, 434 3 & 4-hole.	18"	(1) 1/2", (4) 7/16"	RCA8R, 219619BS	OC185RS OC185RSH*	
Oliver/White Case	619, 625, 719, 819, 434 3 & 4-hole.	20"	(1) 1/2", (4) 7/16"	RCA20R, 220370BS	OC205RS OC205RSH*	
Oliver/White Case	619, 625, 719, 819, 434 3 & 4-hole. Left Hand.	12"	(3) 7/16"		OM123LRS**	
Oliver/White Case	619, 625, 719, 819, 434 3 & 4-hole, Nife line	14"	7/16"	RB14R, 219615BS, HD14FCO, RCase4S, 220013BS, RCase4R,	OM144RS OM144RSH*	
Oliver/White Case	619, 625, 719, 819, 434 3 & 4-hole short	14"	7/16"	RB14R, 219615BS, HD14FCO, RCase4S, 220013BS, RCase4R Left Hand	OM144RS OM144RSH* OM144LRS	
Oliver/White Case	619, 719, 819, 919, 625, 434 3 & 4-hole. Left Hand.	16"	7/16"	RB16R, HD16FCO, 219617BS, RCase6S, 220016BS, RCase6R	OM164LRS OM164LRSH*	
Oliver/White Case	619, 719, 819, 919, 625, 434 3 & 4-hole, Nife line	16"	7/16"	RB16R, HD16FCO, 219617BS, RCase6S, 220016BS, RCase6R	OM164RS OM164RSH*	
Oliver/White Case	619, 719, 819, 919, 625, 434 3 & 4-hole short	16"	7/16"	RB16R, HD16FCO, 219617BS, RCase6S, 220016BS, RCase6R	OM164RS OM164RSH*	
Oliver/White Case	619, 719, 819, 919, 625, 434 5-hole	16, 18, 20"	7/16"	RA18R, 219619BS, HD18FCO, RCase8R, 220024BS, RCase8S Left Hand.	OM185RS OM185RSH* OM185LRS	
Watts	All. 4-Hole. Left Hand.	All	7/16"	FO25	WA184LRS WA184LRSH*	
Watts	All. 4-Hole.	All	7/16"	FO25	WA184RS WA184RSH*	
Wilrich	GP. 4-Hole	18	1/2"	14255, 215806, 16047	WR184RSH	

SHARES - UPSET FORGED

Right handed, unless noted.



- 3/8" Thick
- Heat-Treated
- Painted Black Finish
- Sold In Cartons of 6 Only
- Long Wearing, High Carbon Steel

Manufacturer	Model	Size	Bolt Size	Mfg. No.	Order No.	Price
Allis Chalmers	387 Series. 4-Hole	16"	(1) 1/2" x 1-1/2", (3) 7/16" x 1-3/16"	347750	S26-0509	
Allis Chalmers	387 Series. 4-Hole	18"	(1) 1/2" x 1-1/2", (3) 7/16" x 1-3/16"	573307	S26-0510	
Case	EX A, B, C, D, E. 4-Hole	14"	(1) 1/2" x 1-1/4", (3) 7/16" x 1-3/16"	T39134	S26-0517	
Case	EX A, B, C, D, E. 4-Hole	16"	(1) 1/2" x 1-1/4", (3) 7/16" x 1-3/16"	T39135	S26-0518	
Ford	Heavy Duty. 4-Hole	14"	(1) 7/16" x 1-1/2", (3) 7/16" x 1-3/16"	7100369	S26-0520	
Ford	Heavy Duty. 4-Hole	16"	(1) 7/16" x 1-1/2", (3) 7/16" x 1-3/16"	7100370	S26-0521	
International	Super Chief. 4-Hole	14"	(1) 1/2" x 1-3/8", (3) 7/16" x 1-1/4"	463236R1, 463240R1, 463239R1	S26-0140	
International	Super Chief. 4-Hole	16"	(1) 1/2" x 1-3/8", (3) 7/16" x 1-1/4"	463237R1, 463241R1, 464343R1	S26-0141	
International	Super Chief. 4-Hole	18"	(1) 1/2" x 1-3/8", (3) 7/16" x 1-1/4"	463238R1	S26-0142	
John Deere	HS350, 400, 500, NU. 4-Hole	14"	(1) 1/2" x 1-3/8", (3) 7/16" x 1-3/4"	A10225, A10221, A10222, A10226	S26-0056	
John Deere	HS350, 400, 500, SDT, NU. 4-Hole	16"	(1) 1/2" x 1-1/4", (3) 7/16" x 1-3/16"	A10227, A10223, A10224, A10228	S26-0058	
John Deere	NU Bottoms. 4-Hole	18"	(1) 1/2" x 1-1/4", (3) 7/16" x 1-3/16"	A14243, A14224	S26-0060	
John Deere	NU 450 Metric. 3-Hole	18"	(3) M16 x M35	A42808, A30951	S26-0452	
Massey Ferguson	N Heavy Duty. 4-Hole	16"	(4) 1/2" x 1-3/8"	475715M1, 475716M1	S26-0522	
Melroe	General Purpose 992. 4-Hole	16"	(4) 7/16" x 1-1/4"	6526832	S26-0204	
Melroe	General Purpose 992. 4-Hole	18"	(4) 7/16" x 1-1/4"	6526829	S26-0203	
Oliver/White	619, 625, 718, 819 & 434. 4-Hole	14" Hvy Curved	(1) 1/2" x 1-3/8", (3) 7/16" x 1-1/4"	219615BS, RCA4R, RCA4S	S26-0251	
Oliver/White	619, 625, 718, 819 & 434. 4-Hole	16" Hvy Curved	(1) 1/2" x 1-3/8", (3) 7/16" x 1-1/4"	219615BS, RCA4R, RCA4S	S26-0302	
Oliver/White	619, 625, 718, 819 & 434. 5-Hole	18" Hvy Curved	(1) 1/2" x 1-3/8", (4) 7/16" x 1-1/4"	219615BS, RCA4R, RCA4S	S26-0253	
Oliver/White	619, 625, 718, 819 & 434. 5-Hole	18" LH Hvy Curved	(1) 1/2" x 1-3/8", (4) 7/16" x 1-1/4"	219615BS, RCA4R, RCA4S	S26-0254	
Wilrich	General Purpose. 4-Hole	18"	(4) 1/2" x 1-3/8"	215806, A4255	S26-0350	

TILLAGE

COULTERS - WAVY

Replaces Number	Application	Diam.	No. Waves	Wave Width	Gauge	Center Hole	Bolt Hole	Bolt Circle	Order Number	Price
A72678	JD Max Emerge 2, Plus, Pro, XP, XP Pro, ME5, Exact Emerge JD Max Emerge	16"	12	3/4"	.185"	2.125"	5) .510"	4.75"	B45-1122	
		16"	12	3/4"	.185"	2.015" Slotted	6) 4.06" x .469" & 3.375"	3.5"	B45-1123	
D7803-12	Kinze	15-13/16"	12	3/4"	.177"	3.984"	4) .531"	5.25"	B45-1124	
A73911	JD Max Emerge	16"	8					3.5"	B45-1125	
	JD Max Emerge	16"	24					3.5"	B45-1126	
820-082C	Great Plains, White, Yetter	17"	12	3/4"	.157"	3.97"	4) .531"	5.25"	B45-1120	
A73615	JD Max Emerge 2, Plus, Pro XP, XP Pro, ME5, Exact Emerge	16"	8					4.75"	B45-1127	
AC555152	AC	17-9/16"	8	1-3/4"	.175"	1.81"	6) .406"	3.25"	B45-1167	
55-318	Tye, DMI, Melroe, United Farm Tool Wilrich	17-5/8"	12	3/4"	.168"	3.640"	4) .531"	5.0"	B45-1121	
AL573885	AC	17-7/8"	8	1"	.170"	1.81"	6) .406"	3.25"	B45-1165	



COULTERS - FLUTED / RIPPLED

Replaces Number	Application	Diam.	Gauge	Center Hole	Bolt Hole	Bolt Circle	Order Number	Price
820-018C	Great Plains Yetter	17"	.138"	3.97"	4) .531"	5.25"	B45-1135	
FL179IH	IH	17"	.157"	.968"x1.344" Slot	6) .344"	3.25"	B45-1180	
FL207IH	IH	20"	.177"	.968"x1.344" Slot	6) .344"	3.25"	B45-1182	
FL207OL	White	20"	.177"	4.0"	4) .531"	5.25"	B45-1183	
N/A	DMI/Blue Jet	20"	7 GA	3-11/16"	8) .531"	5 & 5-1/4"	B45-1140	
	JD, Pioneer	17"	.157"	4"	4) .5"	4"	B45-1704	
	White Horse	17"	.187"	2"	6) 7/16"	3.5"	B45-1735	



COULTERS - PLAIN / FLAT

Replaces Number	Application	Diam.	Thickness	Center Hole	Bolt Hole	Bolt Circle	Order Number	Price
N214190	JD 750, 1850, 1560, 1690, 1860	18"	.203"	3.031"	4) .406"	4.375"	B45-3049	
N283804	No Till Grain Drills 1890, 1895, 1990							
19-4500-1-2	Buffalo	18"	.157"	2.25"	6) .390"	3.75"	B45-1185	
F205112S	Brilliant & Others	20"	5 GA	1.56" Sq.	N/A	N/A	B45-1150	
F205112R	Glencoe & Others	20"	5 GA	1.56" Rd.	N/A	N/A	B45-1160	
F225112R	Glencoe & Others	22"	5 GA	1.56" Rd.	N/A	N/A	B45-1162	
	AC, Krause Chisel Plows	20.5"	3/16"	1.5" Rd.	N/A	N/A	2036	
	Wilcox & Others	24"	3/16"	4.125	5-1/2"	5.25"	2436A	



COULTERS - BUBBLE

Replaces Number	Application	Diam.	Gauge	Center Hole	Bolt Hole	Bolt Circle	Order Number	Price
AC595266	AC	16-13/16"	.160"	1.81"	6) .460"	3.25"	B45-1170	
A22336, A24947, A73910	JD, 16", A24997 Kinze, 16", 24-3112	17"	.160"	2.00"	6) .406" x .469"	3.375" & 3.50"	B45-1173	



COULTER - CONCAVE

Fits Buffalo. Replaces 3-4400-17.
Diameter: 14"
Gauge: .157"
Center Hole: 2.81"
Bolt Holes: 4
Bolt Hole Size: .406"
Bolt Circle: 4"



Order No. Price
B45-1186

HARRELL CROP CHOPPERS

- OEM Quality
- 3/8" Heat Treated High Carbon Steel
- (4) .7" x 1.65" Bolt Holes

Size	Replaces	Order No	Price
24"	HA9301175	B45-2324	
36"	HA9300575	B45-2336	
38"	HA9300775	B45-2338	



COTTON STALK PULLER/CHOPPER BLADES

Replacement Blade Only with 12 Welded Cleats, 1/4" x 3" x 3". Fits Besler & Sundance. Replaces PP28 and SC7. 27-3/8" diameter. 1/4" Thick.

Center Hole	Bolt Hole	Bolt Circle	Order Number	Price
4.688"	.515" (6)	6"	B45-2300	



Fits Amadas Cotton Stalk Choppers. 20" Long 8" wide at point 5" wide at ends 3/8" thick with (3) 1/2" slotted mounting holes. Replaces 61517.

Order Number Price
B45-2320



DEEP TILLAGE DISC RIPPER BLADES

Fits CIH, DMI Ecolo, Turbo Tiger, Turbo Tiger II, 527, 527B, 530, 530B, 730, 730B, 9300, ST650, ST720, ST770

Description	Diameter	Gauge	Center Hole	Bolt Hole	Bolt Circle	Order Number	Price
20" Curved Smooth Coulters Blade	20"	.25"	4"	(5) 1/2"	5.5"	B45-2530	
22" Curved Smooth Coulters Blade	22"	.25"	4"	(5) 1/2"	5.5"	B45-2730	



Herschel disc blades are made of cross rolled steel which provides more even wear across the edge and less breakage. Other manufactures use single rolled steel.

STANDARD CONCAVITY, SOLID EDGE



Gauge To Inch Conversion:

12 Gauge	=	.104" (2.6 mm)
11 Gauge	=	.119" (3 mm)
10 Gauge	=	.134" (3.4 mm)
9 Gauge	=	.149" (3.8 mm)
8 Gauge	=	.164" (4.2 mm)
7 Gauge	=	.179" (4.5 mm)
6 Gauge	=	.194" (5 mm)
5 Gauge	=	.209" (5.3 mm)
4 Gauge	=	.224" (5.7 mm)
3 Gauge	=	.236" (6 mm)

- Popular Sizes & Gauges Available
- High Carbon Steel, Accurately Hardened.
- Dual Punch Centers for Inventory Reduction.
- Precision Double Bevel for Superior Penetration.
- Backed by Herschel Warranty for Quality and Workmanship.

Diam.	Gauge	Hole Size	Concavity	Order No	Price
16"	11 GA	7/8" Sq. x 1" Sq.	1-1/2"	B45-2001	
16"	11 GA	7/8" Sq. x 1" Rd.	1-1/2"	B45-2007	
16"	11 GA	1" Sq. x 1-1/8" Sq.	1-1/2"	B45-2003	
16"	11 GA	1-1/8" Sq.	1-1/2"	B45-2009	
18"	9 GA	7/8" Sq. x 1" Rd.	1-3/4"	B45-2030	
18"	9 GA	1" Sq. x 1-1/8" Sq.	1-3/4"	B45-2024	
18"	9 GA	1-1/8" Sq.	1-3/4"	B45-2028	
18"	9 GA	1-1/8" Sq. x 1-1/4" Sq.	1-3/4"	B45-2025	
18"	9 GA	1-1/4" Sq. x 1-1/2" Rd.	1-3/4"	B45-2023	
18"	7 GA	1-1/8" Sq.	1-3/4"	B45-2181	
18"	7 GA	1-1/8" Sq. x 1-1/4" Sq.	1-3/4"	B45-2015	
18"	9 GA	7/8" Sq. X 1" Sq	1-3/4"	B45-2243	
20"	7 GA	1" Sq. x 1-1/8" Sq.	2-1/4"	B45-2040	
20"	7 GA	1-1/8" Sq.	2-1/4"	B45-2043	
20"	7 GA	1-1/8" Sq. x 1-1/4" Sq.	2-1/4"	B45-2042	
20"	7 GA	1-1/4" Sq. x 1-1/2" Rd.	2-1/4"	B45-2044	
20"	7 GA	1-1/2" Sq. x 1-3/4" Rd.	2-1/4"	B45-2045	
22"	7 GA	1-1/8" Sq. x 1-1/4" Sq.	2-1/2"	B45-2052	
22"	7 GA	1-1/4" Sq. x 1-1/2" Rd.	2-1/2"	B45-2048	
22"	7 GA	1-1/2" Sq. x 1-3/4" Rd.	2-1/2"	B45-2049	
22"	7 GA	2" Rd.	2-1/2"	B45-2238	
22"	6 GA	1-1/8" Sq. x 1-1/4" Sq.	2-1/2"	B45-2145	
22"	6 GA	1-1/8" Sq.	2-1/2"	B45-2149	
22"	1/4"	1-1/8" Sq. x 1-1/4" Sq.	2-1/2"	B45-2100	
22"	1/4"	1-1/4" Sq. x 1-1/2" Rd.	2-1/2"	B45-2107	
22"	1/4"	1-1/2" Sq. x 1-3/4" Rd.	2-1/2"	B45-2105	
22"	1/4"	1-1/8" Sq.	2-1/2"	B45-2111	
22"	1/4"	2" RD		B45-2087	
22"	7 GA	1-1/8" Sq.	2-1/2"	B45-2196	
22"	6 GA	1-1/2" Rd.	2-1/2"	B45-2242	
22"	1/4"	2-5/16" Rd.	2-1/2"	B45-2247	
24"	1/4"	1-1/8" Sq. x 1-1/4" Sq.	3-1/4"	B45-2070	
24"	1/4"	1-1/4" Sq. x 1-1/2" Rd.	3-1/4"	B45-2074	
24"	1/4"	1-1/2" Sq. x 1-3/4" Rd.	3-1/4"	B45-2075	
24"	1/4"	1-1/2" Sq.	3"	B45-2160	
24"	1/4"	1-1/8" Sq.	3-1/4"	B45-2113	
24"	6 GA	1-1/8" Sq.	3-1/4"	B45-2270	
26"	1/4"	1-1/2" Sq. x 1-3/4" Rd.	3-1/2"	B45-2120	
26"	1/4"	1-1/2" Rd.	3-1/2"	B45-2252	
26"	1/4"	2 RD	3-1/2"	B45-2091	

STANDARD CONCAVITY, NOTCHED EDGE



Gauge To Inch Conversion:

12 Gauge	=	.104" (2.6 mm)
11 Gauge	=	.119" (3 mm)
10 Gauge	=	.134" (3.4 mm)
9 Gauge	=	.149" (3.8 mm)
8 Gauge	=	.164" (4.2 mm)
7 Gauge	=	.179" (4.5 mm)
6 Gauge	=	.194" (5 mm)
5 Gauge	=	.209" (5.3 mm)
4 Gauge	=	.224" (5.7 mm)
3 Gauge	=	.236" (6 mm)

- Popular Sizes & Gauges Available
- High Carbon Steel, Accurately Hardened.
- Dual Punch Centers for Inventory Reduction.
- Precision Double Bevel for Superior Penetration.
- Backed by Herschel Warranty for Quality and Workmanship.

Diam.	Gauge	Hole Size	Concavity	Order No	Price
16"	11 GA	7/8" Sq. x 1" Sq.	1-1/2"	B45-2002	
16"	11 GA	1" Sq. x 1-1/8" Sq.	1-1/2"	B45-2004	
18"	7 GA	1-1/8" Sq. x 1-1/4" Sq.	1-3/4"	B45-2016	
18"	7 GA	1-1/8" Sq.	1-3/4"	B45-2233	
18"	9 GA	7/8" Sq. x 1" Sq.	1-3/4"	B45-2244	
18"	9 GA	7/8" Sq. x 1" Sq.	1-3/4"	B45-2244	
18"	9 GA	7/8" Sq. x 1" Rd.	1-3/4"	B45-2027	
18"	9 GA	1" Sq. x 1-1/8" Sq.	1-3/4"	B45-2021	
18"	9 GA	1-1/8" Sq. x 1-1/4" Sq.	1-3/4"	B45-2026	
18"	1/4"	1-1/2" Sq.	1-3/4"	B45-2018	
20"	7 GA	7/8" Sq. x 1" Rd.	2-1/4"	B45-2061	
20"	7 GA	1" Sq. x 1-1/8" Sq.	2-1/4"	B45-2041	
20"	7 GA	1-1/8" Sq.	2-1/4"	B45-2199	
20"	7 GA	1-1/8" Sq. x 1-1/4" Sq.	2-1/4"	B45-2046	
20"	7 GA	1-1/4" Sq. x 1-1/2" Rd.	2-1/4"	B45-2047	
20"	7 GA	1-1/8" Sq.	2-1/4"	B45-2199	
20"	1/4"	1-1/2" Sq.	1-3/4"	B45-2020	
22"	7 GA	1-1/8" Sq.	2-1/2"	B45-2203	
22"	7 GA	1-1/8" Sq. x 1-1/4" Sq.	2-1/2"	B45-2051	
22"	7 GA	1-1/4" Sq. x 1-1/2" Rd.	2-1/2"	B45-2055	
22"	7 GA	1-1/2" Sq. x 1-3/4" Rd.	2-1/2"	B45-2056	
22"	6 GA	1-1/8" Sq.	2-1/2"	B45-2147	
22"	6 GA	1-1/8" Sq. x 1-1/4" Sq.	2-1/2"	B45-2148	
22"	6 GA	1-1/2" Sq. x 1-3/4" Rd.	2-1/2"	B45-2146	
24"	1/4"	1-1/8" Sq. x 1-1/4" Sq.	3-1/4"	B45-2071	
24"	1/4"	1-1/4" Sq. x 1-1/2" Rd.	3-1/4"	B45-2076	
24"	1/4"	1-1/2" Sq. x 1-3/4" Rd.	3-1/4"	B45-2077	
26"	1/4"	1-1/2" Sq. x 1-3/4" Rd.	3-1/2"	B45-2122	
26"	5/16"	1-1/2" Sq. x 1-5/8" Rd.	3-1/2"	B45-2228	

Additional Sizes Available.
Call Customer Service To Order!

TILLAGE

CONE STYLE, SOLID EDGE - JD

3.87" Concavity



Diam.	Thickness	Hole Size	Order No.	Price
20"	7 GA	1-1/8" Sq. x 1-1/4" Sq.	B45-2097	
22"	7 GA	1-1/8" Sq. x 1-1/4" Sq.	B45-2098	
24"	1/4"	1-1/2" Sq.	B45-2072	
26"	1/4"	1-1/4" Sq. 4-3/4" Concavity	B45-2123	
26"	1/4"	1-1/2" Sq. 4-3/4" Concavity	B45-2119	

CONE STYLE, NOTCHED EDGE - JD

3.87" Concavity



Diam.	Thickness	Hole Size	Order No.	Price
22"	7 GA	1-1/8" Sq. x 1-1/4" Sq.	B45-2099	
24"	1/4"	1-1/2" Sq.	B45-2073	
26"	1/4"	1-1/4" Sq. 4-3/4" Concavity	B45-2124	
26"	1/4"	1-1/2" Sq. 4-3/4" Concavity	B45-2121	

FLAT CENTER STYLE, SOLID EDGE - IH

2" Concavity

B45-2092



Diam.	Thickness	Hole Size	Order No.	Price
20"	7 GA	1-1/8" Sq.	B45-2092	
22"	7 GA	1-1/8" Sq.	B45-2094	
22"	6 GA	1-1/8" Sq.	B45-2159	
22"	6 GA	1-1/2" Sq.	B45-2250	
22"	1/4"	1-1/2" Rd	B45-2266	

FLAT CENTER STYLE, NOTCHED EDGE - IH

2" Concavity

B45-2093



Diam.	Thickness	Hole Size	Order No.	Price
20"	7 GA	1-1/8" Sq.	B45-2093	
22"	7 GA	1-1/8" Sq.	B45-2095	
22"	6 GA	1-1/8" Sq.	B45-2158	
22"	6 GA	1-1/2" Rd.	B45-2251	
26"	1/4"	1-1/8" Sq.	B45-2258	

JOHN DEERE 1-1/8" SQUARE AXLES

See Page 148 For More Disc Parts



Description	OEM No.	Order No.	Price
1-1/8" SQ 50.7" DISC AXLE	A20133	HA20133	
1-1/8" SQ 59.7" DISC AXLE	A20134	HA10134	
1-1/8" SQ 68.7" DISC AXLE	A20615	HA20615	
1-1/8" SQ 77.7" DISC AXLE	A20616	HA20616	
1-1/8" SQ 87" DISC AXLE	A20617	HA50617	
1-1/8" SQ 95.7" DISC AXLE	HA40826	HA40826	
AXLE NUT 1-1/8"	220089	N83-0118	

SPECIAL CONCAVITY, SOLID EDGE

Miller and New Holland

B45-2069



Diam.	Thickness	Hole Size	Concavity	Order No.	Price
22"	7 GA	1-1/2" Sq. x 1-3/4" Rd.	3-1/4" Rear	B45-2069	
24"	1/4"	1-1/2" Sq. x 1-3/4" Rd.	2-5/8" Front	B45-2081	

SPECIAL CONCAVITY, NOTCHED EDGE

Miller and New Holland

B45-2082

2-5/8" Front Concavity



Diam.	Thickness	Size	Order No.	Price
24"	1/4"	1-1/2" Sq. x 1-3/4" Rd.	B45-2082	

DISC JOINER BLADE

Fits White Plows. Replaces 220384B.
.177" Thick, 20" Diameter



Center Hole	Bolt Hole	Bolt Circle	Order No	Price
3.15"	(4) .55"	5.23"	B45-2290	

TIONAL 1-1/8" SQUARE AXLES

Description	OEM No.	Order No.	Price
1-1/8" SQ 40.14" DISC AXLE	468607	HA468607	
1-1/8" SQ 49" DISC AXLE	471014R1	H47101HR1	
1-1/8" SQ 57.6" DISC AXLE	471015R1	H471015R1	
1-1/8" SQ 67.4" DISC AXLE	652939R2	H652939R2	
1-1/8" SQ 71.9" DISC AXLE	472586R2	H472586R2	
1-1/8" SQ 76.4" DISC AXLE	468582R2	H468582R2	
1-1/8" SQ 79.4" DISC AXLE	46883R2	H46883R2	
1-1/8" SQ 85.5" DISC AXLE	481844R1	H481844R1	
1-1/8" SQ 94.6" DISC AXLE	487168R1	H487168R1	
1-1/8" SQ 103.4" DISC AXLE	58829C1	H58829C1	
AXLE LOCK	P34101	HP34101	
AXLE NUT 1-1/8"	220089	N83-0118	

VERTICAL TILLAGE

SAMURAI EDGE - 24 WAVE

The Samurai Edge excels on high speed vertical tillage because it uniquely sizes the residue back into the soil. Its design also stays sharp longer and positively turns with the tractor which decreases fuel consumption.



Application	Concavity	Diameter	Thickness	# Of Bolt Holes	Hole Size	Bolt Holes	Bolt Hole Size	Circle	Order No.	Price
Great Plains, Yetter, Salford, White, DMI, etc.	1.75"	18"	5 mm	4"		4	.531"	5" & 5.25"	B45-4009	
CNH 330 Turbo & other CNH machines. Raised Flat Center	1.75"	20"	6 mm	1.25 S x 1.5 R					B45-4002	
John Deere, Krause, Landoll, Sunflower, etc.	1.75"	20"	5 mm	1.5 S x 1.75 R					B45-4011	
John Deere, Krause, Landoll, Sunflower, etc.	2"	22"	6 mm	1.5 S x 1.75 R					B45-4005	
Various Vertical Tillage Equipment	1.75"	20"	5 mm	1.125 S x 1.25 S					B45-4003	
Various Vertical Tillage Equipment	2"	22"	5 mm	1.125 S x 1.25 S					B45-4006	

VERTICAL TILLAGE BLADES - 24 WAVE

- Excellent Crop Residue/Soil Mixing
- Made of Boron Steel For Long Life



Application	Concavity	Diameter	Thickness	Hole Size	Bolt Order No.	Price
CNH 330 Turbo & other CNH machines. Raised Flat Center	1.75"	20"	6 mm	1.25 S x 1.5 R	B45-4001	
John Deere, Krause, Landoll, Sunflower, etc.	2"	22"	6 mm	1.5 S x 1.75 R	B45-4016	

RESIDUE RAZOR

- Razor Sharp Edge For Easy Penetration And Residue Sizing.
- Shallow Concavity To Increase Penetration & Minimal Soil Disturbance.
- Made of Boron Steel For Long Life

Fits Landoll and Great Plains. 22" Diameter. 5 mm thick.



Hole Size	Order No.	Price
1.5 S x 1.75 R	B45-4014	

VERTICAL TILLAGE BLADES

- Great Soil Mixing Action
- Made of Boron Steel For Long Life

Flat Blade. 20" Diameter. 5 mm thickness.

Fits Various Vertical Tillage Equipment

# Of Waves	Hole Size	Order No.	Price
8	1.5 S x 1.75 R	B45-4020	
8	1.5 R	B45-4021	
13	1.5 S x 1.75 R	B45-4022	
13	1.5 R	B45-4023	
13	1.125 S x 1.25 S	B45-4024	

Disc Bearing Identification Code

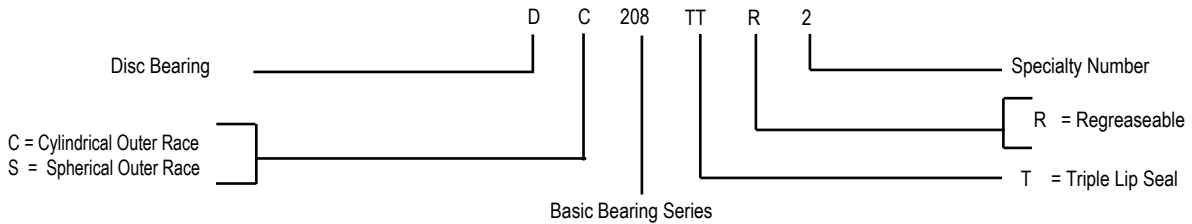

CYLINDRICAL OUTER RACE - DC SERIES

BCA Number	Bore Size (A)	Outer Diam. (B)	Outer Race Width (C)	Inner Race Width (D)	Order No	Price
DC208TT5	1-1/8", SQ	3.1496"	.709	1.438	B15-3180	
DC208TT8	1-1/8", SQ	3.1496"	1.185	1.438	B15-3190	
DC211TT3	1-1/2", SQ	3.397"	1.313	1.313	B15-3184	
DC211TTR3	1-1/2", SQ	3.397"	1.313	1.313	B15-3188	
DC211TT5	1-1/2", SQ	4.000"	1.438	1.750	B15-3182	
DC208TTR17	1-1/8" RD	3.376"	1.438	1.188	B15-3157	
DC211TTR2	2-3/16" RD	3.968"	1.313	1.313	B15-3158	
DC210TTR9	1-15/16" SQ	3.543"	1.438	0.906	B15-3159	
DC211TTR14	1-3/4" RD	3.937"	1.313	0.984	B15-3160	

SPHERICAL OUTER RACE - DS SERIES

BCA Number	Bore Size (A)	Outer Diam. (B)	Outer Race Width (C)	Inner Race Width (D)	Order No	Price
DS208TT6	1", SQ	3.158"	.709	1.438	B15-3176	
DS208TT5	1-1/8", SQ	3.1496"	.709	1.438	B15-3050	
DS208TT8	1-1/8", SQ	3.1496"	1.188	1.438	B15-3110	
DS208TTR8	1-1/8", SQ	3.150"	1.188	1.438	B15-3186	
DS208TT12	1-1/8", SQ	3.4340"	1.188	1.438	B15-3170	
DS210TTR4	1-1/8", SQ	3.5433"	1.188	1.188	B15-3144	
DS209TT5	1-1/4", SQ	3.347"	1.188	1.438	B15-3185	
DS209TTR5	1-1/4", SQ	3.3465"	1.188	1.438	B15-3125	
DS208TT7	1-3/16", RD	3.1496"	.709	1.188	B15-3080	
DS209TT4	1-1/2", RD	3.3465"	1.188	1.188	B15-3120	
DS209TTR4	1-1/2", RD	3.3465"	1.188	1.188	B15-3124	
DS211TTR3	1-1/2", SQ	3.397"	1.313	1.313	B15-3187	
DS211TT3	1-1/2", SQ	3.9370"	1.313	1.313	B15-3150	
DS211TT6	1-1/2", SQ	4.125"	1.438	1.750	B15-3181	
DS209TTR10	1-3/4", RD	3.3465"	.866	1.438	B15-3130	
DS209TT2	1-3/4", RD	3.347"	1.188	1.188	B15-3178	
DS210TT2	1-15/16", RD	3.543"	1.188	1.188	B15-3183	
DS210TTR2	1-15/16", RD	3.5433"	1.188	1.188	B15-3142	
DS211TTR2	2-3/16", RD	3.937"	1.313	1.313	B15-3177	
DS208TT11	7/8" SQ	3.438"	1.438	1.438	B15-3155	
DS208TTR5	1-1/8" SQ	3.150"	1.438	0.945	B15-3156	
DS208TT9	1" SQ	3.438"	1.438	1.438	B15-3161	
DS210TT5	1-3/4" RD	3.543"	1.188	1.188	B15-3162	
DS208TT2A	1-1/2" RD	3.150"	1.688	1.188	B15-3163	
DS211TT2	2-3/16" RD	3.937"	1.313	1.313	B15-3164	
DS208TTR10	1-1/4" SQ	3.347"	1.438	0.866	B15-3165	
DS208TTR2	1-3/4" RD	3.347"	1.188	1.188	B15-3166	

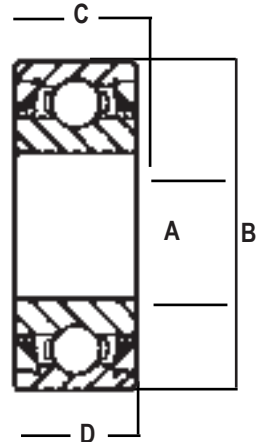

All Herschel heavy duty disc bearings feature long lasting triple lip seals.

RIVETED 4-BOLT FLANGE -- FD SERIES

BCA Number	Bore Size (A)	Order No	Price
FD209RA, ST491A	1-3/4", RD	B15-3010	
FD209RB	1-1/2", RD	B15-3179	

TILLAGE

Order Number	OEM Number	B.C.A. Part No.	Fafnir Number	Bore Size / Type	Mfr.	Application
B15-3180	7129	DC208TT5	W208PP5	1-1/8 SQ	Athens	Ridger
	GA15			Sealed	Bingham	Bedder
	7129				Blanton	Disc Harrow
	9554A				Burch	Ridger, 8 Row
	16-1-176, 795006			Bush Hog	Bedder & Ridger Charles Mach.	Trencher
	H747139				Case	Trencher
	JD9350				Deere	F871, F901, F984, F981, F982 Bedder
	X08738, X09838				Deutz-Allis Forest City Hester	Ridger Disc Harrow
	963889R91				IH/Case	
	06A51-001				Kelly	Coulter
	B8018				Kewanee Minn-Moline Multi-Purpose Piper Taylor	Hipper, Ridger Ridger Disc Harrow, Ridger
	7992				Towner	100, 101 Ridger
	552209				Tye	
481202				W & A Mfg.	Ridger & Does More	
B15-3190	BC1	DC208TT8	W208PP8	1-1/8" SQ	Blanton	
	9C16			Sealed	Brillion	
	AA14878				Deere	23, 2FK, F871, F901, F902, F984 Bedders
B15-3184	BC1				King Plow	
	11071	DC211TT3	W211PP3	1-1/2" SQ Sealed	Amco Athens	516, 517, F15 Disc Harrow Levee Plow, 1st Series
	H747444				Case Deutz-Allis Domries	Trencher K7 Disc 1-1/2" Axle Series
	MULCBB112				Ford	219, 223 Cutting Disc
	B2055				Kewanee	Disc Harrow
B15-3188	1905678M1				M. F.	Disc Harrow
	6510628				Melrow	
	G11071	DC211TTR3	GW211PP3	1-1/2" SQ	Amco Relube Athens	WOF3, WOF5, WOF6, WOJ3, WOJ4, Offset Disc Disc Harrow
	14-6-430				Bush Hog	145, 146, 246, 1435, 1437 w/1-1/2" gang bolt
	T51653				Case	E30, G109, G110, G119, K23, K23A Disc Harrow Disc Harrow
	G1046430				Greenline Kewanee	
	481213				W & A Mfg.	
B15-3182	85481014 406677	DC211TT5	W211PP5	1-1/2" SQ Sealed	Badger Deutz-Allis	3100, K, KT, WKT Disc
B15-3050	10272	DS208TT5	W208PPB5	1-1/8" SQ Sealed	Amco Athens	WTD5, WTD6, LFD2, LFD82 Disc Ridger
	2J516				Brillion	
	J9373				Burch Caldwell	Ridger, E-Z Set, E-2GO, Early 1-1/8 Axle Models
	T16288				Case Chatanooga	
	JD9248, A20175				Deere	8500, F810H, F850H
	GK260				Dunham	Disc Harrow
	261750				Eversman	
	1R41009				Farmhand	
	630210R91				IH/Case	Ridger
	06A51001				Kelly	
	B7980, G0052604				Kewanee Krause	206, 400 Disc
	843638M1, 190566M1				M. F.	
	NDAS4508BJ				N.H. (Ford)	
744-P				Pico	LO, 175, 185, 200, 206, 300, LT400, 720	
B15-3135	24A5301				Sunflower	
	T60	DC210TT2	W210PP2	1-15/16"RD Sealed	Tuffline	Disc Harrow, 1-1/8 Gang Bolt
B15-3176	11079	DS208TT6	W208PPB6	1" SQ Sealed	Amco White Domeries	LFBD2, LFB2, LTB2
	14-22-63				Amco Athens	
	T15820				Bush Hog	
	710152				Case	Small Ridger
	834367M1, 1025130M1				Hesston	Disc Harrow
	6519831				M. F.	21 Disc Harrow
	552207				Melroe Tye	

TILLAGE

Order Number	OEM Number	B.C.A. Part No.	Fafnir Number	Bore Size / Type	Mfr.	Application
B15-3080	430796	DS208TT7	W208PPB7	1-3/16" RD Sealed	Deutz-Allis	
	40-102,				Krause	Disc Harrow
	P-212-10-2				Long	
	9-90155				Oliver	241,352,250 Series Wheel Disc
	237092B,				Sunflower	
B15-3110	30-1005197, 1186	DS208TT8	W208PPB8	1-1/8" SQ Sealed	White	
	237092B				Amco	WTD10,WTD3,WTD4 Disc
	10333				Brillion	
	9C16				Case	
	T25486				Deere	
	JD9286, JD9300				Deutz-Allis	
	X10928				New Idea	
	213778B				Talbot	
	T151				Toner	101 Ridger
	7906				Amco	13-1/2 Pulverizing Disc
B15-3186	G10333	DS208TTR8	GW208PPB8	1-1/8" SQ Relube	Ford	241, 242, 243, 246, Disc Harrows
	SBP238481B				Kewanee	500, 600 Disc
	B2151				New Holland	
	SBP238481B				Oliver	263 Disc
	238481B				Taylor	200000, Series Disc
	207359				White	
	W238481B				Blanton	Square Axle Disc
	1023				Bush Hog	Disc Harrow
B15-3170	14-24-26	DS208TT12	W208PPB12	1-1/8" SQ Sealed	Case	Disc Harrow
	T28503				Case/IH	
	ST607, ST658				Dunham	Disc Harrow (Wide O.R.)
	266740				Eversman	
					Hardee	Disc Harrow
					IMCO	Wheel Disc
	BB-2N				King Plow	KGB, WGH, EZB, MFB
						Disc Harrow
	37-61-001				Lilliston	
	9-90092				Long	958, 959 Disc
	447899M1				M. F.	34MTD & 33 Rev. Disc
					McClesky	F228, L150 Harrow
					Rome	7-1/2 Disc Harrow
					Southern	Disc Harrow, 13' Pulv. Disc
	204147				Taylor	Disc Harrow Light Duty
		12-1/2, 19 & 21				
15013	Towner	101 Ridger 420, 425 Disc				
B15-3178	T602	DS209TT2	W209PPB2	1.7717" RD Sealed	Turflite	Disc Harrow 1-1/8
	14-4-5				Bush Hog	1432, 1436 Disc
	H747410				Case	Trencher
	430478				Deutz-Allis	Disc Harrow
	310072				Farmhand	Disc Harrow
	113903				Ford	204, 210, 224, 230 Disc
	1251062C91				IH/Case	Disc Harrow
	835050M1				M. F.	28, 33, 34, 68 Disc Harrow
	20H2152				Minn-Moline	Disc Harrow
					Shaffer	Disc Harrow
	7044				Unverferth	Disc Harrow
	B15-3120				340103	DS209TT4
40-104,						
P412-10-2		Krause	Disc Harrow			
B15-3124	34002	DS209TTR4	GW209PPB4	1.535 RD Relube	M. F.	
	AN240220				Wil Rich	
	21842400				Deere	
	EP6576				DMI	
	05A51001				Farmhand	
	40-105, 612-10-2				Kelly	
	1065010003				Krause	Disc Harrow
1829	Landoll					
B15-3185	JD8664	DS209TT5	W209PPB5	1-1/4" SQ Sealed	Sunflower	
	126-068				Deere	9000 Drill, 4400 Combine
	842303M1				FMC	Harvester
B15-3125	5449031	DS209TTR5	GW209PPB5	1-1/4" SQ Relube	M. F.	520, 620 Disc Harrow
	842342M1				Piper	Do-All
B15-3130		DS209TTR10	GW209PPB11	1-3/4" RD Relube	Caukins	
	A20649				Taylor	Disc Harrow
B15-3183		DS210TT2	W210PPB2	1-15/16" RD	Deere	210, 220, 230 Disc
	11052				Amco	Disc Harrow
					Burch	EZ, EZ-A, EZ-B, 145 Disc, 30565
					Sealed	Kwik Set Hipper/Ridger
	14-5-109				Bush Hog	145
	K85				Domries	
	10771				Farmhand	
	177849				Ford	
					G & M	3 PT Vinyard Disc
	831960M3				M. F.	Plow
3055,3056	Shaffer	Disc Harrow				
408808D		Strathmore				
		White				

Order Number	OEM Number	B.C.A. Part No.	Fafnir Number	Bore Size / Type	Mfr.	Application
B15-3142	G10771	DS210TTR2	GW210PPB2	1-15/16" RD	Amco	Disc Harrow
	T53781			Case	F21, F21H Disc Harrow	
	G10771			Farmhand	Disc Harrow	
B15-3144	B2246	DS210TTR4	GW210PPB4	1-1/8" SQ Relube	Kewanee	100, 1025, 1100, 1200 Disc
B15-3177	T57559	DS211TTR2	GW211PPB2	2-3/16" RD	Case	
B15-3150	24022	DS211TT3	W211PPB3	Relube	Wil Rich	Disc Harrow
	3J131			1-1/2" SQ	Brillion	
	203214			Sealed	Burch	Offset Disc
	7377-1				Farmhand	
	MULCB112SG				Ford	236 Cutting Disc
	630095R91, ST627A, 6395R					
	832540M1					
	4404-P					H/Case M. F. Pico
B15-3187	G10906	DS211TTR3	GW211PPB3	1-1/2" SQ Relube	Amco Athens	Disc Harrow Disc Harrow, New Ground Disc
	78672A			Burch	Offset Disc, Super Tandem	
	T51610			Case	K23, K23A, G59 Disc	
	70583939			Deutz-Allis	2600 Disc	
	9-92088			Long		
	449432M1			M. F.	30, 40, 520, 620, 720 Disc Harrow	
	207022			Taylor	Disc Harrow, Heavy Duty	
	237909B			White		
	B15-3181				DS211TT6	W211PPB6
204-82		Long	958, 959, 960, 1090 Disc Harrow			
9-90241		Taylor	Disc Harrow, Extra HD			
204679		Towner	510, 515, 577, 532, 534, 535, 560, 600, 620, 621, 630			
18300			315, 330, 350, 370, 470, 475, 480, 485, 490, 496, 610			
B15-3010	ST491A	FD209RA	DHU491A	1-3/4" RD Relube	IH/Case	
B15-3179	1A64318	FD209RB	DHU1-1/2 R209	1-1/2" RD Relube	Farmhand Hesston	Disc Harrow Disc Harrow
	700613			Kent	Disc Harrow	
	FC0481			Krause	Disc Harrow	
	40-109			Landoll	Disc Harrow	
	1065010011			Unverferth	Disc Harrow	
	91134			White	Disc Harrow	
	W238813			Sunflower		
B15-3189	GW211PP2S DC211TT2S					
B15-3155	L-512-B	DS208TT11	W208PPB11	7/8" Sq. Sealed	Blanton King	Disc Harrow Disc Harrow
	BB2			Long	Disc Harrow	
	990093			Taylorway	Disc Harrow	
	206090			Tuffline	Disc Harrow	
	T603					
B15-3156	G10272	DS208TTR5	GW208PPB5	1-1/8" Sq.	AMCO	Disc Harrow
	A20175			John Deere	Disc Harrow	
	207359			Taylorway	Disc Harrow	
B15-3157	142416BHIMP	DC208TTR17	GW208PP17	1-1/8" Sq. Relube	Bush Hog Bush Hog	Disc Harrow Disc Harrow
	1436183BHIMP					
B15-3158		DC211TTR2	GW211PP2	2-3/16" Rd. Relube	Athens Bush Hog John Deere	Disc Harrow Disc Harrow Disc Harrow
	146244BHIMP			Kewanee	Disc Harrow	
	B2289					
B15-3159	14-50-5	DC210TTR9	GW210PP9	1-15/16" Sq. Relube	Bush Hog	Disc Harrow
B15-3160		DC211TTR14	GW211PPB13	1-3/4" Rd. Relube	Sunflower Miller	Disc Harrow Disc Harrow
B15-3161	20H4027	DS208TT9	W208PPB9	1" Sq. Sealed	Oliver White	Disc Harrow Disc Harrow
B15-3162		DS210TT5	GW210PPB5	1-3/4" Rd. Relube	Krause	Disc Harrow
B15-3163		DS208TT2A	W208PPB2	1-1/2" Rd. Sealed	MF	Disc Harrow
B15-3164	430480	DS211TT2	W211PPB2	2-3/16" Rd. Sealed	Allis Chalmers Case	Disc Harrow Disc Harrow
	H747170			IH	Disc Harrow	
	958334R91			Wilbeck	Disc Harrow	
B15-3165	4050006, 4061005	DS208TTR10	GW209PPB8	1-1/4" Sq. Relube	Lilliston	Disc Harrow
B15-3166	7200460	DS208TTR2	GW209PPB2	1-3/4" Rd. Relube	Ford Kewanee	Disc Harrow Disc Harrow
	B7778			Miller	Disc Harrow	

CASE-INTERNATIONAL DISC REPLACEMENT PARTS



OEM Number	Description	Application	Order No.	Price
468584R2	Bumper Washer	Fits 46, 48, 150, 330, 350, 370, 470, 475, 480, 485, 490, 496	H468584R2	
481611R1	End Washer	Fits Models 132, 150, 330, 350, 370, 470, 475, 480, 485, 490, 610	H481611R1	
HPA4167	End Washer	Fits Models 132, 150, 330, 350, 370, 470, 475, 480, 485, 490, 610	HPA4167	
472592R3	Spool	1-5/8" SQ HOLE 7-1/2". Fits Old Style 37, 46, 48, 60, 61, 120, 122, 130, 132, 150, 350, 370, 470, 480	H472592R3	
472593R3	Spool	3" SQ HOLE 9" SPACING. Fits Old Style 37, 46, 48, 60, 61, 76, 120, 122, 130, 132, 150, 330, 350, 370, 470, 480, 610, 760	H472593R3	
472591R3	Spool	4" SQ HOLE 7-1/2" & 9". Fits Old Style 37, 46, 48, 60, 61, 76, 120, 122, 130, 132, 150, 330, 350, 370, 470, 480, 610	H472591R3	
101189C1	Spool	1-5/8" RD HOLE 7-1/2". Fits New Style 350, 370, 470, 475, 485, 190, 496, 3800 & 3900	H101189C1	
101190C1	Spool	3" RD HOLE 9" SPACING. Fits New Style 132, 350, 475, 485, 490, 496, 3800 & 3900	H101190C1	
101191C1	Spool	4" RD HOLE 7-1/2" & 9". Fits New Style 132, 350, 370, 470, 475, 485, 490, 496, 3600 & 3900	H101191C1	
481416R1	Spool	7-1/2" SQ HOLE. Fits Models 46, 48, 60, 61, 120, 122, 130, 132, 150, 330, 350, 370, 470, 475, 480, 485, 490 & 496	H481416R1	
481417R1	Spool	9" SQ HOLE. Fits Models 37, 46, 48, 60, 61, 120, 122, 130, 132, 150, 330, 350, 370, 470, 475, 480, 485, 490 & 496	H481417R1	
139918C1	9" Spool	1-1/2" RD HOLE. Fits Models 3800, 3900 & 3950	H139918C1	
549977R1	4-1/8" Spool	1-1/2" SQ HOLE. Fits Models 500, 501 & 596	H549977R1	
652383R1	5-1/16" Sleeve	Fits Models 470 & 480 (11 ga. tubing)	H652383R1	
472594R1	6-1/16" Sleeve	Fits Models 470 & 480 (11 ga. tubing)	H472594R1	
652412R1	7-1/4" Sleeve	Fits Model 490 (11 ga. tubing)	H652412R1	
112410C1	8-3/4" Sleeve	Fits Model 470, 475, 480, 485, 490 & 495 (11 ga. tubing)	H112410C1	
129532C2	Holder	Fits Models 490, 496, 3800 & 3900	H129532C2	
483139R92	Scraper LH	Fits 480	H483139R92	
483140R92	Scraper RH	Fits 480	H483140R92	
121119C92	Scraper RH	Fits Models 475, 90, 496, 3900	H121119C92	
121120C92	Scraper LH	Fits Models 475, 90, 496, 3900	H121120C92	



OEM Number	Description	Application	Order No.	Price
A20621/N241315	Spool 1-7/8"	Fits Models With 7-1/4" & 9" Spacing. New Style	HA241315	
A20622/N241318	Spool 3-7/8"	Fits Models With 7-14" Spacing	HN241318	
A37023/N241314	Spool 5-1/2"	Fits Models With 9" Spacing. New Style	HN241314	
A37024/N241320	End Washer		HN241320	
AN183629	Double Spool	Fits Models With 9" Spacing. Heavy Duty	HAN183629	
A20648	Sleeve 8-7/16"	Fits Models With 9" Spacing	HA20648	
A28474	Wear Guard	Fits Models With 630 Disc Bearing, JD 400, 600, 610 & 810 Finish Harrows.IH, Noble & Wil-Rich Do-Alls	HA28474	
A20006	Blade Scraper	Fits Models 110, 111, 115, 210, 220, 230	HA20006	
A38364, N242551	Blade Scraper	Fits Models 215, 235 & 630	HA38364	
N242189	Scraper Spring	For HAP38364	HN242189	
AN240886	Scraper Arm RH	Fits 630, 640, 215, 235, 627, 635, 637	HAN240886	
AN240887	Scraper Arm LH	Fits 630, 640, 215, 235, 627, 635, 637	HAN240887	
AA30941	Disc Gang Bearing Kit	Fits Models 210, 215, 220, 230, 235, 621, 630, 635 & 637	HAA30941	
AA28184	Disc Gang Bearing Only.	Fits Models 210, 215, 220, 230, 235, 621, 630, 635 & 637	HAA28184	
A34792	Flange W/O Zerk	Fits Models 210, 215, 220, 230, 235, 621, 630, 635 & 637	HA34792	
AA27172	Flange W/ Zerk	Fits Models 210, 215, 220, 230, 235, 621, 630, 635 & 637	HAA27172	
A33968	Bearing Flange Gasket	Fits Models 210, 215, 220, 230, 235, 621, 630, 635 & 637	HA33968	
AA30942	Disc Gang Bearing Kit	Fits Models 310, 315, 330, 331, 335, 340, 350, 355, 360, 370, 637, 640, 650, 670, 512 Ripper.	HA30942	

SUNFLOWER DISC REPLACEMENT PARTS - MODEL 1232 DISC W/1-1/2" ROUND AXLE

OEM Number	Description	Order No.	Price
1314-7	Double Spool 7-1/2"	H13147	
2816	Bearing Spool	H2816	
3107	Long Bearing Spool 7-1/2"	H3107	

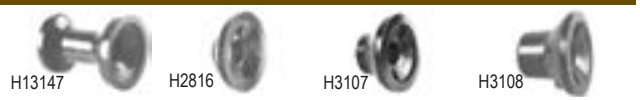

BEARINGS



Water pump type, short shank w/ groove. JD, MF & Noble. Also fits Great Plains, Lilliston/Melroe, Tye, & United Farm Tool Grain Drills. Replaces AN131668, 446612M1, 369851 and 885154B.

Order Number **Price**
B15-0901

Water pump type, short shank w/hole. JD 7000, 7100, 7200, 7300 Planters for both gauge wheel & closing wheel. Also fits row marker disc assembly. Replaces AA21015, AA35741, GA2022 and 885152. White 5100, 5700 Series Gauge Wheels.

Order Number **Price**
B15-0902



Water pump type, double end - smooth. Noble and early model Glencoe Cultivator. Also fits Crust-buster, Tye, Great Plains, & United Farm Tool Grain Drills. Replaces 601440F1, P6310 and 885118B.

Order Number **Price**
B15-0903



Water pump type, long shank w/ groove. IH, Case and Glencoe cultivators. Replaces 526769R91, T26882, P3573 and 885151E.

Order Number **Price**
B15-0907

BUSHING

Sleeve, used as spacer on Bearing B15-0902. JD planter gauge wheels. Replaces A25915 and GB118.

Order Number **Price**
S44-0003

CLOSING WHEEL ASSEMBLY

Nylon. Agco-White Planters. 1"x12". JD 7000, 7100, MaxEmerge™, Kinzie prior to 1993 with bearing. Replaces AA33297, GA3086, 017630 and AA43899



Order Number **Price**
W29-0160

CLOSING WHEELS

JD 1700 planter, 1530 & 1535 drills, Kinzie planter 93 & Newer with bearing. 1"x12". Replaces AA39968 and GA6434



Order Number **Price**
W26-0166

JD 1700 Series, 7200, 7240, 7300, 7340 MaxEmerge2 planters, 1520, 455, 750 drill. with bearing. 1"x12". .669 axle diam. Replaces AA43898 and AA34211.

Order Number **Price**
W26-0167

GAUGE WHEEL HALVES

All Wheel Halves will accommodate any of the above mentioned bearings.



W29-0150

Replaces Number	Application	Order Number	Price
N187926	Yellow, 2 Req. per assembly, JD. 4x12	W29-0150	
N/A	Off-White, 2 Req. per assembly. IH, Glencoe, Kewanee, Noble, MF, Case, White & others. 4x12	W29-0151	
A22780	Painted Yellow for JD Planter Gauge Wheels. Fits W29-0158 Assy. 4.5x15. JD MaxEmerge™, 750, 1560, 1850 drills.	W29-0163	

GAUGE WHEEL ASSEMBLIES

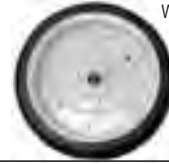

W29-0153

Replaces Number	Application	Order Number	Price
AN130058	Includes tire, Yellow wheel halves & B15-0901 Brg. Used on single arm type cultivators. 4"x12"	W29-0153	
N/A	Includes tire, Off-White wheel halves & B15-0907 Brg. 4"x12"	W29-0154	
N/A	Includes tire, Std-White wheel halves & B15-0901 Brg. MF & Noble. 4"x12"	W29-0155	
N/A	Includes tire, Std-White wheel halves & B15-0903 Brg. Noble and early Glencoe Cultivators. 4"x12"	W29-0156	
AA32046 AA35392 GA2021	Painted Yellow for JD 7000,7100,7200 & 7300 Series Planters. 4.5" x 15". Painted White, Kinzie and Agco-White Planters. 4.5" x 15".	W29-0158 W29-0161	

TIRES



W29-0159

Replaces Number	Application	Order Number	Price
264001	Tire only. 4" x 12", JD, IH, Case, MF, Glencoe, Kewanee, Noble, White, Brillion & others.	W29-0157	
A22884 GD1086 247812B	Tire only for Gauge Wheel for JD 7000,7100,7200,7300 Series Planters, also fits Kinzie, Agco-White, fits W29-0158 & W29-0161 Assembly. 4.5"x15"	W29-0162	
AA22325 GD1085 017632	Tire only for closing wheel on JD, Kinzie and Agco-White Planters. Fits W29-0160 Assembly. 1" x 12".	W29-0159	

8" COVERING DISC FOR CASE-IH & NEW HOLLAND

Fits Case-IH Planters, all 900, 950, 955 and 1200 series; 5400, 5500 Soybean Special; New Holland SP280, SP380 & SP580. Includes blade, bearing retainer, rivets and dust cap. Replaces 1277891C91.



Order No. **Price**
H1277891C91

TILLAGE



BEARING
7/8" hex bore. Has curved O.D. used on seed and fertilizer drives. Replaces JD no. AA22097.

Order No: HAA22097



BEARING
7/8" hex bore. Has flat O.D. Replaces JD no. AA28271.

Order No: HAA28271



BEARING
For clutch actuator shaft. 9/16" hex bore. Fits 7000 flex fold, 7200 & 1750. Replaces JD no. AA34259.

Order No: HAA34259



BEARING
Closing wheel bearing for John Deere Model 7200, 7300 and IHC mode 296 & 386 planter, Bore Size: 0.669" round, O.D: 1.574" flat, IR width: 0.55", OR width : 0.472".

Order No: HAA35638



BEARING
Bearing with cross hole to fit gauge wheel assemblies. Has a 40 mm O.D. to eliminate the use of the bearing spacer.

Order No: HAA35951B



BEARING
Double row ball bearing with 5/8" ID for closing & gauge wheel. Double Row Angular Contact Planter Bearing.

Order No: HAN212132



BEARING
Ball bearing, ID: 15mm (.59"), OD: 42mm (1.65"), Width: 22mm (.87")

Order No: HCJ13975



BEARING
204 series seed opener bearing, 5/8" hole. Fits multiple planter openers including JD, White, and Kinze. Bearing for Crustbuster openers. Replaces No's 400580 & 401042. 2 used per opener on Crustbuster All Plant series.

Order No: HAA21480



BEARING/SPROCKET
Bearing with 19 tooth sprocket, 7/8" hex bore, 2-1/8" width. Used on 7200-7300 and 1700 series planters row unit and planter drive line. Replaces JD no. AA36212.

Order No: HAA36212



BEARING/SPROCKET
Bearing with 19 tooth sprocket, 7/8" hex bore, 1-1/2" width. Used on John Deere 7200, 7300 and 1700 series planters row unit and planter drive line.

Order No: HAH133868



BEARING/SPROCKET
Planter Drive Sprocket - 9/16" hex. Fits 7000, 7100, Max Emerge, 7100 Soybean Special.

Order No: HAA30654



BEARING/SPROCKET
Sprocket and bearing with standard for row unit. 19 tooth fits 7300 JD 7200 and 1700 series planters. Replaces JD no. AA35645. Hub width is 3.25"

Order No: HAA35645



IDLER
Plastic idler the diameter is 2-1/4", for drive wheels, will replace John Deere A22628.

Order No: HA22628



SPACER
Fits models John Deere 7200, 7300, 7240, 1760, 1780, 1700 XP series.

Order No: HA43610



SPROCKET
Fits 1700 Series Planters and attachments. Finger pickup and vacuum meter drive. Plateless herbicide and insecticide drive. Replaces A55008.

Order No: HA55008



SPRING
Standard down pressure spring for John Deere planters. bolts to side of parallel arms. Two or four used per row. Replaces JD no. A43609. Used on Max Emerge & Max Emerge Plus.

Order No: HA43609



SPRING
Heavy duty down pressure spring with plug. Replaces JD no.'s AA28046 and AA35876; Kinze no GA2068. Also used on Kinze contact drive wheels.

Order No: HAA35876



SPRING
Idler arm spring for Herbicide/Insecticide drive. Replaces JD no. A49644. Used on 1700, 7200 and 7300 series.

Order No: HA49644



BUSHING
For closing wheel arm. Replaces H2204B

Order No: HA2204



BUSHING
For closing wheel arm. 2 Required. Fits MaxEmerge Plus, Pro, XP Pro, 1530 and 1535. Replaces A55888.

Order No: HA55888



BUSHING
For Parallel arms on John Deere 7000 - 7100; Kinze 2000 Series. Replaces A23789 and GB0218

Order No: HA23789



BUSHING
Self-aligning bushing. Fits 1700, 1710, 1720 Series Planters and attachments. Replaces AA57058.

Order No: HAA57058



BUSHING
Cam bushing, right hand. For closing wheel arm. Fits 7300 Series MaxEmerge 2 Planters. Replaces A48430.

Order No: HA48430



CLOSING WHEEL ARM
Cast closing wheel arm for John Deere Max Emerge Plus, PRO, XP PRO, 1530, 1535 series.

Order No: HA86763



CLOSING WHEEL ARM
Closing wheel arm for John Deere 7000, 7100. Replaces JD no. AA31217. Can be used to replace Kinze GA6056.

Order No: HAA31217



CLOSING WHEEL ARM
Closing wheel arm for John Deere 1760, 1780, 7200, 7300, 7340 planters. Replace JD numbers AA37552 & AA37839. Comes with spindles for wheels.

Order No: HAA37552



CLOSING WHEEL ARM STOP
Cast iron closing wheel arm stop, painted green. Fits 7000, 7100; Kinze (except 3000 series). Replaces JD No A28135, A33879; Kinze No GB0113.

Order No: HA33879



HANDLE
Handle for closing wheel arm on John Deere Max Emerge® 2, Plus, Pro, and XP row units. Replaces JD number A64237.

Order No: HA64237



SPACER
For closing wheel arm. 2 per arm. Replaces A52556. Fits 7200, 7300, Max Emerge 2, 1760, 1780 and Max Emerge Plus.

Order No: HA52556



SPRING
Closing wheel spring for John Deere Model 1760, 1780 7200, 7300 MaxEmerge 2and 7340. Coiled part is 3 3/4", overall length is 7".

Order No: HA74643



STOP
John Deere XP planter stop.

Order No: HA82772



COVERING DISC - 8"
Fits 7200, 7300 series. Original style. Includes bearing, rivets disc openers, seed blade, bearing, retainer and bolt. Replaces AA33061 and AA58321.

Order No: H58321



DUST CAP
Dust Cap for seed bearing housing. 1-1/2" diameter. Used on AA55927, AA37474

Order No: HA52024



DUST CAP
Dust cap for seed disc opener, smaller cap diameter 1-1/4".

Order No: HAG78218



BOLT
Pivot bolt for walking gauge wheel. Fits John Deere MaxEmerge®Plus, Pro, XP Pro, 1530 and 1535. Also late John Deere MaxEmerge®2 planters.

Order No: HA58670

TILLAGE



BOLT & WASHER KIT
Fits 1700, 1710, 1720 Series Planters. Replaces AA54179.

Order No: H54179BW



GAUGE WHEEL ASSEMBLY
Fits model 7000 series planters, black nylon/ steel wheel halves w/885154b bearing & G25915 bearing spacer.

Order No: HAA41359



GAUGE WHEEL ARM KIT
Has threaded bushing for proper adjustment of the gauge wheel to the seed disc opener. Updates older planters to the new style arm design. Comes with two different threaded bushing, one for older series of planters and one for the newer series.fit models JD 7100, 7200, 7300 & Max Emerge 1760, 1780, 1700, 1710, 1720 series Planters.

Order No: H25502B



PIN
For planter arm, work with A69141.

Order No: HAA55143



PIVOT STOP KIT

Fits MaxEmerge Plus, Pro, XP, XP Pro, 1530, 1535, also late MaxEmerge, including: A82772 John Deere XP planter stop, A62609 John Deere XP planter rocker, A58670 John Deere XP planter pivot bolt.

Order No: HA62609K



ROCKER

For walking gauge wheel. 3/4" pivot hole and built-in pivot stops. Fits MaxEmerge®Plus, Pro, XP Pro, 1530, 1535. OEM No.:A62609

Order No: HA62609



TIRE

4.5" x 16" tire with standard profile offset. Fits John Deere planters XP, XP Pro row units; 1530, 1535 with XP.

Order No: HA84062



SCRAPER ASSEMBLY - LEFT

Fits John Deere 7000, 7100 MaxEmerge; 7200, 7300 and 1700 Planter with MaxEmerge 2 and MaxEmerge Plus Row Units; Kinze. Replaces AA26444 and GA2012L

Order No: HAA26444L



SCRAPER ASSEMBLY - RIGHT

Fits John Deere 7000, 7100 MaxEmerge; 7200, 7300 and 1700 Planter with MaxEmerge 2 and MaxEmerge Plus Row Units; Kinze. Replaces AA26443 and GA2012R.

Order No: HAA26443R



SCRAPER

Heavy duty seed blade scraper for planter parts, model 7200, 7300, 1760, 1780. For use in sticky soils.

Order No: HA62182



SCRAPER KIT

Tungsten carbide edge. Fits John Deere 1530, 1535, 1700, 1720, 1730, 1760, 1780, 1790, 7100, 7200, 7300, 7340. Kit includes 1 LH and 1 RH Scraper, 1 spring and 2 hairclips. Replaces AA62808.

Order No: HAA62808



SCRAPER KIT

Fits John Deere 1530, 1535, 1700, 1720, 1730, 1760, 1780, 1790, 7100, 7200, 7300, 7340. Kit includes 1 LH (nylon covered), 1 RH Scraper Arm, 1 Spring, 2 Cotter Pins. Replaces BA28945.

Order No: HAA37221K
Rotating Scraper Wheel Only
HAA37221



SCRAPER PIN

Fits John Deere 1760, 1780, 7200, 7300 Planters. Replaces A64447.

Order No: HA64447



SPRING

Tension left hand spring for heavy duty scraper, for John Deere 1700 series planter units and attachments.

Order No: HA41116



SPRING

Tension right hand spring for heavy duty scraper, for John Deere 1700 series planter units and attachments.

Order No: HA41117



SPRING

Fits Rotating Scrapers and Tungsten Carbide Scrapers. Replaces A50047.

Order No: HA50047



OPENER GUARD

Fits 7200 and newer planters. Replaces JD no. A48879. Fits 7200, 7330, Max Emerge 2, 1760, 1780, Max Emerge Plus, XP.

Order No: HA48879



SEED GUARD

Fits John Deere 1760, 1780 (before 2/97); 7000, 7100, 7200. Replaces A41692.

Order No: HA41692



SEED TUBE

Fits John Deere 1700 series planters. Regular curve with large monitor hole. Replaces A74934.

Order No: HA56784



SEED TUBE

Fits John Deere 7200, 7330, 7340 series planter. Small monitor hole. Replaces A55880.

Order No: HA55880



SEED TUBE

Fits John Deere 1720 SP Series. Large hole size tie straps. Replaces AA67780.

Order No: HAA67780



SEED TUBE CLIP

For JD 1785 & 1985 XP. Will replace JD A55984, AP00178 clip.

Order No: HA55984



SEED TUBE PROTECTOR

For XP row units

Order No: HA80203



SUPPORT

Support, seed guard, replace A54868. Fits 7200, 7300 Max Emerge 2, 1760, 1780, Max Emerge Plus, 7000, 7100, Pro Series.

Order No: HA54868

BUSHING

Closing wheel arm eccentric bushing for GA8322 Arm, heat treated. Zinc plated.



Order No: HGB0239

BUSHING

Closing wheel arm hex stepped bushing for G8322 arm, heat treated.



Order No: HGB0282

CLOSING WHEEL ARM

Closing wheel arm for Kinze built 1993 and later. For use with bolt on wheels. Replaces Kinze GA8322.



Order No: HGA8322

GAUGE WHEEL ARM

Planter gauge wheel arm for Kinze. Has thread hole at the bottom to attach the gauge wheel. Has threaded bushing at the top for adjusting the gauge wheel to the seed disc opener.



Order No: HGA6614

LEVER

Closing wheel adjusting lever; Kinze 1993 and newer.



Order No: HGB0254

SPRING

New style down pressure spring for quick adjust. Fits Kinze only.



Order No: HGD8429

PLANTER TALC AND GRAPHITE

TALC POWDER

- Maximizes yield and profit by increasing plant population per acre.
- Reduces moisture generated by vacuum planters.
- Helps prevent "bridging" of seeds in planter by reducing moisture.
- Helps seed flow smoothly and evenly through vacuum meter planters.
- Reduces wear on vacuum meter components.

Size	Order No.	Price
8 lb Jug	A 735300	
20 lb Box	A 735301	
20 lb Bucket	A 735302	



80/20 TALC GRAPHITE

- Designed exclusively for treated seed.
- Increases planting efficiency and maximizes yield per acre.
- Use in both "gravity flow" and "air" planters.
- Reduces moisture issues, lubricates seed and equipment.
- Helps prevent "seed bridging" in the planter.
- High-purity for less meter wear.
- Non-toxic
- Apply 4-6 oz each time hopper is filled with seed.

Size	Order No.	Price
8 lb Jug	A 735307	
20 lb Box	A 735308	
20 lb Bucket	A 735309	



Low Drift 80/20

12 lb Jug	A 735310
-----------	----------

50/50

12 lb Jug	A 735311
-----------	----------

GRAPHITE POWDER

- Maximizes yield and profit by increasing plant population per acre.
- Easiest, most convenient way to apply seed-flow lubricant. No buildup.
- Helps prevent "bridging" of seeds in the planter.
- Helps seed flow smoothly and evenly through high-speed planters.
- Reduces wear on planter plates.

Size	Order No.	Price
1 lb Bottle	A 735304	
5 lb Jug	A 735303	
20 lb Box	A 735305	
20 lb Bucket	A 735306	



EZ-MEASURE FLIP LID

New lid allows application with minimal human or wind exposure and gives precise amount measurements. Measures in 1/8 cup increments. Fits 5 lb jugs.



Order No: A 735312

FERTILIZER DISC OPENERS

MADE IN THE USA! Made From High Quality Boron Steel. Includes hub & bearing.

Replaces	Description	Order No	Price
AA57466	13.5" x 3mm Fertilizer Opener Assembly Fits JD 7000 - 7100 MaxEmerge, 7200 - 7300, 1700, DB Series that mounts to fertilizer bar	HAA57466	
	13.5" x 2.54mm Fertilizer Opener Assembly Fits JD 7000, 7100, 7200, 7300. Dust cap required pn 0475-02935*	B45-3194A	

*Herschel assembled in the USA.

COULTER BLADES

Fits **John Deere** Max Emerge. 6 hole, 3.5" bolt circle.

Replaces	Size/Description	No. Of Waves	Order No	Price
-	16" x 4MM Wavy	12	B45-1123*	
A73911	16" x 4MM Wavy	8	B45-1125	
-	16" x 4MM Spherical	24	B45-1126	

Fits **John Deere** Max Emerge 2, Plus, Pro, XP, XP Pro, ME5 and Exact Emerge. 5 hole, 4.75" bolt circle.

Replaces	Size/Description	No. Of Waves	Order No	Price
A73615	16" x 4MM Wavy	8	B45-1127	
A72678	16" x 4MM Wavy	12	B45-1122*	

*Brazil Made



Made In The USA

ROW CROP CULTIVATOR SWEEPS

Punched with three holes - two on 2" centers for 7/16" x 1-3/4" bolts and the center hole is square for a 5/8" x 1-3/4" carriage bolt. The high speed row crop sweep

is made with a 54 degree shank angle. The wings have been flattened and the crown lowered which allow for higher speeds and less dirt being pushed on the crops. Used on the Allis Chalmers field cultivator, the Forrest City Du-All dual tillage machine and the Buffalo No-Till cultivator, Case, Cockshutt 237, 239, 337, and Minntoba LDC 726-729. 3/16" thickness. Uses 7/16 x 1-3/4" #3 Plow Bolt.

Size	Description	Order No.	Price
4"	Plain, Full	22404	
6"	Plain Full	22406	
6"	Hardfaced Bottom Side, Full	22406H	
8"	Plain	22408	
8"	Hardfaced Bottom Side, Full	22408H	
10"	Plain	22410	
10"	Hardfaced Bottom Side, Full	22410H	
12"	Plain, Full	22412	
12"	Hardfaced Bottom Side, Full	22412H	
14"	Full	22414	
14"	Hardfaced Bottom Side, Full	22414H	
16"	Full	22416	
18"	Hardfaced Bottom Side, Full	22416H	
18"	Plain, Full	22418	
20"	Plain, Full	22420	
22"	Plain, Full	22422	
24"	Plain, Full	22424	
26"	Plain, Full	22426	
28"	Plain, Full	22428	
30"	Plain, Full	22430	



Made In The USA

FIELD CULTIVATOR SWEEPS

924 Series will fit Bourgault, Crustbuster, DMI, Harris, Hesston, Hiniker, IHC Vibra Shank, Ingham, John Deere 960 Series, Kent, Kewanee, Landoll, Massey Ferguson, Sunflower and Wilrich. **Requires 7/16" no. 3 head bolts. 1-3/4" hole spacing. 1/4" thick. 47° Stem angle.**

934 Series will fit Anderson, Bush Hog, CCIL 179, 379 and Z, Case FC, FCM and FCSW, Cockshutt 285 and 485, Ford 208, Glencoe 101, Kewanee, Krause 600 and 900, Leon Vibra Flex Massey Ferguson 160, Minneapolis Moline FT 200, Morris L240 and L320, Oliver 285, 385 and 485, Taylor, and White. **Requires 3/8" x 1-1/4" no. 3 head bolts. 1-3/4" hole spacing. 1/4" thick. 47° Stem angle.**

944 Series will fit Allis (early models), Baker, Brady (prior to 70-71), Brillion (prior to 1986), Cockshutt (early models), Deere (CCA, CC10, CC20, and 1000 Series, Glencoe (1250 double shank), Krause (k-tine), and Oliver (245 and 345). **Requires 3/8" x 1-1/4" no. 3 head bolts. 1-5/8" to 1-3/4" hole spacing. 1/4" thick. 41° Stem angle.**

924 SERIES

Size	Description	Order No	Price
4"	Plain	92404	
4"	Hardfaced Top Side	92404H	
6"	Plain	92406	
7"	Plain	92407	
7"	Hardfaced Top Side	92407H	
8"	Plain	92408	
8"	Hardfaced Top Side	92408H	
9"	Plain	92409	
9"	Hardfaced Top Side	92409H	
9"	Hardfaced, Inserted	92409H81	
10"	Plain	92410	
10"	Hardfaced Top Side	92410H	
10"	Hardfaced, Inserted	92410H81	
11"	Plain	92411	
11"	Hardfaced Top Side	92411H	
11"	Hardfaced, Inserted	92411H81	
12"	Plain	92412	
12"	Hardfaced Top Side	92412H	
12"	Hardfaced, Inserted	92412H81	

934 SERIES

Size	Description	Order No	Price
4"	Plain, Slotted Hole	93404S	
6"	Plain	93406	
6"	Hardfaced	93406H	
7"	Plain	93407	
8"	Plain	93408	
8"	Hardfaced	93408H	
9"	Plain	93409	
9"	Hardfaced	93409H	
10"	Plain	93410	

944 SERIES

Size	Description	Order No	Price
4"	Plain	94404	
6"	Plain	94406	
7"	Plain	94407	
9"	Plain	94409	
9"	Hardfaced, Inserted	94409H81	
10"	Plain	94410	
11"	Plain	94411	
11"	Hardfaced	94411H	

*3/16" Thick

TILLAGE



JOYCE SWEEPS

Used Primarily in California and Arizona for Cultivation of Cotton and Potatoes. Higher Crown and Wing Lift for Greater Soil Disturbance than the 224 Series Sweeps. 55 degree stem angle.

Punched with three holes - two on 2-1/4" centers for 7/16" x 1-3/4" bolts and the center hole is square for a 5/8" x 1-3/4" carriage bolt. **Made In The USA**

Size	Full, Right, or Left	Order No.	Price
6"	Plain, Full	44406	
6"	Hardfaced, Full	44406H	
8"	Plain, Full	44408	
8"	Hardfaced, Full	44408H	
10"	Plain, Full	44410	
10"	Hardfaced, Full	44410H	
12"	Plain, Full	44412	
12"	Hardfaced, Full	44412H	
14"	Plain, Full	44414	
14"	Hardfaced, Full	44414H	
14"	Hardfaced, Inserted, Full	44414H81	
16"	Plain, Full	44416	
16"	Hardfaced, Full	44416H	
16"	Hardfaced, Inserted, Full	44416H79	
18"	Plain, Full	44418	
18"	Hardfaced, Full	44418H	
20"	Plain, Full	44420	
22"	Plain, Full	44422	
22"	Hardfaced, Inserted, Full	44422H79	
24"	Plain, Full	44424	
24"	Hardfaced, Full	44424H	

ALABAMA SWEEPS

All Alabama Sweeps are punched with 3 holes. Two holes for 7/16" plow bolts on 2-1/4" centers and one square hole, centered for 5/8" carriage bolt.



Material Thickness	Stem Angle	Bolt Size	Hole Spacing
1/4"	55°	7/16" & 5/8"	2-1/4"

Size	Description	Order No.	Price
12"	Plain	51H12	
12"	Hardfaced	51H12H	
14"	Plain	51H14	
14"	Hardfaced	51H14H	
16"	Plain	51H16	
16"	Hardfaced	51H16H	
18"	Plain	51H18	
18"	Hardfaced	51H18H	
20"	Plain	51H20	
20"	Hardfaced	51H20H	
22"	Plain	51H22	
22"	Hardfaced	51H22H	
24"	Plain	51H24	
24"	Hardfaced	51H24H	



CULTIVATOR SHANK CLIP FOR IHC

Replaces no. 511985-R21. Fits 252 Cub, Cub 3 cultivators no. C-244, 254, 452, 652, 647, 2C254A and K-254. Also fits all C, Super C and Super A cultivators.

Description	Order No.	Price
Shank Clip	A 484964	
Wedge Bolt/Nut	A 485128	

PEANUT BLADES

Fits KMC, Lilliston, Amadas and Others. Sold in pairs (1 Left, 1 Right). Requires 3/8" #3 Plow Bolts.



Length	Thickness	# Of Bolts	Order No	Price
42"	3/8"	3	PNB	

FURROWERS HIGH BACK 400 SERIES

Heat treated boron steel for long life. 1/4" Thick. 7/16" Bolt Size for plow bolts. 1-1/4" to 2-1/4" hole spacing.

Width Bottom	Order No	Price
10"	410	
10"	410H	
12"	412	
12"	412H	
15	415	
15	415H	
18	418	
18	418H	



FURROWERS - 600 SERIES

All 600 Series Furrowers are punched with 3 holes. Two holes for 7/16" plow bolts on 2-1/4" centers and one square hole, centered for 5/8" carriage bolt. Made from 1080 High Carbon Steel. Heat Treated for Longer Wear.



Material Thickness	Bolt Size	Hole Spacing
1/4"	2) 7/16" Plow Bolts or 1) 5/8" Carriage Bolt	2-1/4"

Size	Width Bottom	Width Top	Description	Order No	Price
6"	6"	9.25"	Plain	608	
6"	6"	9.25"	Hardfaced	608H	
8"	8"	9.5"	Plain	610A	
8"	8"	9.5"	Hardfaced	610H	
8"	8"	9.5"	Hardfaced, Inserted	610H60	
10"	10"	14"	Plain	612	
10"	10"	14"	Hardfaced	612H	
10"	10"	14"	Hardfaced, Inserted	612H60	
12"	12"	15"	Plain	615	
12"	12"	15"	Hardfaced	615H	
12"	12"	15"	Hardfaced, Inserted	615H60	
15"	15"	20"	Plain	618	
15"	15"	20"	Hardfaced	618H	

FURROWERS - LISTER SHARES

All Lister Style Furrowers are punched with 1 square hole, centered for 3/4" carriage bolt. Made from 1080 High Carbon Steel. Heat Treated for Longer Wear.



Material Thickness	Bolt Size	Hole Spacing
1/4"	3/4"	Centered

Size	Description	Order No	Price
12"	Plain	1012	
14"	Plain	1014	
15"	Plain	1015	

LISTER SHARES

Made from 1080 High Carbon Steel. Heat Treated for Longer Wear.



Material Thickness	Bolt Size
5/16"	4) 3/8" X 1-1/4"

Center Hole		Application	Order No	Price
Width	Spacing			
14"	4-1/2"	John Deere	287	

HEEL SWEEP

Thickness: 1/4"
Width: 18"
Shank: 50 degrees
Holes: 2 holes 1/2" slotted
Hole Spacing: 2-1/4" to 2-1/2"



Application: Fits over top of a chisel plow shank and is used in conjunction with a chisel point being bolted on over the top of this heel sweep. Our CB75 or HA13S would be popular choices for this.

Benefits: Provides cultivating and chiseling in the same pass. It can also be used in manure application in some areas.

Order No	Price
HEEL18	

TERMINATOR II SWEEPS

1/4" thickness. 47 degree stem. 7/16" bolt size. 1-3/4" hole spacing. Contoured wings provide better soil disturbance across entire sweep for improved weed control. Extended sweep point improves soil penetration. Hammer-lock sweeps use clips listed below.



Made In The USA

Size	Description	Order No.	Price
7"	Bolt-On	S85-0515	
7"	Hammer-Lock	S85-0537	
9"	Bolt-On	S85-0516	
9"	Hammer-Lock	S85-0539	
10"	Bolt-On	S85-0517	
10"	Hammer-Lock	S85-0540	

- Sweep point is 5/8" longer than Terminator I Sweeps for improved soil penetration.
- Contoured wings are 7/16" wider than Terminator I Sweeps which results in better soil action.
- Clipped style wings maintain full cutting width and prolonged sweep life.
- Hammer-Lock design eliminates unbolting and rebolting.
- Accurately fits Empire and McKay mounting clips.

HAMMER-LOCK SWEEP

Constant Width. 49 degree stem angle. 1/4" Thickness. Use clips listed below.

Size	Description	Order No.	Price
4"	Plain	S85-0404	
7"	Plain	S85-0405	
9"	Plain	S85-0406	
10"	Plain	S85-0407	

Made In The USA



HAMMER-LOCK SWEEP

Constant Width. 41 degree stem angle. 1/4" Thickness. Use clips listed above right.

Size	Description	Order No.	Price
4"	Plain	S85-0410	
7"	Plain	S85-0411	
9"	Plain	S85-0412	

Made In The USA



MOUNTING CLIP FOR HAMMER-LOCK SWEEP

Install clip only once when using hammer-lock designed sweeps.

Replaces No.	Bolt Size	Hole Spacing	Order No.	Price
LKM-6	3/8"	1-5/8" - 1-3/4" Slotted	C45-0407	
LKM-7	7/16"	1-3/4" - 2" Slotted	C45-0408	

Made In The USA



SLIM SHANK SPOONS & SWEEPS

Designed to leave field smoother. For use on Air Seeders and Field Cultivators. Full width clipped wings.



Size	Description	Order No	Price
2"	Seeder Spoon	S85-0522	
3"	Seeder Spoon	S85-0523	
9"	Sweep, Plain, 47° Shank	S85-0519	
10"	Sweep, Plain, 47° Shank	S85-0520	
11"	Sweep, Plain, 47° Shank	S85-0521*	
	Clip, Slim Shank, Flat Back, Fits Bourgault, E-Z On, and works with McKay Sweeps. Uses 1/2" Hex Bolts for installation.	C45-0409	
	Clip, Slim Shank, Curved Back, Fits CCIL 200, Degelman, Flexi-Coil, JD 960 & 985, Leon, MF 160 & 259, Morris, Wilrich, and works with McKay Sweeps. Uses 1/2" Plow Bolts for installation	C45-0410	

DANISH SWEEPS

1/4" thickness. Designed to fit Danish S-Tine and other field preparation equipment of this type. Require 3/8" x 1-1/2" elliptical head bolt (H10 type). Dimple to protect bolt head. Heat-treated. **Made In Iowa.**



Description	Style	Order No	Price
1-1/2" point	A	S32-0001*	
2-3/4" duckfoot	B	S32-0016	
4" duckfoot	C	S32-0017	
4" v-design	D	S32-0018	
7" sweep	E	S32-0019	
9" sweep	E	1409A	

*Imported

DANISH TINES / S-TINES

S-Tines and clamps are made to demanding OEM specifications. Tines are constructed of high quality steel with rounded edges - shot peened and painted black. For all S-Tine Danish Cultivators.



Replaces Number	Size	Description	Order No	Price
P5215	3/8" x 22" x 1-1/4"	Standard	T16-0001	
P5315	1/2" x 22" x 1-1/4"	Heavy Duty	T16-0003	
P5415	1/2" x 26" x 1-3/4"	HD, Long	T16-0004	

CLAMPS FOR DANISH TINES/S-TINES



C41-0004

Size	Fits S-Tine No.	Replaces	Order No.	Price
2" x 2". 1-3/8" Slot.	T16-0001	J24	C41-0004	
2-1/2" x 2-1/2". 1-3/8" Slot	T16-0003	T260	C41-0011	
2" x 2". 1-7/8" Slot	T16-0003	J28	C41-0028	

DANISH SWEEPS - HARDFACED

1/4" Thick. 3/8" x 1-3/8" bolt hole. Requires H10 bolt type. Heat-treated. Made of of 10B22 Boron steel with a black finish. Excellent for high speed cultivation.



1401H

Size	Description	Style	Order No	Price
1-1/2" x 7-1/4"	Reversible Point	A	1401H	
2-3/4"	Duckfoot	B	1403H	
4"	V-Design	D	1404H	
7"	Sweep	E	1407H	

WING SWEEPS - V-PLOW BLADES

5/16" Thick. 1/2" X 1-1/2" #3 Bolt. 75 degree angle. Eagle Beak, Chrome Alloy Point. Rod Hard-Faced. Clipped Wing. **Made In The USA!**



Fits Noble, Krause, Flex King, TriFlex, ARK Valley, Sunflower, Richardson, Bush Hog, John Deere, Hayhawk, Vasser, Davies and Miller.

Size	Description	Order No	Price
5'	Hard-Faced Bottom Side, Inserted	05HBSCP	
5'	Hard-Faced Top Side, Inserted	05HTSCP	
5-1/2'	Hard-Faced Bottom Side, Inserted	055HBSCP	
5-1/2'	Hard-Faced Top Side, Inserted	055HTSCP	
6'	Hard-Faced Bottom Side, Inserted	06HBSCP	
6'	Hard-Faced Top Side, Inserted	06HTSCP	
6-1/2'	Hard-Faced Top Side, Inserted	061/2HTSCP	
7'	Hard-Faced Top Side, Inserted	07HTSCP	

KENT PLAINS PLOW SHARES

Shallow Pitch. Eagle Beak, Chrome Alloy Point. Rod Hard-Faced. **Made In The USA!**



Size	Description	Order No	Price
4"	Top Side HF	04KSHSTSCP	

WHEATLAND (CHISEL PLOW) SWEEPS 22 SERIES

1/4" thickness with a 50° stem angle. Uses a 7/16" bolt. 2-1/4 hole spacing. Medium crown. Constant width.



1022

Designed to fit Anderson, Case-High Clearance, Cockshutt, CCIL, Degelman, Frigstad, Glencoe, Graham - 600 Series, John Deere - 650, 1100, 1600, Krause, Landoll, Massey, Mel-Cam, White and Others With 22" Shanks.

Size	Description	Order No	Price
10"	Plain	1022C	
12"	Plain	1222C	
14"	Plain	1422C	
16"	Plain	1622C	
18"	Plain	1822C*	
18"	Hard-faced, Bottom Side	1822CH	

WHEATLAND (CHISEL PLOW) SWEEPS 22G SERIES

1/4" thickness with a 47° stem angle. Uses a 7/16" bolt. 2-1/4 hole spacing. Medium crown. Constant width.



1422G

Designed to fit Anderson, Case, Glencoe, Geisler and Massey-Harris.

Size	Description	Order No	Price
14"	Plain	1422GC	
16"	Plain	1622GC	

WHEATLAND (CHISEL PLOW) SWEEPS 225G SERIES

1/4" thickness with a 47° stem angle. Uses a 1/2" bolt. 2-1/4 hole spacing. Medium crown. Constant width.



Designed to fit Anderson, Case, Glencoe, Geisler and Massey-Harris.

Size	Description	Order No	Price
14"	Plain	14225GC	
16"	Plain	16225GC	
18"	Plain	18225GC	

WHEATLAND (CHISEL PLOW) SWEEPS IH SERIES

1/4" thickness with a 43° stem angle. Uses a 1/2" bolt. 2-1/4 to 2-1/2" hole spacing. Medium crown.



Designed to fit IHC models 10, 50, 55; CCIL 203 & 204, Morris and Wilrich

Size	Description	Order No	Price
8"	Plain	IH08C	
10"	Plain	IH10C	
12"	Plain	IH12C	
14"	Plain	IH14C	
16"	Plain	IH16C	
16"	Hard-Faced. Bottom Side	IH16CH	
18"	Plain	IH18C	
18"	Hard-Faced. Bottom Side	IH18CH	

CHISEL SWEEPS - CS SERIES

5/16" thickness with a 50° stem angle. 2-1/4" hole spacing.



Use in place of chisels for more soil movement.

Size	Description	Bolt Size	Order No.	Price
6"	Plain	7/16"	CS06	
7"	Plain	1/2"	CS505	
7"	Hard-Faced. Top Side	1/2"	CS505H	
7"	Hard-Faced. Bottom Side.	1/2"	CS505HBS	

QUINSTAR LAZER PLOW SHARES

4" Bottom Side Hard-Face.

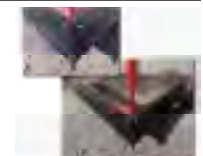

Order No	Price
04QBSCP	

WHEATLAND (CHISEL PLOW) SWEEPS 225 SERIES

1/4" thickness. 50 degree stem. 1/2" bolt size. 2-1/4" hole spacing. Medium crown. Constant width. Designed to fit Figstad, Graham, Hiniker, John Deere, Leon and Mohawk



Size	Description	Order No.	Price
10"	Plain	10225C	
10"	Hard-Faced. Bottom Side	10225CH	
12"	Plain	12225C	
14"	Plain	14225C	
16"	Plain	16225C	
16"	Hard-Faced. Bottom Side	16225CH	
18"	Plain	18225C	
18"	Hard-Faced	18225CH	
18"	Top Side	18225CHTS	
18"	Hard-Faced. Top Side	18505CHTS	

WHEATLAND (CHISEL PLOW) SWEEPS 516 SERIES

5/16" thickness. 50 degree stem. 1/2" bolt size. 2-1/4" hole spacing. Low crown. Standard wing. Designed to fit Quinstar Follow Master and Sunflower Follow King, Kent and John Deere. Reinforced wings



Size	Description	Insert	Order No.	Price
26"	Plain		26516	
26"	Hard-Faced. Bottom Side		26516H	
26"	Hard-Faced. Top Side		26516HTS	
26"	Hard-Faced. Top Side	79CC	26516H79	

WING SWEEPS

5/16" thick with 3/8" bolt hole. Designed for Hiniker and Kinzie. Will also fit other Ridge Till Cultivators with 8" hole spacing including Buffalo, Krause and Sukup. Reversible with double bevel.

Cutting Width	Description	Order No.	Price
15"	Plain	A5115	
15"	Hard-Faced	A5115H	
17"	Plain	A5117	
17"	Hard-Faced	A5117H	
19"	Plain	A5119	
19"	Hard-Faced	A5119H	
21"	Plain	A5121	
21"	Hard-Faced	A5121H	
23"	Plain	A5123	
23"	Hard-Faced	A5123H	
25"	Plain	A5125	
25"	Hard-Faced	A5125H	
27"	Plain	A5127	
27"	Hard-Faced	A5127H	



POINTS FOR WING SWEEP CULTIVATORS

1-15/16" with 1/2" X 1-1/2" bolt.

Application	Description	Order No.	Price
Sukup	w/93cc Chrome Carbide Cap	A41001	
Hiniker 6000	Carbide Cap	P57-0006	

ALFALFA SPIKES

No Twist. 2-1/4" hole spacing. Reversible.

Size	Bolt	Order No.	Price
3/4" x 2" x 15"	1/2"	17522	
3/4" x 2" x 15"	1/2"	17522H*	

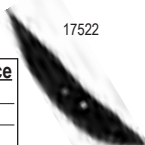

CHISEL POINT WITH INSERT

Chrome carbide insert. 2-1/4" x 2-1/2" Hole spacing.

Size	Bolt	Order No.	Price
3/4" x 2" x 13-1/2"	1/2"	HA13S	



WHEATLAND (CHISEL PLOW) SWEEPS 505 SERIES

1/4" thickness. 50 degree stem. 1/2" bolt size. 2-1/4" hole spacing. Low crown. Constant width. Designed to fit Figstad, Graham, Hiniker, John Deere, Leon and Mohawk



Size	Description	Order No.	Price
16"	Plain	16505C	
16"	Hard-Faced. Bottom Side	16505CH	
18"	Plain	18505C	
18"	Hard-Faced. Bottom Side	18505CH	
18"	Hard-Faced. Bottom Side. Inserted.	18505CHB79	

Standard wing.

Size	Description	Order No.	Price
20"	Plain	20505	
20"	Hard-Faced. Bottom Side. Inserted.	20505HB79	
22"	Plain	22505	
24"	Plain	24505	
26"	Plain	26505	

SPRING TOOTH SWEEPS - STS SERIES

1/4" thickness with a 31° stem angle. 3/8" bolt size. 2" hole spacing. Made from 1080 high tensile steel. Fits Bush Hog, Crustbuster and Calkins. Replaces points on spring tooth harrow and some cultivators.

Size	Description	Order No.	Price
6"	Plain	STS06	



ST11



ST14

SPRING TOOTH POINTS - ST SERIES 11" LENGTH

Plated and sharpened for better wear. Oil quenched and heat treated. Fits field cultivators, spring tooth harrows and row crop cultivators.

Width	Thickness	Bolt Size	Hole Spacing	Description	Order No.	Price
2"	1/4"	3/8"	1-1/4" to 2-1/4"	Plain	ST11	
2"	1/4"	7/16"	1-1/4" to 2-1/4"	Plain	ST12	
2"	1/4"	7/16"	1-1/4" to 2-1/4"	55CC Chrome Carbide Insert	ST12I	
2-1/2"	1/4"	3/8"	1-1/4" to 2-1/4"	Plain	ST13	
1-3/4"	1/4"	3/8"	2"	Plain	ST14	
1-3/4"	1/4"	3/8"	2"	Hard-Faced For Crustbuster & Kent	ST14H	
1-3/4"	5/16"	3/8"	2"	Plain	ST15	
2"	3/8"	3/8"	1-1/4" to 2"	Plain, Heavy Swedged Nose	ST20	
2"	3/8"	7/16"		Plain, Heavy Swedged Nose	ST21	

SPRING TOOTH POINTS - CC SERIES

5/16" Thick. 11" length. 1-3/4" wide. Fits spring tooth harrows, field cultivators and row crop cultivators.



Bolt Size	Spacing	Hole Description	Order No.	Price
3/8"	1-3/8" to 1-3/4"	Plain	CC01	
3/8"	1-3/8" to 1-3/4"	Inserted	CC01I	
7/16"	1-3/4"	Plain	CC03	
7/16"	1-3/4"	Inserted	CC03I	
3/8"	2"	Plain. Fits Crustbuster Drills	CC06	
3/8"	2"	Inserted. Fits Crustbuster Drills	CC06I	

CHISEL POINT - CB SERIES

3/4" Thick. 13" Long. 2" Wide. Will wear up to 10 times longer than plain points. Insert design directs soil flow away from bolt heads. Chromium carbide tips #61 Adalloy.

Bolt	Hole Spacing	Order No.	Price
7/16"	2-1/4"	CB70	
1/2"	2-1/4" to 2-1/2"	CB75	

CB75



CHISEL POINTS AND SHOVELS

Reversible spikes have upset (swedge) points for increased wear and longer life. Even after considerable use, these spikes retain their original shape and stay sharp.

Made In The USA



Size - T x W x L	Bolt Spacing	Bolt Size	Order No.	Price
1/4" x 1-3/4" x 9-1/16"	Single Hole	3/8"	P57-0063	
1/4" x 1-3/4" x 11"	1" to 2"	3/8"	P57-0963	
1/4" x 1-3/4" x 11"	1-3/4"	3/8"	P57-0965	
1/4" x 1-3/4" x 11"	1-3/4"	3/8"	P57-0966	
1/4" x 1-3/4" x 11"	1-3/4"	7/16"	P57-0973	
1/4" x 4" x 15-1/2"	2-1/4" to 2-1/2"	1/2"	505	
1/2" x 4" x 15-1/2"	2-1/4" to 2-1/2"	1/2"	P57-0370	
1/2" x 4" x 21" - RH	2-1/4" to 2-1/2"	1/2"	P57-0270	
1/2" x 4" x 21" - LH	2-1/4" to 2-1/2"	1/2"	P57-0271	
5/16" x 1-1/2" x 10-1/2"	1-1/4" to 2-1/4"	7/16"	P57-0200	
5/16" x 2" x 9-1/2"	1-3/4"	7/16"	P57-0072	
5/16" x 2" x 10-1/2"	1-1/4" to 2-1/4"	7/16"	P57-0202	
5/16" x 2-1/2" x 10-1/2"	1-1/4" to 2-1/4"	7/16"	P57-0204	
3/8" x 2" x 11"	1-1/4" to 2"	3/8"	ST20	
3/8" x 2" x 11"	1-1/4" to 2"	7/16"	ST21	
3/4" x 2" x 17"	2-1/4"	7/16"	47022	
5/16" x 4" x 14-1/2"	2-1/4" to 2-1/2"	1/2"	P57-0350	
5/8" x 2" x 17"	2-1/4"	7/16"	45022	
5/8" x 2" x 17"	2-1/4"	7/16"	45022H	
5/8" x 2" x 17"	2-1/4"	1/2"	45522	
5/8" x 2" x 17"	2-1/4"	1/2"	45522H	
5/8" x 2" x 17"	2-1/4"	3/4"	47522	
5/8" x 2" x 17"	2-1/4"	3/4"	47522H	
5/8" x 2" x 15"	2-1/4" to 2-1/2"	1/2"	P57-0230	
5/8" x 2" x 15"	2-1/4" to 2-1/2"	7/16"	P57-0235	
1" x 2" x 18"	2-1/4" to 2-1/2"	1/2"	P57-0260	
1" x 2" x 18"	2-1/2"	1/2"	P57-0265	

3-PIECE SOIL SAVER

Uses 1/2" Clipped head bolt. ADI stands for Austempered Ductile Iron. Used with SOS05 & SOS06.

Fits Brillion, Bush Hog, Duetz-Allis, Glencoe, Kelly, Kent, Krause, Landoll, MF, Sunflower, Etc.

Description	Order No.	Price
Plain, Right. 4-1/8" w x 3/8" Thick	SOS03	
Hard-Faced, Right. 4-1/8" w x 3/8" Thick	SOS03H	
Plain, Left. 4-1/8" w x 3/8" Thick	SOS04	
Hard-Faced, Left. 4-1/8" w x 3/8" Thick	SOS04H	
Left ADI Point	P57-0105	
Right ADI Point	P57-0106	
Clipped Head Bolts	B55-0530	
Hex Head Bolts	B55-0540	

MOLDBOARDS FOR 3-PIECE TWISTED CHISEL

Use with 3-Point Soil Savers listed above. 3/8" X 4" X 18". Bolt size is 1/2" x 3".

Description	Order No.	Price
Plain, Right	SOS05	
Plain, Left	SOS06	



CRESCENT HOES

1/4" Thick. 3/8" Bolt size. 1-1/4" to 1-3/4" hole spacing.



Size	Description	Order No	Price
6"	Plain, Left	CH06L	
6"	Plain, Right	CH06R	

TENDER PLANT HOES

3/16" Thick. 3/8" Bolt size. 1-1/4" to 1-3/4" hole spacing.



Size	Description	Order No	Price
7"	Plain, Left	TP07L	
7"	Plain, Right	TP07R	
9"	Plain, Left	TP09L	
9"	Plain, Right	TP09R	

CHISEL POINTS

200 SERIES

Reversible, No twist. 1-Piece. 2" Wide. 15" Long. 2-1/4" hole spacing. Made of high carbon steel. Heat-treated.

Thickness	Bolt Size	Description	Order No	Price
1/2"	7/16"	Plain	20022	
5/8"	7/16"	Plain	25022	
5/8"	7/16"	Hardfaced	25022H	
5/8"	1/2"	Plain	25522*	
5/8"	1/2"	Hardfaced	25522H	
3/4"	1/2"	Plain	27522	



CHISEL POINTS - REVERSIBLE, TWISTED. 1-PIECE

1/2" Thick. 3" Wide. 22" Long. Fits all high clearance chisel plows. 1/2" Holes.



Width	Description	Bolt Size	Hole Spacing	Order No	Price
3"	Plain, Left	7/16"	2-1/4"	TC12L	
3"	Plain, Right	7/16"	2-1/4"	TC12R	
3"	Plain, Left	1/2"	2-1/4" to 2-1/2"	TC125L	
3"	Plain, Left	1/2"	2-1/4" to 2-1/2"	TC125LH	
3"	Plain, Right	1/2"	2-1/4" to 2-1/2"	TC125R	
3"	Plain, Right	1/2"	2-1/4" to 2-1/2"	TC125RH	
4"	Plain, Left	1/2"	2-1/4" to 2-1/2"	P57-0271*	
4"	Plain, Right	1/2"	2-1/4" to 2-1/2"	P57-0270*	

*21" Long. 4" Wide

CHISEL POINTS REVERSIBLE - 1 PIECE

2" Wide. 1/2" Bolt size. 2-1/4" to 2-1/2" hole spacing.



Thickness	Length	Hole Replaces	Description	Order No	Price
5/8"	15"	HE182-9C	Plain	P57-0221	
5/8"	15"	HE182-9CHF	Hard-Faced	P57-0225	
1"	18"	HD88	Plain	P57-0260	

SLASH POINTS - TWISTED CHISEL - 1 PIECE

One piece chisel will replace the complete three piece moldboard assemblies on chisel plows. 2-1/4" Hole spacing. .4" bolt size.



Fits Brillion, Bush Hog, Duetz-Allis, Glencoe, Kelly, Kent, Krause, Landoll, MF, Sunflower, Etc.

Description	Size	Order No.	Price
Plain, Right	1/2" x 4" x 24"	SOS01	
Hard-Faced, Right	1/2" x 4" x 24"	SOS01H	
Plain, Left	1/2" x 4" x 24"	SOS02	
Hard-Faced, Left	1/2" x 4" x 24"	SOS02H	
Plain, Right	1/2" x 3" x 24"	SOS13R	
Hard-Faced, Right	1/2" x 3" x 24"	SOS13RH	
Plain, Left	1/2" x 3" x 24"	SOS23L	
Hard-Faced, Left	1/2" x 3" x 24"	SOS23LH	

CONSERVATION RIPPER POINTS

Uses solid 25% chrome carbide in all wear surfaces. Self scouring so they deflect soil flow away from the shank.



Size	Description	Application	Order No.	Price
10"		Mulch Ripper, Krause TL, 3000 Disc Ripper, Krause 4880 Disc Ripper, Dammer-Diker Subsoilers, P-K Rippers, Baker & Laney Rippers	SS21C	
7" 10"	Winged Point	Case IH/DMI Ecolo-Tiger 1-1/4" Shank Disc Rippers & Subsoilers Models 527, 530, 730, 9300 & MRX690, Krause Dominator 1-1/4" Shank	SS22C SS23C	
10"	Winged Point	Case IH/DMI Ecolo-Tiger 1-1/2" Shank Disc Rippers & Subsoilers Models 527, 530, 730, 9300. MRX690	SS25C	
7"	Winged Point	Sunflower 4110 and 4411 Disc Ripper, M&W Disc Rippers	SS26C	
10"	Winged Point	Brillion Subsoilers and Disc Rippers	SS31C	
1-1/4" x 22"	Shin Guard	BLU-JET Sub-Tiller	SS36C	



SUBSOILER/RIPPER POINTS



Size	Description	Cap	Bolt Size	Hole Spacing	Application	Order No.	Price
1-1/4" x 1-7/8" x 7-1/4"	Plain		Drive-on	N/A	Caterpillar, Scarifier, Big Ox	BIGOX	
1-1/4" x 1-7/8" x 7-1/4"	Capped	26CC	Drive-on	N/A	Caterpillar, Scarifier, Big Ox	BIGOXH	
Full Chromium Carbide	Cap w/Wrap-Around	Nose	Drive-on	N/A	Caterpillar, Scarifier, Big Ox	BIGOXH80	
1" x 2" x 12"	Plain		1/2"	3"	Case, JD A17994, 90V, 900V, Q30681, Kelly	SS02	
1" x 2" x 12"	Capped	12CC	1/2"	3"	Case, JD A17994, 90V, 900V, Q30681, Kelly	SS02H	
1" x 2-1/2" x 12"	Plain		5/8"	3" 2 Bolt Flange	Case, JD A17994, 90V, 900V, Q30681, Kelly	SS03	
1" x 2-1/2" x 12"	Capped	07CC	5/8"	3" 2 Bolt Flange	Case, JD A17994, 90V, 900V, Q30681, Kelly	SS03H	
3/4" x 2-1/4" x 12"	Plain		Booted	N/A	Case, JD A17994, 90V, 900V, Q30681, Kelly	SS04	
3/4" x 2-1/4" x 12"	Capped	08CC	Booted	N/A	AA31215	SS04H	
1" x 2-1/2" x 12"	Capped	95CC	Booted	N/A	AA31215 Winged	SS04HW	
3/4" x 2-1/4" x 12"	Double Capped	(2)8CC	Booted	N/A	AA21507	SS04HH	
1" x 2-1/2" x 12"	Plain, HD		Booted	N/A	John Deere	SS04HD	
1" x 2-1/2" x 12"	Capped, HD	07CC	Booted	N/A	John Deere	SS04HHD	
3/4" x 2" x 10-1/4"	Plain		Booted	N/A	Brillion IJ481	SS07	
3/4" x 2" x 10-1/4"	Capped	12CC	Booted	N/A	Brillion IJ481	SS07H	
1/2" x 1-3/4" x 6"	Plain		Booted	N/A	Hamby H30, Johnson, Howard	SS08	
1/2" x 1-3/4" x 6"	Capped	26CC	Booted	N/A	Hamby H30, Johnson, Howard	SS08H	
1" x 2" x 12"	Plain		Booted	3/8"x2" Roll Pin	Paulk	SS09	
1" x 2" x 12"	Capped	12CC	Booted	3/8"x2" Roll Pin	Paulk	SS09H	
1" x 2" x 8-1/2"	Plain		Booted	1/2"x2" Roll Pin	Forrest City	SS10	
1" x 2" x 8-1/2"	Capped	12CC	Booted	1/2"x2" Roll Pin	Forrest City	SS10H	
1" x 2" x 11"	Plain		Booted	3/8"x2" Roll Pin	New Kelly, KMC, 1" Shank	SS11	
1" x 2" x 11"	Capped	12CC	Booted	3/8"x2" Roll Pin	New Kelly, KMC, 1" Shank	SS11H	
3/4" x 2-1/2" x 12"	Plain		Form.Ear	1/2"x2-1/2"	M&W 60 & 65 Earthmaster Series	HA2438357	
3/4" x 2-1/2" x 12"	Hard-Faced		Form.Ear	Roll Pin Used	M&W 60 & 65 Earthmaster Series	HA2438357H	
1" x 2" x 11"	Plain		Booted	N/A	KMC 3/4" Shank	SS14	
1-1/2" x 10"	Chrome Cap		Booted	N/A	DML, Turbo Tiger®, Tiger Two®, Turbo Tiger II® Ecolo Tiger®	HA09907000	
6"	Covering Point For HA09907000				527, 527B, 530B, 530C, 730B, 730C, 6750, 9300, ST650, ST720, ST775	608C	
8"	Covering Point For HA09907000				530, 530B, 530C, 730, 730B, 730C, 9300, ST770, ST775	610C	

SUBSOILER CAPS - CHROMIUM CARBIDE



Size	Application	Order No	Price
2" x 4"	Fits 1-3/4" Wide	26CC	
2-1/4" x 4"	Fits 2" Wide	12CC	
2-1/2" x 4"	Fits 2-1/4" Wide	08CC	
2-3/4" x 4"	Fits 2-1/2" Wide	07CC	
3-3/16" x 4"	Fits 3" to 3-1/4" Wide	18CC	

ROTARY HOE WHEELS

• 5/8" ID Bearings

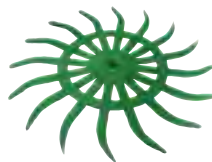

Replaces Number	Application	Order No.	Price
AN142664	J.D. Cult. 75.85 & RM, 400 series, 415, 430	W29-0303	
3400-111G	Yetter	W29-0301	
875-001-133	Hiniker		
27-1830114	M & W		
196-9217-C1	Case IH		
3400-111B	Yetter	B15-0200	
203KRR2	Bearing		

TILLAGE

HARROW TINES

Pictures are available on pages 434 - 438.

Replaces Number	Wire Gauge	Length A	Coil Width B	Coil Spacing C	Hole D	Application	Order No	Price
143101	.375"	16-1/2"	9"	5"	1.69"	Degleman	T30-0001	
1334	.375"	14-1/2"	7-1/4"	3-1/4"	1.75"	Flexi-coil	T30-0003	
4341	.375"	16"	6-1/2"	Narrow	1.84"	Flexi-coil	T30-0004	
P1546	.375"	11-5/16"	Single	Single	2.15"	Glencoe	T30-0006	
8H-1110	.375"	12-3/4"	7-5/8"	Narrow	2.10"	Herman	T30-0007	
H-1140	.375"	14-3/4"	5-3/4"	Narrow	2.10"	Herman	T30-0008	
149781	.375"	11-1/4"	7-1/2"	3-1/2"	1.81"	Inland, Noble	T30-0009	
N136767	.375"	13-1/2"	7-3/8"	3-1/8"	1.67"	John Deere, 1975-1981	T30-0010	
N181162	.375"	12-3/4"	7-7/16"	3-1/8"	1.75"	John Deere, 1982-1985	T30-0011	
1238	.375"	14"	2-5/8"	Single	2.25"	Kovar	T30-0012	
N135002	.375"	12"	7-7/16"	3"	1.75"	John Deere, Before 1974	T30-0014	
R-14-04710	.312"	10-3/4"	2-3/8"	Single	1.50"	Lindsay	T30-0015	
L-14-04728	.312"	10-3/4"	2-3/8"	Single	1.50"	Lindsay	T30-0016	
R-14-04752	.375"	11"	3-1/16"	Single	1.80"	Lindsay	T30-0017	
L-14-04760	.375"	11"	3-1/16"	Single	1.80"	Lindsay	T30-0018	
M1	.312"	11-1/2"	7-1/4"	3-1/2"	1.62"	Mattson	T30-0019	
6524795/ME1	.375"	12-3/8"	7-1/4"	3-1/8"	2.00"	Melroe	T30-0021	
CH-113A	.375"	12-3/4"	6-1/2"	3-1/4"	1.50"	Midwest	T30-0023	
H-1791	.375"	16-7/8"	9"	5"	1.69"	Morris	T30-0024	
H-4087	.375"	16-7/8"	9"	5"	1.69"	Morris	T30-0025	
13419	.375"	12"	9-3/8"	5"	1.73"	Wilrich	T30-0027	
16249, 16429	.375"	16"	9-3/8"	5"	1.63"	Wilrich	T30-0028	

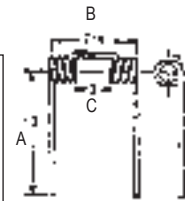

HARROW SHOES

Fits John Deere



Size	Replaces	Order No	Price
51-3/8"	LH896	S31-0110	

SHANK SAVERS - POLY

Size/ Application	Hole Spacing	Bolt Size	Box Qty.	Order No	Price
1-3/4" x 9" x 1/4"	1-5/8" to 2" Field Cultivators	3/8"-7/16"	100	P44-0360	
2" x 10" x 1/4"	2-1/4" to 2-1/2" Chisel Plows	7/16"-1/2"	100	P44-0361	
V-Blade Guard			Each	20010085	

BACK SWEEP, SIDE MOUNT KNIVES W/ADALLOY CHROMIUM CARBIDE INSERT

Made In The USA

Size	Hole	Bolt
Thickness/ W/ L	Spacing	Size
1/2" x 2" x 14-3/8"	1-1/2" to 3"	1/2"

AK42-1



Order Number	Description	Price
AK42-1	w/3/8" Gas Tube	

AK42 series knives are ideal for side dress, maximum till or no till applications. Back swept design penetrates better and seals well in all soil conditions.

FRONT SWEEP SIDE MOUNT KNIVES W/ADALLOY #62 CHROMIUM CARBIDE INSERT

Made In The USA

Size	Hole	Bolt
Thickness / W/ L	Spacing	Size
1/2" x 2" x 14	1-1/4" to 2-3/4"	1/2"

AK62-1



Order Number	Description	Price
AK62-0-3	Sealer Only	
AK62-1	With 3/8" Gas Tube	
AK62-1S	With 3/8" Gas Tube w/Sealer	

AK62 series knives have the Adalloy #62 insert which extends 6-1/2" up the front. It "shatters" hard soil and wears sharp. Adalloy tube protector extends 4-1/2" up the back.

CHISEL PLOW KNIVES WITH ADALLOY #62 CHROMIUM CARBIDE INSERT

Made In The USA

Size	Hole	Bolt
Thickness / W/ L	Spacing	Size
5/8" x 2" x 14"	2-1/4" - 2-1/2"	1/2"

AK72-1



Order Number	Description	Price
AK72-1	With 3/8" Gas Tube	
AK72-3	With 3/8" Liquid Tube	

Note: For 7/16" punched shanks, use "reducer head" plow bolts. AK72 series knives are one of the longest wearing chisel knives in the industry due to the super long wearing Adalloy insert which protects virtually the entire wear face. Also has Adalloy tube protector on the entire back edge of the knife.

GROUND HOG KNIVES - FRONT SWEEP SIDE MOUNT WITH ADALLOY CHROMIUM CARBIDE INSERT

Made In The USA

- 1-7/8" Wide Foot Piece
- 3/8" Tube w/63CC Tube Protector
- 33C Insert w/Sharp Leading Edge
- Wears Sharp and Stays Sharp
- Doesn't Wear Blunt & Pulls Easier
- Foot Piece and Insert Work Together to Create a Funnel or Expansion Chamber for the NH3.

Size	Hole	Bolt
Thickness / W/ L	Spacing	Size
1/2" x 2-1/2" x 15-1/8"	1-1/4" To 2-3/4"	1/2"

AK33-1



Order Number	Description	Price
AK33-1	w/3/8" Tube & Tube Protector	

FRONT SWEEP, SIDE MOUNT KNIVES W/ADALLOY #92 CHROMIUM CARBIDE INSERT

Made In The USA

Size	Hole	Bolt
Thickness / W/ L	Spacing	Size
1/2" x 2-1/2" x 15"	1-1/4" - 2-3/4"	1/2"

Order Number	Description	Price
AK92-1	With 3/8" Gas Tube	
AK92-1S	With 3/8" Gas Tube w/Sealer	
AK92-4	With 3/8" Gas & 3/8" Liquid Tubes	

AK92 series knives have the Adalloy #62 insert which extends 6-1/2" up the front. Dual tubes also available for liquid or gas.

FIELD CULTIVATOR KNIVES WITH ADALLOY CHROMIUM CARBIDE INSERT

Made In The USA

Size	Hole	Bolt
Thickness / W/ L	Spacing	Size
7/16" x 1-3/4" x 12-1/2"	1-3/4" - 1-7/8"	7/16"

AK82-1



Order Number	Description	Price
AK82-1	With 3/8" Gas Tube	
PT82-1	3/8" Gas Tube For AK-82 See 86524	

Note: For 3/8" Punched Shanks, Use "Reducer Head" Plow Bolts. AK 82 Series Knives Apply Nitrogen 3" to 4" Deeper Than Sweeps And Seal Well In All Soils. Adalloy Insert Extends Life 3 To 5 Times Over Hardfaced Knives.

ANHYDROUS FERTILIZER (NH3) TUBES & SEALERS

Made In The USA

Order Number	Description	Application	Price
63CC	Single tube protector	For All Knives	
AK62-0-3	Sealer	For All Knives	
83CC	Dual Tube protector	For Dual Tube Knives	

PT62-1



TILLAGE

UNIVERSAL DOUBLE DISC ASSEMBLIES

Hardware included. 2 per carton.

FLAT, 13-1/2" DIAMETER - "ADAMS" STYLE WITH TRASH SHIELD

For Crustbuster Red Box Drill, Crustbuster Silver Box Drill, Great Plains Drill, IHC Planter, JD Drill, JD 9300 Air Seeder w/cast shoes, Lilliston Drill, New Idea, Tye Drill, White 5100 Planter, Krause"

*Requires 1-3/4" Left Hand Bolt: 20010336

**Requires 2 Dust Caps: 20010391

Order No.	Price
20010548	/box of 2
20010548A	/Single No Hardware

FLAT, 13-1/2" DIAMETER - "HERSCHEL" STYLE WITH DUST CAP

For Allis Chalmers Planter - Fertilizer, Case-IH Planter - Fertilizer & Seed, Crustbuster Red Box Drill, Crustbuster Silver Box Drill, Great Plains Drill, John Deere Drill, John Deere 7000, 7100 Planter-Fertilizer", John Deere 7200, 7300 Planter-Fertilizer", Lilliston, (Melroe) Drill, Morris Drill, Tye Drill, White 3400 & 5100 Planter - Fertilizer & Seed

Order No.	Price
B45-3194	/box of 2
B45-3194A	/Single No Hardware



FLAT, 15" DIAMETER - "ADAMS" STYLE WITH TRASH SHIELD

For Great Plains, White 6000, John Deere 7000, 7100, 7200, 7300, 1700 Max Emerge 2 & Max Emerge Plus Planters - Seed, Kinzie Planter - Seed, New Idea Planter - Seed

Order No.	Price
20010575	/box of 2
20010575A	/Single No Hardware

FLAT, 15" DIAMETER - "HERSCHEL" STYLE WITH DUST CAP

For Great Plains, White 6000, John Deere 7000, 7100, 7200, 7300, 1700 Max Emerge 2 & Max Emerge Plus Planters - Seed, John Deere 7200, 7300 Planter - Seed, Kinzie Planter - Seed, New Idea Planter - Seed

Order No.	Price
B45-3195	/box of 2
B45-3195A	/Single No Hardware

JOHN DEERE AND KINZIE PLANTER SEED DISC OPENERS

Made In The USA. High Quality Boron Steel. Includes Hub & Bearing, Order Dust Cap Separately(Listed Below)

Heavy Duty Seed Opener Assembly. 3.5MM thick, 15" Diameter

Application	Replaces	Order No	Price
John Deere 7000, 7100 Max Emerge, 7200, 7330, and 1700 Series Planters. Kinzie Planters except 3000 series.	AA53860 GA8324	HAA53860	
John Deere 7000, 7100 Max Emerge, 7200, 7330, and 1700 Series Planters. Kinzie Planters except 3000 series. Double row bearing.	AA65248	HAA65248	



HAA53860

Standard Seed Opener Assembly. 3MM thick, 15" Diameter

Application	Replaces	Order No	Price
John Deere 7000, 7100 Max Emerge, 7200, 7330, and 1700 Series Planters. Kinzie Planters except 3000 series.	AA55927 GA2013	HAA55927	

Description	Order No	Price
Plastic Dust Cap For Above	0475-02935	
Metal Dust Cap For Above	0475-02960	

FERTILIZER DISC OPENERS

Fits JD 7000, 7100, 7200, 7300. Dust cap required pn 0475-02935*
*Herschel assembled in the USA.

MADE IN THE USA! Made From High Quality Boron Steel. Includes hub & bearing.

13.5" x 2.54mm Assembly

Order No	Price
HAA57466	

UNIVERSAL COVERING CHAIN

Heavy Gauge Steel Welded 3-Ring Construction



Order No	Price
C30-0050	

TILLAGE

NON-CAST DRILL POINTS

Heat-treated. Made from 1080 High Carbon Steel.

Made In The USA



Description	Application	Order No.	Price
Plain, 1/4" x 2"	John Deere	JD02	
Plain, 5/16" x 1-3/4" x 11", Bolt Size 3/8"	Crustbuster	CC06	

CAST DRILL POINTS - A SERIES

Adalloy Chromium Carbide Point. Improved Ground Penetration.

Made In The USA



Application	Bolt Size	Order No.	Price
IHC Eagle Beak 7400, 8500 etc. Bolts, Roll Pins & Nut included.	1/4" x 1-1/4"	11CC	
John Deere Only. 9300 or Earlier	1/4" Flat	73CC	
John Deere 9400 JD.	Roll Pin	75CC	
John Deere, Crustbuster, AcraPlant, Great Plains, Mighty Handy		98CC	
John Deere, Crustbuster, AcraPlant, Great Plains, Mighty Handy, w/V Groove		99CC	

13-1/2" FLAT OEM STYLE DOUBLE DISC ASSEMBLIES

Application	Disc Assembly w/Hardware (2/ Carton) Price	Blade Only Each Price	Bearing Each Price	Trash Shield or Dust Cap Each Price	Seal (10/Bag) Price	Seal Mtg. Spacer (10/Bag) Price	Washer/ Spacer (10/Bag) Price
John Deere*	B45-3200	B45-3202	0475-02760	Not Req.	S16-0240	Not Req.	20010655
Great Plains***	B45-3090	B45-3048	0475-02513	Use OEM	Not Req.	Not Req.	Not Req.
IHC**	B45-3089	B45-3047	0475-02231	0475-02565	S16-0232	S16-0233	Not Req.
Marliss***	20010552	DD135FDD**	GP205	20010536	Not Req.	Not Req.	

* Fits: B, B-A, B-B, B-C, D-C, DF-B, DF-C, DR-A, DR-B, FB-B, FB-C, LL-A, LL147, LL166, PD-A, 450, 515, 520, 770, 780, 8100, 8200, 8250, 8300, 8500, 8550, 9300, 9350, 9400, 9450. **Will not work on Marliss drills with bolt-on hubs. ***Note: On IHC applications, the diameter of the disc assembly is 13-7/8". Fits 510, 5100, 620, 6200, 5200 *** Fits: All Models

13" CONCAVE OEM STYLE SINGLE DISC ASSEMBLIES

Application	Disc Assembly w/Hardware (2/ Carton) Price	Blade Only Each Price	Bearing Each Price	Trash Shield or Dust Cap Each Price	Seal (10/Bag) Price
John Deere (Internal 1/2" threads). Fits: B, B-A, B-B, B-C, D-C, DF-B, DF-C, DR-A, DR-B, FB-B, FB-C, LL-A, LL147, LL160, LZ-B, PD-A, 8100, 8200, 8250, 8300, 8350. Replaces AM12419 & AN161227	B45-3410	B45-3046	0475-02237	Not Req.	S16-0240
John Deere, New Style. (External 5/8" threads) Fits: 450, 515, 8100, 8200, 8250, 8300, 8350, 8500, 8550	B45-3084	B45-3046	0475-02237	Not Req.	S16-0240
Massey/Oliver			0475-02933	20010392	S16-0240

14" CONCAVE OEM STYLE SINGLE DISC ASSEMBLIES

Application	Disc Assembly w/Hardware (2/ Carton) Price	Blade Only Each Price	Bearing Each Price	Trash Shield or Dust Cap Each Price	Seal (10/Bag) Price	Seal Mtg. Spacer (10/Bag) Price
Crustbuster	20010563	DD14CSD	0475-02237	Not Req.	S16-0240	
IHC	B45-3408*	B45-3045	0475-02231	Not Req.	S16-0232	S16-0233
IHC, (Heavy Duty)	20010562*		0475-02933	Not Req.	S16-0240	
John Deere, Old Style (Internal 1/2" Threads) Fits: B-A, B-B, B-C, D-C, DF-8, DF-C, DR-A, DR-B, FB-B, FB-C, 8100, 8200, 8250, 8300, 8350. AN161227.	B45-3409	B45-3045	0475-02237	Not Req.	S16-0240	
John Deere, New Style (External 5/8" Threads) Fits: 450, 515, 8100, 8200, 8250, 8300, 8350, 8500, 8550	B45-3902	B45-3045	0475-02237	Not Req.	S16-0240	

DRILL DISC BLADES

Description	Replaces Number	Application	Disc Assembly Used In	Thick-ness	Center Hole	Bolt Hole	Bolt Circle	Order No.	Price
14" Concave	PD1413	JD, IHC	B45-3408 B45-3409 B45-3902	.094	1.280	(6).265	2.500	B45-3045	
13" Concave	PD1313	JD	B45-3410 B45-3084	.094	1.280	(6).265	2.500	B45-3046	
13-7/8" Flat	603013R2	IHC	B45-3089	.080	1.370	(6).265	2.500	B45-3047	
13-1/2" Flat	820-002C	Great Plains	B45-3090	.100	1.580	(6).224	2.750	B45-3048	
13-1/2" Flat	DO 1350	Universal	B45-3194	.100	1.250	(6).265	2.750	B45-3136	
15" Flat	DO 1500	Universal, Kinze, NI, JD	B45-3195	.120	1.250	(6).265	2.750	B45-3151	
13-1/2" Flat	K202M	John Deere	B45-3200	.089	1.171	(6).265	2.500	B45-3202	
13-1/2" Flat		Universal	20010548	.118	1.562	(6).265	2.875	DD135FDD	
14" Concave		IHC, Crustbuster	20010563 20010562	.118	1.562	(6).265	2.875	DD14CSD	
15" Flat		JD, Kinze, NI Planter	20010575	.118	1.562	(6).265	2.875	JDA22991	
18" Flat	N283804	JD 750, 1850, 1560, 1860 No Till Grain Drills		.203	3.031	(4).406	4.375	B45-3049	
13-1/2" Raised Center	N164594			.100	.472			B45-3500	



TILLAGE

DRILL DISC BEARINGS

Replaces Number	Bore Size	Application	Order No.	Price
465004R91	.667	IHC, B45-3089, B45-3408	0475-02231	
Z9504AB	.750	JD, B45-3409, B45-3410, B45-3084, B45-3902	0475-02237	
204RR8	.627	Great Plains B45-3090	0475-02513	
RA012, 204RY2, 204PY2	.631	Universal, B45-3194, B45-3195	0475-02933	
	.750	Marliss Double Discs	GP205	
	.629	Universal Double Discs, 13-1/2" & 15", 20010548, 2000575	GP205DDS	
203KRR2	.635	JD B45-3500	B15-0200	
N/A		JD 150, 1850, 1560, 1860. Includes: 2 Cones, 2 Cups, 2 Seals, 2 Retainers, 1 O-Ring	B15-0750	



SEED BOOTS

Fits JD 750 Grain Drill & 1850 Air Seeder

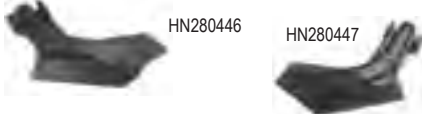

OEM No	Description	Order No	Price
N280446	Right Hand	HN280446	
N280447	Left Hand	HN280447	

NEOPRENE SEED AND FERTILIZER TUBES

Lower Diameter : 1-1/4"



Working Length	Upper Diameter	Application	Order No.	Price
20"	1-9/16"	Case Grain Drills	T82-0014	
17"	1-9/16"	JD Grain Drills	T82-0016	
15"-36"	2-1/4"	Oliver #25 Grain Drill & #402 Planter w/Eyelet	T82-0018	

DUST CAPS AND TRASH SHIELDS

Package Qty: Each



Description	Application	Order No	Price
Dust Cap, Plastic	Univ. B45-3194, B45-3195	0475-02935	
Dust Cap, Metal	Univ. B45-3194, B45-3195	0475-02960	
Dust Cap	IHC B45-3089	0475-02565	
Dust Cap	15" Univ. 20010575 & 13-1/2" Krause 20010548	20010391	
Dust Cap	MF 20010565	20010392	
Trash Shield	13-1/2" Univ. 20010548	20010491	
Trash Shield	Marliss 20010552	20010536	

SEAL MOUNTING SPACERS

Bag Qty: 10



Replaces Number	Description	Application	Order No	Price
602988R1	Seal Seat	IHC B45-3089, B45-3408	S16-0233	

HARDWARE

20010395



Size	Description	Application	Pkg Qty	Order No	Price
1/4" x 1/2"	Rivet	Universal	1 LB.	R36-0002	
1/4" x 5/8"	Rivet - Zinc Plated	Universal	1 LB.	R36-0480D	
5/8" x 1-3/8"	Bolt Only, RH & LH	Universal Herschel Style	2/Bag	B55-0693	
5/8" x 1-1/4" RH	Bolt Only	Various	Each	00752658	
5/8" x 1-1/2" RH	Bolt Only	Universal Adams Style	Each	02675800	
5/8" x 1-1/2" LH	Bolt Only	Universal Adams Style	Each	20010335	
5/8" x 1-3/4" LH	Bolt Only	Crustbuster, Silverbox	Each	20010336	

JOHN DEERE GRAIN DRILL REPLACEMENT PARTS

Fits 750 Grain Drills & 1850 Air Seeders

OEM Number	Description	Order No.	Price
AN211864	Gauge Wheel Assembly	HAN211864	
AN212132	Gauge Bearing	HAN212132	
AA38447	Closing Wheel Assembly	HAA38447	
AN281357	Heavy Closing Bearing	HAN281357	
N280447	SEed Boot LH	HN280447	
AN213544	Seeder Blade Hub	HAN213544	
N/A	Disc Bearing Kit	B15-0750	
N214190	18" Blade	B45-3049	



A

A-Frame Jacks 177
 Adapters & Couplers..... 189 - 191
 Additives..... 182

B

Bale Spears 187
 Battery Cables & Accessories 171
 Bearing Packer 180
 Bearings and Flanges..... 196 - 197
 Bulldog Jacks 177

C

Cab Heater 184
 Canopies 169
 Chain, Roller..... 194
 Chain, Tractor Tire..... 184
 Chain, Steel Link 194
 Clevis..... 185
 Couplers, Hydraulic..... 189
 Cylinders..... 188

D

Depth Control Collars 188
 Drawbars & Drawbar Parts 186
 Drawpins..... 187
 Drivelines..... 192 - 193

E

Engine Heaters..... 175
 Exhaust Caps 178
 Exhaust Pipes & Extenders 178

F

Flashers..... 175
 Flanges, Bearing 197
 Freeze Plug Heaters..... 175
 Funnels..... 180

G

Grease Fittings 179
 Grease Fitting Repair Tool 180
 Grease Guns 179
 Ground Straps 171

H

Hair Pins & Hitch Pins 185
 Headlamps 172
 Heaters, Engine..... 175
 Hi Lift Jack..... 177
 Hoses & Cylinders..... 188, 189
 Hydraulic Adapters 189 - 191
 Hydraulic Couplers 189

H Continued

Hydraulic Cylinders..... 188
 Hydraulic Gauge..... 188
 Hydraulic Hoses 188, 189
 Hydraulic Motors..... 191
 Hydraulic Pumps 190

I

Implement Jacks 177

J

Jacks 177

L

Lawn Tractor Seats..... 169
 Lift Arms and Parts..... 186
 Lights, Universal 172 - 174
 Love Joy Type Couplers..... 191
 Lubricants 183
 Lynch Pins..... 185

M

Manure Spreader Chain 199
 Mirrors 176
 Muffler Clamps 178

O

Oil Cans..... 180

P

Paint 166 - 167
 Paint Hardener 167
 Pillow Blocks..... 197
 Pioneer Couplers..... 189
 Pulleys 195
 Pumps and Motors..... 190

Q

Quick Hitch Specifications 186

R

Radiator Hose..... 178
 Radiator Hose Heaters 175
 Radios 170
 Rain Caps..... 178
 Reflective Tape..... 175
 Roller Chain..... 194

S

Safety Lights 175
 Safety Pins 185
 Seal Puller 180

S Continued

Sealants..... 181
 Seats 168, 169
 Shop Towels..... 183
 Slow Moving Vehicle Emblem 175
 Spot Sprayers..... 198
 Sprayers 198
 Sprayer Parts..... 198
 Spreader Chains..... 199
 Sprockets & Hubs..... 195
 Stabilizer Kits..... 186
 Switches, Universal 171

T

T-Bar Chain 194
 Tank Heaters 175
 Three Point Parts..... 186 - 187
 Tire Chains, Tractor..... 184
 Tool Boxes, Universal..... 176
 Top Links and Parts 186, 187
 Tube Mount Jacks 177
 Turnbuckle Jack 185

U

Umbrellas 169

W

Weld-On Jacks 177

Lead Free Enamel. Tractor & Implement paint is for machinery only. Not intended for use on toys, fence gates, or other objects. Paints must be shipped via UPS Ground ONLY. *Oil Based*



HOW TO PAINT A TRACTOR DVD



This video demonstrates the entire painting process including sanding, priming, body work, painting and decals. 56 minutes.

Order No. 400049

Sandable Gray Primer

High quality sandable acrylic primer can be used with a wide range of topcoats. Fast filling and low shrinking. Easy wet or dry sanding. 10-15 min dry to touch, 1 hour to sand/topcoat. Excellent adhesion and holdout. Superior resistance to rust and corrosion. Covers approximately 300 sq ft per gallon.



Fast Drying!

Aerosol Order No. A 972608
 Quart Order No. A 962608
 Gallon Order No. A 952608

Description/Size Order No. Price

ALLIS CHALMERS PERSIAN ORANGE

Gallon A 951001
 Quart A 961001
 12 oz. Aerosol A 971001

ALLIS CHALMERS PERSIAN II

(1961 & Later)

Gallon A 951002
 Quart A 961002
 12 oz. Aerosol A 971002

ALLIS CHALMERS CREAM

Quart A 961003
 Aerosol A 971003

ALLIS CHALMERS CORP. ORANGE

Gallon A 951004
 Quart A 961004
 12 oz. Aerosol A 971004

ALUMINUM

Gallon A 952503
 Quart A 962503
 12 oz. Aerosol A 972503

Aluminum, High Temp

12 oz. Aerosol A 972507

BLACK

Black Gloss

Gallon A 952501
 Quart A 962501
 12 oz. Aerosol A 972501

Black, High Temp.-Flat

12 oz. Aerosol A 972506

CASE FLAMBEAU RED

Gallon A 951501
 Quart A 961501
 12 oz. Aerosol A 971501

CASE DESERT SAND

Gallon A 951502
 Quart A 961502
 12 oz. Aerosol A 971502

CASE POWER WHITE

12 oz. Aerosol A 971503

Description/Size Order No. Price

CATERPILLAR YELLOW (1980 To Present)

Gallon A 951101
 Quart A 961101
 12 oz. Aerosol A 971101

COCKSHUTT YELLOW

Quart A 961201
 12 oz. Aerosol A 971201

COCKSHUTT RED

Quart A 961202
 12 oz. Aerosol A 971202

FORD BLUE

Gallon A 951306
 Quart A 961306
 12 oz. Aerosol A 971306

FORD GRAY (8N, NAA, 600, 700, 800, 900 Series)

Gallon A 951304
 Quart A 961304
 12 oz. Aerosol A 971304

FORD LIGHT GRAY (2000 - 4000)

Gallon A 951305
 Quart A 961305
 12 oz. Aerosol A 971305

FORD DARK GRAY (9N, 2N)

Gallon A 951303
 Quart A 961303
 12 oz. Aerosol A 971303

FORD RED (Orange) 2000 - 4000

Gallon A 951302
 Quart A 961302
 12 oz. Aerosol A 971302

FORD RED (8N, NAA)

Gallon A 951301
 Quart A 961301
 12 oz. Aerosol A 971301

FORD WHITE

Quart A 961307
 12 oz. Aerosol A 971307

Description/Size Order No. Price

FARMALL GRAY

12 oz. Aerosol A 971401

FARMALL RED (Prior To 1981)

Gallon A 951402
 Quart A 961402
 12 oz. Aerosol A 971402

IH/FARMALL 1939-1947 EQUIPMENT BLUE

Quart A 961405
 12 oz. Aerosol A 971405

INTERNATIONAL HARVESTER (1981 - Current)

Gallon A 951403
 Quart A 961403
 12 oz. Aerosol A 971403

IH HARVESTER WHITE

Quart A 961404
 12 oz. Aerosol A 971404

J.D. 2-CYL. CLASSIC GREEN

Gallon A 951701
 Quart A 961701
 12 oz. Aerosol A 971701

JOHN DEERE GREEN (Ag Green)

Gallon A 951702
 Quart A 961702
 12 oz. Aerosol A 971702

JOHN DEERE YELLOW (Ag Yellow)

Gallon A 951703
 Quart A 961703
 12 oz. Aerosol A 971703

J.D. INDUSTRIAL YELLOW

Gallon A 951704
 12 oz. Aerosol A 971704

KUBOTA BLUE

Quart A 961902
 12 oz. Aerosol A 971902

KUBOTA ORANGE (1990 & Newer)

Gallon A 951901
 Quart A 961901
 12 oz. Aerosol A 971901

Description/Size	Order No.	Price
FERGUSON GRAY		
Gallon	A 952001	
Quart	A 962001	
12 oz. Aerosol	A 972001	
MASSEY FERGUSON LIGHT GRAY		
Gallon	A 952004	
Quart	A 962004	
12 oz. Aerosol	A 972004	
MF METALLIC FLINT GRAY		
Gallon	A 952003	
Quart	A 962003	
12 oz. Aerosol	A 972003	
MASSEY FERGUSON RED		
Gallon	A 952002	
Quart	A 962002	
12 oz. Aerosol	A 972002	
MASSEY HARRIS RED		
Gallon	A 952005	
Quart	A 962005	
12 oz. Aerosol	A 972005	
MASSEY HARRIS STRAW YELLOW		
Quart	A 962006	
12 oz. Aerosol	A 972006	
McCORMICK-DEERING RED		
Gallon	A 952102	
12 oz. Aerosol	A 972102	
MINN-MOLINE PRAIRIE GOLD		
Gallon	A 952201	
Quart	A 962201	
12 oz. Aerosol	A 972201	
MINNEAPOLIS-MOLINE RED		
Quart	A 962202	
12 oz. Aerosol	A 972202	
NEW HOLLAND RED		
Gallon	A 952302	
12 oz. Aerosol	A 972302	

Description/Size	Order No.	Price
NEW HOLLAND YELLOW		
Gallon	A 952301	
Quart	A 962301	
12 oz. Aerosol	A 972301	
OLIVER GREEN (Early) 1938-44		
Gallon	A 952402	
Quart	A 962402	
12 oz. Aerosol	A 972402	
OLIVER MEADOW GREEN - 1952 & Later		
Gallon	A 952403	
Quart	A 962403	
12 oz. Aerosol	A 972403	
OLIVER WHITE - Clover White		
Quart	A 962401	
12 oz. Aerosol	A 972401	
OLIVER RED		
Quart	A 962404	
12 oz. Aerosol	A 972404	
OLIVER YELLOW		
Quart	A 962405	
12 oz. Aerosol	A 972405	
WHITE GLOSS		
Gallon	A 952502	
Quart	A 962502	
12 oz. Aerosol	A 972502	
HIGH TEMPERATURE PAINT		
12 oz. Aerosol		
Black	A 972506	
Aluminum	A 972507	
PRIMERS		
RED OXIDE PRIMER		
Gallon	A 952504	
Quart	A 962504	
12 oz. Aerosol	A 972504	
GRAY PRIMER		
Gallon	A 952505	
Quart	A 962505	
12 oz. Aerosol	A 972505	



ACRYLIC HARDENER

Can be used as additive to improve the hardness of the paint film. In most cases, an increase in chemical resistance and improvement of gloss will occur. Provides chip resistant high gloss finish. 1/2 pint. Mix ratio: 1/2 pint to 1 gallon of paint.

Order No. _____ Price
A 972508

PROPANE TANK PAINT



Oil based formula with "Fortified" Ultra Violet Arrestores for longer lasting gloss white finish. Superior gloss retention and weather protection for the most severe conditions. Rust resistant enamel designed for use on propane tanks. Brush, roller or spray application.

Order No. _____ Price
A 941021



ACRYLIC LACQUER CLEAR COAT

Use for a "Water Clear" non-yellowing gloss coat on tractors and equipment. Spray application recommended. Provides additional protection and fade resistance.

Use over properly cured tractor, equipment and industrial enamel.

Aerosol Order No. A 972609
Quart Order No. A 962609
Gallon Order No. A 952609



Your Choice
\$

STANDARD PAN SEAT CUSHIONS

- 10 oz. laminated vinyl
- 1" poly foam
- 2 grommets for drain holes

Your Choice
\$

DELUXE PAN SEAT CUSHIONS

- 32 oz. waterproof vinyl
- 1" heavy-duty auto foam
- Canvas wrap end
- Nylon cord drawstring

Color	Application	Standard Order No.	Deluxe Order No.
White/Orange	21" Allis Chalmers	A 491650	A 490652
White/Blue	19" Ford		A 490750
Red/White	19" Ford	A 491651	A 490751
White/Blue	21" Ford	A 491652	A 490659
Red/White	21" Ford	A 491653	A 490651
White/Black	21" International		A 490653
White/Red	21" International		A 490650
Silver	21" International		A 490661
Yellow	19" John Deere	A 491655	A 490752
Black	19" John Deere		A 491900
Yellow	21" John Deere	A 491656	A 490655
Black	21" John Deere		A 490657
White/Green	21" Oliver		A 490654
White	21" Oliver		A 490660

PAN SEATS



IMITATION LEATHER PAN SEAT
Rigid seat. Rounded back for comfort. With drain holes. Black.

Order No. Price
A 913680



LARGE STEEL BUCKET SEAT
Mounts with one bolt. Will fit almost all springs. Reinforced center for longer wear. Red.

Order No. Price
A 1221027

TRACTOR SEATS



UNIVERSAL SEAT

- Black bucket seat with brackets.
- Fits Kubota, Ford, Massey-Ferguson and John Deere with flip-type seats.
- 16" wide x 13" deep x 13" tall.
- Black vinyl.

Order No. Price
A 913683

GRIZZLY STYLE SEAT

FOLDING BACK & ARM RESTS!



- 3" Fore/Aft Adjustment
- Molded Leatherette Upholstery
- Adjustable Mounting Brackets
- Multiple Hole Mounting Pattern

Type/Color Order No. Price
Black 1826042
Yellow 1826044

STANDARD GRAMMER SEAT

- Slide Track/Adjustable Base
- Fully Adjustable Suspension
- Suspension adjustment for weight from 132 - 265 lbs.
- Suspension includes hydraulic shock absorber.
- Suspension vertical travel is 4-3/4".
- Horizontal slide travel is 8-3/4".



Color Order No.
Black 1-826035
Blue 1-826036
Yellow 1-826037
Red 1826040
Cloth 1826041

Your Choice
\$

UTILITY TRACTOR SEATS



ADJUSTABLE SEAT

- Slide track base
- Fully adjustable suspension
- Adjustable angle base.
- Trapezoid back.

Color Order No. Price
Black 915991
Blue 915992
Yellow 915993
Black 915994*

*Fold-up armrests

915994



ADJUSTABLE SEAT WITH FLIP-OVER DESIGN

- Slide track base
- Fully adjustable suspension

Color Order No. Price
Black 915996

FORKLIFT SEATS



SLIDE-TRACK FORKLIFT SEAT

- Slide track base. Trapezoid back.
- Fits most forklifts.

Order No. Price
915999

915999



UNIVERSAL FORKLIFT SEAT
19"H x 18"W x 21"D. Steel core. Includes slides. Universal bolt patterns: 6"x5", 7.5"x7", 7.5"x11.5", 8"x11.5", 9"x9.63", 9.5"x11.5", 11.25"x11.5

Order No. Price
A 915998

915998

LAWN TRACTOR SEATS



- Steel pan with trimmed edge
- Blue vinyl covered molded cushions
- Drain hole and contoured for air flow
- Safety switch cavity
- Bolt patterns: 7.5"x1.625", 7.5"x3", 7.5"x7", 8.25"x5", 11.25"x11"
- Fits Lawn & Garden, Utility, and Compact Tractors

Color Order No. Price
Black 913903
Yellow 913905
Blue 913907

LAWN TRACTOR SEATS



UNIVERSAL LAWN TRACTOR SEATS
Integral polyurethane upholstery. Waterproof. Drain hole. Universal mounting. Bolt patterns 5.25" x 4.5", 6" x 5", 7.5" x 7". 1/2" center mount.

Style	Order No.	Price
High Back	A 913681	
Low Back	A 913682	



DELUXE HIGH-BACK SEAT

Steel pan with trimmed edge. Vinyl covered molded cushion. Drain hole and contoured for air flow. Bolt patterns: 7.5" x 1.625"; 7.5" x 3"; 7.5" x 7"; 8.25" x 5"; 11.25" x 11"

Color	Order No.	Price
Black	913903	
Yellow	913905	
Blue	913907	
Ford/New Holland Bracket Kit	913910	



UNIVERSAL LAWN TRACTOR SEATS

Single-center bolt pattern & 4-bolt pattern sizes are 5.25" x 4.5", 6" x 5", 7.5" x 7". Black vinyl all weather seamless molded cushion with protective edge trim. Outside Dimensions: 8.88" H X 15.63" D X 19" W

Bolt Pattern	Order No.	Price
5.25" x 4.5", 6" x 5", 7.5" x 7"	A 340125	
8" x 11.5", 11-1/4" x 11-1/2"	A 757112	

CANOPIES



40" CANOPY

Description	Order No.	Price
3-Bow Frame	A 405272	
Red Canvas	A 405580	
Yellow Canvas	A 405582	

48" CANOPY

Description	Order No.	Price
3-Bow Frame	A 405273	
Red Canvas	A 405590	
Yellow Canvas	A 405592	

MOUNTING BRACKETS

Description	Order No.	Price
Axle Mount Bracket	A 405241	
Fender Mount Bracket	A 405344	

UMBRELLA ASSEMBLIES & COVERS



ROPS MOUNTED UMBRELLA

- Fits ROPS bars from 2" x 2" to 3" x 3"
- Yellow dichromate zinc plated tubular steel frame
- Squeeze and release spring clips on umbrella bows
- Lock pin umbrella connection
- Pre-assembled components

Description	Order No.	Price
Assembly Only		
Order Covers at right	A 669121	



STANDARD UMBRELLA ASSEMBLY

- Preassembled components are designed for fast, easy installation and removal
- Yellow dichromate zinc plated tubular steel frame
- Four oil-tempered steel bows form a rigid frame work that withstands hard field use and strong winds

COVERS SOLD SEPARATELY AT RIGHT.

Order No.	Price
A 669120	

Your Choice



REPLACEMENT COVERS

For 54" umbrellas. Made of water resistant 10 oz. canvas duck cover with reinforced vinyl.

COLOR	ROPS MOUNTED	STANDARD
Red	A 674102	A 671105
Yellow	A 674103	A 671102
White	A 674104	A 671100
Blue	A 674105	
Green	A 674106	
Orange	A 674107	A 671104

MOUNTING BRACKET

Use as a replacement bracket or mount on a second tractor easily utilizing your umbrella on more than one tractor.

Order No.	Price
A 1213511	

TWO-YEAR NO-FAULT WARRANTY ON ALL AUDIOVOX PRODUCTS!



MINI RADIO

Front panel audio aux-in for use with iPods, MP3 players, and portable CD players. Electronic US/Euro AM/FM Tuner. 12VDC Power – no batteries required. 2 Wire Power Connection allows unit to maintain station presets. Clock will run up to 30 days when vehicle battery is disconnected. Completely waterproof; locks out water, dirt, and grime. Unit will withstand even the harshest weather conditions. 7-Channel NOAA weatherband tuner. Weather Alert automatically switches to WB mode when NOAA warning broadcast is received. Corrosion and UV-resistant faceplate. Comes with antenna.

Order No. _____ **Price**
A 1158900

MINI RADIO ACCESSORIES



ANTENNA

6" Rubber Mast
Top/Side Mount

Order No. _____ **Price**
A 1158904



HEADPHONES

Flexible coiled Cord with 1/4" phono plug
Adjustable left-right level controls. Adjustable headband.

Order No. _____ **Price**
A 1158104



SPEAKERS

Two deluxe mini wedge speakers. Can be surface mounted, flush mounted or mounted using included adjustable "U" bracket 30 Watts input. Fully weatherproof for exposed outdoor mounting. Includes wiring and hardware.

Order No. _____ **Price**
A 1158901

RADIO PIGTAILS & WIRING KITS

Description	Order No.	Price
Case '98 or earlier, 6-pin plug	1157003	
Case '99 or later, JD - US current	1157001	
New Holland - Current, McCormick Old	1157004	



WIRE TERMINAL KIT

144 pc. kit contains 3 sizes of splices, 4 sizes of rings, 3 sizes of spades, 2 styles of tabs and size of tab splice.

Order No. _____ **Price**
1-898029



AM/FM FENDER MOUNT RADIO

Large easy to read digital display. 30 station pre-sets, 18 FM and 12 AM. Auto sek and pre-set scan. Bass/Treble/Loudness controls. 3.5 mm headphone jack.

Order No. _____ **Price**
1158447



DASH MOUNT

AM/FM/WB/RBDS STEREO RADIO

Heavy duty DIN AM/FM weatherband radio. 4-channel 160 watt pwer amplifier. 30 pre-sets, 7-channel NOAA tuner. Electronic AM/FM US/Euro tunner with RBDS. Segmented high visibility LCD display with clock. Electronic bass, treble, balance and fade. Front aux-in.

Order No. _____ **Price**
A 1158907

BATTERY TO SWITCH CABLES



Fits 1/2" stud.

Length	Gauge	Order No.	Price
12"	2/0	A 570900	
24"	2/0	A 570901	
36"	2/0	A 570902	
48"	2/0	A 570904	
60"	2/0	A 570905	
72"	2/0	A 570906	

Fits up to 3/8" stud.

Length	Gauge	Red		Black	
		Order No.	Price	Order No.	Price
10"	2	A 500100		A 501200	
15"	2	A 500101		A 501201	
20"	2	A 500102		A 501202	
23"	2	A 500103		A 501203	
27"	2	A 500104		A 501204	
32"	2	A 500105		A 501205	
34"	2	A 500106		A 501206	
38"	2	A 500107		A 501207	
43"	2	A 500108		A 501208	
48"	2	A 500109		A 501209	
53"	2	A 500110		A 501210	
58"	2	A 500111		A 501211	
65"	2	A 500112		A 501212	
72"	2	A 500113		A 501213	

SWITCH TO STARTER CABLES

Fits up to 3/8" stud.

Length	Gauge	Red		Black	
		Order No.	Price	Order No.	Price
16"	2	A 490200		A 491206	
18"	2	A 490201		A 491207	
24"	2	A 490202		A 491208	
32"	2	A 490203		A 491209	
40"	2	A 490204		A 491210	
49"	2	A 490205		A 491211	

BATTERY ACCESSORIES



ATV, LAWN & GARDEN BATTERY KIT

Suited for ATV's, Garden Tractors & snowmobiles. Includes 8' of 8 ga cable with four 5/16" lugs.

Order No. _____ **Price**
A 22504053



BATTERY POST/TERMINAL CLEANER

Cleans battery terminals and posts. Internal and external wire brushes are built into metal case.

Order No. _____ **Price**
570907

SWITCHES



UNIVERSAL PUSH BUTTON

STARTER SWITCH

Insulated type. 2-screw terminals. Mounts through 5/8" hole.

Order No. _____ **Price**
A 1506427



IGNITION STARTER SWITCH

4-position; left accessories; center off; right accessories and ignition; extreme right start. 4-stud terminals. 7/16" long, 3/4" diameter mounting stem. 2 brass keys. 1-1/8" mounting nut.

Order No. _____ **Price**
A 782979



2-POSITION TOGGLE SWITCH

2 screw terminals with nickel plated off-on indicator plate assembled. 15/32" long and 15/32" diameter mounting stem. 2 amps @ 250V DC; 6 amps @ 125V DC.

Order No. _____ **Price**
A 820007



HEAVY-DUTY PUSH-PULL SWITCH

2-terminal, 2-position off-on. 1/2" long, 7/16" diameter mounting stem. Natural plastic knob. 25 amps @ 6V DC; 15 amps @ 12V DC.

Description _____ **Order No.** _____ **Price**
1/2" threaded shaft A 782953

GROUND STRAPS



Length	Gauge	Order No.	Price
7"	2	A 570390	
9"	2	A 495325	
11"	2	A 570416	
14"	2	A 840272	
16"	2	A 840280	
19"	2	A 840292	
24"	2	A 840306	
27"	2	A 840297	

Fits up to 3/8" stud.



HEAVY-DUTY UNIVERSAL TERMINALS

Fits 6 to 2/0 gauge cables. Set of 2.

Order No. _____ **Price**
A 570922



QUICK CONNECT BATTERY TERMINAL

Designed for top post batteries. The cable easily detaches from the battery for anti-theft protection.

Order No. _____ **Price**
A 570919



BATTERY TERMINAL SPREADER

Forged steel construction. Insulated handles. Engineered specifically for battery care and maintenance.

Order No. _____ **Price**
A 570914



4" PEDESTAL REPLACEMENT INCANDESCENT LIGHTS

Description	Order No.	Price
Amber	A 2353038	
Red/Amber	A 2353039	
Red/Black	A 2353040	



DUAL BEAM SPOT LIGHT

- 12V, 55W
- 2 - H3 Halogen Bulbs

Order No.	Price
A 2353042	



12V PEDESTAL MOUNT STEEL LIGHT

Sealed beam. H3 bulb.

Order No.	Price
911005	



12V WORK LIGHT

Plastic housing cushions the 12V H3 bulb from road shock and vibration. Universal 5/16" stud. 15" wire leads exit through the stud. Fully adjustable. On-off switch on back. *Replacement bulb only.

Order No.	Price
917005	
A 918005*	



5" RUBBER TRACTOR IMPLEMENT LIGHT

Durable, molded weatherproof housing cushions the sealed beam from road shock and vibration. Universal 5/16" stud and adjustable bracket allows mounting in any position. 10" lead wire. Trapezoid beam.

12 Volt Order No. 2352904



LED HEAVY-DUTY TOWING LIGHTS

- 30 Ft Cord
- 4R Plug
- 7 Ft Span
- Stop-Turn-Tail

Order No.	Price
A 2353041	



HEAVY-DUTY MAGNETIC SPOTLIGHT

- 25 Ft Cord
- Includes 4-Pin Plug & Heavy-Duty Cable

Order No.	Price
A 2353105	

Includes 2 Lights!



STANDARD LIGHT KIT

- Includes LH and RH dual lamps meet ASAE S279
- Amber lens front and rear 4CP to side, red lens rear only
- 35' wishbone wiring harness with 7 pin ag plug and tri-plugs
- 5' convuluted tubing for protection in critical areas

Order No.	Price
A 2353030	

Easy Magnet Mounting



DELUXE TRANSPORT KIT WITH BRAKE LIGHTS

- LH and RH heavy-duty dual lamps with brake function meet ASAE 279.
- Amber lens front and rear 4CP to side, red lens rear only
- 46' round wishbone wiring harness with 7 pin ag plug and SQ-4 plugs
- 4 - 90 lb. magnets for mounting

Order No.	Price
A 2353031	



HD DUAL LAMP W/ BRAKE

Heavy-duty dual lamp with brake function meets ASAE S279. Amber lens front and rear, 4CP to side. Red lens rear only lamps have a SQ-4 plug. Mounts either righthand-horizontal or lefthand vertical.

Description	Order No.	Price
RH/Horizontal - LH/Vertical	A 2353034	
LH/Horizontal - RH/Vertical	A 2353035	



3" x 5"



4" x 6"



A 822033

RECTANGULAR HALOGEN TRACTOR AND WORK LIGHT

Durable, black polycarbonate housing. Hollow mounting bolt and heavy-duty bracket.

Type	Order No.	Price
3" x 5" flood	2352938	
3" x 5" trapezoidal	2352854	
4" x 6" flood	2352862	
4" x 6" trapezoidal	2352870	
4" x 6" with grill	A 822033	



HID WORK LIGHTS

9-32V 35 watt 3.5 amp. Weatherproof aluminum alloy housing. Stainless steel brackets. 5.9" x 3.9" x 5.7"

Description	Order No.	Price
Full Flood Beam	A 2352875	
Spot Beam	A 2352874	

HID WORK LIGHTS

Spot Beam. 9-32V 35 watt 3.5 amp. Weatherproof nylon cover. Stainless steel stand. 4.6" x 4.4" x 5.7"

Order No. A 2352872



MAGNET KIT

Set of 4 90lbs pull magnets. For use with lights 2353030, 2353031, 2353034, 2353035

Order No.	Price
A 2353032	



WIRING KIT

Complete wiring kit includes illuminated rocker switch, 30-amp relay, color coded terminated wires and fuses.

Order No.	Price
A 2353787	

REPLACEMENT HEADLAMPS

Size	Volts	Order No.	Price
4-1/2" Round Sealed Beam	6	A 508390	
4-1/2" Round Sealed Beam	12	A 897868	
5-1/2" Round Sealed Beam	6	A 508416	
5-1/2" Round Sealed Beam	12	A 508424	
55 Watt H1 Halogen Bulb	12	916005	



R-Series®

This model is designed to retrofit PAR36 work lights. The R-Series fits into most round light cavities on over 400 different models of tractors and is quick and easy to upgrade any machine in your fleet. 4-1/2" diameter.



- Lifetime Warranty
- Made In USA
- 3X More Housing Surface For Maximum Cooling.
- Up To 50,000+ Hour Lifespan
- 9 - 36 Volt
- Reverse Polarity
- 20' Wire Harness With Rocker Switch
- Waterproof Deutsch Connector
- -40° F to 145° F Operating Temp
- Bracket Included

Lumens Actual	Shape	Pattern	Order No.	Price
1800	Round	Flood	BRD1800	

Dually XL™

Everything you expect from the innovative D-Series is now available in a bigger and brighter package. Includes unbreakable polycarbonate lens, durable UV-resistant polyester powder coat, stainless steel hardware and vibration isolator.



Size	Lumens Actual	Shape	Pattern	Order No.	Price
5" x 3-5/8"	3096	Square	Drive	LSD3096	

D-Series®

The D-Series lights produce extremely high output while consuming very little power. Its compact size and shape allows the light to fit almost anywhere and can be used in virtually any lighting application. Heavy duty and flush mount.

Available In Sets Of 2 For Additional Savings!



Size	Lumens Actual	Shape	Pattern	Order No.	Price
5" x 3-5/8"	1568	Square	Flood	LSF1568SET	
5" x 3-5/8"	1568	Square	Flood	LSF1568	
5" x 3-5/8"	1568	Square	Spot	LSS1568	
5" x 3-5/8"	1568	Square	Spot	LSW1568SET	

SR-M® and SR-Q®

The very compact yet efficient SR-M is ideal for any lighting need you might have. The SR-Q has a sleek, low profile configuration allowing the light to fit almost anywhere, while providing you with the same output as the D-Series.



Size	Lumens Actual	Shape	Pattern	Order No.	Price
4-3/16" x 2-3/8"	880	Rectangle	Flood	LRECF880	
4-15/16" x 1-13/16"	1568	Rectangle	Flood	LRECF1568	
4-15/16" x 1-13/16"	1568	Rectangle	Flood	H90511*	

*This is a pair of LRECF1568.

SR-Series®

The SR-Series LED light bars provide a sleek, yet powerful low profile lighting solution that measures less than 2" tall. The SR-Series is designed to project light at extreme distances while consuming very little power.

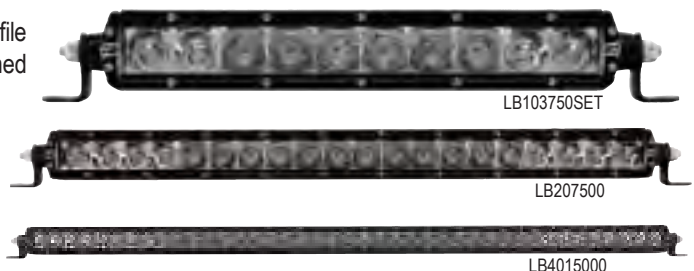

Size	Lumens Actual	Shape	Pattern	Order No.	Price
10"	3750	Straight	Combo	LB103750SET	
20"	7500	Straight	Combo	LB207500	
40"	15000	Straight	Combo	LB4015000	



- *Made In USA*
- *Meets or Exceeds OEM Specifications.*
- *Industry Leading Performance And Reliability.*
- *Designed To Withstand The Rigors And Abuse of Agriculture, Off-Road And Construction.*
- *Honest Real-World Performance Ratings.*

This model is designed to retrofit PAR36 work lights. They are a superior upgrade over bulb-based work lights.

- Most popular model of replacement LED.
- PAR36 standard size fits numerous manufacturers and models.
- Broad applications across wide array of equipment.

Size	Lumens Actual	Shape	Pattern	Order No.	Price
4.5"	1020	Round	Flood	BRF1020	
4.5"	1020	Round	Trap	BRT1020	

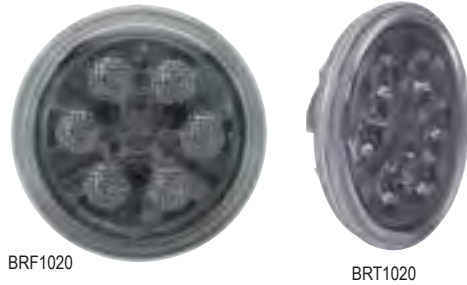

This model is a perfect retrofit for GE H4360-12V sealed beams. The durable construction and bright, white light produced by state-of-the-art LED's combine to make this model brighter and more reliable than any bulb-based 5" x 2" light.

- Popular model for many direct-fit, upgrade tractors.
- Replaces John Deere #R161288

Size	Lumens Actual	Shape	Pattern	Order No.	Price
5" x 2"	1000	Rectangle		LREC998	

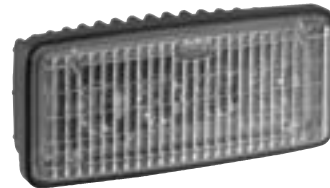

This narrow oval LED work light was designed with agriculture in mind.

- Direct replacement for John Deere part numbers RE269638 and RE269640.

Size	Lumens Actual	Shape	Pattern	Order No.	Price
7" x 3"	2200	Oval Flood		LOF1600	



A slimmer and more powerful version than most PAR36 work lights. The polycarbonate housing and lens make it one of the most durable work lights on the market.

- Another unique torture tested light

Size	Lumens Actual	Shape	Pattern	Order No.	Price
4.5"	860	Round	Flood	LRF860	
4.5"	860	Round	Trap	LRT860	



SAFETY EQUIPMENT

A 400001



SLOW MOVING VEHICLE EMBLEMS

Designed for use on slow-moving vehicles for both day and night. Weatherproof and approved by the National Institute for Farm Safety, National Safety Council and many other safety organizations.

Description	Order No.	Price
Pre-positioned Decal Only	A 317842	
Film mounted on a pre-punched metal backing.	A 317834	
Metal backed SMV sign. ASAE S276.6	A 317835	
Plastic Emblem	A 960617	
26" mounting pole assembly (socket not included)	A 317867	
Spade mounting assembly. (socket not included)	A 317875	
Mounting socket with nuts and bolts.	A 317859	
SMV mounting pack. Contains bolts, spade and socket.	400001	

ADHESIVE SAFETY STRIPS

Contains four 2" x 9" strips. For slow moving trailers or implements.



Color	Order No.	Price
Red/Silver	A 2353753	
Red	A 2353754	

SAFETY LIGHTS

Flasher/Steady Beam



LED 2 FUNCTION SAFETY LIGHTS W/HD MAGNETS

- 6" x 4"
- Long Lasting.
- Battery-operated. Uses 4 AA.

Description	Order No.	Price
Amber	921005	
Red	923005	

Flasher/Steady Beam



ADJUSTABLE MAGNETIC BASE EMERGENCY LIGHT

- 6" x 4"
- Long Lasting.
- Battery-operated. Uses 4 AA.

Description	Order No.	Price
Amber	924005	

WHITE LED EMERGENCY LIGHTS

- 4" x 6.25"
- 18 LED Flasher/Steady Beam
- Battery-operated. Uses 4 AA.

Description	Order No.	Price
Magnetic/Free Standing	929005	
Heavy Duty, Magnetic	930005	



EMERGENCY FLASHERS

These lightweight 12-volt flashers have a 4-wire flat plug. Complete with 20' cord and powerful magnetic case. Highly visible red lenses with black backs can be seen for a mile. Exceeds DOT standards.

Order No. A 27615



HAZARD FLASHERS

Auxiliary warning light for farm equipment, trucks, trailers and boats. Battery operated with no wiring, no hook-up and no assembly required. One full mile of visibility. Magnetic base mount.

Order No. A 535799



ENGINE HEATERS

MAGNET HEATER

Universal application utility heater provides magnetically attached heat when and where you need it. Two floating magnets hold on uneven surface. 200 watts, 120 volts. 6' grounded cord. Built in thermostat maintains optimum temperature, will not exceed 250° F.



Order No.	Price
A 225490	

UNIVERSAL HOT PAD HEATER

Use on oil pans, transmission pans, hydraulic tanks, diesel tanks or water tanks. Heater is silicone covered, acid resistant and pliable. Place on metal reservoir before plugging in. 4" x 5" pads.



Oil Pan Size	Watts	Order No.	Price
2-5 quart	100	A 225480	
5-8 quart	150	A 225481	
8-20 quart	250	A 225483	

LOWER RADIATOR HOSE HEATERS

Efficient engine heating from permanent steel design. Thermostatically controlled to ensure optimum temperature. Easy to install. Not for use on flexible wire reinforced hose. Radiator clamps, 44" power cord and installation instructions included.



Hose I.D.	Watts	Order No.	Price
1-1/4" hose	375	1050848	
1-1/2" hose	600	A 1050855	
1-3/4" hose	600	1050863	
2" hose	600	A 1050871	

EXTERNAL TANK HEATERS

For liquid cooled engines. Heater is thermostatically controlled and has a check valve to ensure one-way coolant flow. Allows faster, easier starting and provides quicker defroster and heater action. Includes heater, fittings, clamps and 4' grounded power cord.



Watts	Order No.	Price
850	225466	
1500	225474	

FREEZE PLUG HEATERS

The choice of professional installers. The highest rated, most efficient type of heater. OEM approved design for precision fit. Replaceable, grounded, molded silicone or vinyl cord. Durable die-cast aluminum or forged brass mounting flange for maximum life. Complete installation instructions included. 600 watt, 120 volt heaters unless otherwise indicated.



Application	Size	Order No.	Price
Allis Chalmers 170 Diesel	1-1/4"	1050954	
Ford NAA, 500, 600, 700, 800, 900, 901, 1800 Gas or Diesel, 2000, 2100, 4000 Gas or Diesel, 4110 Diesel, 4120, 4121; with 134, 172, 192 C.I.D. engines.	2-1/16"	2356467	
Ford 3000, 4000, 5000, 8000, 9000 (1968-70)	1-3/4"	1050913	
Ford 3000, 4000, 5000, 7000, 8000, 9000; 1970-later	1-1/2"	1050962	
International 460, 560, 660, 706, 806, 1206, 1256; all with D 282 or D407 engines. 1963-67 models.	1-5/8"	2356475	
International 966, 1066, 1086, 1466	1-1/4"	1050954	
John Deere 50, 60, 70, 730, A, B, D, G 400 watt, 120 volt.	3/4"	2356483	
Massey MF-175, 180, 265 (AD4-236); MF-35, 50, 150, 203, 205			
235, 2135, 2200 (AD3-152), MF-1100, 1105, 1130, 1135 (A6-354)	1-1/4"	1050954	
Massey MF65, 302, 304, 165, 255, 365, 3165, (AD4-203); MF-90, 1080, 1085, 285 (A4-300)	3/4"	2356483	

TRACTOR TOOL BOXES



16-1/4" L x 4-3/4" W x 5" T.Gray
Order No. HTNY51441
Price

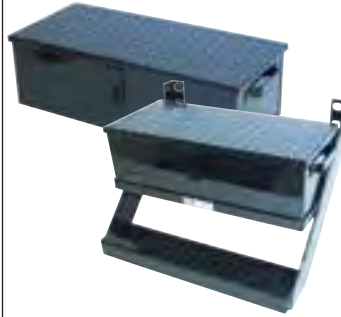

Made of heavy gauge steel. Universal mounting, safety tread lid. Easy removal from tractor. Universal mounting brackets included. 23"L x 10"W x 7"D. Color: Black.

Description	Order No.	Price
Tool Box	966416	
Tool Box and Step	A 966418	

UNIVERSAL TOOL BOXES



Made of heavy gauge steel. 16" x 4.5" x 4.5"

Order Number	Color	Price	Order Number	Color	Price
A 710996	Red		A 711002	Green	
A 711001	Black		A 742442	Blue	

FENDER MOUNT



Description	Order No.	Price
Gray. 11"x 4.25" x 4"	A 742440	

HEAVY-DUTY REMOVABLE TOOL BOX

Easy removal from tractor. Made of heavy gauge steel. Includes mounting bracket. 20" x 6-1/2" x 5".



Color	Order No.	Price
Red	A 710998	

HEAVY-DUTY WITH HANDLE

Made of heavy gauge steel. Includes mounting bracket. 16" x 6-1/2" x 5".



Order Number	Color	Price
A 710997	Green	
A 710999	Red	

MIRROR EXTENSION KITS

Kit includes set of large mirrors, left and right arms and hardware unless otherwise noted. Mirror Size: 8.5 x 16" • Extends 22" - 31".
 *Hardware Not Included.

Fits	Order No.	Price
CASE-IH Maxxum 100, 110, 115, 120, 125, 130, 140. Puma 115, 125, 140, 155, 165, 180, 195, 210, 225, MXM 120, MXM 130, MXM 140, MXM 155, MXM 175, MXM 190 MX 100, MX 120, MX 180, MX 200, MX 210, MX 220, MX 230, MX 240, MX 245, MX 255, MX 270, MX 275, MX 285, MX 305. Magnum 180, 190, 210, 215, 245, 255, 275, 305, 335. 7110, 7120, 7130, 7140, 7150, 7210, 7220, 7230, 7240, 7250, 8910, 8920, 8930, 8940, 8950	A 700500*	
	A 700505*	
	A 700510	
JOHN DEERE 2140, 2350, 2355, 2550, 2750, 2755, 2940, 2950, 2955, 3055, 3150, 3155, 3255, 4030, 4040, 4050, 4055, 4230, 4240, 4250, 4255, 4350, 4430, 4440, 4450, 4455, 4555, 4560, 4630, 4640, 4650, 4755, 4760, 4840, 4850, 4955, 4960, 8450, 8630, 8650. 7630, 7730, 7830, 7920, 7930, 8100, 8110, 8120, 8130, 8220, 8230, 8310, 8320, 8330, 8400, 8410, 8420, 8430, 8440, 8520, 8530, 8560, 8570, 8630, 8640, 8650, 8760, 8770, 8850, 8870, 8960, 8970, 9100, 9120, 9200, 9220, 9300, 9320, 9330, 9400, 9420, 9430, 9520, 9530, 9620, 9630	A 700515	
	A 700520	
Allis Chalmers 190, 6070, 7010, 7020, 7030, 7060, 8010, 8030. Case-IH 695, 806, 826, 870, 966, 970, 986, 1066, 1086, 1175, 1370, 1450, 1466, 1486, 1586, 2090, 2290, 2390, 2590, 2670, 3594, 3688, 4490, 4586, 4690, 5088, 5120, 5130, 5140, 5220, 5230, 5240, 5250, 5288, 5488, 9150, 9230, 9270, 9330. Ford TW30, 6610, 7710, 9600TV140. John Deere 3520, 4320, 4520, 4720, 5075, 5085, 5095, 5101, 5105, 5200, 5210, 5225, 5300, 5310, 5320, 5325, 5400, 5410, 5420, 5425, 5500, 5510, 5520, 5525, 5603, 5625, 6100, 6110, 6115, 6130, 6140, 6200, 6210, 6215, 6230, 6300, 6310, 6320, 6330, 6400, 6405, 6410, 6415, 6420, 6430, 6615, 6715, 7130, 7200, 7210, 7220, 7230, 7320, 7330, 7400, 7420, 7430, 7510, 7520, 7600, 7610, 7700, 7710, 7720, 7800, 7810, 8245, 8270, 8295, 8320, 8345. Massey Ferguson 1155, 1805, 2475, 2705, 2675, 4840. Versatile 700, 855, 875, 895, 936, 9480. White 2-155, 4-150	A 700525*	



BULLDOG® TUBE MOUNT JACKS

J01-0190



Made in the U.S.A.

J01-0160



SIDE WIND

Load Capacity	Retracted Size	Extended Size	Clearance	Travel	Order No.	Price
2000 lbs.	11-1/4"	21-1/4"	6-1/4"	10"	J01-0105	
Replacement Tube Only						
2000 lbs.	14-1/2"	29-1/2"	12"	15"	J01-0190	
Replacement Tube Only						
5000 lbs.	15"	30"	6-1/4"	15"	J01-0110	
Replacement Tube Only						
5000 lbs.	10"	20"	6-1/4"	10"	J01-0100	
7000 lbs.	10-3/4"	20-3/4"	6-1/4"	10"	J01-0175	
7000 lbs.	15-3/4"	30-3/4"	6-1/4"	15"	J01-0185	

TOP WIND

Load Capacity	Retracted Size	Extended Size	Clearance	Travel	Order No.	Price
2000 lbs.	11-1/4"	21-1/4"	7-1/4"	10"	J01-0120*	
2000 lbs.	14-1/2"	29-1/2"	13-1/4"	15"	J01-0125*	
5000 lbs.	11-1/4"	21-1/4"	7-1/4"	10"	J01-0160	
5000 lbs.	14-1/2"	29-1/2"	13-1/4"	15"	J01-0165	
7000 lbs.	10-3/4"	20-3/4"	8-1/2"	10"	J01-0170	
7000 lbs.	15-3/4"	30-3/4"	8-1/4"	15"	J01-0180	

* REPLACEMENT PARTS FOR JACK NO. J01-0120 and J01-0125

Replacement Jack Handle	J01-0010
Replacement Tube Section	J01-0015
Repair Kit - Contains 1-1/2" plunger pin, pull ring, spring, washer, cotter pin	J01-0040

WELD-ON DROP LEG JACKS



J01-0216

SIDEWIND

Load Capacity	Retracted Size	Travel	Order No.	Price
7000 lbs.	25.5"	15"	J01-0212	
12000 lbs. with return spring	28.5"	25.5"	J01-0216	

A-FRAME JACKS - TOPWIND



J01-0230



J01-0235



J01-0250

Load Capacity	Retracted Bracket Height	Extended Bracket Height	Top Clearance Height	Travel	Order No.	Price
2000 lbs. with foot	8"	23-1/4"	14-1/2"	15"	J01-0230	
5000 lbs. without foot	8"	23-1/4"	14-1/2"	15"	J01-0235	
Foot for J01-0135. Includes hardware. Fits 2" tube. 1.7" tall						
					J01-0250	

IMPORT IMPLEMENT JACKS



J01-0225

Greaseable gears. Includes weldable mating pipe end, pin and chain. Durable powder coat and zinc finish

TUBE MOUNT SIDEWIND

Load Capacity	Travel	Retracted Bracket Height	Extended Bracket Height	Top Clearance Height	Order No.	Price
2000 lbs.	10"	10-7/8"	21"	5-7/8"	J01-0205	
2000 lbs.	15"	14-3/4"	29-7/8"	12"	J01-0290	
5000 lbs.	15"	14-3/4"	30"	6-7/8"	J01-0210	

J01-0210

TUBE MOUNT TOPWIND

Load Capacity	Travel	Retracted Bracket Height	Extended Bracket Height	Top Clearance Height	Order No.	Price
2000 lbs.	10"	11-1/4"	21-3/8"	6-7/8"	J01-0220	
2000 lbs.	15"	15"	30-1/4"	7-3/4"	J01-0225	
5000 lbs.	10"	11-1/4"	21-3/8"	6-7/8"	J01-0260	
5000 lbs.	15"	15"	30-1/4"	7-3/4"	J01-0265	

48" HI-LIFT FARM JACK



A 195313

Width:	5"
Height:	50.75"
Depth:	9.63"
Rated Load:	4660 lb.s.
Tested Load:	7000 lbs.
Winching:	5000 lbs.
Max Lift Height:	36.63"
Min. Lift Height:	4.5"

Order No.	Price
J01-0485	

Made in the USA

FIX-IT KIT - Includes principal parts for service.

Order No.	Price
195311	

WELD-ON - BRACKET MOUNT

Lift Capacity: 2000 lbs
Travel: 10"
Retracted Bracket Height: 10-1/4"
Extended Bracket Height: 20-3/8"
Top Clearance Height: 7-3/4"

Order No. J01-0215

SIDE WIND TRAILER JACK

Load Capacity: 1000 lbs with 6" diameter caster
Retracted Size: 23-1/4"
Clearance: 12.7"
Travel: 10"



Order No. J01-0217

EXHAUST PIPES & EXTENDERS

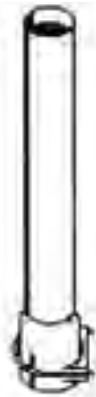

Black Steel Straight Pipes

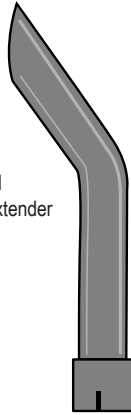

Black Steel Exhaust Extender



Curved Stacks



Straight Stacks

STEEL STRAIGHT PIPES

48" long - clamp included.

Inside Diam.	Order No.	Price
1-1/2"	A 495069	
1-3/4"	A 495077	
2"	A 495085	
2" x 24"	A 495080	
2-1/4"	A 495101	
2-3/8"	A 495127	
2-1/2"	A 495093	
2-3/4"	A 495119	
3"	A 495143	
3-1/2"	A 495150	
3-3/4"	A 495168	
4"	A 495176	

STEEL CURVED PIPE

18" extender - clamp included.

Inside Diam.	Order No.	Price
1-1/2"	A 495200	
1-3/4"	A 495218	
2"	A 139386	
2-1/4"	A 495309	
2-1/2"	A 139402	
2-3/8"	A 139410	
2-3/4"	A 495333	
3"	A 139428	

CURVED STACKS

Aluminized O.D.

Diam.	Length	Order No.	Price
3"	36"	A 1032945	
4"	36"	A 1032960	

Chrome O.D.

Diam.	Length	Order No.	Price
3"	48"	A 1032861	
3.5"	36"	A 1032879	
3.5"	48"	A 1032887	
4"	48"	A 1032903	

Chrome I.D.

Diam.	Length	Order No.	Price
3"	48"	A 1032804	
3.5"	36"	A 1032812	
3.5"	48"	A 1032820	
4"	36"	A 1032838	
4"	48"	A 1032846	

STRAIGHT STACKS

Chrome O.D.

Diam.	Length	Order No.	Price
4"	36"	A 1033174	

STRAIGHT RADIATOR HOSE



Conforms to Spec. SAE 20R4, Class R, Grade 1. Sizes expressed I.D. x length.

Size	Order No.	Price
1-1/4" x 3"	A 649038	
1-1/4" x 8-1/2"	A 649301	
1-1/2" x 6"	A 648899	
1-1/2" x 8-1/2"	A 649020	
1-1/2" x 12"	A 648931	
1-5/8" x 3"	A 649376	
1-3/4" x 7"	A 649236	
2" x 3-3/4"	A 648857	
2-1/8" x 4-1/2"	A 649624	
2-1/4" x 3"	A 649632	
2-1/4" x 9"	A 649640	
2-3/8" x 6"	A 649137	
2-1/2" x 8"	A 649657	
2-7/8" x 6"	A 649053	

MUFFLER CLAMPS



Diameter	Order No.	Price
1-1/2"	A 26534	
1-5/8"	A 26609	
1-3/4"	A 26567	
1-7/8"	A 26625	
2"	A 26633	
2-1/4"	A 26732	
2-1/2"	A 26773	
2-3/4"	A 267775	
2-5/8"	A 26774	
3"	A 1053289	
3-1/4"	A 1053292	
3-1/2"	A 1053297	
4"	A 1053305	

EXHAUST CAPS



Installs in seconds with a single bolt.

Diameter	Order No.	Price
1-1/2" to 1-11/16"	A 90134	
1-3/4" to 1-15/16"	A 90142	
2" to 2-3/16"	A 90159	
2-1/4" to 2-7/16"	A 90167	
2-1/2" to 2-11/16"	A 90175	
2-3/4" to 2-15/16"	A 90183	
3" to 3-3/16"	A 90191	
3-1/2" to 3-9/16"	A 567453	
4"	A 648725	
4-1/2"	A 648750	
5"	A 648753	

A 700130



LEVER ACTION

Positive locking plunger will not unlock while filling. Refill with grease cartridge or bulk.

Description	Order No.	Price
Grease Gun	A 700130	

HEAVY DUTY LEVER ACTION

Features bulk loader, air bleeder valve, 6" steel extension and 4-jaw coupler with ball check. Capacity: 14 oz cartridge or 500 cm bulk fill. 1/8" NPT threads. 10,000 PSI

Description	Order No.	Price
Grease Gun	A 700140	

A 700140

A 700135



PISTOL GRIP

Frees One Hand. Refill with Cartridge, Bulk or Dispenser. 5,000 psi Or More with Minimum Effort.

Description	Order No.	Price
Grease Gun	A 700135	



HEAVY DUTY PISTOL GRIP

Features 3-way loading capability. Air bleeder valve, 6" steel extension with hydraulic coupler. Check valve to prevent bypass. Chrome plated finish. 6,000 PSI

Description	Order No.	Price
Grease Gun	A 700145	

A 700145



GREASE GUN HOLDER

Holds any grease gun, barrel pump or suction gun with standard 2-1/4" outside diameter barrel. Works in any position. Mounts on tractor or other machinery under any nut or bolt.

Order No.	Price
A 22020	



SAE GREASE FITTINGS

50 piece set includes 1/4" - 28 taper thread straight, 45 degree and 90 degree.

Order No.	Price
A 1164835	



METRIC GREASE FITTINGS

50 piece set includes 6 mm x 1 mm taper thread straight, 45 and 90 degree. 8 mm x 1mm taper thread straight, 45 and 90 degree.

Order No.	Price
A 1164837	



GREASE FITTINGS

100 piece set. Includes 12 different sizes.

Order No.	Price
1-898017	



FLEXIBLE WHIP HOSE

12" Long with 1/8" N.T.P. Male. Fittings at each end.

Order No.	Price
A 580121	



UNIVERSAL THIN NOSE COUPLER

Longer lasting. 19/16" x 1/8" pt. female.

Order No.	Price
A 1031863	



HEAVY-DUTY NEEDLE ADAPTER

Designed for U-joints and bearings located in a position where lateral movement necessary for the release of couplers is impossible.

Order No.	Price
A 22038	

FLEXIBLE GREASE HOSE

Flexible grease tube for getting those hard to reach fittings. Fits all standard grease guns. 18" Heavy-Duty

Order No.	Price
A 21725	



A 1161702



A 1161706



A 1161708

GALVANIZED STEEL FUNNELS

Heavy duty construction for rugged use. Rolled edge, high, splash proof rim. Fluted bottom to prevent swirling. Comes with a fine mesh SS strainer.

Capacity	Opening Diameter	Length Of Spout	Spout Opening	Overall Height	Order No.	Price
2 qt.	8-1/2"	3-1/4"	1/2"	8"	A 1161702	
6 qt.	8-1/2"	3-1/4"	1-7/8"	14-1/2"	A 1161706	
8 qt.	9-1/2"	3-3/4"	1-1/4"	11-1/2"	A 1161708	



GALVANIZED FUNNEL WITH FLEXIBLE PIPE AND SCREEN

Heavy duty galvanized steel construction. Comes with fine mesh ss strainer. 12" flex metal spout with taper tip for hard-to-reach spots.

Order No.	Price
A 1161704	



HEAVY DUTY GREASE FITTING REJUVENATOR

Force penetrating oil through the grease fitting rejuvenator to open clogged grease joints and fittings in less than a minute. Includes a 5" flex hose for hard to reach fittings and heavy duty carrying case.

Order No.	Price
500630	



POCKET GREASE FITTING UNCLOGGER

This revolutionary tool will open stuck grease fittings with powerful hydraulic impact. Softens dried-out grease inside joints and allows you to grease neglected steering, suspension and driveline joints.

Description	Order No.	Price
Small enough to fit in your pocket. Features stainless steel body and pocket clip.	500635	



Rigid Type



Flex Type

PISTOL TYPE OILERS

A full range of professional oilers for all liquid dispensing applications. Bodies and pumps are 100% steel for extra strength and superior performance for all liquid dispensing applications.

Description	Order No.	Price
6 oz. with flex spout	500581	
8 oz. with rigid spout	500595	
16 oz. with rigid spout	500602	
12 oz. with flex spout	500588	



UNIVERSAL BEARING PACKER

Place bearing between plastic cones, tighten and force grease through the fitting on the end of the the shaft.

Order No.	Price
500609	

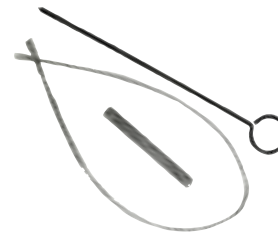

OIL SEAL REMOVER & INSTALLER

"Chinese finger" design extracts and installs a new wick-type seal without removing the engine or crankshaft. Includes wick seal remover, Chinese finger wire mesh installer and handle.

Order No.	Price
900500	



ULTRA COPPER® RTV SILICONE GASKET MAKER

For 4-cylinder, turbocharged or high performance engines. Temperature range -75°F to 700°F intermittent. Suggested for exhaust manifolds/headers, valve covers, oil pans, timing covers, water pumps, thermostat housings. 3oz. tubes, carded. Sold in boxes of 12.

Order No.
81878



ULTRA BLUE® RTV SILICONE GASKET MAKER

Temperature range -75°F to 500°F. Suggested applications: valve covers, oil pans, timing covers, transmission pans, differential covers. 3.35 oz. tubes, carded. Sold in boxes of 6.

Order No.
81724



SENSOR-SAFE BLUE RTV SILICONE GASKET MAKER

Temperature range -65°F to 500°F intermittent. Will not foul oxygen sensors. Suggested applications: valve covers, oil pans, timing covers, water pumps, thermostat housings, transmission pans. 3oz. tubes, carded. Sold in boxes of 12.

Order No.
80022



HIGH-TEMP RED RTV SILICONE GASKET MAKER

Formulated for hi-temp applications, or heavy-duty use. Makes reliable "formed in-place" gaskets. Coats precut gaskets to increase reliability. Temperature range -75°F to 650°F intermittent; Suggested applications: valve covers, oil pans, timing covers, water pumps, thermostat housings, transmission pans. 3 oz. tubes, carded. Sold in boxes of 12.

Order No.
81160



INDIAN HEAD® GASKET SHELLAC COMPOUND

Seals in all common gasketing materials in low temperature and low pressure applications. Temperature range -65°F to 350°F. Suggested applications: hose connections, paper/cardboard gaskets. 2 oz. bottles, carded. Sold in boxes of 12.

Order No.
20539



FORM-A-GASKET® NO. 1 SEALANT

Fast-drying, hard-setting sealant designed for sealing rigid materials and flanges, or patching holes and joints where permanent assembly is desired. Temperature range -65°F to 400°F. Resists common shop fluids and fuels. Suggested applications: freeze plugs, threaded connections, manifold gaskets. 3 oz. tubes, carded. Sold in boxes of 12.

Order No.
80008



FORM-A-GASKET® NO. 2 SEALANT

Slow-drying, non-hardening sealant designed for sealing cut gaskets and stamped parts. Allows for easy disassembly if required. Temperature range -65°F to 400°F. Use where sealing is more important than adhesion. Suggested applications: valve cover gaskets, oil pan gaskets. 3 oz. tubes, carded. Sold in boxes of 12.

Order No.
80016



CLEAR RTV SILICONE ADHESIVE SEALANT

General purpose, clear RTV indoor/outdoor sealant. Seals, bonds and repairs: glass, metal, plastics, fabric, vinyl, weather stripping and vinyl tops. Temperature range -80°F to 450°F. Suggested applications: windshields, door frames, electrical connections, vinyl tops, seams and roofs. 3oz. tubes, carded. Sold in boxes of 12.

Order No.
80050



BLACK SILICONE ADHESIVE SEALANT

General purpose, black RTV indoor/outdoor sealant. Seals, bonds and repairs: glass, metal, plastics, fabric, vinyl, weather stripping and vinyl tops. Temperature range -80°F to 450°F. Suggested applications: windshields, door frames, electrical connections, vinyl tops, seams and roofs. 3 oz. tubes, carded. Sold in boxes of 12.

Order No.
81158



HIGH TACK™ GASKET SEALANT

Fast-drying all-purpose sealant dries to a highly tacky, non-brittle film. Temperature range -65°F to 500°F. Resists gasoline, oil, antifreeze, axle lube. Suggested applications: valve cover, carburetor, fuel pump and manifold gaskets. 4 oz. cans. Sold in boxes of 12.

Order No.
80062



MEDIUM STRENGTH THREADBLOCKER BLUE

Ideal for all nut and bolt applications 1/4" to 1" Locks and seals while preventing parts loosening due to vibration. Suggested applications: valve cover bolts, water pump bolts, oil pan bolts, drive shaft bolts, rocker arm adjustment nuts, carburetor studs. Sold in boxes of 12.

Order No.
A 24206



ANTI-SEIZE LUBRICANT

Highly refined blend of aluminum, copper and graphite lubricants. Temperature range -60°F to 1600°F. Suggested applications: spark plugs, cylinder head bolts and exhaust head bolts. 8 oz. bottles. Sold in boxes of 12.s, carded. Sold in boxes of 12.

Order No.
80078



JB WELD COMPOUND

World's finest cold-weld compound. One tube contains liquid steel/epoxy resin and the other contains a hardener. Resistant to 500°F. 2 - 1 oz. tubes

Order No.
A 8265



JB WELD KWIK COMPOUND

World's finest cold-weld compound. One tube contains liquid steel/epoxy resin and the other contains a hardener. Bonds in 4 minutes. Withstands temperatures up to 300°F. 2 - 1 oz. tubes

Order No.
A 8276



NATURAL ORANGE PUMICE HAND CLEANER

Quick-acting lotion formula with scrubbing particles for cleaning a broad range of industrial soils, medium dirts and grease. Contains baby oil. Citrus scent.

Description	Order No.
1-gal. w/pump	95504
1/2 gal. w/pump	95804
14 oz. bottle	95704



UPPER CYLINDER LUBRICANT AND INJECTOR CLEANER (FUEL TREATMENT)

Formulated for gasoline, diesel and LPG engines. It contains no harmful solvents or alcohol. This product is a blend of heat resistant - super slick oils and additives with a high detergent action that cleans and lubricates the fuel system. It also causes the fuel to burn more efficiently for greater fuel economy and fewer emissions. It will negate the harmful effects of "reformulated gasoline" especially in older automobiles and 2-cycle engines. Use in diesel engines to neutralize the harmful effects of low sulphur diesel fuel.

Description	Order No.	Price
5.25 fl oz.	10020	
1-Quart	A 10003	
1-Gallon	A 10013	



HEAVY-DUTY OIL STABILIZER

100% petroleum product formulated to eliminate dry starts and reduce friction, heat and wear in any type of engine. Use in gear oil to stop leaks, reduce operating temperatures and increase the life of the gear oil. Since it is pure petroleum, it can safely blend with all other automotive lubricants, even synthetics, ATF and mineral oil.

Description	Order No.	Price
1-Quart	A 10001	
1-Gallon	A 10002	



12 OZ POWER STEERING STOP LEAK

Totally effective in reducing slack, squeals, and hard spots in worn rack and pinions. Your results will be immediate and long lasting.

Order No.	Price
10008	



HYDRAULIC OIL BOOSTER & STOP LEAK

Formulated to renew hydraulic fluid with an additive package that stops seal leaks, boosts pressure, reduces operating temperatures and increases the life of hoses, rams and cylinders.

Description	Order No.	Price
1-Quart	10019	
1-Gallon	10018	



CHAIN LUBRICANT

All weather, all temperature lubricant and protectant for chains, sprockets, cables and open gears. Water resistant. It should be applied to any nuts, bolts or components that are subject to long term exposure. 1 qt.

Order No.	Price
A 10014	



TRANSMISSION FIX WITH ATF CONDITIONERS

Non-solvent formulas that stops slip, hesitation and rough shifting in worn transmissions and completely eliminates most seal leaks. Use in any transmission for preventative maintenance. 24 Fl. Oz.

Order No.	Price
10009	

HEAVY-DUTY GREASES

Formulated for automotive, agricultural, heavy-duty and industrial applications. It is virtually waterproof and is more stable than all conventional lithium grease. It is fortified with an extreme pressure additive package and it exceeds OEM Lube for Life specifications.

Description	Order No.	Price
14.5 fl oz tube	10301	
16 fl oz tub	10330	



5TH WHEEL LUBE

Clean, easy to use solution to the problem of dry 5th wheels and slider rails. It is virtually waterproof so it won't wash off slider rails on wet roads. 24 fl oz.

Order No.	Price
10030	

AIR TOOL LUBE

Unique formula that was developed for the working professional who demands top performance. It combats rust and varnish and coats the working parts with a cushion of waterproof lubricants that resist blowout. 16 fl oz.

Order No.	Price
A 10216	



GUN OIL

Designed to stand up to the high combustion temperatures of machine guns. It resists evaporation and drying during long-term storage. It is totally odorless and protects against moisture during wet hunting conditions.

Order No.	Price
10006	

TOOL BOX BUDDY

Lubricates better, penetrates deeper and cuts rust faster than any spray product. Excellent for locks, air tools or anything exposed to moisture. Fits easily in any tool box. Excellent for household use. It does not contain harmful solvents. 2 fl oz. Pack size 18x1

Order No.	Price
10070	



CHAIN LUBE

Safe on all chains, non-staining. Prevents corroding and oxidation. Anti-Sling formula stays where you put it. 11 oz.

Order No. A 100082

LIQUID WRENCH

Loosens rusted nuts, bolts and parts. Multi-use penetrant. 12 oz.

Order No. A 100081

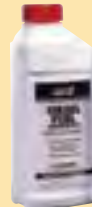

POWER SERVICE DIESEL SUPPLEMENT

Keeps fuel fresh. Removes water and disperses contaminants. Helps prevent gelling. Treats all diesel fuels including ULSD and biodiesel. 32 oz.

Order No. A 100080

DIESEL 9•1•1®

De-ices frozen fuel filters. Reliquefies gelled fuel. Prevents fuel-filter icing. Removes water from fuel system and extends the life of fuel filters, fuel injection pumps & fuel injectors. Treats 30 - 75 gals.

Order No. A 100086



PB BLASTER PENETRATING CATALYST

Loosens rusted joints and frozen parts. Protects against future rust and corrosion and even works on wet parts. Non-evaporating lubricant. 11 oz.

Order No. A 100083

SEAFOAM

Great for cleaning carburetors, flushing impurities out of fuel, decarbonizing pistons and stabilizing fuel for storage.

Order No. A 100084



RED-KOTE FUEL LINER

Designed to seal leaks and prevent further rusting. 1 Qt. 1qt. treats up to 12 gallon tank.

Order No. A 478521

FUEL STABILIZER

Prevents fuel degradation during storage that causes gum and varnish deposits. Cleans, lubricates and maintains fuel pumps, carburetors, fuel injectors and compression rings. Used in all grades of gasoline and in all two and four cycle engines. 1 fluid ounce treats 1 gallon of gasoline.

8 oz. A 10314
32 oz. A 10303



SAFEGUARD™ ETHANOL FUEL CONDITIONER & STABILIZER

Specifically formulated for ethanol based fuels. This applies to E-10, E-15, E-85, pure ethanol and mixtures in between, including gasoline. Completely soluble in all ethanol fuels and will not harm filters. Prevents rust and corrosion associated with the use of ethanol fuels. 1 oz per 5 gallons.

5.25 oz. A 10670
16 oz. A 10576



CONTACT CLEANER

Unique blend of solvents, cleaning agents and propellants designed to remove oil, dirt and moisture from contact points in small electrical equipment, controls, ignition systems, motors, relays and thermostats. Non-chlorinated, CFC free VOC compliant formula dries quickly and leaves no residue. Aerosol.

A 10799



• **AGRICULTURAL/INDUSTRIAL STRENGTH** • **OE FORMULAS** • **SATISFACTION GUARANTEED**

ACCESSORIES



CHAIN & CABLE LUBE

Penetrates rapidly to reduce friction & wear. Resists rust & corrosion. Use on all chain, cables & hinges.

Order No. A10510

Price



BRAKE & PARTS CLEANER

Safely removes fluid, grease, oil & contaminants. Use on all brake parts. Cleans & degreases without leaving residue.

Order No. A10515

Price



GLASS CLEANER

Foaming cleaner. Cleans quickly & easily. Cleans glass, mirrors, plastic & Stainless steel.

Order No. A10520

Price



CARB & CHOKER CLEANER

Remove internal deposits. Use on all engines. Helps eliminate stalling & rough idling.

Order No. A10525

Price



BELT DRESSING/CONDITIONER

Use on fan & V-belts, rubber belts & belt drives. Reduces slippage & noise. Cleans & Lubricates for Longer life.

Order No. A10530

Price



GRAPHITE LUBRICANT

Non-stick. Reduces wear. Long lasting lubrication and protection.

Order No. A10535

Price



TOOLBOX® Z400 ROLL OF SHOP TOWELS

Just the right size to handle your dirtiest and toughest wiping applications around the shop or home. 60 sheets/roll. Sheet size 11" x 9.4". Minimum order of 12 required.

Order No. A 54400

Price



TOOLBOX® Z400 BOX OF CENTER-PULL SHOP TOWELS

Packaged in a cardboard center-pull dispenser box with convenient carrying handle. 200 sheets/box. Minimum order of 6 required.

Order No. A 55202

Price



TOOLBOX® Z400 ROLL OF SHOP TOWELS 6-PACK

Packaged in a very economical way for large volume buyers. 6 rolls, 60 sheets/roll. Sheet size 11" x 9.4". Minimum order of 4 required.

Order No. A 54416

Price



TOOLBOX® Z400 BIG GRIP® BUCKET SHOP TOWELS

Great for jobs outside or wet work sites as it is designed to keep your towels clean and dry. 200 sheets/bucket. Minimum order of 2 required.

Order No. A 55208

Price

KEEP YOUR TRACTOR MOVING WITH A NEW SET OF TIRE CHAINS

Keep your tractor moving with continuous and total traction on mud, snow and other ground conditions. Unique cross chains stand up on tire lugs, are self cleaning and will not bind. **Sold per tire unless otherwise noted.**

SKID LOADER CHAINS (sold in pairs)

Tire Size	Order No.	Each
10 x 15LT	A 949750	
12 x 15LT	A 950261	
31x10.50 x 15LT	A 949982	
31x11.50 x 15LT	A 949982	
31x13.50 x 15LT	A 950261	
32x11.50 x 15LT	A 950261	
33x10.5 x 15	A 950261	
33x12.50 x 15LT	A 950261	
LT235/70 x R15	A 949750	
LT255/75 x R15	A 949750	
LT265/70 x R15	A 949750	
LT265/75 x R15	A 949750	
LT285/70 x R15	A 949982	
LT315/70 x R15	A 950261	
LT325/60 x R15	A 950261	
7.50 x 16LT	A 949750	
8.00 x 16	A 949750	
29x12 x 16	A 949750	
33x12.50 x 16LT	A 949750	
35x12.5 x 16	A 949750	
LT235/80 x R16	A 949750	
LT235/85 x R16	A 950261	
LT235/85 x R16	A 949982	
LT255/70 x R16	A 949982	
LT255/75 x R16	A 949982	
LT265/70 x R16	A 949982	
LT265/85 x R16	A 949982	
LT275/70 x R16	A 950261	
275/75 x R16	A 950261	
LT285/60 x R16	A 950261	
285/70 x R16	A 950261	
LT285/75 x R16	A 950261	
LT295/75 x R16	A 950261	
LT345/55 x R16	A 950261	
31x10.50 x 16.5	A 949982	
9.00 x 16.5LT	A 950261	
10.00 x 16.5LT	A 949750	
12 x 16.5LT	A 950261	
35x7.50 x 16.5	A 950261	
LT255/70 x R17	A 949982	
LT265/60 x R17	A 949750	
LT265/70 x R17	A 949982	
275/55 x R17	A 949750	
275/60 x R17	A 949750	
LT275/70 x R17	A 950261	
LT285/70 x R17	A 950261	
LT345/55 x R17	A 950261	
245/70 x R17.5	A 949750	
LT275/45 x R20	A 949982	

FIELD TYPE - TRACTORS

Tire Size	Order No.	Each
8 x 16	A 948464	
12 x 16.5	A 948471	
15 x 19.5	A 948475	
8.3 x 24	A 948470	
9.5 x 24	A 948472	
11.2 x 24	A 948473	
12.4 x 24	A 948497	
13.6 x 24	A 948940	
14.9 x 24	A 948940	
16.9 x 24	A 950311	
17.5 x 24	A 950311	
18.4 x 24	A 949495	
19.5 x 24	A 949495	
15.5 x 25	A 948935	
17.5 x 25	A 950311	
20.5 x 25	A 948950	
13.6 x 26	A 948940	
14.9 x 26	A 948935	
16.9 x 26	A 950311	
18.4 x 26	A 948946	
11.2 x 28	A 948497	
12.4 x 28	A 949461	
13.6 x 28	A 948935	
14.9 x 28	A 949487	
16.9 x 28	A 949495	
18.4 x 28	A 948946	
15.5 x 28	A 948950	
16.9 x 30	A 948946	
18.4 x 30	A 948950	
11.2 x 34	A 948474	
16.9 x 34	A 948950	
18.4 x 34	A 948976	
11.2 x 36	A 948474	
12.4 x 36	A 948941	
13.36 x 36	A 948476	
13.9 x 36	A 948476	
11.2 x 38	A 948941	
12.4 x 38	A 948941	
13.6 x 38	A 948570	
13.6 x 38	A 948950	
20.8 x 38	A 948479	
18.4 x 38	A 949420	
16.9 x 38	A 948976	



Chain Tighteners (Sold Per Pair)
20" or Larger Rim A 947900

Field Type



Highway Type



HIGHWAY TYPE - TRACTORS

Tire Size	Order No.	Each
13.6 x 16	A 949485	
8.3 x 24	A 949480	
9.5 x 24	A 949481	
11.2 x 24	A 949482	
12.4 x 24	A 948483	
13.6 x 24	A 949488	
14.9 x 24	A 949305	
16.9 x 24	A 949491	
17.5 x 24	A 949491	
18.4 x 24	A 949493	
19.5 x 24	A 949493	
14.9 x 26	A 949490	
16.9 x 26	A 949491	
18.4 x 26	A 949493	
9.5 x 28	A 949482	
11.2 x 28	A 948984	
12.4 x 28	A 949488	
13.6 x 28	A 949305	
14.9 x 28	A 949490	
9.5 x 32	A 948984	
11.2 x 34	A 949486	
16.9 x 34	A 949313	
18.4 x 34	A 949321	
11.2 x 36	A 949486	
12.4 x 36	A 949489	
13.9 x 36	A 949289	
11.2 x 38	A 949486	
12.4 x 38	A 949489	
13.6 x 38	A 949289	
14.9 x 38	A 949498	
15.5 x 38	A 949313	
16.9 x 38	A 948490	
18.4 x 38	A 949412	
18.4 x 42	A 949492	

Highway Type Replacement Link w/ Hook

3/8" thick, 10 links	A 940122
3/8" thick, 13 links	A 940221

Chain Tighteners (Sold Per Pair)

20" or Larger Rim	A 947900
-------------------	----------

AUXILIARY CAB HEATER



20,000 BTU. 12-Volt. Side wall exit hose connections. 2-speed fan. 9-1/2" x 6-1/2" x 7". Rear fan guard. Installation kit included.

Order No.	Price
A 969808	

ASSORTED CLEVIS

Max WWI - Maximum Working Weight



Pin Diam.	Body Diam.	Usable Length	Max WWI	Order Number	Price
1/2"	7/16"	1-11/16"	4000	985850	
5/16"	1/4"	1-1/8"	1000	A 985853	
3/8"	5/16"	1-1/4"	2000	A 985861	
5/8"	1/2"	1-15/16"	6500	A 986125	

TWISTED CLEVIS



A 287946

Pin Diam.	Body Diam.	Usable Length	Max WWI	Order Number	Price
1/2"	5/8"	3"	6000	A 287946	
5/8"	3/4"	3-1/2"	12000	A 908301	
7/8"	15/16"	4-1/4"	20000	C44-0100	
1"	1"	5"	25000	C44-0110	

STRAIGHT CLEVIS



A 908251

Pin Diam.	Body Diam.	Usable Length	Max WWI	Order Number	Price
1/2"	5/8"	3-1/4"	6000	A 908251	
7/8"	15/16"	4-5/8"	20000	C44-0060	
1"	1"	5-5/16"	25000	C44-0070	

GENERAL PURPOSE CLEVIS



A 130716

Pin Diam.	Body Diam.	Usable Length	Max WWI	Order Number	Price
7/16"	3/8"	1-1/4"	2000	C44-0010	
1/2"	7/16"	1-1/2"	3000	C44-0020	
3/4"	3/4"	6-3/16"	10000	A 130716	

LYNCH PINS

LOCKING LYNCH PINS



Description	Diam.	Order No.	Price
Locking lynch pin, plain. Pkg. 5	1/4"	P34-0185B	
Forged lynch pin with snap-lock ring. Pkg. 5	7/16"	P34-0180B	
Heavy duty forged lynch pin with black snap-lock ring. Pkg. 5	7/16"	P34-0190B	
Lynch pin, bracket, and 5" chain assembly			
Bracket for pin when not in use. Set of 2	3/8"	A 2189020	



A 2189020

DOUBLE LOK™ HITCH PINS

Grade 5 pin, double locking, powder coat on pin and handle, quick release handle.

Order No.	Description	Price	Order No.	Description	Price
HP700421	5/8" x 4-1/2"		HP700452	1" x 6"	
HP700431	3/4" x 4-1/2"		HP700462	1-1/8" x 7"	
HP700432	3/4" x 6"		HP700472	1-1/4" x 7"	
HP700441	7/8" X 4-1/2"		HP700492	1-1/2" x 8"	
HP700442	7/8" x 6"				



RATCHET & TURNBUCKLE JACKS

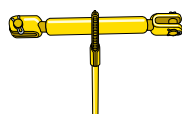

Replaces hydraulic cylinders or screw jacks in uses where infrequent adjustments are needed. All steel. 1-1/4" diameter clevis pin. 20" closed, 28" open.

Description	Order No.	Price
Turnbuckle - 1-1/4" NC threads	J01-0270	

ASSORTED PINS

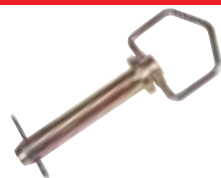

COLD FORGED HITCH PINS

Pin Dia.	Usable Length	Order No.	Price
1/2"	3-1/2"	A 693051*	
5/8"	4-1/4"	A 757039	
3/4"	4-1/4"	A 112151	
7/8"	6-1/4"	A 688572	

* swivel handle



HOT FORGED HITCH PINS

Pin Dia.	Usable Length	Order No.	Price
1/2"	3-1/2"	P34-0055	
5/8"	3-3/4"	P34-0060	
5/8"	6"	P34-0080	
3/4"	4"	P34-0065	
3/4"	6-1/4"	P34-0085	
7/8"	4-1/4"	P34-0070	
7/8"	6-1/2"	P34-0090	
1"	4-1/2"	P34-0075	
1"	6-3/4"	P34-0095	
1-1/8"	7"	P34-0100	
1-1/4"	7"	P34-0105	

RED HEAD FORGED HITCH PINS

Pin with plastisol coated pull ring and hairpin.



A 908111

Pin Dia.	Usable Length	Order No.	Price
1/2"	3-5/8"	A 908111	
5/8"	5-1/2"	A 908145	
3/4"	6-1/2"	A 757047	
7/8"	6-1/2"	A 757054	
1"	8"	A 757055	
1.125"	8-5/8"	A 757056	
1.25"	8-5/8"	A 757057	
1.5"	8-5/8"	A 757058	



A 842302

SAFETY PINS

Pin Dia.	Usable Length	Order No.	Price
1/2"	4"	A 842302	
5/8"	4-1/4"	A 669499	
3/4"	4-1/4"	A 669507	
7/8"	6"	A 842245	



1-898020



1-898027

PIN ASSORTMENTS

Description	Sizes	Pkg.	Order No.	Price
Adjustment Pins	4	14	1-898030	
Clevis Pins	21	50	1-898027	
Hair Pins	7	130	1-898020	
Roll Pins	5	170	1-898021	

HAIR PINS

Wire Dia.	Overall Length	Fits Pin Dia.	Pkg.	Order No.	Price
1/8"	2-1/16"	1/2" to 7/8"	8	P34-0210B	
3/16"	3-3/4"	3/4" to 1-1/4"	5	P34-0215B	
1/4"	4-1/4"	7/8" to 1-1/2"	2	P34-0205B	
5/16"	3-15/16"	3/4" to 1-1/4"	2	P34-0230B	



A 229054

14 Pc. Hair Pin Assortment

3 ea-3/32" and 3/16"
4 ea-1/8" and 5/32"

A 578443

KWIC-TWIST CLIPS

MADE IN THE USA. Design prevents being pulled out by corn stalks & field debris.

Wire Diam.	Overall Length	Overall Length	Pc/Bag	Order No.	Price
3/32"	1-13/16"	1/4" - 3/8"	2	H63912	
5/32"	3"	1/2" - 5/8"	2	H63922	
5/32"	3-3/8"	3/4" - 1"	2	H63932	
5/32"	4"	1" - 1/4"	1	H63942	

QUICK HITCH SPECIFICATIONS

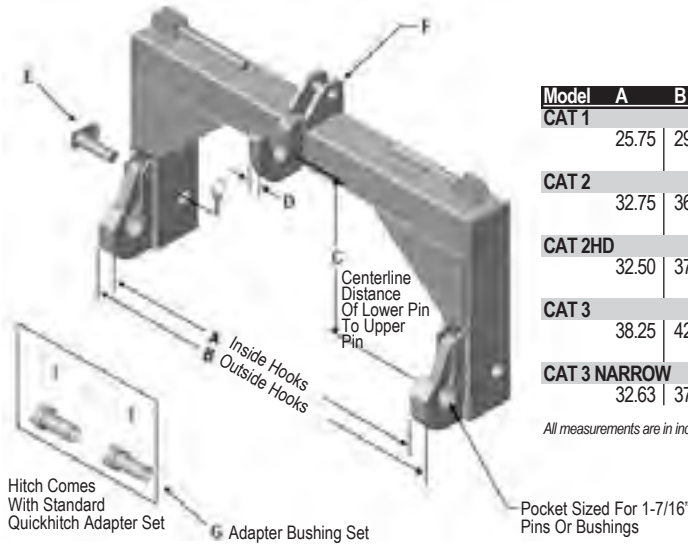

Model	A	B	C	D	E	F	G	Weight	Order No	Price
CAT 1	25.75	29.50	14.50-17.25	1.25	7/8	3/4	7/8" to 1-7/16"	76 lbs.	505933	
CAT 2	32.75	36.25	14.88	1.25	1-1/8	1	1-1/8" to 1-7/16"	134 lbs.	882878	
CAT 2HD	32.50	37.75	14.88	1.25	1-1/8	1-1/4	1-1/8" to 1-7/16"	160 lbs.	A 902957	
CAT 3	38.25	42.75	18.88	1.25	1-7/16	1-1/4	Not Required	182 lbs.	A 902965	
CAT 3 NARROW	32.63	37.00	19.00	1.25	1-7/16	1-1/4	Not Required	176 lbs.	A 903013	

All measurements are in inches unless otherwise noted.

DRAWBAR LOCKS AND HOOKS



DRAWBAR LOCK- Use this to keep the horizontal drawbar on your three-point hitch from rotating. Fits Category 1 only. Keeps drawbar stationary, making hitching easier.

Order No. Price
A 586503

FORGED LIFT ARMS



• Fits Ford 600, 700, 800, 900, 2000, 4000 4-cylinder; 2000, 3000, 3610 3-cylinder
• Replaces DONN555C, DONN555D.

Side Order No. Price
Left Hand A 825852
Right Hand A 825853

FORGED TOP LINKS

All Top Links Include Handles.

A 890657

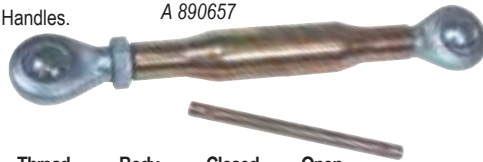

Cat.	Pin Hole Size	Thread Diam.	Body Length	Closed Length	Open Length	Order	Price
0	5/8"	3/4" NC	7-1/2"	11"	16"	A 890657	
1	3/4"	1-1/8" NC	13-1/4"	18"	28"	L35-0189	
1	3/4"	1-1/8" NC	17	20-1/2"	29"	A 825836	
1	3/4"	1-1/8" NC	20"	25"	35"	L35-0176	
1	3/4"	1-1/8" NC	24"	29"	39"	L35-0177	
1 & 2	3/4", 1"	1-1/8" NC	16"	21"	32"	L35-0178	
2	1"	1-1/4" NC	16"	23"	32"	L35-0132	
2	1"	1-1/8" NC	20"	24"	36"	A 825847	
2	1"	1-1/8" NC	24"	29"	41"	L35-0182	
2	1"	1-1/4" NC	20"	27"	37"	L35-0183	

DRAWBARS

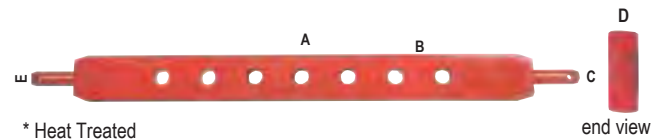

* Heat Treated

Cat.	Holes	A	B	C	D	E	Order No.	Price
1	11	26"	3/4"	7/8"	1"	2-1/2"	A 882837	
1	11	26"	3/4"	7/8"	1-1/8"	2-1/2"	B06-0080*	
2	11	26"	3/4"	1-1/8"	1-1/4"	3"	A 882852	
2	13	32"	3/4"	1-1/8"	1-1/4"	3"	B06-0100*	

IH OFFSET TONGS FOR 32" CAT. 2



Description Order Price
Left Hand A 900092
Right Hand A 900100

TOP LINK PINS



Pin Cat.	Usable Diam.	Overall Length	Length	Order No.	Price
0	5/8"	2-3/4"	4-7/16"	P34-0160	
1	3/4"	3"	4-7/16"	P34-0130	
1	3/4"	4-1/8"	5-7/16"	P34-0135	
1	3/4"	5"	6-7/16"	P34-0145	
2	1"	3-1/8"	4-3/4"	P34-0015	
2	1"	3-13/16"	5-21/64"	P34-0140	
2	1"	4-3/8"	6"	P34-0025	
2	1"	5-1/2"	7-1/4"	P34-0027	
3	1-1/4"	4-3/8"	6-1/2"	P34-0010	

STABILIZER KITS AND ACCESSORIES

Description	Application	Replaces Number	Order No.	Price
Stay Straps - Upper & Lower	Ferguson TO20, TO30, TO35, Ford 2N, 9N, 8N, NAA, 600, 700, 800, 900, Oliver 550 & all Oliver 3-pt conversions. MF 35 & 50			
	Upper Stay Strap	DS 511	A 882746	
	Lower Stay Strap	DS 512	A 882753	
Universal Stabilizer Bracket Right or Left	Ferguson TO20, TO30, TO35, MF 50, 135, 150, 165, 175, 235, 245, Ford 2N, 9N, 8N, 600, 800, 2000, 2600, 3000 & 3600	S 160	A 882720	
Universal Stabilizer Arm	Ford 2000 - 3000, 7/8" hole, 31-5/8" hole centers	H6251	A 902361	
Stabilizer Bar, Right or Left	Category "1". 31-9/16" long. Fits 8N, 2N, 8N	SA621	A 899864	
Stay Chain Assembly	Fits Category "1" pins.		A 902494	



TOPLINK & LIFT ARM BUSHINGS

Type	Fits Pin Cat.	Fits Arm Cat.	O.D.	I.D.	Length	Order Number	Price
Lift Arm	0	1	7/8"	5/8"	1-3/8"	B82-0828B	
Lift Arm	1	2	1-1/8"	7/8"	1-3/8"	B82-0290B	
Lift Arm	1	2	1-1/8"	7/8"	1-3/4"	B82-0210B	
Lift Arm	2	3	1-7/16"	1-1/8"	2-3/4"	B82-0270B	
Lift Arm	2	3	1-7/16"	1-1/8"	3-1/4"	B82-0280B	
Top Link	0	1	3/4"	5/8"	1-5/8"	B82-0829B	
Top Link	1	2	1"	3/4"	2"	B82-0230B	
Top Link	2	3	1-1/4"	1"	2"	B82-0240B	

LIFT ARM DRAW PINS

Style 1 - Adjustable Shoulder

Style 2 - Fixed Shoulder



Style 3 - Roll Pin

Cat	Shoulder	Pin Diam.	Usable Length	Overall Length	Thread Diam.	Order No.	Price
0	Adj.	5/8"	1-1/4"	4"	5/8"	P34-0200	
1	Adj.	7/8"	1-5/8"	5"	7/8" NF	P34-0046	
1	Fixed	7/8"	1-3/4"	5-1/2"	7/8" NF	P34-0165	
1	Adj.	7/8"	1-3/4"	4-1/2"	5/8" NF	P34-0030	
1	Adj.	7/8"	2"	6-3/16"	7/8" NF	P34-0195	
1	Fixed	7/8"	2-1/4"	6-5/8"	7/8" NF	P34-0203	
1 to 2	Adj.	7/8" - 1-1/8"	2-1/16"	8"	1" NF	P34-0035	
1 to 2	Adj.	1-1/8"	1-3/4"	5-1/8"	7/8" NF	P34-0115	
1 to 2	Fixed	1-1/8"	2-1/4"	5-7/8"	7/8" NF	P34-0120	
2	Adj.	1-1/8"	1-3/4"	6-1/4"	1-1/8"	P34-0170	
2	Fixed	1-1/8"	2"	6-1/4"	1-1/8" NF	P34-0175	
2 to 1	Fixed	1-1/8" - 7/8"	2-1/4"	6-1/8"	1-1/8" NF	P34-0202	
2 to 3	Fixed	1-1/8"	1-7/8"	5-3/4"	1-1/8" NF	P34-0125	
3	Fixed	1-7/16"	2"	5-7/8"	1-3/8" NF	P34-0201	
2	Roll Pin	1-1/8"	4-1/8"	5-3/4"	-	P34-0291	
2	Roll Pin	1-1/8"	5"	6-3/4"	-	P34-0292	
2	Roll Pin	1-1/8"	6-1/8"	7-3/4"	-	P34-0293	
2	Roll Pin	1-1/8"	7-1/2"	9"	-	P34-0294	

TOP LINK REPAIR ENDS



TOP LINK REPAIR ENDS

Cat.	Side	Thread Length	Thread Dia.	Order No.	Price
0	Left	3-1/2"	3/4"	L35-0185	
1	Right	6"	1-1/8"	L35-0152	
1	Left	6"	1-1/8"	L35-0141	
2	Right	6-1/2"	1-1/8"	L35-0111	
2	Left	6-1/2"	1-1/8"	L35-0120	
2	Right	5-1/2"	1-1/4"	L35-0126	
2	Left	5-1/2"	1-1/4"	L35-0125	

REPLACEMENT BALLS & SOCKETS

LIFT ARM/TOP LINK REPLACEMENT BALLS



A = Pin Hole Size
B = Length Thru Bore
C = Sleeve Width



Type	Cat.	A	B	C	Order No.	Price
Lift Arm	1	7/8"	1-3/8"	2-1/4"	B05-0100B	
Top Link	1	3/4"	1-3/4"	2"	A 112219	
Lift Arm	2	1-1/8"	1-3/4"	2"	A70-0246B	
Oliver Claw Type						
Top Link	2	1"	1-3/4"	2"	A 112220	

LIFT ARM BALL SOCKETS

A = Pin Hole Size
B = Length Thru Bore
C = Sleeve Width
D = Sleeve Outside Diam.

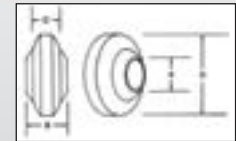

Cat.	A	B	C	D	Order No.	Price
0	5/8"	1"	3/4"	2"	A 901850	
1					B05-0216B	
1					B05-0223B	
2	1-1/8"	1-3/4"	1-7/64"	3-5/32"	B05-0240B	
2	1-1/8"	1-3/4"	1-1/4"	3-1/8"	B05-0200B	
3	1-7/16"	1-3/4"	1-13/64"	3-1/2"	B05-0242B	

TOP LINK BALL SOCKETS

A = Pin Hole Size
B = Length Thru Bore
C = Sleeve Width
D = Sleeve Outside Diam.



Cat.	A	B	C	D	Order No.	Price
2	1"	1-3/4"	7/8"	2-3/8"	B05-0214B	

LIFT ARM WELD-ON END (* Bent End)

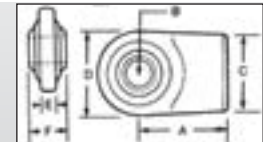

Cat.	A	B	C	D	E	F	Order No.	Price
1	2-3/4"	7/8"	2-3/8"	2-5/8"	5/8"	1-3/8"	L35-0160	
1	4"	7/8"	1-7/8"	2-5/8"	5/8"	1-3/8"	A 902742*	
2	3-1/8"	1-1/8"	2-3/4"	3-1/8"	3/4"	1-3/4"	L35-0162	
2	4"	1-1/8"	1-7/8"	3-1/8"	5/8"	1-3/4"	A 902783*	

TOP LINK WELD ON END

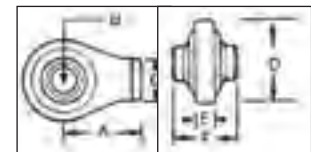

Cat.	A	B	C	D	E	F	Order No.	Price
1	2"	3/4"	1-1/8"	2-1/4"	1/2"	1-3/4"	L35-0127	
2	2-3/8"	1"	1-1/8"	2-5/8"	1/2"	2"	L35-0128	

BALE SPEARS

Bolt On Spears

Nut included. Order Sleeve Separately.



Description	Length	Capacity	Order No	Price
Threaded Standard Duty	32"	2500 lbs	BS39WN	
Threaded Standard Duty	43"	2500 lbs	BS43WN	
Threaded Standard Duty	49"	2500 lbs	BS49WN	
Threaded Heavy Duty	32"	3500 lbs	BS39WNHD	
Threaded Heavy Duty	43"	3500 lbs	BS43WNHD	
Threaded Heavy Duty	49"	3500 lbs	BS49WNHD	

Pin On Spears Order Bushing/Sleeve Separately.



Description	Length	Capacity	Order No	Price
Cross Bolt Standard Duty	43"	2500 lbs	BS43CB	
Cross Bolt Standard Duty	49"	2500 lbs	BS49CB	

Hardware

Description	Length	Order No	Price
Nut - For All Bolt On Spears Above	1.18" dia.	BSNUT	
Sleeve Standard Duty	4.72"	BSSLEEVE	
Sleeve Heavy Duty	5.71"	BSSLEEVEHD	
Bushing For Pin On	5.71"	BSSLEEVECB	



AGRICULTURAL HYDRAULIC TIE-ROD CYLINDERS

- Induction-hardened and hard-chrome-plated rods
- O-ring seals throughout with polyurethane back-ups on piston and rods
- High-tensile tie rods - Ductile base and rod clevis mountings
- Rod threaded at full diameter on 1.25" (31.75 mm) rods (clevis end only)
- Cylinder barrels honed to micro-finish
- Ports in line with pin holes on base and rod end clevis
- Double-ported base on 2" (50.8 mm) through 5" (127 mm) cylinders single port on rod end



Bore	Stroke	Retracted Length	Extended Length	Rod Dia.	Port Size	Pin Dia.	Order No.	Price
2500 PSI CYLINDERS								
2"	8"	20-1/4"	28-1/4"	1-1/16"	3/8" NPTF	1"	C95-0005	
2-1/2"	8"	20-1/4"	28-1/4"	1-1/16"	3/8" NPTF	1"	C95-0100	
3"	10"	20-1/4"	30-1/4"	1-1/4"	1/2" NPTF	1"	C95-0040	
3"	16"	26-1/4"	36-1/4"	1-1/4"	1/2" NPTF	1-1/4"	C95-0085	
3"	16"	31-1/2"	47-1/2"	1-1/4"	1/2" NPTF	1-1/4"	C95-0045	
3"	24"	34"	58"	1-1/4"	1/2" NPTF	1"	C95-0060	
3"	8"	20-1/4"	28-1/4"	1-1/4"	1/2" NPTF	1"	C95-0010	
3-1/2"	8"	20-1/4"	28-1/4"	1-1/4"	1/2" NPTF	1"	C95-0105	
4"	16"	31-1/2"	47-1/2"	2"	1/2" NPTF	1-1/4"	C95-0070	
4"	24"	34-5/8"	58-5/8"	2"	1/2" NPTF	1-1/4"	C95-0080	
5"	8"	20-1/4"	28-1/4"	1-1/4"	1/2" NPTF	1"	C95-0020	
5"	8"	20-1/4"	28-1/4"	1-1/2"	1/2" NPTF	1"	C95-0065	
3000 PSI CYLINDERS								
2"	8"	20-1/4"	28-1/4"	1-1/16"	9/16"-18 NPTF	1"	C95-0110	
2-1/2"	8"	20-1/4"	28-1/4"	1-1/4"	9/16"-18 NPTF	1"	C95-0115	
3"	8"	20-1/4"	28-1/4"	1-1/4"	3/4" - 16 NPTF	1"	C95-0120	
3-1/2"	8"	20-1/4"	28-1/4"	1-1/4"	3/4" - 16 NPTF	1"	C95-0125	
4"	8"	20-1/4"	28-1/4"	1-1/4"	3/4" NPTF	1"	C95-0130	

HERSCHEL HYDRAULIC TIE-ROD CYLINDERS

- Chromed, polished and individually heat-treated shaft provides extended cylinder life.
- All cylinders are 100% hydraulically tested up to two times working pressure.
- Working pressure **2500 psi**.



Bore	Stroke	Retracted Length	Extended Length	Rod Dia.	Port Size	Pin Dia.	Order No.	Price
2"	8"	20-1/4"	28-1/4"	1-1/8"	3/8"	1"	C95-2008	
2"	10"						C95-2010	
2-1/2"	8"	20-1/4"	28-1/4"	1-1/8"	3/8"	1"	C95-2508	
3"	8"	20-1/4"	28-1/4"	1-1/4"	1/2"	1"	C95-3008	
3"	10"	20-1/4"	30-1/4"	1-1/4"	1/2"	1"	C95-3010	
3"	16"	31-1/2"	47-1/2"	1-1/2"	1/2"	1-1/4"	C95-3016	
3.5"	8"	20-1/4"	28-1/4"	1-1/4"	1/2"	1"	C95-3508	
4"	8"	20-1/4"	28-1/4"	1-1/4"	1/2"	1"	C95-4008	
4"	16"	31-1/2"	47-1/2"	1-3/4"	1/2"	1"	C95-4016	

MAXIM HYDRAULIC TIE-ROD CYLINDERS

Hard Chrome Plated Rod. Ductile Iron Piston & Gland. SAE O-Ring Ports. High Strength Clevis Mounting. **3000 PSI** Working Pressure



Bore	Stroke ASAE	Retracted Length	Extended Length	Rod Dia.	SAE Port Size	Pin Dia.	Order No.	Price
2"	8"	20.25"	28.25"	1-1/8"	8	1"	C95-0305	
2-1/2"	8"	20.25"	28.25"	1-1/8"	8	1"	C95-0310	
3"	8"	20.25"	28.25"	1-1/4"	8	1"	C95-0315	
3-1/2"	8"	20.25"	28.25"	1-1/2"	8	1"	C95-0320	
4"	8"	20.25"	28.25"	1-1/2"	8	1"	C95-0325	

HYDRAULIC HOSE ASSEMBLIES



- Male fittings on both ends.
- Neoprene cover is oil and weather resistant.

PSI Ratings	
1/4"	2500 PSI
3/8"	4000 PSI
1/2"	3500 PSI

Length	1/4" Hose Assembly		3/8" Hose Assembly		1/2" Hose Assembly	
	Order No.	Price	Order No.	Price	Order No.	Price
12"	A 1021005		A 1020502		A 1020650	
18"	A 1021013				A 1020668	
24"	A 1021021		A 523282		A 523381	
30"	A 1021039				H58-0115	
3'	A 1021047		A 5233290		A 523399	
4'	A 1021054		A 523308		A 523407	
5'	A 1021062		A 523316		A 523415	
6'			A 523324		H58-0135	
7'			A 523332		A 523431	
8'			A 523340		A 523449	
9'					A 523456	
10'			A 523365		A 523464	
12'					A 523472	
13'					A 1020684	
15'					A 1020692	

HYDRAULIC ACCESSORIES

HYDRAULIC PRESSURE GAUGE



Designed for use on machines and systems of all kinds. 2-1/2" diameter. Stainless case, bronze internals. 1/2" mounting threads. Serves well as a master check gauge to check pump and valve output in service work. Pressure range; 0 - 5000 lbs.

Type	Order No.	Price
Dry	A 561365	



A 561340

UNIVERSAL BREATHER FILTERS

Used to convert double-acting cylinders to single acting. Ideal for breather on pumps.

Description	Order No.	Price
3/8" pipe thread	A 562579	
1/2" pipe thread	A 561340	

SMALL BREATHER

Plug-type breather for converting double-action cylinder to single action. A low cost, non-reusable filter.

Description	Order No.	Price
3/8" NPT pipe thread	A 1929819	
1/2" NPT pipe thread	A 738880	

CLEVIS PIN



O.D.	Usable Length	Order No.	Price
1"	3-1/4"	A 731034	
1"	3-1/2"	A 731032	

REUSABLE HOSE ENDS

Aluminum bolt-on type.



Description	Order No.	Price
3/8" hose ID	A 573980	
1/2" hose ID	A 574129	

REUSABLE HOSE SPLICES

Two pair high tensile aluminum clamps.



Description	Order No.	Price
3/8" ID hose	A 574004	
1/2" ID hose	A 574160	



DEPTH CONTROL COLLAR KITS

Collars are split with a spring band that clamps collar on shaft. Can be used in any combination to obtain the required depth control. Easy to use, just snap on and off any cylinder. Complete with spring clamps.

Shaft Size	Depth Collars	Order No.	Price
1-1/8", 1-1/4"	3/4", 1", 1-1/2"	A 153312	
1-3/4", 1-7/8", 2"	1", 1-1/2", 2", 4"	A 153314	

ADJUSTABLE GLAND NUT WRENCHES



Description	Order No.	Price
Small	900570	
Large	900580	

BULK HYDRAULIC HOSE

Made In The USA

Compatible with Parker, Dayco and Gates fittings.

Not compatible with Weatherhead

- Oil and Weather Resistant
- -40° F TO +212° F Temperature Range

Firescreen II Formerly Farmex II Type at 100R16

- 2 Wire Equivalent

ID	Feet Per Reel	Operating Pressure	Burst Pressure	Order Number	Price
1/4"	300 FT.	5000 PSI	20,000 PSI	H58-0800	
3/8"	250 FT.	4000 PSI	16,000 PSI	H58-0802	
1/2"	250 FT.	3500 PSI	14,000 PSI	H58-0804	
3/4"	250 FT.	2250 PSI	9,000 PSI	H58-0806	



Dayco Type at 100R2

- 2 High Tensile Wire Braids

ID	Feet Per Reel	Operating Pressure	Burst Pressure	Order Number	Price
1/4"	300 FT.	5000 PSI	20,000 PSI	H58-0710	
3/8"	300 FT.	4000 PSI	16,000 PSI	H58-0712	
1/2"	250 FT.	3500 PSI	14,000 PSI	H58-0714	
3/4"	225 FT.	2250 PSI	9,000 PSI	H58-0716	
1"	100 FT.	2000 PSI	8,000 PSI	H58-0718	

FLUSH-FACE QUICK COUPLINGS FOR SKID STEERS AND ATTACHMENTS

- Pioneer Brand
- USA Made



Order Number	Description	Thread Size	Replaces	Price
F34-0301	Female O-Ring Boss	7/8-14 UNF	FEM-501-10FO-NL	
F34-0302	Female O-Ring Boss	7/8-14 UNF	FEM-502-10FO	
F34-0303	Female O-Ring Boss	1-1/16-12 UNF	FEM-501-12FO-NL	
F34-0304	Female O-Ring Boss	1-1/16-12 UNF	FEM-502-12FO	
F34-0305	Female Pipe	1/2-14 NPSF	FEM-501-8FP-NL	
F34-0306	Female Pipe	1/2-14 NPSF	FEM-502-8FP	

PIONEER COMPLETE COUPLERS



C95-0025



C59-0050



Replaces No.	Body Size	Replaces Male	Thread Size	Replaces Female	Thread Size	Order No.	Price
4000-3	3/8"	4010-3	3/8"-18 NPTF	4050-3	3/8"-18NPTF	C59-0020	
4000-4	1/2"	8010-4	1/2"-14 NPTF	4050-4	1/2"-14NPTF	C59-0025	
4000-4P	1/2"	8010-4P	1/2"-14 NPTF	4050-4P	1/2"-14NPTF	C59-0043*	
4000-5	1/2"	8010-5	3/4"-14 NPTF	4050-5	3/4"-14NPTF	C59-0026	
4000-15	1/2"	8010-15	3/4"-16 ORB	4050-15	3/4"-16 ORB	C59-0028	
4200-4	1/2"	8010-4	1/2"-14 NPTF	4250-4**	1/2"-14NPTF	C59-0030	
4200-4P	1/2"	8010-4P	1/2"-14 NPTF	4250-4P**	1/2"-14NPTF	C59-0045*	
8200-4	1/2"	8010-4	1/2"-14 NPTF	8250-4***	1/2"-14NPTF	C59-0050	

* Indicates Poppet Style which prevents uncoupled leakage.

** 4200 Series feature double acting sleeve for one handed operation when coupler is clamp or bulkhead mounted.

*** 8200 Series feature above plus unique valve design that permits connection while either or both coupler and nipple are under pressure.

PIONEER ISO COUPLERS

FEMALE BODIES



Body Size	Replaces	Thread Size	Overall Length	Wrench Flats	Largest Diameter	Order No.	Price
1/4"	4050-2	1/4"-18 NPTF	1.94"	.75"	1.08"	F34-0157	
3/8"	4050-3	3/8"-18 NPTF	2.31"	.94"	1.33"	F34-0158	
1/2"	4050-4	1/2"-14 NPTF	2.60"	1.06"	1.52"	F34-0159	
1/2"	4050-4P	1/2"-14 NPTF	2.60"	1.06"	1.52"	F34-0207*	
1/2"	4250-4	1/2"-14 NPTF	2.68"	.94"	1.50"	F34-0165*	
1/2"	4250-4P	1/2"-14 NPTF	2.68"	.94"	1.50"	F34-0208*	
1/2"	8250-4	1/2"-14 NPTF	3.29"	.87"	1.50"	F34-0230	

* Indicates Poppet Style

Lever Style Coupler - Connect Under Pressure

1/2"	9250-4	1/2"-14 NPTF	5.37"	1.13"	1.50"	F34-0055
------	--------	--------------	-------	-------	-------	----------

MALE TIPS



F34-0201



F34-0195



F34-0203



F34-0196

Body Size	Replaces	Thread Size	Overall Length	Exposed Length	Hex Size	Largest Diameter	Order No.	Price
1/4"	4010-2P	1/4"-18 NPTF	1.31"	.63"	.75"	.87"	F34-0201*	
3/8"	4010-3	3/8"-18 NPTF	1.60"	.80"	.94"	1.08"	F34-0155	
1/2"	8010-4	1/2"-14 NPTF	1.95"	1.09"	1.06"	1.23"	F34-0195	
1/2"	8010-4P	1/2"-14 NPTF	1.95"	1.09"	1.06"	1.23"	F34-0203*	
1/2"	8010-15	3/4"-16 ORB	2.06"	1.20"	1.06"	1.23"	F34-0196	
1/2"	8010-15P	3/4"-16 ORB	2.06"	1.20"	1.06"	1.23"	F34-0204*	
3/4"	4110-5	3/4"-14 NPTF	1.81"	1.23"	1.31"	1.52"	F34-0163	

* Indicates Poppet Style

STRAIGHT ADAPTERS WITH SWIVEL

Male Pipe to Female Pipe Swivel Adapter



A 1020809

Male x Female	Order No.	Price
1/4" x 1/4"	A 1020809	
1/4" x 3/8"	A 1020817	
3/8" x 1/4"	A 1020825	
3/8" x 3/8"	A 523084	
3/8" x 1/2"	A 1020544	
1/2" x 1/2"	A 523100	
1/2" x 3/8"	A 1020536	
3/4" x 3/4"	A 1020734	

Female Pipe to Female JIC Swivel Adapter



A 1020957

Pipe x JIC	Order No.	Price
3/8" x 9/16"-18	A 1020932	
1/2" x 3/4"-16	A 1020940	
1/2" x 7/8"-14	A 1020957	

Female Pipe to Female Pipe Swivel Adapter



A 1020833

Fem. x Fem	Order No.	Price
1/4" x 1/4"	A 1020833	
3/8" x 3/8"	A 523118	
1/2" x 1/2"	A 523126	

SAE Male with O-ring to Female Pipe



A 1020601

Male x Female	Order No.	Price
3/4"-16 x 3/8"	1020601	
3/4"-16 x 1/2"	1020619	
7/8"-14 x 1/2"	1020510	

STRAIGHT ADAPTERS (NOT SWIVEL)

Female Pipe to Male JIC



A 1020965

Female x Male	Order No.	Price
3/8" x 9/16"-18	A 1020965	
3/8" x 3/4"-16	A 1020973	
1/2" x 3/4"-16	A 1020981	
1/2" x 7/8"-14	A 1020999	

Female Pipe to SAE Male with O-Ring



A 1020627

Female x Male	Order No.	Price
1/2" x 3/4"-16	A 1020627	
1/2" x 7/8"-14	A 1020635	

HYDRAULIC ACCESSORIES



A 1006337



A 1006329

Dust Cap & Plug

Used to eliminate contamination of the hydraulic system and improve service life of couplers.

Description	Order No.	Price
1/2" Dust Cap	A 1006337	
1/2" Dust Plug	A 1006329	



A 1006014

Break-Away Clamps

Designed to be used with all couplings that have 1-1/2" diameter sleeve.

Description	Order No.	Price
Single Breakaway Clamp (5001-4)	A 1005990	
Double Breakaway Clamp (5006-4)	A 1006014	

SWIVEL TEE ADAPTERS



A 1020924

SWIVEL - TEE ADAPTERS

Side A	Side B	Side C	Order No.	Price
3/8" Male	3/8" Fem.	3/8" Fem.	A 1020924	
1/2" Male	1/2" Fem.	1/2" Fem.	A 1020585	

ANGLED ADAPTERS WITH SWIVELS



A 1020866

90° Adapter with Swivel Male Pipe to Female Pipe

Male x Female	Order No.	Price
1/4" x 1/4"	A 1020866	
3/8" x 1/4"	A 1020874	
3/8" x 3/8"	A 1929884	
1/2" x 1/2"	A 1020593	
3/4" x 1/2"	A 1021104	

ASSORTED ADAPTERS



A 523142

Description	Order No.	Price
3/4"-16 SAE Male Thread with O-ring x 1/2" Female Pipe	A 523142	
7/8"-14 SAE Male Thread with O-ring x 1/2" Female Pipe	A 1020528	

HYDRAULIC PUMPS FOR WAGNER LOADER



FOR WAGNER LOADER

13.2 gpm capacity at 2,000 rpm and 1,800 psi. Gear-type pump with pressure-loaded bearings. Base mount can be adapted to other applications. 3/4" round, keyed shaft.

Order No.	Price
A 1159714	

PTO GEAR PUMPS

Ideal for use on tractor front-end loaders, tractors imported without integral hydraulics, rotary mowers, landscaping equipment. Two-bolt installation on farm tractors of all sizes. Internal spline with thru-drive feature. High tensile cast iron end plates. Slips on tractor PTO (no gear box required).

A 531517



- 1-3/8" 6-tooth drive shaft required.
- Inlet port size: SAE 16
- Outlet port size: SAE 12
- Self-adjusting wear plates on both sides.
- Two outlet ports with plug to seal unused port.
- Roller Bearings.

Max RPM	Max PSI	HP Output	Maximum GPM at 2000 PSI	Order No.	Price
540	2250	23.8	23 gpm	A 531517	
540	2250	13.8	11.6 gpm	A 531723	

HYDRAULIC VANE PUMP FOR MODEL TB



Inlet Size: 1, Outlet Size: 3/4", Shaft Size: 3/4". No-Load starting & requires 400 rpm to complete the priming action and to pressurize vanes. Equipped w/a shaft w/ball-type bearing giving maximum support to drive shaft so that pump may be belt/chain driven.

Max RPM	Max PSI	Maximum GPM at 1200 PSI	Order No.	Price
2000	1500	12 gpm	A 531434	

HYDRAULIC ADAPTERS



Using Male Tip	Using Female Body	Order No.	Price
Pioneer ISO	John Deere Old Style	A15-0225	
International	John Deere Old Style	A15-0215	
John Deere Old Style	John Deere New Style	A15-0238	
International	John Deere New Style	A15-0005	
John Deere Old Style	Int. Harvester Old Style	A15-0220	
Pioneer ISO	Int. Harvester Old Style	A15-0230	
Pioneer ISO	JI Case Old Style	A15-0210	
John Deere Old Style	JI Case New Style	A15-0238	
International	JI Case New Style	A15-0005	
John Deere Old Style	Pioneer	A15-0235	
International	Pioneer	A15-0001	
JI Case Old Style	Pioneer	A15-0240	

SPECIALIZED COUPLERS

1006071



MALE TIPS

Thread Description	Size	Replaces	Order No.	Price
International "Old Style"	1/2" NPTF	5070-4	F34-0180	
John Deere "Old Style"	1/2" NPTF	5060-4	F34-0170	
John Deere "Old Style"	3/4" ORB	5060-15	F34-0175	
International "Old Style"	7/8"-14 ORB	5070-16	F34-0185	
Case/IH "New Style"	1/2" NPTF	5077-1	F34-0186	
Case "Old Style"	1/2" NPTF	5080-4	F34-0188	

1006238



FEMALE BODY

John Deere Body	1/2" NPTF	4056-4	F34-0010
-----------------	-----------	--------	----------

CHIEF HYDRAULIC MOTORS

- 1" diameter woodruff keyed cylindrical shaft.
- For light and medium duty applications.
- Dual rotation.
- 4-bolt mounting flange.
- 1/2" NPTF port.
- *Replacement for Char-Lynn "H" Series.



CU.IN.	Max Displacement	RPM	Torque	PSI	Order No.	Price
4.75	740	1140	1840		A 1263714	
5.90	590	1425	1840		A 1263722	
9.50	370	2170	1840		A 1263730	
11.60	295	2530	1625		A 1263748	
14.10	240	3185	1625		A 1263755	
19.00	190	3575	1625		A 1263763	
23.60	150	3850	1450		A 1263771	

JAW COUPLERS & INSERTS

Safe even if insert fails. Resistant to oil, dirt, sand, moisture and grease.



Torque Calculator

$$\text{Torque} = \frac{\text{HP} \times 63025}{\text{RPM}}$$

COUPLER INSERTS

Description	Order No.	Price
LO75	A 1389261	
LO90, LO95	A 1389329	
LO99, LO100	A 1389485	

Bore Size	Key Way	LO75	LO90	LO95	LO100
		Max Torque 90 Order No. Price	Max torque 144 Order No. Price	Max torque 194 Order No. Price	Max torque 417 Order No. Price
1/2"	1/8" x 1/16"	A 1389220	A 1389279	A 1389337	
5/8"	3/16" x 3/32"	A 1389238	A 1389287	A 1389345	
3/4"	3/16" x 3/32"	A 1389246		A 1389352	A 1389428
7/8"	3/16" x 3/32"	A 1389253		A 1389360	
1"	1/4" x 1/8"			A 1389378	A 1389444
1-1/8"	1/4" x 1/8"			A 1389386	A 1389451
1-1/4"	1/4" x 1/8"				A 1389469
1-3/8"	5/16" x 5/32"				A 1389477

COUPLERS & COUPLER KITS

A 1021088



NEW REUSABLE COUPLERS

Reusable couplings for any hydraulic hose which is wire reinforced. If your present nipples are worn out or hose is broken, simply cut the hose where needed to install and they can be used time after time. Cannot be used on nylon or hose which is not wire reinforced.

Description	Order No.	Price
2-wire hose 3/8"	A 1021096	
2-wire hose 1/2"	A 1021088	
1-wire hose 3/8"	A 1020478	



LEVER COUPLER BREAKAWAY KIT

Permits connection even when the tractor and implement lines are both pressurized. Valves close automatically in case of breakaway. Spring-loaded dust covers keep couplers clean.

O-Ring Boss	Order No.	Price
1/2" NPTF	C41-0065	
7/8 - 14	C41-0070	

Order male tip no. 119453 for extra male tips.



A 1006170

QUICK DISCONNECT COUPLING KITS

By turning the rugged, color coded lever to "Open" you lock open the valves in both the female body and the male tip, they are unaffected by rapid variations in fluid flow. Permits connection when both the tractor line and the implement line is pressurized. Eliminates spraying and minimizes spillage of fluid. Close automatically upon breakaway. Female body.

- 3000 PSIG Rated Pressure
- 1/2" Body Size
- 1-3/8" Across Flats
- 1-1/2" Sleeve Diameter

O-Ring Boss	Order No.	Price
1/2" NPTF Left	A 1006170	
1/2" NPTF Right	A 1006188	

HYDRAULIC MULTIPLIERS



HYDRAULIC MULTIPLIERS WITH COMMAND CONTROLLER

- Universal- Fits all makes of tractors other hydraulic equipment.
- Includes 1 manifold, 2 cartridges, 2 coils, 2 ISO Male Tips, 2 Eccentric Fittings, 4 ISO Female Quick Couplers, Command Control with 12' Wiring Harness.
- Command Control - Circuit one is normally live. Circuit two is activated only when control button is depressed. When the button is released, power automatically returns to circuit one.

Description	Order No.	Price
2-Circuit Multiplier	A 532739	

FLEX WING MOWERS



BUSH HOG® MODEL NO.: 2415, 2515, 2615, 2720 & 3615

NORTH AMERICAN

Tractor Yoke	Clamp Yoke	Series	Order No	Price
1 3/8" x 6 Spl.	1 3/4" x 20 Spl.	55R	14515555	
1 3/8" x 21 Spl.	1 3/4" x 20 Spl.	55R	14615555	
1 3/4" x 20 Spl.	1 3/4" x 20 Spl.	55R	14715555	

OVERALL COMPRESSED LENGTH - 55"

RHINO® MODEL NO.: SR-15, SE-15

NORTH AMERICAN

Tractor Yoke	Clamp Yoke	Series	Order No	Price
1 3/8" x 6 Spl.	1 3/4" x 20 Spl.	55R	14505551	
1 3/8" x 21 Spl.	1 3/4" x 20 Spl.	55R	14605551	
1 3/4" x 20 Spl.	1 3/4" x 20 Spl.	55R	14705551	

METRIC

1 3/8" x 6 Spl.	1 3/4" x 20 Spl.	W/S 2580	14507951	
1 3/8" x 21 Spl.	1 3/4" x 20 Spl.	W/S 2580	14607951	
1 3/4" x 20 Spl.	1 3/4" x 20 Spl.	W/S 2580	14707951	

OVERALL COMPRESSED LENGTH - 51"

DEERE® MODEL NO.: 1517, 1518, 2018

NORTH AMERICAN

Tractor Yoke	Clamp Yoke	Series	Order No	Price
1 3/8" x 6 Spl.	1 3/4" x 20 Spl.	55R	14515555	
1 3/8" x 21 Spl.	1 3/4" x 20 Spl.	55R	14615555	
1 3/4" x 20 Spl.	1 3/4" x 20 Spl.	55R	14715555	

OVERALL COMPRESSED LENGTH - 55"

ROUND BALERS SERIES 35R



DEERE® MODEL NO.: 466, 467, 566, 567

Clutch Yoke: 1-3/8" x 6 Spl.

NORTH AMERICAN

Model #	Tractor Yoke	Friction Clutch	RPM	Order No	Price
466 / 467	1 3/8" x 6 Spl.	18,000 in•lb (9")	540	H14503500	
566 / 567	1 3/8" x 21 Spl.	10,000 in•lb (9")	1000	H14603500	

OVERALL COMPRESSED LENGTH - 58"

GEHL DELUXE MODEL NO.: 2880

NORTH AMERICAN

Tractor Yoke	Clutch Yoke	Friction Clutch	Order No	Price
1 3/8" x 6 Spl.	1 3/8" x 21 Spl.	15,000 in•lb (7")	H14503501	

OVERALL COMPRESSED LENGTH - 67"

PEANUT HARVESTERS

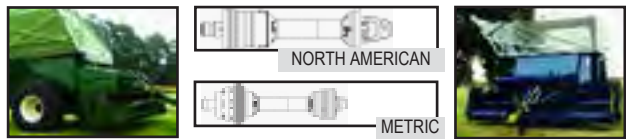

NORTH AMERICAN

Tractor Yoke	Clamp Yoke	Series	Order No	Price
1 3/8" x 21 Spl.	1 3/8" x 21 Spl. Clamp	55R	H14625555	
1 3/8" x 21 Spl.	1 3/8" x 21 Spl. w/Pinhole	55R	H14635555	
1 3/4" x 20 Spl.	1 3/8" x 21 Spl. Clamp	55R	H14725555	
1 3/4" x 20 Spl.	1 3/8" x 21 Spl. w/Pinhole	55R	H14735555	

METRIC

1 3/8" x 21 Spl.	1 3/8" x 21 Spl. Clamp	W/S 2580	H14627955	
1 3/8" x 21 Spl.	1 3/8" x 21 Spl. w/Pinhole	W/S 2580	H14637955	
1 3/4" x 20 Spl.	1 3/8" x 21 Spl. Clamp	W/S 2580	H14727955	
1 3/4" x 20 Spl.	1 3/8" x 21 Spl. w/Pinhole	W/S 2580	H14737955	

OVERALL COMPRESSED LENGTH - 55"

NON-CV

Tractor Yoke	Implement Yoke	OAL compressed	Series	Order No	Price
1 3/4" x 20	1 3/8" x 21 Spl.	55"	W/S 2500	H14007955	

Spl. QD (Star Tubing)

COMBINE HEADERS - METRIC W/S 2400 SERIES

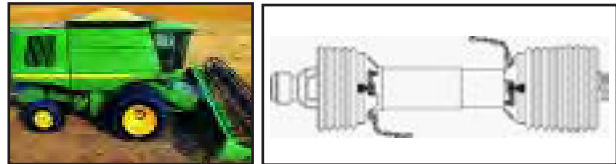

CASE IH COMBINE USING DEERE HEADER NON-CV

Combine Yoke	Header Yoke	OAL Compressed	Order No	Price
1-1/8" Hex SSL	1-1/8" Hex Clamp	33"	H14007633	

DEERE HEADERS USING TWO DRIVELINE PER HEADER NON-CV

Combine Yoke	Header Yoke	OAL Compressed	Order No	Price
1-3/8" x 21 Spl.	1-1/8" Hex Clamp	35"	H14007635	

ALL PURPOSE

ORDER NO.	TRACTOR YOKE	IMPLEMENT YOKE	OAL COMPRESSED	SERIES	Price
H14006137	1 3/8" x 6 Spl. QD	1 3/8" x 6 Spl. QD	37"	BYPY 1	
H14006247	1 3/8" x 6 Spl. QD	1 3/8" x 6 Spl. QD	47"	BYPY 2	
H14006438	1 3/8" x 6 Spl. QD	1 3/8" x 6 Spl. QD	38"	BYPY 4	
14006448	1 3/8" x 6 Spl. QD	1 3/8" x 6 Spl. QD	48"	BYPY 4	
H14006455	1 3/8" x 6 Spl. QD	1 3/8" x 6 Spl. QD	55"	BYPY 4	
H14006543	1 3/8" x 6 Spl. QD	1 3/8" x 6 Spl. QD	43"	BYPY 5	
H14006555	1 3/8" x 6 Spl. QD	1 3/8" x 6 Spl. QD	55"	BYPY 5	
H14006644	1 3/8" x 6 Spl. QD	1 3/8" x 6 Spl. QD	44"	BYPY 6	
H14006655	1 3/8" x 6 Spl. QD	1 3/8" x 6 Spl. QD	55"	BYPY 6	
14006657	1 3/8" x 6 Spl. QD	1 3/8" x 6 Spl. QD	57"	BYPY 6	
H14006846	1 3/8" x 6 Spl. QD	1 3/8" x 6 Spl. QD	46"	BYPY 8	
14006857	1 3/8" x 6 Spl. QD	1 3/8" x 6 Spl. QD	57"	BYPY 8	
H14016542	1 3/8" x 6 Spl. QD	1 3/8" x 6 Spl. QD	42"	BYPY 5	
H14016666	1 3/8" x 21 Spl. QD	1 3/8" Rd. w/Pinhole	66"	BYPY 6	
H14066644	1 3/8" x 21 Spl. QD	1 3/8" x 21 Spl. QD	44"	BYPY 6	
H14066846	1 3/8" x 21 Spl. QD	1 3/8" x 21 Spl. QD	46"	BYPY 8	
H14107155	1 3/8" x 6 Spl. QD	30-mm Friction Clutch	55"	W/S 2100	
H14217939	1 3/8" x 21 Spl. QD	1 3/8" x 21 Spl. w/Clamp Yoke	39"	W/S 2500	

CATFISH POND DRIVELINE

ORDER NO.	TRACTOR YOKE	IMPLEMENT YOKE	OAL COMPRESSED	SERIES	Price
14006424	1 3/8" x 6 Spl. QD	1 1/2" Rd.	48"	BYPY 4	
14006524	1 3/8" x 6 Spl. QD	1 1/2" Rd.	48"	BYPY 5	
14006624	1 3/8" x 6 Spl. QD	1 1/2" Rd.	48"	BYPY 6	
14016524	1 3/8" x 21 Spl. QD	1 1/2" Rd.	48"	BYPY 5	
14016624	1 3/8" x 21 Spl. QD	1 1/2" Rd.	48"	BYPY 6	

DISC MOWER

ORDER NO.	TRACTOR YOKE	IMPLEMENT YOKE	OAL COMPRESSED	SERIES	Price
14306639	1 3/8" x 6 Spl. QD	1 3/8" x 6 Spl. w/Overrunning Clutch	39"	BYPY 6	
14307645	1 3/8" x 6 Spl. QD	1 3/8" x 6 Spl. w/Overrunning Clutch	45"	W/S 2400	

FERTILIZER SPREADER

ORDER NO.	TRACTOR YOKE	IMPLEMENT YOKE	OAL COMPRESSED	SERIES	Price
14006127	1 3/8" x 6 Spl. QD	1 3/8" x 6 Spl. QD	27"	BYPY 1	
14006135	1 3/8" x 6 Spl. QD	1 3/8" x 6 Spl. QD	35"	BYPY 1	

FINISHING MOWER

ORDER NO.	TRACTOR YOKE	IMPLEMENT YOKE	OAL COMPRESSED	SERIES	Price
14006340	1 3/8" x 6 Spl. QD	1 3/8" x 6 Spl. QD	40"	BYPY 3	
14006446	1 3/8" x 6 Spl. QD	1 3/8" x 6 Spl. QD	46"	BYPY 4	
14006637	1 3/8" x 6 Spl. QD	1 3/8" x 6 Spl. QD	37"	BYPY 6	

HAMMER MILL

ORDER NO.	TRACTOR YOKE	IMPLEMENT YOKE	OAL COMPRESSED	SERIES	Price
H14006628	1 3/8" x 6 Spl. QD	1 3/4" Rd.	48"	BYPY 6	
H14006748	1 3/8" x 6 Spl. QD	1 3/4" Rd.	48"	BYPY 7	

HAY TEDDER

ORDER NO.	TRACTOR YOKE	IMPLEMENT YOKE	OAL COMPRESSED	TYPE	SERIES	Price
14206252*	1 3/8" x 6 Spl. QD	1 3/8" x 6 Spl. w/Ratchet Clutch	52"	2-Rotor	BYPY 2	
14206454**	1 3/8" x 6 Spl. QD	1 3/8" x 6 Spl. w/Ratchet Clutch	54"	4-Rotor	BYPY 4	
H14207939	1 3/4" x 20 Spl. QD	1 3/8" x 21 Spl. w/Ratchet Clutch	39"	--	W/S 2500	

*Light Duty **Heavy Duty

PEANUT HARVESTER (NON-CV)

ORDER NO.	TRACTOR YOKE	IMPLEMENT YOKE	OAL COMPRESSED	SERIES	Price
H14007955 (Star Tubing)	1 3/4" x 20 Spl. QD	1 3/8" x 21 Spl. w/Pinhole	55"	W/S 2500	

POST HOLE DIGGER

ORDER NO.	TRACTOR YOKE	IMPLEMENT YOKE	OAL COMPRESSED	SERIES	Price
14006252	1 3/8" x 6 Spl. QD	1 1/4" Rd. w/Pinhole	52"	BYPY 2 (Light Duty)	
14006453	1 3/8" x 6 Spl. QD	1 1/4" Rd. w/Pinhole	53"	BYPY 4 (Heavy Duty)	

ROTARY CUTTER

ORDER NO.	TRACTOR YOKE	IMPLEMENT YOKE	OAL COMPRESSED	APPLICATION	SERIES	Price
H14006251	1 3/8" x 6 Spl. QD	1 3/8" Rd. w/Pinhole	51"	Pull (Towed)	BYPY 2	
14006432	1 3/8" x 6 Spl. QD	1 3/8" Rd. w/Pinhole	32"	4 ft. Lift (3-Pt.Hitch)	BYPY 4	
14006436	1 3/8" x 6 Spl. QD	1 3/8" Rd. w/Pinhole	36"	5 ft. Lift (3-Pt.Hitch)	BYPY 4	
14006442	1 3/8" x 6 Spl. QD	1 3/8" Rd. w/Pinhole	42"	6 ft. Lift (3-Pt.Hitch)	BYPY 4	
14006451	1 3/8" x 6 Spl. QD	1 3/8" Rd. w/Pinhole	51"	Pull (Towed)	BYPY 4	
14006542	1 3/8" x 6 Spl. QD	1 3/8" Rd. w/Pinhole	42"	6 ft. Lift (3-Pt.Hitch)	BYPY 5	
14006546	1 3/8" x 6 Spl. QD	1 3/8" x 6 Spl. QD	46"	6 ft. Lift (3-Pt.Hitch)	BYPY 5	
H14006551	1 3/8" x 6 Spl. QD	1 3/8" Rd. w/Pinhole	51"	6 ft. Lift (3-Pt.Hitch)	BYPY 5	
14006652	1 3/8" x 6 Spl. QD	1 3/8" Rd. w/Pinhole	52"	7 ft. Lift (3-Pt.Hitch)	BYPY 6	

ROTARY CUTTER/TILLER

ORDER NO.	TRACTOR YOKE	IMPLEMENT YOKE	OAL COMPRESSED	APPLICATION	SERIES	Price
H14106233	1 3/8" x 6 Spl. QD	1 3/8" x 6 Spl. w/Fric. Clutch	33"	Pull (Towed)	BYPY 2	
H14106436	1 3/8" x 6 Spl. QD	1 3/8" x 6 Spl. w/Fric. Clutch	36"	Pull (Towed)	BYPY 4	
14106438	1 3/8" x 6 Spl. QD	1 3/8" x 6 Spl. w/Fric. Clutch	38"	Pull (Towed)	BYPY 4	
14106546	1 3/8" x 6 Spl. QD	1 3/8" x 6 Spl. w/Fric. Clutch	46"	Pull (Towed)	BYPY 5	
14106654	1 3/8" x 6 Spl. QD	1 3/8" x 6 Spl. w/Fric. Clutch	54"	7 ft. Lift (3-Pt.Hitch)	BYPY 6	
H14106660	1 3/8" x 6 Spl. QD	1 3/4" x 20 Spl. w/Fric. Clutch	60"	7 ft. Lift (3-Pt.Hitch)	BYPY 6	
H14106661	1 3/4" x 20 Spl. QD	1 3/4" x 20 Spl. w/Fric. Clutch	61"	7 ft. Lift (3-Pt.Hitch)	BYPY 6	

ROLLER CHAIN

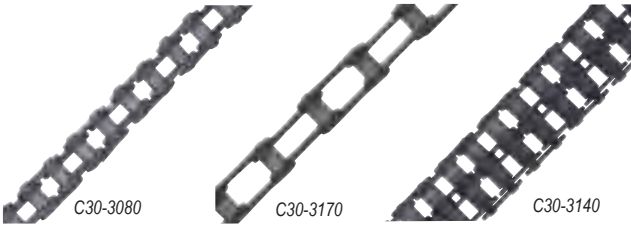

Our roller chain is made of selected hardened steel with wearing surfaces hardened for maximum chain life. Side plates are heavy to avoid stretch and rollers are held to close tolerance for better fit. Fully interchangeable with same size chain of other manufacturers and will fit all standard sprockets on combines, corn pickers and other farm machines. When ordering chain, the pitch is the distance between roller centers and the width is the distance between the inside edge of the side bar. Before ordering, check size of chain carefully by pitch and width.

Regular Roller Chain

Chain Type	Pitch	Approx. Width	Rollers Per Ft.	10' Order No.	Per Roll	50' Order No.	Per Roll	Connecting Link Order No.	Price	Half Link/Offset Link Order No.	Price
35	3/8"	3/16"	32	C30-3080				L35-0315		L35-0410	
40	1/2"	5/16"	24	C30-3085		C30-3115		L35-0325		L35-0420	
41	1/2"	1/4"	24	C30-3090		C30-3116		L35-0330		L35-0425	
50	5/8"	3/8"	19	C30-3095		C30-3120		L35-0335		L35-0430	
60	3/4"	1/2"	16	C30-3100		C30-3125		L35-0345		L35-0440	
60H	3/4"	1/2"	16	C30-3150		C30-3160		L35-0355		L35-0445	
80	1"	5/8"	12	C30-3105		C30-3124		L35-0360		L35-0455	
80H	1"	5/8"	12	C30-3155				L35-0365		L35-0460	
100	1-1/4"	3/4"	10	C30-3110				L35-0370		L35-0465	

Extended Pitch Roller Chain

2040	1"	5/16"	12	C30-3170		C30-3185		L35-0395		L35-0490	
2050	1-1/4"	3/8"	10	C30-3175		C30-3190		L35-0400		L35-0495	
2060	1-1/2"	1/2"	8	C30-3180		C30-3195		L35-0405		L35-0500	

Double Strand Roller Chain

40-2	1/2"	5/8"	24	C30-3135				L35-0328		L35-0422	
50-2	5/8"	3/4"	19	C30-3140				L35-0340		L35-0435	
60-2	3/4"	1"	16	C30-3145				L35-0350		L35-0450	

STEEL LINK CHAIN

All link chain and attachment links are American made. Our link chain is made from hot rolled strip steel and manufactured on specially designed machines which accurately and uniformly fabricate completely assembled chain. The hook of each link is formed so that the link will not become uncoupled too readily, yet when placed in coupling position may be driven apart without injury. All our chain attachments and assemblies are tested for strength and inspected for dimensional accuracy.

Type	Links Per Roll	Roll Length	Order No.	Price
#25	133	10'	C30-1006	
#32	104	10'	C30-1010	
#52	80	10'	C30-1047	
#55	74	10'	C30-1040	
#62	73	10'	C30-1046	
#67H	52	10'	C30-1170	

T-BAR CHAIN LINK

Type	Order No.	Price
Regular Link	C30-4175	
AS Right	C30-4177	
AS Left	C30-4176	

CHAIN BREAKER TOOL



CHAIN BREAKER TOOL

For No. 35 - No. 60 chain

Order No.	Price
T55-0054	

ATTACHMENT LINKS

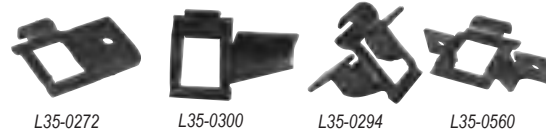

Chain Type	Link Type	Order No.	Price
55	C1	L35-0275	
55	A1 Right	L35-0135	
55	A1 Left	L35-0140	
55	HB4	L35-0191	
55	A2 Right	L35-0271	
55	A2 Left	L35-0272	
55	G27 Right	L35-0300	
55	G27 Left	L35-0295	
55	SD	L35-0294	
62	G27 Right	L35-0550	
62	G27 Left	L35-0555	
67H	AS Right	L35-0250	
67H	AS Left	L35-0255	
67XH	AS Left	L35-0265	
67XH	AS Right	L35-0260	

SPROCKETS & HUBS

Make your own sprockets and pulleys. All pieces are separate so you can get exactly what you want. Simply clamp sprocket or pulley to hub and weld. Low hydrogen electrodes are recommended for welding parts. Takes care of most repair and replacement needs.



SPROCKETS

FOR NO. 40 CHAIN 1/2" PITCH

Teeth	Use Hub Series	Order No.	Price
12	V	40V12C	
13	V	40V13C	
14	V	40V14C	
15	V	40V15C	
16	W	40W16C	
17	W	40W17C	
18	W	40W18C	
19	W	40W19C	
20	X	40X20C	
21	X	40X21C	
22	X	40X22C	
24	X	40X24C	
26	X	40X26C	
28	X	40X28C	
30	X	40X30C	
32	X	40X32C	
36	X	40X36C	
40	X	40X40C	
45	X	40X45C	
48	X	40X48C	

FOR NO. 50 CHAIN 5/8" PITCH

Teeth	Use Hub Series	Order No.	Price
10	V	50V10C	
12	W	50W12C	
13	W	50W13C	
14	W	50W14C	
15	W	50W15C	
16	W	50W16C	
17	X	50X17C	
18	X	50X18C	
19	X	50X19C	
20	X	50X20C	
21	X	50X21C	
24	X	50X24C	
26	X	50X26C	
28	X	50X28C	
30	X	50X30C	
32	X	50X32C	
36	X	50X36C	

FOR NO. 60 CHAIN 3/4" PITCH

Teeth	Use Hub Series	Order No.	Price
9	V	60V09C	
11	W	60W11C	
12	W	60W12C	
13	W	60W13C	
14	W	60W14C	
15	X	60X15C	
16	X	60X16C	
17	X	60X17C	
18	X	60X18C	
19	X	60X19C	
20	X	60X20C	
21	X	60X21C	
22	X	60X22C	
24	X	60X24C	
26	X	60X26C	
28	X	60X28C	
30	X	60X30C	

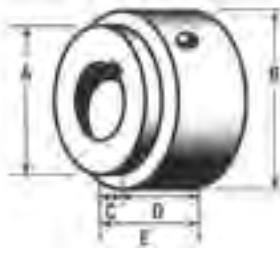

DIMENSIONS

V-Series Hubs	W-Series Hubs	X-Series Hubs
A -- 1-1/8	A -- 1-5/8	A -- 2
B -- 1-7/16	B -- 1-13/16	B -- 2-1/2
C -- 7/16	C -- 7/16	C -- 7/16
D -- 3/4	D -- 1	D -- 1
E -- 1-3/16	E -- 1-7/16	E -- 1/716



HUB with SPLINED BORE AND SET SCREW

Series	Size	Spline	Order No.	Price
W	1-1/8"	6	W1-1/8C6SP	
W	1-3/8"	6	W1-3/8C6SP	
X	1-1/8"	6	X1-1/8C6SP	
X	1-3/8"	6	X1-3/8C6SP	

HUBS

V Series round bore with Keyway & Set Screw



Bore Size	Keyway W x D	Order No.	Price
1/2"	1/8 x 1/16	V12C	
5/8"	3/16 x 3/32	V58C	
3/4"	3/16 x 3/32	V34C	
7/8"	3/16 x 3/32	V78C	

W Series round bore with Keyway & Set Screw

Bore Size	Keyway W x D	Order No.	Price
1/2"	1/8 x 1/16	W12C	
5/8"	3/16 x 3/32	W58C	
11/16"	3/16 x 3/32	W11/16C	
3/4"	3/16 x 3/32	W34C	
7/8"	3/16 x 3/32	W78C	
15/16"	1/4 x 1/8	W1516C	
1"	1/4 x 1/8	W1C	
1-1/16"	1/4 x 1/8	W1-1/16C	
1-1/8"	1/4 x 1/8	W1-1/8C	
1-3/16"	1/4 x 1/8	W1-3/16C	
1-1/4"	1/4 x 1/8	W114C	

X Series round bore with Keyway & Set Screw

Bore Size	Keyway W x D	Order No.	Price
5/8"	3/16 x 3/32	X58C	
3/4"	3/16 x 3/32	X34C	
7/8"	3/16 x 3/32	X78C	
15/16"	1/4 x 1/8	X15/16C	
1"	1/4 x 1/8	X1C	
1-1/16"	1/4 x 1/8	X1-1/16C	
1-1/8"	1/4 x 1/8	X118C	
1-3/16"	1/4 x 1/8	X1-3/16C	
1-1/4"	1/4 x 1/8	X114C	
1-3/8"	5/16 x 5/32	X138C	
1-7/16"	3/8 x 3/16	X1716C	
1-1/2"	3/8 x 3/16	X112C	

IDLER SPROCKETS



Teeth	Chain Size	Bore	Order No.	Price
17	40, 41	1/2"	S62-0010	
15	50	5/8"	S62-0040	
13	50	5/8"	S62-0030	
17	50	1/2"	S62-0803	
15	60	1/2"	S62-0807	
15	60	5/8"	S62-0806	



PULLEYS

Hub OD	V-Belt Series	Style	Order No.	Price
3-1/2"	V	A or B	V0350S	
4"	W	A or B	W0400S	
4-1/2"	W	A or B	W0450S	
5"	W	A or B	W0500S	
5-1/2"	W	A or B	W0550S	
6"	W	A or B	W0600S	
6-1/2"	W	A or B	W0650S	
7"	W	A or B	W0700S	
8"	W	A or B	W0800S	
9"	W	A or B	W0900S	

SEALED BALL BEARINGS - AEL OR RA SERIES



B15-2010D

- Prelubricated
- Spherical
- Eccentric Locking Cam
- Extended Inner Race One Side
- Individually Packaged

Order Number	Replaces Number	Fafnir Number	Series	Shaft Size	Outside Diameter	Price
B15-2009D	UEL201-008		40	1/2"	1.5748"	
B15-2010D	AEL202-010	RA010NPPB	40	5/8"	1.5748"	
B15-2012D	AEL204-012	RA012NPPB	47	3/4"	1.8504"	
B15-2014D	AEL205-014	RA014NPPB	52	7/8"	2.0472"	
B15-2016D	UEL205-015		52	.9375"	2.0472"	
B15-2100D	AEL205-100	RA100NPPB	52	1"	2.0472"	
B15-2102D	AEL206-102	RA102NPPB	62	1-1/8"	2.4409"	
B15-2203D	AEL206-104	RA103NBBP-2	62	1-1/4" (Light)	2.4409"	
B15-2104D	AEL207-104*	RA104NPPB	72	1-1/4"	2.8346"	
B15-2106D	AEL207-106	RA106NPPB	72	1-3/8"	2.8346"	
B15-2107D	AEL207-107	RA107NPPB	72	1-7/16"	2.8346"	
B15-2108D	AEL208-108	RA108NPPB	80	1-1/2"	3.1496"	
B15-2109D	UEL208-025		80	1.5625"	3.1496"	
B15-2110D	UEL209-026		85	1.625"	3.3465"	
B15-2112D	AEL209-112	RA112NPPB	85	1-3/4"	3.3464"	
B15-2114D	UEL210-030		90	1.875"	3.5433"	
B15-2115D	UEL210-031		90	1.9375"	3.5433"	
B15-2116D	UEL210-032		90	2"	3.5433"	
B15-2117D	UEL211-034		100	2.125"	3.937"	
B15-2118D	UEL211-035		100	2.1875"	3.937"	

REGREASABLE BALL BEARINGS - UEL OR G SERIES



B15-1012D

- Regreaseable
- Spherical
- Eccentric Locking Cam
- Extended Inner Race One Side
- Individually Packaged

Order Number	Replaces Number	Fafnir Number	Series	Shaft Size	Outside Diameter	Price
B15-1009D	AEL201-008		47	1/2"	1.8504"	
B15-1010D	AEL202-010		47	5/8"	1.8504"	
B15-1012D	UEL204-012D1	G1012KRRB	47	3/4"	1.8504"	
B15-1014D	UEL205-014D1	G1014KRRB	52	7/8"	2.0472"	
B15-1016D	AEL205-015		52	.93"	2.0472"	
B15-1100D	UEL205-100D1	G1100KRRB	52	1"	2.0472"	
B15-1102D	UEL206-102D1	G1102KRRB	62	1-1/8"	2.4409"	
B15-1103D	UEL206-103D1	G1103KRRB	62	1-3/16"	2.4409"	
B15-1104D	UEL206-104D1	G1103KRRB-3	62	1-1/4"	2.4409"	
B15-1203D	UEL207-104D1	G1104KRRB	72	1-1/4"	2.8346"	
B15-1106D	UEL207-106D1	G1106KRRB	72	1-3/8"	2.8346"	
B15-1108D	UEL207-107D1	G1107KRRB	72	1-7/16"	2.8346"	
B15-1108D	UEL208-108D1	G1108KRRB	80	1-1/2"	3.1496"	
B15-1109D	UEL208-109D1	G1109KRRB	80	1-9/16"	3.1496"	
B15-1110D	UEL209-110D1	G1110KRRB	85	1-5/8"	3.3465"	
B15-1112D	UEL209-112D1	G1112KRRB	85	1-3/4"	3.3465"	
B15-1114D	AEL210-030		90	1.875"	3.5433"	
B15-1115D	UEL210-115D1	G1115KRRB	90	1-15/16"	3.5433"	
B15-1116D	AEL210-032		90	2"	3.5433"	
B15-1117D	AEL211-034		100	2.125"	3.937"	
B15-1118D	AEL211-035		100	2.187"	3.937"	
B15-1119D	AEL212-036		110	2.25"	4.3307"	
B15-1120D	AEL212-038		110	2.375"	4.3307"	
B15-1121D	AEL212-039		110	2.4375"	4.3307"	
B15-1122D	AEL213-040		120	2.5"	4.7244"	
B15-1123D	AEL214-044		125	2.75"	4.9213"	

DISC BEARINGS

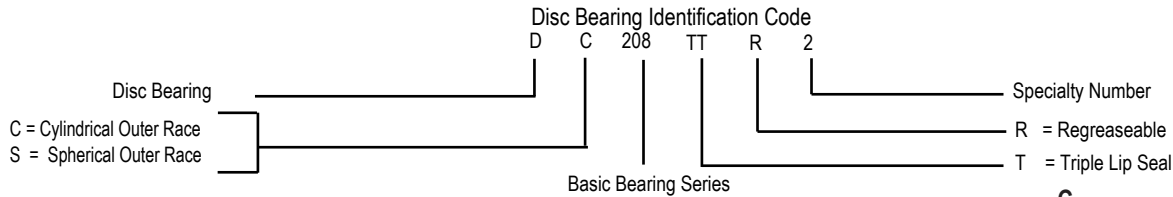

CYLINDRICAL OUTER RACE - DC SERIES

Order Number	BCA Number	Bore Size (A)	Outer Diam. (B)	Outer Race Width (C)	Inner Race Width (D)	Price
B15-3180	DC208TT5	1-1/8", SQ	3.1496"	.709	1.438	
B15-3190	DC208TT8	1-1/8", SQ	3.1496"	1.185	1.438	
B15-3184	DC211TT3	1-1/2", SQ	3.397"	1.313	1.313	
B15-3188	DC211TTR3	1-1/2", SQ	3.397"	1.313	1.313	
B15-3182	DC211TT5	1-1/2", SQ	4.000"	1.438	1.750	

SPHERICAL OUTER RACE - DS SERIES

Order Number	BCA Number	Bore Size (A)	Outer Diam. (B)	Outer Race Width (C)	Inner Race Width (D)	Price
B15-3176	DS208TT6	1", SQ	3.158"	.709	1.438	
B15-3050	DS208TT5	1-1/8", SQ	3.1496"	.709	1.438	
B15-3110	DS208TT8	1-1/8", SQ	3.1496"	1.188	1.438	
B15-3186	DS208TTR8	1-1/8", SQ	3.150"	1.188	1.438	
B15-3170	DS208TT12	1-1/8", SQ	3.4340"	1.188	1.438	
B15-3144	DS210TTR4	1-1/8", SQ	3.5433	1.188	1.188	
B15-3185	DS209TT5	1-1/4", SQ	3.347"	1.188	1.438	
B15-3125	DS209TTR5	1-1/4", SQ	3.3465"	1.188	1.438	
B15-3080	DS208TT7	1-3/16", RD	3.1496"	.709	1.188	
B15-3120	DS209TT4	1-1/2", RD	3.3465"	1.188	1.188	
B15-3124	DS209TTR4	1-1/2", RD	3.3465"	1.188	1.188	
B15-3187	DS211TTR3	1-1/2", SQ	3.397"	1.313	1.313	
B15-3150	DS211TT3	1-1/2", SQ	3.9370"	1.313	1.313	
B15-3181	DS211TT6	1-1/2", SQ	4.125"	1.438	1.750	
B15-3130	DS209TTR10	1-3/4", RD	3.3465"	.866	1.438	
B15-3178	DS209TT2	1-3/4", RD	3.347"	1.188	1.188	
B15-3183	DS210TT2	1-15/16", RD	3.543"	1.188	1.188	
B15-3142	DS210TTR2	1-15/16", RD	3.5433"	1.188	1.188	
B15-3177	DS211TTR2	2-3/16", RD	3.937"	1.313	1.313	

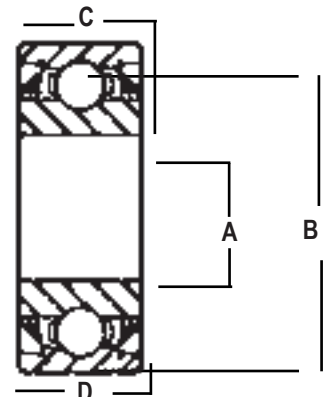

All heavy duty disc bearings feature long lasting triple lip seals.

RIVETED 4-BOLT FLANGE -- FD SERIES

Order Number	BCA Number	Bore Size	Price
B15-3010	FD209RA, ST491A	1-3/4", RD	
B15-3179	FD209RB	1-1/2", RD	



Shaft Size	BEARING INSERT		CAST IRON PILLOW BLOCKS				STAMPED STEEL FLANGES (SOLD AS PAIRS)						CAST FLANGE		
	RELUBE TYPE	PRE LUBE TYPE	HIGH CENTER		LOW CENTER		2 HOLE		3 HOLE TRIANGLE		3 HOLE ROUND		4 HOLE		
	Order No.	Price	Order No.	Price	Order No.	Price	Order No.	Price	Order No.	Price	Order No.	Price	Order No.	Price	
1/2	B15-1009D		B15-2009D		B15-5104		B15-5004		F45-2040		F45-3340		F45-3040		F45-4204
5/8	B15-1010D		B15-2010D		B15-5104		B15-5004		F45-2040		F45-3340		F45-3040		F45-4204
3/4	B15-1012D		B15-2012D		B15-5104		B15-5004		F45-2047		F45-3347		F45-3047		F45-4204
7/8	B15-1014D		B15-2014D		B15-5105		B15-5005		F45-2052		F45-3352		F45-3052		F45-4205
15/16	B15-1016D		B15-2016D		B15-5105		B15-5005		F45-2052		F45-3352		F45-3052		F45-4205
1	B15-1100D		B15-2100D		B15-5105		B15-5005		F45-2052		F45-3352		F45-3052		F45-4205
1-1/8	B15-1102D		B15-2102D		B15-5106		B15-5006		F45-2062		F45-3362		F45-3062		F45-4206
1-3/16	B15-1103D		B15-2103D		B15-5106		B15-5006		F45-2062		F45-3362		F45-3062		F45-4206
1-1/4 (LD)	B15-1104D		B15-2203D		B15-5106		B15-5006		F45-2062		F45-3362		F45-3062		F45-4206
1-1/4 (HD)	B15-1203D		B15-2104D		B15-5107		B15-5007				F45-3372		F45-3072		F45-4207
1-3/8	B15-1106D		B15-2106D		B15-5107		B15-5007				F45-3372		F45-3072		F45-4207
1-7/16	B15-1107D		B15-2107D		B15-5107		B15-5007				F45-3372		F45-3072		F45-4207
1-1/2	B15-1108D		B15-2108D		B15-5108		B15-5008								F45-4208
1-9/16	B15-1109D		B15-2109D		B15-5108		B15-5008								F45-4208
1-5/8	B15-1110D		B15-2110D		B15-5109		B15-5009								
1-3/4	B15-1112D		B15-2112D		B15-5109		B15-5009								
1-7/8	B15-1114D		B15-2114D		B15-5110		B15-5010								
1-15/16	B15-1115D		B15-2115D		B15-5110		B15-5010								
2	B15-1116D		B15-2116D		B15-5110		B15-5010								
2-1/8	B15-1117D		B15-2117D		B15-5111		B15-5011								
2-3/16	B15-1118D		B15-2118D		B15-5111		B15-5011								
2-1/4	B15-1119D				B15-5112		B15-5012								
2-3/8	B15-1120D				B15-5112		B15-5012								
2-7/16	B15-1121D				B15-5112		B15-5012								
2-1/2	B15-1122D				B15-5113		B15-5013								
2-3/4	B15-1123D				B15-5114		B15-5014								



A 668620/A 668630

ATV SPOT SPRAYERS

12V Pump with handgun. 15' EPDM hose.

Size	GPM	Order No.	Price
15 Gallon	1.0	A 668620	
15 Gallon	2.0	A 668630*	
25 Gallon	2.0	A 668635*	



A 668645

25 Gallon Boomless sprayer with 12V pump and deluxe handgun. Spray width is 22'. 3.6 gpm.

Order No	Price
A 668645	

ATV SPOT SPRAYERS WITH BOOM



A 668650

25 Gallon 2 Nozzle boom sprayer with 12V pump and deluxe handgun. Spray Width 80". 2.0 gpm.

Order No	Price
A 668650	

NEW ITEM!



3-POINT SPRAYER

40 Gallon 4-Nozzle Boom. Powder coated high strength frame. Rugged poly tank with drain. 17' EPDM hose and handgun. 2.0 GPM 12V on-demand pump. 120" coverage. Switched wire lead w/alligator clamps 10'.

Order No	Price
A 668670	

12V ON DEMAND REPLACEMENT PUMP

2.0 GPM
Order No
 A 668580



TRAILER SPRAYER

25 Gallon 2 Nozzle Boom sprayer with 12V pump and handgun. 17' EPDM hose, 13" pneumatic tires. Spray width 80". 2.0 gpm.

Order No	Price
A 668640	



LIGHT HANDGUN

Adjustable nozzle tip. Locking trigger mechanism to reduce hand fatigue.

Order No	Price
A 668555	



DELUXE HANDGUN

Adjustable nozzle brass tip. "D" style.

Order No	Price
A 668550	



SPOT SPRAY GUN

Adjustable pattern twist handle. For use with weed control, livestock spraying, fence row spraying and cleaning operations such as machinery and poultry houses.

Barrel Length	Max PSI	Port NPT Hose Barb	Max Capacity	Order Number	Price
23"	400	3/4"	2.6 gpm	A 440735	
22-1/4"	900	3/4"	3.6 gpm	A 1017458	



SPOT SPRAY GUN

400 Maximum PSI. 2.6 GPM maximum capacity.

Barrel Length	Port NPT Hose Barb	Order Number	Price
7-1/4"	1/2" female	A 490870	



2 NOZZLE BOOM KIT

7' Coverage. TF VP3 spray tips with screens. Includes boom manifold. For use on spot sprayers with 1.8 gpm or larger pumps.

Order No	Price
A 668570	



SPOT SPRAY GUN

Handle rotates to control spray. Sprays to 60 ft.

Barrel Length	Max PSI	Port NPT Hose Barb	Max Capacity	Order Number	Price
21"	400	3/4" Fem.	2.6 gpm	A 440743	

Manure spreader chains (aprons) are made of 3/16" thick carbon rail steel angles. In most cases they are heavier than original equipment.

* Items marked with * must be shipped via freight truck. Please contact us for a freight quote.



67H, 67XH



T-BAR



PINTLE

Manufacturer	Model	Type	Slats	Width	Order No.	Price
Allis Chalmers	95	67H	15	37"	1021666	
Allis Chalmers	140, 140S, 281 (early)	67H	16	51"	1021922*	
Allis Chalmers	180, 299 (early)	67H	16	51"	1021926*	
Allis Chalmers	140, 140S, 281 (late)	67H	16	51-1/2"	1021930*	
Allis Chalmers	180, 299 (late)	67H	16	51-1/2"	1021934*	
Badger	160	67H	14	51-7/8"	1021989*	
Case	T-6	67H	15	36-1/4"	1021542	
Case	75	67H	13	33-7/8"	1021591	
Case	100	67H	13	37-3/4"	1021880	
Case	105, 115, 125, 135	67H	15	43-3/8"	1021609*	
Cobey	60, 75, 100, 801, 3100	67H	15	44-1/2"	1021575*	
Farmhand	F37A, 110, 430, 438	67H	14	47-1/2"	1021625*	
Gehl	117, 180	67H	15	58-1/2"	1022706*	
Gehl	117, 180	T-Bar	15	58-1/2"	A 1023258*	
Gehl	125, 250	67H	19	58-1/2"	1022714*	
Gehl	125, 250	T-Bar	19	58-1/2"	1023241*	
Gehl	350 (uses 2 chains)	67H	20	33-3/8"	1023266*	
Gehl	350 (uses 2 chains)	T-Bar	20	33-3/8"	1023274*	
H&S	125	67H	13	46-1/2"	1021690	
H&S	180, 185, 220	T-Bar	16	51-7/8"	1023290*	
International	21, 30, 31	67H	15	37"	1021666	
International	40, 150, 155, 160	67H	19	51-1/4"	1021682*	
International	75	67H	11	36-3/4"	1023324	
International	100	S	9	33-7/8"	1021633	
International	125, 130	67H	14	47-1/2"	1021625*	
International	200H, 200T, 200F	S	15	38-1/2"	1021567	
International	530	67H	14	46-1/2"	1022698*	
International	530	T-Bar	14	46-1/2"	1023340*	
International	540	67H	15	58-1/2"	1022706*	
International	540	T-Bar	15	58-1/2"	A 1023258*	
International	550, 555	67H	18	58-1/2"	1022425*	
International	550, 555	T-Bar	18	58-1/2"	1023279*	
International	570 (uses 2 chains)	67H	16	33"	1023621*	
International	570 (uses 2 chains)	Pintle	16	33"	1023639*	
John Deere	H, L, M, K	67H	12	36-1/4"	1021526	
John Deere	N	67H	15	43-7/8"	1021534*	
John Deere	R, W	67H	15	36-1/4"	1021542	
John Deere	33	67H	15	48-7/8"	1021716*	
John Deere	33	T-Bar	15	48-7/8"	1023357*	
John Deere	34	67H	15	50-1/2"	1022045*	
John Deere	40	67H	15	50-1/2"	1021890*	
John Deere	44	67H	18	48-7/8"	1021724*	
Knight	180	67H	15	58-1/2"	1022706*	
Knight	180	T-Bar	15	58-1/2"	A 1023258*	
Knight	250, 252	67H	19	58-1/2"	1022714*	
Knight	250, 252	T-Bar	18	58-1/2"	1023241*	
Massey	18	67H	13	48-3/4"	1021617*	
Massey	110, 130	67H	12	51-7/8"	1023407*	

Manufacturer	Model	Type	Slats	Width	Order No.	Price
Massey	160	67H	14	51-7/8"	1021989*	
Minn-Moline	SL-200	67H	14	37-1/2"	1021823	
Minn-Moline	100	67H	15	37"	1021666	
Minn-Moline	110	67H	14	47-1/2"	1021625*	
New Holland	200 Series, 300 Series, 135	67H	15	44-1/2"	1021575*	
New Holland	510, 511, 512	67H	14	56-1/16"	1023431*	
New Holland	513, 514	67H	14	59-1/8"	1023449*	
New Holland	513, 514	T-Bar	14	59-1/8"	1023456*	
New Holland	519, 520	Pintle	16	59-1/8"	1023464*	
New Holland	519, 520	T-Bar	16	59-1/8"	1023472*	
New Holland	675, 676, 677S, 677T	Pintle	22	56-1/16"	1022029*	
New Holland	679, 680	Pintle	22	59-1/8"	1023480*	
New Holland	679, 680	T-Bar	22	59-1/8"	1023498*	
New Idea	10A	67H	15	34-1/4"	1021732	
New Idea	12A, 17, 200, 208	67H	15	36-1/4"	1021542	
New Idea	14, 18	67H	12	34-1/4"	1021740	
New Idea	15, 19	67H	15	41-5/8"	1021559*	
New Idea	201, 203, 208	67H	15	48-1/2"	1021799*	
New Idea	202	67H	15	42-3/4"	1021872*	
New Idea	205, 207, 210	67H	20	48-1/2"	1021807*	
New Idea	205, 207, 210	Pintle	20	48-1/2"	1022037*	
New Idea	206	67H	13	37-3/4"	1021880	
New Idea	211	67H	11	50-3/4"	1023514*	
New Idea	212, 351A	67XH	15	50-3/4"	1021849*	
New Idea	212, 351A	T-Bar	15	50-3/4"	1023522*	
New Idea	213, 351B	67XH	19	50-3/4"	1022003*	
New Idea	214, 217	67XH	23	50-3/4"	1021856*	
New Idea	214, 217	T-Bar	23	50-3/4"	1023530*	
New Idea	218, 244	Pintle	23	62-1/2"	1023548*	
New Idea	218, 244	T-Bar	23	62-1/2"	1023555*	
New Idea	352, 362, 3622, 3722	T-Bar	19	58-1/4"	1023563*	
New Idea	353, 363, 3632, 3732	T-Bar	26	58-1/4"	1023571*	
New Idea	354, 364, 3639, 3739, 3743	T-Bar	26	62-1/2"	1023589*	
New Idea	361, 3618, 3718	T-Bar	14	50-3/4"	1023613*	
Oliver	490	67H	16	51-1/2"	1021930*	
Schultz	110, 2120	67H	13	48-3/4"	1021617*	



Many Other Chains are Available. Please call toll-free 1-800-247-2167 for pricing. Please have the width of the chain, number of slats and type of chain available when calling.

HERSCHEL TERMS AND CONDITIONS
Revisions Effective February 15, 2016

Terms Policy

These policies and procedures apply to purchases from Alamo Group (IA) Inc. here after referred to as "Herschel" by its customers. Herschel reserves the right to modify the terms and conditions. Please make all checks payable to Herschel and remit to:

Herschel P.O. Box 840341, Dallas, TX 75284-0341.

Net 10th of the month following shipment. Payments postmarked by the 10th will be considered on time. Any invoice not paid by the 10th of the month following shipment shall be deemed past due and shall be subject to the higher of a one and one-half percent (1-1/2 %) per month service charge until paid, or the maximum rate allowable by law. For accounts that have been turned over to collections: **All collection fees must be paid in full before account will be reactivated.**

Price Policy

1. All prices are net and subject to change without notice. Orders will be invoiced at the prices in effect at the time of shipment unless otherwise stated.

Order Types

UPS Orders -

Placed by 3 pm CST, ship same day

LTL Orders -

Shipped Next Day

Program Orders -

Please allow up to 30 days from receipt of order for shipments. This pertains to Early Order Program orders, Zappers and any other special promotion or lot pricing.

Freight Policy

UPS Ground Shipment Time From Indianola, IA 50125

ORDER VALUE	FREIGHT	COMMENTS
\$0-\$99.99	ACTUAL*	
\$100.00 - \$349.99	No Charge*	FRIDAY ONLY ORDERS VIA UPS GROUND.
\$350.00 - \$749.99	No Charge*	SHIPMENTS VIA UPS GROUND. QUALIFIED STOCKING DEALERS ONLY (ASK FOR DETAILS).
\$750.00 - \$1499.99	No Charge*	SHIPMENTS VIA UPS GROUND.
\$1500.00 and UP	No Charge*	SHIPMENTS VIA UPS GROUND OR TRUCK.

*All back orders are shipped at original freight terms.

- UPS MAXIMUM 4 PACKAGES AT 70# IF CUSTOMER IS PAYING ACTUAL FREIGHT
- HERSCHEL RESERVES THE RIGHT TO SHIP FREE FREIGHT ORDERS VIA CARRIER OF OUR CHOICE
- ADDITIONAL FREIGHT CHARGES APPLY TO ALL 1-PIECE SICKLES 20' AND OVER
- DROP SHIP PRODUCTS ALL SHIPPED ACTUAL FREIGHT
- NO SERVICE CHARGES OR SURCHARGES WILL APPLY TO ANY ORDER



Freight and Ground Claims

Before signing a Bill of Lading or carrier delivery sheet, inspect shipment for any signs of damage (visible or concealed) or product shortages. **If damages or shortages are evident, have the carrier's driver sign to acknowledge and note them on the Bill of Lading.** You must then initiate a claim with the carrier. If damages or shortages are not noted on the Bill of Lading, the carrier no longer has the risk of loss, and you become solely responsible for all damages or shortages. Any claims involving concealed damage, shortages or wrong parts not reported within 14 days of invoice will not be honored by Herschel. **Under no circumstance should a customer refuse a shipment without contacting Herschel Customer Service.**

Return Policy

- All returns must be accompanied by the corresponding RMA paperwork, detailing the specified, authorized products. Returns failing to have this paperwork will be sent back to you at your expense. RMA's may be obtained by calling customer service.
- Returns in new, resalable condition received within 30 days of shipment will receive full credit, with the following exception: Items returned due to customer error will be charged a 15% restocking fee and pre-paid freight will be charged back.
- Freight charges will be credited on all returns due to a Herschel error. The customer will be responsible for freight charges on returns due to customer errors.

Exceptions - Products coded with "NR" in the price book, special order items and hazardous material are non-returnable. Gasket sets that have been opened as well as electrical components that have been installed are also non-returnable unless defective.

Limited Warranty

Herschel warrants products it manufactures to be free of material defects in workmanship and materials at the time of manufacture. Products sold by Herschel, but produced by manufacturers other than Herschel, are warranted only to the extent of the manufacturer's warranty. The Herschel warranty applies only to products properly installed and operated under normal conditions. This warranty does not cover diagnosis or installation labor. If, in the judgment of Herschel, a product has been altered in any way, misused, improperly installed, or fails to perform satisfactorily due to operator error, this warranty shall be void. Herschel is not liable for damages from or to equipment, damage to any property, personal injury (including death) or economic loss which results from purchase or use of any product sold or provided by Herschel. Herschel will repair or replace, at its option, any defective products as provided below. **THIS WARRANTY IS THE ONLY WARRANTY PROVIDED ON THE PRODUCTS. HERSCHEL DISCLAIMS ANY EXPRESS OR IMPLIED WARRANTIES WITH RESPECT TO THE PRODUCTS INCLUDING, BUT NOT LIMITED TO WARRANTIES OF MERCHANTABILITY AND FITNESS FOR A PARTICULAR PURPOSE.**

TERMS OF COVERAGE:

Tractor Parts - All New and Rebuilt tractor parts are guaranteed for materials and workmanship for 1-year from the date of shipment for replacement or refund unless otherwise noted.

This warranty does not include costs incurred for third parties for additional parts or labor involved in the repair. This warranty applies only to farming applications. Products used for other applications, including, but not limited to industrial and other commercial applications, are not covered by this express warranty, nor are they covered by express or implied warranties of merchantability or fitness for a particular purpose. Guaranteed for applications listed only; void for other applications. The above express limited warranties are given in place of any and all other warranties, expressed or implied, including merchantability or fitness for a particular purpose, and such express warranties constitute the only warranties made.

Tillage Parts - 90 days from the date sold to end user

Plow Shares manufactured by Herschel carry a 100% warranty if share measures over 4-1/8" wide behind the first bolt hole, or a 50% warranty if share measures 4" - 4-1/8". Shares worn to less than 4" are not covered under warranty. Hard faced shares operated in rocky conditions as determined by Herschel are not covered under warranty.

Cutting Parts - 90 days from the date sold to end user

Sickle failure due to head breakage - Herschel will repair or replace only the head, not the entire sickle.

Limitation of Liability

The customer must show proof of purchase from Herschel and proof of sale to the end-user on all warranty claims. All warranty claims must be directed to Herschel headquarters in Indianola, Iowa. Herschel may require parts listed on warranty claims to be returned to Herschel for inspection. Do not ship warranty parts back unless requested to do so. This warranty is limited to replacement of parts purchased, or a refund of the purchase price plus the cost of surface ground shipment or freight charges. EXCEPT AS PROVIDED HEREIN, HERSCHEL SHALL HAVE NO LIABILITY OR RESPONSIBILITY TO PURCHASER, END-USER, OR ANY OTHER PERSON OR ENTITY WITH RESPECT TO ANY LIABILITY, LOSS OR DAMAGE CAUSED OR ALLEGED TO BE CAUSED DIRECTLY OR INDIRECTLY BY THE PRODUCTS PROVIDED OR SOLD BY HERSCHEL, INCLUDING, WITHOUT LIMITATION, ANY INDIRECT, SPECIAL, CONSEQUENTIAL, OR INCIDENTAL DAMAGES RESULTING FROM THE PURCHASE, USE OR OPERATION OF THE PRODUCTS OR ANY BREACH OF THIS OR ANY OTHER WARRANTY. NOT WITHSTANDING THE ABOVE LIMITATIONS AND WARRANTIES, HERSCHEL'S LIABILITY FOR DAMAGES INCURRED BY PURCHASER, END-USER, OR ANY OTHER PERSON OR ENTITY SHALL NOT EXCEED THE PRICE OF THE PRODUCTS.

HEEL SWEEP

Thickness: 1/4"
Width: 18"
Shank: 50 degrees
Holes: 2 holes 1/2" slotted
Hole Spacing: 2-1/4" to 2-1/2"

Order No. HEEL18

Application: Fits over top of a chisel plow shank and is used in conjunction with a chisel point being bolted on over the top of this heel sweep. Our CB75 or HA13S would be popular choices for this.

Benefits: Provides cultivating and chiseling in the same pass. It can also be used in manure application in some areas.



V-SHOT

- V-Slice proven technology, improving seed-soil contact.
- Uniform and early emergence, eliminate seed roll-and-bounce.
- Apply starter fertilizer where it belongs, below the seed.

Priced and sold per box of 4.

Make	Model	Order No.
JD	XP, XP Pro, ME5 Row Unit	HVSHOT1985
JD	1986 - 2005 Max Emerge, ME Plus Row Units	HVSHOT1785



LED LIGHTS

- Lifetime Warranty
- Made In USA
- 3X More Housing Surface For Maximum Cooling.
- Up To 50,000+ Hour Lifespan
- 9 - 36 Volt
- Reverse Polarity
- 20' Wire Harness With Rocker Switch
- Waterproof Deutsch Connector
- -40° F to 145° F Operating Temp



See Page 173 For Details



AEROSOLS

- Agricultural/Industrial Strength
- OE Formulas
- Satisfaction Guaranteed



See Page 183 For Details



HERSCHEL

Manufacturing Quality Ag Parts Since 1887

1301 N 14TH STREET • INDIANOLA, IA 50125

Customer Number:



HERSCHEL

Manufacturing Quality Ag Parts Since 1887

HARVESTING
HAY/FORAGE
FARM SUPPLIES
PLANTER PARTS
TILLAGE TOOLS

CATALOG

PHONE: 800-247-2167 • FAX: 800-524-7481

WWW.HERSCHELPARTS.COM

HERSCHEL is The Exclusive Distributor Of The Following Brands:

**ADAMS[®]
HARD-FACING**

**TERMINATOR
SWEEPS**



**TIGER
JAWS**
2000

